



Door Hardware Catalogue

BINDER PREPARED

TABLE OF CONTENTS

Our Company	i
Our Project Services	iii
Terms & Conditions	v

SECTION 1 DOOR LOCKS

COMMERCIAL LOCKSETS	
DOREX F1 Series, Cylindrical, Lever, Grade 1 BHMA	01.010
DOREX GX1 Series, Cylindrical, Lever, Grade 1 BHMA	01.012
DOREX F Series, Cylindrical, Lever, Grade 2 BHMA	01.020
DOREX T2 Series, Cylindrical, Lever, Grade 2	01.021
DOREX RW Series, Cylindrical, Lever, Grade 2	01.023
DOREX CW Series, Cylindrical, Lever, Grade 2	01.024
DOREX E Series, Cylindrical, Lever, Grade 2	01.026
DOREX GX1B Series, Cylindrical, Knob, Grade 1	01.030
DOREX TL Series, Cylindrical, Knob, Grade 2	01.032
DOREX T2B Series, Cylindrical, Knob, Grade 2	01.034
DOREX IL Series, Interconnected Cylindrical, Lever, Grade 2	01.040
DOREX T2IL Series, Interconnected Tubular, Lever, Grade 2	01.042
DOREX GX1A Series, Deadbolt, Grade 1	01.050
DOREX FHA Series, Deadbolt, Grade 2	01.052
DOREX TLA Series, Deadbolt, Grade 2	01.054
DOREX DG1 Series, Gate Latch, Grade 1	01.060
DOREX DG2 Series, Gate Latch, Grade 2	01.062
MORTISE LOCKSETS	
DOREX DM Series, Mortise, Grade 1 BHMA	01.070
DOREX DMDBL Series, Mortise Deadbolt, Grade 1	01.074
RESIDENTIAL LOCKSETS	
DOREX Tecnica Design, Grade 3	01.200
DOREX Signature, Grade 3	01.240
DOREX Metro	01.260
DOREX Builder	01.280
Pocket Door locks	01.300
ELECTRONIC & COMBINATION LOCKSETS	
DOREX F400T Series, Deadbolt, RFID, Electronic Touch Keypad, Grade 2	01.400
DOREX F425T Series, Lever, RFID, Electronic Touch Keypad, Grade 2	01.402
DOREX F500T Series, Smart Electronic Deadbolt, Grade 2	01.405
ER Series, Deadbolt, Electronic Keypad	01.410
DOREX F500 Combo Electronic Entry Handleset	01.415
DOREX T300 Combo Electronic Entry Handleset	01.416
DDL 1150 Series, Lever, Mechanical Keypad	01.420
DDL 2200 Series, Knob, Mechanical Keypad	01.422
PATCH FITTING LOCKSETS	
PF Series, Patch Fitting, Lever	01.500
PF Series, Patch Fitting, Deadbolt	01.510
DOREX PLH900 Series, Universal Patch Lock & Strike Housing	01.520

SECTION 2 EXIT DEVICES

PUSH PAD EXIT DEVICES	
DOREX DX1 Series, Grade 1 BHMA	02.010
DOREX 9500 Series, Grade 1 BHMA	02.020
DOREX 8500 Series, Grade 2	02.030
D8DIVISION8 8000 Series, Grade 2	02.032

TABLE OF CONTENTS

DOREX DX2 Series, Narrow Stile, Grade 1 BHMA	02.100
1400 Series, Narrow Stile – Mortise	02.110
2295 Series, Narrow Stile	02.120
CROSSBAR EXIT DEVICES	
DOREX NH900 Series, Grade 2	02.200
DOREX 1100 Series, Narrow Stile	02.210
SECTION 3 DOOR CONTROL	
<hr/>	
SURFACE DOOR CLOSERS, ADJUSTABLE POWER	
DOREX 441HD Series, Heavy-Duty, Grade 1	03.005
DOREX 441 Series, Grade 1	03.006
DOREX 1901 Series, Grade 1 BHMA	03.010
DOREX 1900 Series, Grade 1	03.011
DOREX 1701 Series, Grade 1 BHMA	03.022
DOREX 1700 Series, Grade 1	03.024
DOREX 1761 Series	03.026
DOREX 851 Series, Grade 1 BHMA	03.030
SURFACE DOOR CLOSERS, FIXED POWER	
DOREX 700 Series	03.040
D8DIVISION8 300 Series	03.044
D8DIVISION8 DC300 Series	03.045
TC603 Series	03.046
CONCEALED DOOR CLOSERS	
DOREX DC3000, Concealed in door	03.051
DOREX 30, Concealed in transom	03.052
DOREX 40, Concealed in floor	03.054
PERKO, Concealed Door Closers	03.056
PF100 Hydraulic Patch Fitting Closer	03.060
PF102 Hydraulic Patch Fitting Closer	03.062
Auxiliary Door Check	03.072
Overhead Holders & Stops	03.100
Door Coordinators	03.200
Electromagnetic Door Holders	03.300
SECTION 4 COMMERCIAL & RESIDENTIAL HINGES	
<hr/>	
COMMERCIAL HINGES	
DOREX BB1079, Full Mortise, Ball Bearing	04.016
DOREX CB1079, Full Mortise, Concealed Ball Bearing	04.018
DOREX PRO 1168, Full Mortise, Heavy Duty Ball Bearing	04.020
DOREX 1198, Full Mortise, Heavy Duty Ball Bearing	04.021
DOREX BB1068, Full Mortise, Heavy Duty Ball Bearing	04.022
DOREX 143, Full Mortise, Plain Bearing	04.031
DOREX BB1073, Half Surface, Ball Bearing	04.041
DOREX BB1077, Half Mortise, Ball Bearing	04.046
DOREX BB1048, Swing Clear, Ball Bearing	04.051
DOREX 1265, Reinforcement Hinge	04.060
Reinforcement & Filler Plates	04.065
DOREX 3310, Single Acting Spring Hinge	04.070
1310, Single Acting Spring Hinge	04.071
Commercial Spring Hinges	04.075
DOREX 1020, Universal Replacement Hinge	04.080



TABLE OF CONTENTS

Residential Hinges.....04.100
 Continuous Geared Hinges **BHMA**.....04.200
 Pivots.....04.300
 Glass Patch Fittings.....04.400
 Assorted.....04.500
 Specialty.....04.600

SECTION 5 SECURITY HARDWARE

PADLOCKS & ACCESSORIES
GUARD Padlocks.....05.010
 Padlocks.....05.020
VIRO Padlocks.....05.040
 Specialty Padlocks.....05.060

STOREFRONT HARDWARE
DOREX Mortise Locks.....05.200
VIRO Mortise Locks.....05.200
 Door Handles & Paddles.....05.240
 Electric Strikes.....05.260

LOCK CYLINDERS
 Mortise Cylinders.....05.400
 Rim Cylinders.....05.410
 Cylinder Trim Rings.....05.420
 Guards & Latch Protectors.....05.430
 Profile Cylinders.....05.440

DOOR SECURITY
 Door Viewers.....05.600
 Door Guards & Chains.....05.610
 Rim Locks.....05.630
 Door Protection.....05.640

Assorted Small Locks.....05.700
 Key Accessories.....05.800

SECTION 6 GENERAL HARDWARE

DOOR PULLS, HANDLES & PLATES
 Door Pulls.....06.010
 Flush Pulls.....06.025
 Edge Pulls.....06.030
 Multi-purpose Pulls.....06.040
 Pull Plates.....06.050
 Push & Kick Plates.....06.060
 Kick, Push & Back Plates.....06.061

DOOR STOPS & HOLDERS
 Door Stops.....06.110
 Door Holders.....06.150
 Check Chains.....06.160

DOOR ACCESSORIES
 Letter Slots.....06.200
 Signage.....06.220
 Weather Stripping and Gasketing.....06.250

TABLE OF CONTENTS

HASPS & BOLTS	
Flush Bolts.....	06.300
Surface Bolts.....	06.320
Tower Bolts.....	06.330
Padbolts.....	06.340
Safety Hasps.....	06.350
TRIMMER HARDWARE	
Closet Hardware.....	06.510
Wardrobe Hooks.....	06.520
Handrail Brackets.....	06.530
Door Catches & Latches.....	06.540
LAVATORY HARDWARE	
Lavatory Partition Hardware.....	06.600
Bath Hardware.....	06.610
CABINET HARDWARE	
Magnetic Catches.....	06.700
Ball & Roller Catches.....	06.710
Reinforcement Hardware.....	06.740
SLIDING HARDWARE	
Sliding Door Hardware.....	06.810
By-Pass Door Hardware.....	06.820
Bi-fold Door Hardware.....	06.830
Sliding Tracks.....	06.840
Accessories.....	06.850
WINDOW HARDWARE	
Window Hardware.....	06.900

SECTION 7 APPENDIX

Canaropa has partnered with many quality manufacturers of door hardware from all over the world. Contact your local representative for special orders from these and other fine manufacturers mentioned in our catalogue.

ABH Architectural Door Hardware BHMA	A.030
BOMMER Hinges.....	A.100
CX5 SECURITY SOLUTIONS High Security Cylinders.....	A.180
CAMDEN DOOR CONTROLS Electrified Door Hardware & Access Control.....	A.300
SIGMA AUTOMATICS Swing Door Operators.....	A.350
NGP (NATIONAL GUARD PRODUCTS) Thresholds, Gaskets, Sweeps and more BHMA	A.600
PERKO Concealed Door Hardware.....	A.770
SOSS Concealed Hinges.....	A.870
VIRO Security Hardware.....	A.920



The Door Hardware Professionals

Canaropa is a Canadian-owned and operated leading contract manufacturer, importer and distributor of quality commercial, residential and architectural door hardware. The preferred choice of professionals, developers and architects – our products are found throughout North America in private homes, residential developments, offices, commercial and industrial buildings and resorts.

Canaropa offers an extensive selection of reliable, quality door hardware, including door closers, locks, hinges, exit devices, security hardware and more. Coupled with national offices, warehouses, and large inventory, we provide fast and reliable service to our customers from coast to coast.

Canaropa is also proud to offer DOREX, its in-house brand of high-quality door hardware. Recognized as the "The Reliable Choice", DOREX is trusted by door hardware professionals for its durability, performance, and value. As a proudly Canadian brand, DOREX reflects Canaropa's dedication to excellence in door hardware solutions.

Since 1954, Canaropa has been focused on delivering the best possible service to its customers. With our dedicated team of experienced door hardware professionals, management and sales teams – we work hard to meet the needs of our customers by developing new products, delivering consulting services and staying current with trends in the market.

Throughout 70+ years in business, Canaropa is grateful to have developed many valued relationships with customers and suppliers alike. Building on this history, we look forward to a future of continued success.



MONTREAL

1725 50th Avenue
Lachine, QC H8T 3C8

t 514.636.6466
f 514.636.0961
toll free 1.888.636.6466

TORONTO

1866 Kipling Avenue
Toronto, ON M9W 4J1

t 416.241.4445
f 416.241.1989
toll free 1.800.707.7707

CALGARY

3015 16th Street NE
Calgary, AB T2E 7K8

t 403.250.9333
f 403.250.1160
toll free 1.877.852.1954

VANCOUVER

11615 Industrial Ave, Unit 100
Port Coquitlam, BC V3C 6M9

t 604.279.2524
f 604.279.0577
toll free 1.877.279.2262



Complete Hardware Solutions

With an emphasis on customer satisfaction, we offer more than a complete array of products, but services that compliment it.

Our door hardware specialists provide the architectural and design communities with responsive, professional and comprehensive technical, product and project planning support and services.

Our complete inventory of products and experience means that we're able to deliver complete solutions that fit all budget and building requirements.

We're dedicated to becoming your door hardware partner, we believe that your success is our success.

COMMON
AREAS

RESIDENTIAL
SUITE ENTRY

RESIDENTIAL
INTERIORS

OFFICE
SPACES

COMMERCIAL/
STOREFRONT

PUBLIC
ENTRY



Project Support Services

Our project consultants provide architects, designers and developers comprehensive consultation services for commercial, residential, industrial, institutional, or hybrid projects of all sizes and scopes.

ARCHITECTURAL HARDWARE SPECIFICATIONS

- Consultative services with Designers and Owners to establish project requirements and security coordination.
- Writing, editing and/or converting specifications and hardware schedules.
- Assist in the development and planning of a secure keying system.

GENERAL SERVICES

- Project coordination to ensure the smooth running of your projects, our team works closely with the various internal and external stakeholders involved in the project.
- Budget preparation
- Review substitution requests
- Consult on architectural hardware, doors and frames and glass doors.
- In-house keying services provided by certified locksmiths.

Whether it's a small residential project or a multi-building development — Canaropa's hardware professionals can help guide you through the hardware specification process in order to achieve an accurate and compliant door schedule.

Our experienced hardware professionals are happy to help. They are well versed on local and national building codes, the unique needs of various types of facilities and egress requirements.

Take advantage of our experience and product knowledge today.



Eau du Soleil, Toronto



Pusateri's Food Hall, Toronto



Evolo, Montreal



Genco, Calgary



Griffintown, Montreal



M1 / M2, Vancouver



Oronoco, Maryland USA



Verve, Calgary



Norfolk, DC USA

TERMS & CONDITIONS

Note: The words merchandise, item(s), product(s), goods, and stock are used interchangeably and imply that they are regularly stocked.

PRICES Prices are FOB shipping point and may change without notice. Shipment(s) costs will be determined at the time of shipping. Prices quoted for projects are valid for 30 days or as per the date indicated on the written quotation issued by Canaropa.

Whenever possible, Canaropa will provide price protection for orders. All prices are subject to G.S.T. or H.S.T. and/or P.S.T. as applicable and do not include shipping charges.

TERMS OF PAYMENT Unless otherwise specified, terms are "Net 30 Days" from the date of shipment with approved credit only. An administration charge of 2% per month will apply to all overdue accounts. Without approved credit or prepayment, a certified payment must accompany the order. All invoice totals are the legal entitlement of Canaropa until paid.

MINIMUM ORDER Minimum order amounts must be at least \$100.00 per invoice net, before taxes.

SHIPPING Please refer to Shipping Policy (see page VI).

BACKORDERS Stock items on back order will be shipped prepaid as soon as possible at contracted prices. Items that are unavailable at the time of shipping will be automatically back ordered. If backorders are not required or accepted, it should be specified in the order or on the order confirmation.

CLAIMS Claims for item(s) shipped in error, damaged item(s), item(s) shortages, etc. must be reported within 30 days after receipt of goods.

Claims for labour or unauthorized charges will NOT be accepted.

RETURN GOODS POLICY Returns will not be accepted unless a Return Authorization document including a Return Authorization Number (RMA#) has been issued by Canaropa. Any request to return goods to Canaropa MUST be in writing with all the pertinent information provided on the Return Merchandise Request form or RMR form. Upon receipt of the completed form and requested information, Canaropa will issue a Return Authorization document, including a RMA# and instructions for the return of the goods. All returned merchandise must be unused, in the original packaging, and unmarked. Returned merchandise must be accompanied by the Return Authorization document issued by Canaropa; the returned merchandise must be received by Canaropa within 30 days from the RMA# issue date. A restocking fee of 25% for Canaropa brands and 50% for partner products or a minimum of \$100.00 will be charged on goods returned as "not wanted" or "incorrectly ordered." Canaropa must be informed within 30 days of receipt of goods for an RMA number to be granted for incorrectly ordered or unwanted merchandise. No returns will be accepted after 60 days from RMA issued date. All items returned as defective are subject to inspection. All special (non-stock, or customer-specific) item(s) are NON-returnable, NON-refundable, and NON-exchangeable, as per section SPECIAL ORDERS below. If the special item(s) are deemed to be defective and confirmed by Canaropa, they may only be exchanged for the same product. Canaropa's customers are responsible for all return freight charges. However, a credit will be issued for all reasonable and customary freight charges relevant to that item only if the wrong item was shipped by Canaropa. Customer-specific item(s) made specifically to customer's specifications, i.e., custom keying and/or locksmithing work, are NON-returnable, NON-refundable and NON-exchangeable.

Canaropa will notify their customers via email, phone or fax of credit once Canaropa receives and processes the returned item(s). Please note that Canaropa will credit reasonable shipping costs only if the return is a result of an error by Canaropa or the warranty claim for the item(s) returned has been accepted. Please allow 10 to 15 business days for processing the return. If the payment was made by credit card, the credit would be credited to the original credit card account number only.

The RMR Forms can be downloaded from www.canaropa.com

SPECIAL ORDERS Special Order Items include all non-stock items and modified items, including all services and item re-configurations, specifically requested or ordered by the customer even if the item is featured in any Canaropa literature or websites. All items determined to be a Special Order, once ordered, can NOT be cancelled and are NON-returnable and NON-refundable. Special Order Items deemed defective by Canaropa will be exchanged for the same product.

OUR COMMITMENT TO QUALITY The quality of all hardware distributed by Canaropa is inspected, reviewed and upgraded on a continuous basis. To maintain our commitment to quality, Canaropa reserves the right to make design and/or technical changes at any time. Specifications for any item may vary from those listed in the catalogue or other publications, and from previous specifications.

WARRANTY AND LIABILITY All Canaropa items are carefully selected and guaranteed to be free from defects in workman-ship, for a maximum period of 1 year or otherwise specified on a per product basis. Other warranties are issued separately for different products from different manufacturers. Our sales department can assist with warranty information for specific products. Our warranty covers free replacement or credit of such warranted items only; in case the warranted product is discontinued a compatible product will be issued. Canaropa cannot guarantee replacement or credit; however, a warranty repair may be given. Any item returned under warranty may be repaired, replaced or credited at the sole and absolute discretion of Canaropa. No Warranty claim will be accepted without authorization.

Canaropa does NOT accept any liabilities for damages and/or labour claims for damage incurred on or as a result of the use or installation of the products and or work done thereto as a result. Canaropa is NOT responsible for improper use of the product beyond the limits for which it was designed; and shall NOT, in any case, be liable for public, incidental or consequential damages of any kind. No other guarantees exist or are otherwise implied.

ACCEPTANCE OF ORDER Canaropa reserves the right to decline an order, in whole or in part, when the price, quantity, or assortments of goods are NOT satisfactory to Canaropa.

FORCE MAJEURE Canaropa is NOT liable for any failure and/or delay in supply or delivery or of any damage or defects to goods supplied or delivered hereunder that is caused by an event or circumstance beyond our reason-able control (including, without limitations, strikes, lockouts and other industrial disputes).

CHANGES TO PRODUCTS Canaropa makes every effort to ensure that product descriptions in our catalogues, brochures, and website are accurate. However, some inaccuracies, typographical errors or misinterpretations may occur. Canaropa reserves the right to correct such inaccuracies or typographical errors as they are identified. All depictions contained in our catalogues, brochures, and website are for illustration purposes only. Because of differences in picture inks, computer monitors, and printer ink, colours of the actual product may vary slightly from those observed in any media format.

DISCLAIMER WARNING Some, or even all data extracted from our catalogues, brochures or product information booklets or sheets, specifications, technical documents or any other source, may NOT accurately depict the product in its latest configuration. Therefore, it is essential and your responsibility to request that the latest revision/configuration of product information is supplied at the time the order is placed.

THE TERMS AND CONDITIONS IN THIS DOCUMENT SUPERSEDE ALL PRIOR WRITTEN OR ORAL COMMUNICATIONS RELATED TO THE PRODUCTS AND SERVICES HEREIN. EFFECTIVE MAY 1ST 2025.

SHIPPING POLICY

Unless otherwise stated, all shipments are FOB shipping point. Shipping destinations are expected to have dock level access at a commercial facility, and open to receive freight during normal business hours without appointment. Requests for liftgate service, or other special shipping instructions, must be noted on your purchase order.

COLLECT SHIPMENTS We accept orders to ship via your specified carrier, when accompanied with your carrier account number. Contact our Customer Service department for shipping requirements, or transportation alternatives. For collect shipments, any claims for visible damage, concealed damage, incorrect delivery, or loss of package directly with the carrier.

PREPAY & CHARGE For orders confirmed prepay & charge, the transportation fees are calculated based on actual dimensions, weight, and distance as well as the carrier and shipping service selected by Canaropa. Surcharges may apply.

PREPAID SHIPMENTS Accounts eligible for prepaid shipping are subject to the following conditions:

1. Each order must meet or exceed the minimum order value determined by our Customer Service Department. The minimum order value is based on supplying warehouse, and the ship-to location.
2. Irregular item assortments that are overweight (such as bulk-pack hinges) or oversized (such as track/closet rods) may, at our discretion, be disqualified from prepaid shipping.
3. Surcharges (see below), remain the responsibility of the customer and may be charged on qualifying prepaid shipment orders.

Orders related to warranty claims, errors, or backorders will be prioritized to ship with other goods or shipped prepaid when appropriate.

SURCHARGES Any extra charges incurred for additional services are the responsibility of the customer and may be included on the order invoice or a subsequent invoice. Common shipping surcharges include:

- Liftgate service.
- Delivery Area or Residential surcharges.
- Appointment-based, Call-ahead,
- Construction Site, or Saturday deliveries.
- Additional Handling or Undeliverable package fees.

SHIPMENT VERIFICATION AND INSPECTION

1. **VERIFY:** Verify the total number of cartons/pallets received matches the carrier's Bill-of-Lading.
2. **INSPECT:** Inspect for visible damage looking for cartons with damaged corners, torn or punctured cardboard, and/or pallets with signs of stacking, excessive weight, or forklift damage.
3. **DOCUMENT:** Document any count or damage concerns on the delivery receipt with notes that are as specific as possible. Take photos where appropriate, and do not discard any damaged products or packaging until directed to do so by Customer Service.
4. **REPORT:** Report to our Customer Service team any shipping loss or damage within (30) days of receipt of goods. Claims reported after (30) days will be subject-to the Carrier's bill-of-lading terms, conditions and claim handling policies.

EFFECTIVE MAY 1ST 2025.





DOOR LOCKS TABLE OF CONTENTS

Door Handing Guide.....	ii
Finish Guide.....	ii
Abbreviation Guide.....	iii
Function Guides.....	iv

COMMERCIAL LOCKSETS

DOREX F1 Series, Cylindrical, Lever, Grade 1 BHMA	01.010
DOREX GX1 Series, Cylindrical, Lever, Grade 1 BHMA	01.012
DOREX F Series, Cylindrical, Lever, Grade 2 BHMA	01.020
DOREX T2 Series, Cylindrical, Lever, Grade 2.....	01.021
DOREX RW Series, Cylindrical, Lever, Grade 2.....	01.023
DOREX CW Series, Cylindrical, Lever, Grade 2.....	01.024
DOREX EM Series, Cylindrical, Lever, Grade 2.....	01.026
DOREX GX1B Series, Cylindrical, Knob, Grade 1.....	01.030
DOREX TL Series, Cylindrical, Knob, Grade 2.....	01.032
DOREX T2B Series, Cylindrical, Knob, Grade 2.....	01.034
DOREX IL Series, Interconnected Cylindrical, Lever, Grade 2.....	01.040
DOREX T2IL Series, Interconnected Tubular, Lever, Grade 2.....	01.042
DOREX GX1A Series, Deadbolt, Grade 1.....	01.050
DOREX FHA Series, Deadbolt, Grade 2.....	01.052
DOREX TLA Series, Deadbolt, Grade 2.....	01.054
DOREX DG1 Series, Gatelatch, Grade 1.....	01.060
DOREX DG2 Series, Gatelatch, Grade 2.....	01.062

MORTISE LOCKSETS

DOREX DM Series, Mortise, Grade 1 BHMA	01.070
DOREX DMDBL Series, Mortise Deadbolt, Grade 1.....	01.074

RESIDENTIAL LOCKSETS

DOREX Tecnica Design, Grade 3.....	01.210
DOREX Signature, Grade 3.....	01.230
DOREX Metro.....	01.240
DOREX Builders.....	01.260

MISCELLANEOUS LOCKSETS

Pocket Door Locks.....	01.300
------------------------	--------

COMBINATION LOCKSETS

DOREX F400T Series, Deadbolt, RFID, Electronic Touch Keypad, Grade 2.....	01.400
DOREX F425T Series, Lever, RFID, Electronic Touch Keypad, Grade 2.....	01.402
DOREX F500T Series, Smart Electronic Deadbolt, Grade 2.....	01.405
ER Series, Deadbolt, Electronic Keypad.....	01.410
DOREX F500 Combo Electronic Entry Handleset.....	01.415
DOREX T300 Combo Electronic Entry Handleset.....	01.416
DDL 1150 Series, Lever, Mechanical Keypad.....	01.420
DDL 2200 Series, Knob, Mechanical Keypad.....	01.422

PATCH FITTING LOCKSETS

PF Series, Patch Fitting, Lever.....	01.500
PF Series, Patch Fitting, Deadbolt.....	01.510
DOREX PLH900 Series, Universal Patch Lock & Strike Housing.....	01.520





DOREX

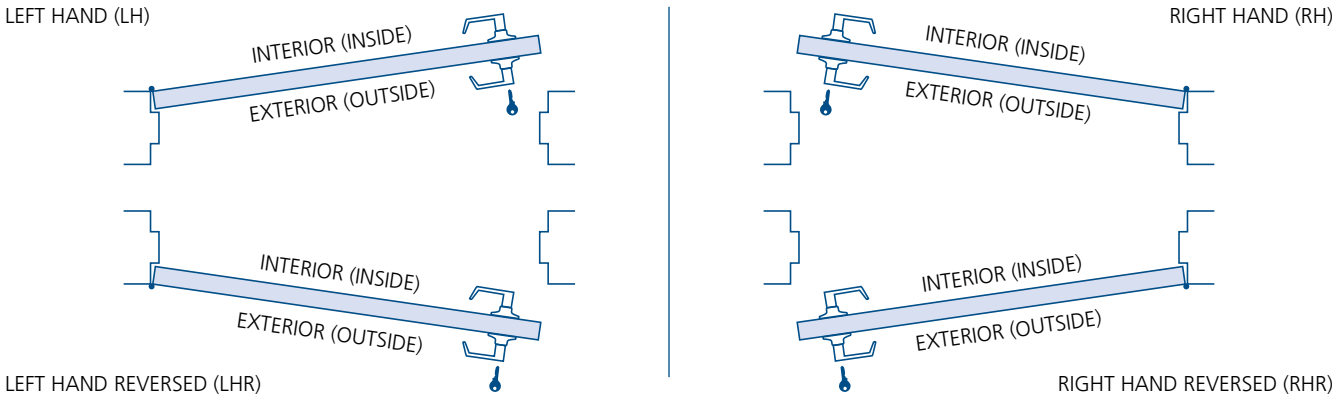

DOOR HANDING GUIDE



FINISH GUIDE

				
POLISHED BRASS	POLISHED BRASS (ENDURANCE)	SATIN BRASS	ANTIQUÉ BRASS	SATIN BRONZE
CODE BP, C3, 3	V3	C4, 4, SDB	AB, C5, 5	C10, 10
BHMA* 605, 632		633	609, 638	639
				
OIL RUBBED BRONZE⁽¹⁾	ANTIQUÉ BRONZE	POLISHED NICKEL	SATIN NICKEL	ANTIQUÉ NICKEL
CODE C10B, 10B	C11P, 11	C14, 14	SDN, C15, 15	C15A, 15A
BHMA* 640	617, 644	645	619, 646	620, 647
				
MATTE BLACK	DARK BRONZE / DURANODIC	POLISHED CHROME	SATIN CHROME	POLISHED STAINLESS STEEL
CODE C19, 19	BLR, DU, C20D, 20D	C26, 26	C26D, 26D	C32, 32
BHMA* 622, 631	649, 650, 690	625, 651	626, 652	629
				
SATIN STAINLESS STEEL				
CODE SS, C32D, 32D				
BHMA* 630				

ALL FINISHES IMAGES ABOVE ARE PHOTOGRAPHIC OR COLOUR APPROXIMATIONS, DELIVERED PRODUCT MAY VARY IN COMPARISON OR BETWEEN ORDERS/LOTS.
OTHER FINISHES AVAILABLE—PLEASE CONTACT.
 (*) EQUIVALENT; CODES DIFFER DEPENDING ON BASE MATERIAL AND/OR FINISH PROCESS.
 (1) OIL RUBBED BRONZE IS A «LIVING FINISH» WHOSE APPEARANCE WILL CHANGE OVER TIME.















DOOR LOCKS GENERAL INFORMATION

ABBREVIATION GUIDE

GENERAL











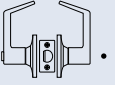

BS	Backset
DIA, Ø	Diameter
KG	Kilograms
LBS	Pounds
LH	Left hand
LHR	Left hand reversed
MAX	Maximum
MIN	Minimum
N/A, —	Not applicable / Not available
QTY	Quantity (usually followed by notes)
RH	Right hand
RHR	Right hand reversed
SQ, ▣	Square
WT	Weight
/UNIT	Number of items per basic unit of sale (bagged or boxed)
/BOX, /BAG	Number of UNITS found in an inner carton or bag
/CASE	Number of BOXES or UNITS found in an outer (shipping) carton

LEGEND

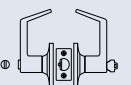
  	FIRE RATED product. Sometimes includes duration of fire-resistance in minutes (M) or hours (H).
	Small or Large Format Interchangeable Core (SFIC/LFIC) model or option available.
	Keyed product or function. Keying services may be available.
	Product, configuration or option meets ADA (Americans with Disabilities Act) requirements.
	GRADE 1 product meets or exceeds standardized testing requirements for high traffic, commercial applications.
	GRADE 2 product meets or exceeds standardized testing requirements for moderate traffic, commercial applications.
	GRADE 3 product meets or exceeds standardized testing requirements for light traffic, commercial or residential applications.
	Tested to Canadian and/or American safety and performance standards by Underwriters Laboratories® (UL).
	Certified by the Builders Hardware Manufacturers Association® / American National Standards Institute®.
	Product is equipped with or works with Radio-frequency Identification (RFID) readers or tags.
  	Limited warranty length in years, applicable to mechanical, electronic, or finish aspects of a product.

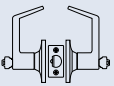
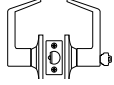
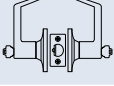
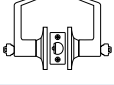

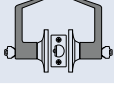
DOOR LOCKS GENERAL LOCKSET FUNCTION GUIDE

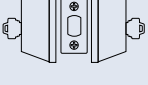

FUNCTION	DESCRIPTION	ANSI	INSIDE / OUTSIDE
10 PASSAGE	Latch bolt operated by lever from either side.	F75	
15 EXIT	Deadlocking latch bolt operated by inside lever. Blank plate on outside.	—	
17 SINGLE DUMMY 00	Lever and rose for one side of door to match other locksets.	—	
32 PATIO	Deadlocking latch bolt operated by lever from either side, except when inside push button locks outside lever. Push button released by turning inside lever or closing door to prevent lock-out.	F77	
42 PRIVACY 40	Latch bolt operated by lever from either side, except when inside push button locks outside lever. Push button released by turning inside lever or closing door to prevent lock-out. Outside lever has provision for emergency unlocking.	F76	
51 ENTRY, OFFICE	Deadlocking latch bolt operated by lever from either side, except when inside push button locks outside lever. Push button released by turning inside lever. Outside lever is unlocked / locked by key.	—	
52 ENTRY	Deadlocking latch bolt operated by lever from either side, except when inside button is pushed and turned (with tool) to lock outside lever for entry by key only. Outside lever remains locked until push button is turned.	F109	
53 ENTRY	Deadlocking latch bolt operated by lever from either side, except when inside button is pushed and turned to lock outside lever for entry by key only. Outside lever remains locked until push button is turned.	F109	
60 STORE	Deadlocking latch bolt operated by lever from either side. A key used on either side locks or unlocks both sides. NOTE: for use in rooms with more than one exit.	F91	
70 CLASSROOM	Deadlocking latch bolt operated by lever from either side, except when outside lever is locked by key. Inside lever is always free to allow exit.	F84	
72 COMMUNICATING	Deadlocking latch bolt operated by lever on either side. Levers are always rigid when locked. Key in either lever locks or unlocks its own lever independently. NOTE: For use in rooms with more than one exit.	F80	
75 CLASSROOM SECURITY	Deadlocking latch bolt operated by lever from either side. Key in either lever locks or unlocks outside lever. Inside lever is always free to allow exit.	F110	
79 INSTITUTION EXIT	Deadlocking latch bolt operated by inside lever. Locked or unlocked by key from inside lever. Blank plate outside.	—	
80 STOREROOM	Deadlocking latch bolt operated by inside lever or key in outside lever. Outside lever always rigid.	F86	
82 INSTITUTION or UTILITY	Deadlocking latch bolt operated by key in either side. Both levers always rigid.	F87	
94 HOTEL or MOTEL	Deadlocking latch bolt operated by inside lever or key in outside lever. Inside push-button prevents use except by emergency key and projects visual occupancy indicator outside. Push-button released by closing door or turning inside knob. Outside lever always rigid.	F93	

DOOR LOCKS GENERAL DEADBOLT FUNCTION GUIDE

FUNCTION	DESCRIPTION	INSIDE / OUTSIDE
42 PRIVACY	Deadbolt operated by outside emergency key (or tool) or inside thumb turn at all times.	
51 SINGLE CYLINDER	Deadbolt operated by outside key or inside thumb turn at all times.	
55 ONE SIDED or THUMBTURN ONLY	Deadbolt operated by inside thumb turn only at all times.	
57 ONE SIDED, EXTERIOR PLATE or THUMBTURN ONLY, EXTERIOR PLATE	Deadbolt operated by inside thumb turn only at all times. Blank plate on outside.	
60 DOUBLE CYLINDER	Deadbolt operated by key in either cylinder at all times. NOTE: for use in rooms with more than one exit.	
70 SINGLE CYLINDER, CLASSROOM	Deadbolt engaged by outside key only. Inside thumbturn is always free to allow exit.	

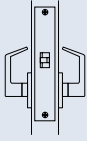
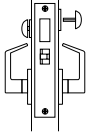
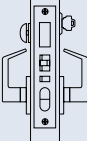
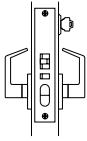
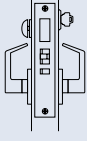
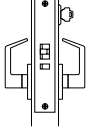
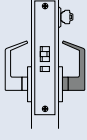
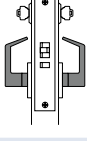
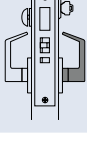

DOOR LOCKS MORTISE LOCKSET FUNCTION GUIDE

FUNCTION	DESCRIPTION	INSIDE / OUTSIDE
10 PASSAGE	Latch bolt operated by lever from either side at all times.	
42 PRIVACY	Latch bolt operated by lever from either side except when thumb turn projects dead bolt and locks outside lever. Unlock by turning inside lever or by using outside emergency key, which retracts the deadbolt.	
45 ENTRANCE	Latch bolt operated by lever from either side except when outside lever is locked by push button rocker. Deadbolt projected by outside key and by thumb turn from inside. Deadbolt retracted by outside key. Rotating inside lever retracts both bolts (simultaneous retraction). Auxiliary latch deadlocks latch bolt.	
50 OFFICE	Latch bolt operated by lever from either side except when outside lever is locked by push button rocker or outside key. Latch bolt may be retracted by outside key or inside lever. Auxiliary latch deadlocks latch bolt.	
56 DORMITORY	Latch bolt operated by lever from either side or outside key. Deadbolt projected/retracted by key from outside and thumb turn from inside. Rotating inside lever retracts both bolts simultaneously. Extended deadbolt automatically deadlocks latch bolt.	
70 CLASSROOM	Latch bolt activated by lever from either side, except when outside lever is locked by outside key. Inside lever is always free to allow exit. Auxiliary latch deadlocks latch bolt.	
80 STOREROOM	Latch bolt operated by outside key or by inside lever. Outside lever is always locked. Auxiliary latch deadlocks latch bolt.	
82 INSTITUTION or UTILITY	Latch bolt retracted by key from either side. Lever on both sides always inoperative. Auxiliary latch deadlocks latch bolt.	
84 STOREROOM WITH DEADBOLT	Deadbolt projected and retracted by outside key or by inside lever or thumb turn. Inside lever retracts both bolts simultaneously. Extended deadbolt automatically deadlocks latch bolt.	
171 SINGLE DUMMY	Fixed, through-bolt mounted, inside or outside, single lever. *Surface mount available.	
172 BACK-TO-BACK DUMMY	Fixed, through-bolt mounted, inside and outside, paired levers.	



F1H



F1C



F1S

- Type** • Cylindrical lock
- Certifications**
 - Certified ANSI/BHMA A156.2, Series 4000, Grade 1
 - cULus listed, 3hr fire-rating
 - UL 10C Positive Pressure Rating
 - Meets ADA requirements
 - 10 Year limited warranty
- Door Thickness** • 1³/₈–2¹/₄" (35–57 mm)
- Handing** • Non handed
- Backset**
 - 2³/₄" (70 mm)
 - 2³/₈" (60 mm) – available
- Spring Latch**
 - Stainless steel, 1/2" (12.7 mm) throw
 - Deadlatch, 3/4" (19 mm) throw – available
- Faceplate**
 - Mortise type, square corners
 - 1¹/₈x2¹/₄" (28.5x57 mm)
- Strike** • ASA Strike
- Trim**
 - Solid, pressure cast heavy duty lever
 - Lever secured by additional set screw
 - Brass rose
 - Rose diameter: 3¹/₂" (89 mm)

- Chassis**
 - Concealed mounting plate and screws
 - Fixed security posts
 - Lever clutch release

- Preparation**
 - Cross bore: 2¹/₈" (54 mm)
 - Edge bore: 1" (25.4 mm)

- Cylinder**
 - Solid brass, 6-pin
 - Schlage "C" keyway, 2 keys
 - Removable, rekeyable
 - Small format interchangeable core (SFIC) model – available*

Other keyways and keying options available, including CX5 high security. () BEST® and CX5® cores sold separately.*

- | | | |
|------------------|------------------|--------------|
| Functions | 10 Passage | 53 Entry |
| | 17 Dummy, single | 70 Classroom |
| | 42 Privacy | 80 Storeroom |

- Lever Styles** C–Curved return*, H–Standard return, S–Straight; no return*

() Special order.*

- Finish** 26D–Satin chrome

Other finishes available by special order.

F1	H	53	26D	238
SERIES	STYLE	FUNCTION	FINISH	OPTION ¹

(1) OPTION: 238 2-3/8IN (60MM) BACKSET

SELECTION GUIDE

SERIES	STYLE	FUNCTION ²	FINISH ²	/ CASE
F1	C ¹ , H, S ¹	10 Passage	26D	6
F1	C ¹ , H, S ¹	17 Dummy, single	26D	12
F1	C ¹ , H, S ¹	42 Privacy	26D	6
F1	C ¹ , H, S ¹	53 Entry ↔	26D	6
F1	C ¹ , H, S ¹	70 Classroom ↔	26D	6
F1	C ¹ , H, S ¹	80 Storeroom ↔	26D	6

(1) SPECIAL ORDER. (2) OTHER FINISHES AND FUNCTIONS AVAILABLE BY SPECIAL ORDER. MAY REQUIRE MINIMUM ORDER QUANTITIES AND/OR ADDITIONAL DELIVERY TIMES.

↔ KEYED FUNCTION; FULL KEYING SERVICES AVAILABLE.

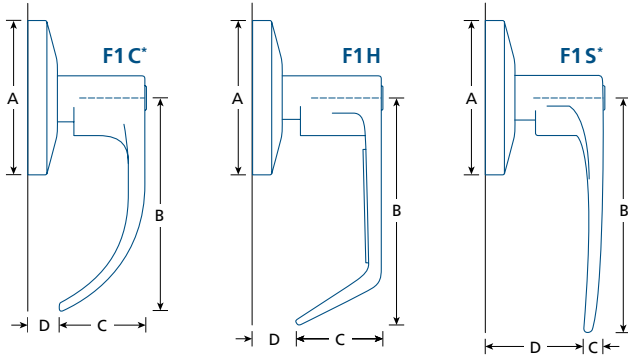

(*) SPECIAL ORDER.

		A	B	C	D*
F1C	Ⓢ	3½ (89)	4½ (114)	2½ (63.3)	5⁄8 (16)
F1H	Ⓢ	3½ (89)	5 (127)	2½ (63.3)	1½ (12.7)
F1S	Ⓢ	3½ (89)	5 (127)	¾ (19)	2¾⁄16 (56)

IN (MM) (*) DIMENSION MAY VARY DUE TO DOOR THICKNESS.

PARTS & ACCESSORIES



9106

T-Strike, square corners:
1½x2¾" (28.5x70 mm)

9106NH

T-Strike, no hole; square corners:
1½x2¾" (28.5x70 mm)



ASA-T

ASA strike with adjustable tab

ASANH

ASA strike, no hole



F1001

Passage latch: 2¾" (60 mm) backset,
1½x2¼" (28.5x57 mm) faceplate



F1010

Privacy latch: 2¾" (60 mm) backset,
1½x2¼" (28.5x57 mm) faceplate



F1DL234-34

Deadlatch: 2¾" (70 mm) backset, ¾" (19 mm)
throw. 1½x2¼" (28.5x57 mm) faceplate
For use in double door or electric strike applications





- Type** • Cylindrical lock
- Certifications**
- Certified ANSI/BHMA A156.2, Series 4000, Grade 1
 - cULus listed, 3hr fire-rating
 - UL 10C Positive Pressure Rating
 - Meets ADA requirements
 - 10 Year limited warranty
- Door Thickness**
- 1 $\frac{3}{8}$ –2" (35–51mm)
 - SFIC Models: 1 $\frac{9}{16}$ –2" (40–51mm)
- Handing** • Non handed
- Backset**
- 2 $\frac{3}{4}$ " (70 mm)
 - 2 $\frac{3}{8}$ " (60 mm) – available
 - 3 $\frac{3}{4}$ " (95 mm) – available
 - 5" (127 mm) – available
- Spring Latch**
- Stainless steel, $\frac{1}{2}$ " (12.7 mm) throw
 - Deadlatch, $\frac{3}{4}$ " (19 mm) throw – available
- Faceplate**
- Mortise type, square corners
 - 1 $\frac{1}{8}$ x2 $\frac{1}{4}$ " (28.5x57 mm)
- Strike** • ASA Strike
- Trim**
- Solid, pressure cast lever
 - Brass rose
 - Rose diameter: 3 $\frac{9}{16}$ " (90 mm)
- Chassis**
- Concealed mounting plate and screws
 - Fixed security posts
 - Lever clutch release
- Preparation**
- Cross bore: 2 $\frac{1}{8}$ " (54 mm)
 - Edge bore: 1" (25.4 mm)
- Cylinder**
- Solid brass, 6-pin
 - Schlage "C" keyway, 2 keys
 - Removable, rekeyable
 - Small format interchangeable core (SFIC) model – available*
- Other keyways and keying options available, including CX5 high security. (*) BEST® and CX5® cores sold separately.*
- Functions**
- | | | | |
|----|---------------|----|--------------------|
| 10 | Passage | 60 | Store |
| 15 | Exit | 70 | Classroom |
| 17 | Dummy, single | 75 | Classroom security |
| 42 | Privacy | 80 | Storeroom |
| 53 | Entry | 82 | Institution |
- Lever Styles** C–Curved return, L–Standard return, S–Straight; no return
- Finish** C19–Matte black, C26D–Satin chrome
- Other finishes available by special order*



GX1	L	53	C26D
SERIES	STYLE	FUNCTION	FINISH

SELECTION GUIDE

SERIES	STYLE	FUNCTION ¹	FINISH ¹	/CASE
GX1	C, L, S	10 Passage	C26D, C19 ²	6
GX1	L	15 Exit	C26D	6
GX1	L	17 Dummy, single	C26D, C19 ²	6
GX1	C, L, S	42 Privacy	C26D, C19 ²	6
GX1	C, L, S	53 Entry ↔	C26D, C19 ²	6
GX1	C, L, S	53IC Entry SFIC* ↔	C26D, C19 ²	6
GX1	L	60IC Store SFIC* ↔	C26D	6
GX1	C, L, S	70 Classroom ↔	C26D, C19 ²	6
GX1	C, L, S	70IC Classroom SFIC* ↔	C26D, C19 ²	6
GX1	L	75 Classroom security ↔	C26D	6
GX1	L	75IC Classroom security SFIC* ↔	C26D	6
GX1	C, L, S	80 Storeroom ↔	C26D, C19 ²	6
GX1	C, L, S	80IC Storeroom SFIC* ↔	C26D, C19 ²	6
GX1	L	82 Institution ↔	C26D	6

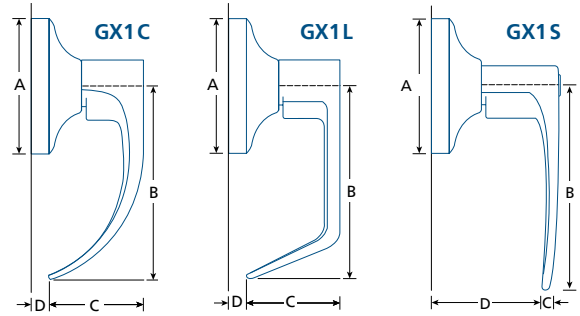
(1) OTHER FINISHES AND FUNCTIONS AVAILABLE, MINIMUM ORDER QUANTITIES AND/OR ADDITIONAL DELIVERY TIMES MAY BE REQUIRED. (2) GX1L ONLY (*) ALL SFIC MODELS ARE LESS CORE
 ↔ KEYED FUNCTION; FULL KEYING SERVICES AVAILABLE.



	A	B	C	D*
GX1C 	3 ⁹ / ₁₆ (90)	5 (127)	2 ¹ / ₂ (63.3)	3 ³ / ₈ (10)
GX1L 	3 ⁹ / ₁₆ (90)	5 (127)	2 ⁵ / ₈ (66.7)	3 ³ / ₈ (10)
GX1S 	3 ⁹ / ₁₆ (90)	5 (127)	7 ⁷ / ₈ (22)	2 ⁷ / ₁₆ (62)

IN (MM) (*) DIMENSION MAY VARY DUE TO DOOR THICKNESS.

PARTS & ACCESSORIES



9106
T-Strike, square corners:
1¹/₈x2³/₄" (28.5x70 mm)

9106NH
T-Strike, no hole; square corners:
1¹/₈x2³/₄" (28.5x70 mm)



ASA-T
ASA strike with adjustable tab

ASANH
ASA strike, no hole



CX5-9807
CX5 high security SFIC core, 7 pin, 0 bitting

CBI-BF6KD-26D
BEST® F type SFIC core, 6 pin, keyed different

CBI-BF7KD-26D
BEST® F type SFIC core, 7 pin, keyed different



GX1SL238
Passage latch: 2³/₈" (60 mm) backset,
1¹/₈x2¹/₄" (28.5x57 mm) faceplate

GX1SL234
Passage latch: 2³/₄" (70 mm) backset,
1¹/₈x2¹/₄" (28.5x57 mm) faceplate

GX1PL238
Privacy latch: 2³/₈" (60 mm) backset,
1¹/₈x2¹/₄" (28.5x57 mm) faceplate

GX1PL234
Privacy latch: 2³/₄" (70 mm) backset,
1¹/₈x2¹/₄" (28.5x57 mm) faceplate



GX1DL238
Deadlatch: 2³/₈" (60) backset,
1¹/₈x2¹/₄" (28.5x57 mm) faceplate

GX1DL234
Deadlatch: 2³/₄" (70 mm) backset,
1¹/₈x2¹/₄" (28.5x57 mm) faceplate



GX1DL234-34
Deadlatch: 2³/₄" (70 mm) backset, 3⁴/₈" (19 mm) throw,
1¹/₈x2¹/₄" (28.5x57 mm) faceplate
For use in double door or electric strike applications



GX1LE334
Backset extension to 3³/₄" (95 mm); use with
2³/₈" (60 mm) backset latch

GX1LE500
Backset extension to 5" (127 mm); use with
2³/₄" (70 mm) backset latch





- Type** • Cylindrical lock, electrified
- Certifications**
- Certified ANSI/BHMA A156.2, Series 4000, Grade 1
 - cULus listed, 3hr fire-rating
 - UL 10C Positive Pressure Rating
 - Meets ADA requirements
 - 10 Year limited mechanical warranty
 - 1 Year limited electronic warranty
- Door Thickness**
- 1 $\frac{1}{8}$ –2" (35–51mm)
 - SFIC Models: 1 $\frac{9}{16}$ –2" (40–51mm)
- Handing** • Non handed
- Backset**
- 2 $\frac{3}{4}$ " (70mm)
 - 2 $\frac{3}{8}$ " (60mm) – available
 - 3 $\frac{3}{4}$ " (95mm) – available
 - 5" (127mm) – available
- Spring Latch**
- Stainless steel, 1/2" (12.7mm) throw
 - Deadlatch, 3/4" (19mm) throw – available
- Faceplate**
- Mortise type, square corners
 - 1 $\frac{1}{8}$ x2 $\frac{1}{4}$ " (28.5x57mm)
- Strike** • ASA Strike
- Trim**
- Solid, pressure cast lever
 - Brass rose
 - Rose diameter: 3 $\frac{9}{16}$ " (90mm)

- Chassis**
- Concealed mounting plate and screws
 - Fixed security posts
 - Lever clutch release
- Preparation**
- Cross bore: 2 $\frac{1}{8}$ " (54mm)
 - Edge bore: 1" (25.4mm)
- Cylinder**
- Solid brass, 6-pin
 - Schlage "C" keyway, 2 keys
 - Removable, rekeyable
 - Small format interchangeable core (SFIC) model – available*
- Other keyways and keying options available, including CX5 high security. (*) BEST® and CX5® cores sold separately.*
- Electrical Options**
- EL Fail Safe (Power fails = Unlocked)
 - EL-RX Fail Safe, Request to Exit
 - EU Fail Secure (Power fails = Locked)
 - EU-RX Fail Secure, Request to Exit
- Power** • Dual-voltage 12–24VDC
- Current** • 12VDC – 0.6A @ 20Ω
- Draw** • 24VDC – 0.3A @ 80Ω
- Operation** • -32° to 120°F (-0° to 49°C)
- Temperature** *Temperature tolerance can vary due to weather.*
- Function** 80 Storeroom
- Lever Styles** C–Curved return, L–Standard return, S–Straight; no return
- Finish** C19–Matte black; C26D–Satin chrome
Other finishes available by special order

GX1	L	80	C26D	–	EL	–	RX
SERIES	STYLE	FUNCTION	FINISH		OPTION ¹		OPTION ²

(1) EL: FAIL SAFE (2) RX: WITH REQUEST TO EXIT

SELECTION GUIDE

SERIES	STYLE	FUNCTION ¹	FINISH ¹	/CASE
GX1	C, L, S	80 Storeroom	C19, C26D	6

(1) SFIC AND OTHER FUNCTIONS AND FINISHES AVAILABLE, MINIMUM ORDER QUANTITIES AND/OR ADDITIONAL DELIVERY TIMES MAY BE REQUIRED.
 KEYED FUNCTION; FULL KEYING SERVICES AVAILABLE.

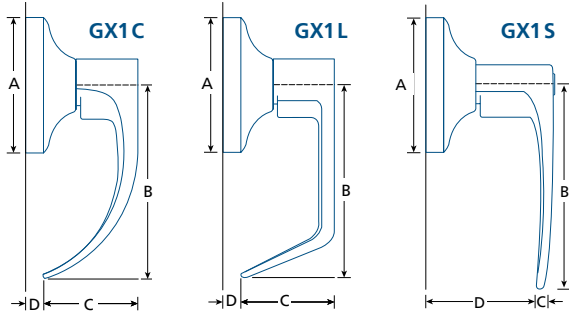

	A	B	C	D*
GX1C	3 ⁹ / ₁₆ (90)	5 (127)	2 ¹ / ₂ (63.3)	3 ³ / ₈ (10)
GX1L	3 ⁹ / ₁₆ (90)	5 (127)	2 ⁵ / ₈ (66.7)	3 ³ / ₈ (10)
GX1S	3 ⁹ / ₁₆ (90)	5 (127)	7 ⁷ / ₈ (22)	2 ⁷ / ₁₆ (62)

IN (MM) (*) DIMENSION MAY VARY DUE TO DOOR THICKNESS.

PARTS & ACCESSORIES



9106
T-Strike, square corners:
1¹/₈x2³/₄" (28.5x70 mm)

9106NH
T-Strike, no hole; square corners:
1¹/₈x2³/₄" (28.5x70 mm)



ASA-T
ASA strike with adjustable tab

ASANH
ASA strike, no hole



CX5-9807
CX5 high security SFIC core, 7 pin, 0 bitted

CBI-BF6KD-26D
BEST@ F type SFIC core, 6 pin, keyed different

CBI-BF7KD-26D
BEST@ F type SFIC core, 7 pin, keyed different



JC-603QC-BB1079-ETW04/08
Wired power transfer hinge with 4 or 8, 28 AWG wires (MAX. 24V, 4A) with molex connector. Must be installed with ball bearing hinges of the same size (4¹/₂x4). Not rated for use on fire doors. See page 04.620 for more details.



GX1SL238
Passage latch: 2³/₈" (60 mm) backset,
1¹/₈x2¹/₄" (28.5x57 mm) faceplate

GX1SL234
Passage latch: 2³/₄" (70 mm) backset,
1¹/₈x2¹/₄" (28.5x57 mm) faceplate

GX1PL238
Privacy latch: 2³/₈" (60 mm) backset,
1¹/₈x2¹/₄" (28.5x57 mm) faceplate

GX1PL234
Privacy latch: 2³/₄" (70 mm) backset,
1¹/₈x2¹/₄" (28.5x57 mm) faceplate



GX1DL238
Deadlatch: 2³/₈" (60) backset,
1¹/₈x2¹/₄" (28.5x57 mm) faceplate

GX1DL234
Deadlatch: 2³/₄" (70 mm) backset,
1¹/₈x2¹/₄" (28.5x57 mm) faceplate



GX1DL234-34
Deadlatch: 2³/₄" (70 mm) backset, 3⁴/₄" (19 mm) throw, 1¹/₈x2¹/₄" (28.5x57 mm) faceplate
For use in double door or electric strike applications



GX1LE334
Backset extension to 3³/₄" (95 mm); use with 2³/₈" (60 mm) backset latch

GX1LE500
Backset extension to 5" (127 mm); use with 2³/₄" (70 mm) backset latch





BHMA
CERTIFIED

G2

UL
LISTED

3H

ADA

10
YEAR

FC

NEW
FL

FS

- Type** • Cylindrical lock
- Certifications**
- Certified ANSI/BHMA A156.2, Series 4000, Grade 2
 - cULus listed, 3hr fire-rating
 - UL 10C Positive Pressure Rating
 - Meets ADA requirements
 - 10 Year limited warranty
- Door Thickness** • 1 $\frac{3}{8}$ – 1 $\frac{3}{4}$ " (35 – 44.5 mm)
- Handing** • Non handed
- Backset**
- 2 $\frac{3}{4}$ " (70 mm)
 - 2 $\frac{5}{8}$ " (60 mm) – available
 - 3 $\frac{3}{4}$ " (95 mm) – available
 - 5" (127 mm) – available
- Spring Latch** • Stainless steel, 1/2" (12.7 mm) throw
- Faceplate**
- Mortise type, square corners
 - 1 $\frac{1}{8}$ x 2 $\frac{1}{4}$ " (28.5 x 57 mm)
- Strike** • ASA Strike
- Trim**
- Solid, pressure cast lever
 - Brass rose
 - Rose diameter: 3 $\frac{5}{16}$ " (84.5 mm)

- Chassis**
- Concealed mounting plate and screws
 - Removable security posts
 - Lever clutch release – option*
- (* For keyed functions, may require special order)

- Preparation**
- Cross bore: 2 $\frac{1}{8}$ " (54 mm)
 - Edge bore: 1" (25.4 mm)

- Cylinder**
- Solid brass, 6-pin
 - Schlage "C" keyway, 2 keys
 - Removable, rekeyable

Other keyways and keying options available, including CX5 high security

Functions	10 Passage	53 Entry*
	15 Exit	60 Store
	17 Dummy, single	70 Classroom
	42 Privacy	80 Storeroom*
	51 Office	82 Institution

(* Lever clutch release available (-0))

- Lever Styles** C–Curved return, H–Standard return, L–Linear; no return, S–Straight; no return

- Finish** C19–Matte black, C26D–Satin chrome, C3–Polished brass

Other finishes available by special order

F	H	53	C26D	-	O
SERIES	STYLE	FUNCTION	FINISH		OPTION ¹

(1) OPTIONS: 238 2-3/8IN (60MM) BACKSET O LEVER CLUTCH RELEASE (53 & 80 ONLY)

SELECTION GUIDE

SERIES	STYLE	FUNCTION ¹	FINISH ¹	/ CASE
F	C, H, L, S	10 Passage	C26D, C3, C19 ²	12
F	C, H, S	15 Exit	C26D	12
F	C, H, L, S	17 Dummy, single	C26D, C3, C19 ²	40
F	C, H, L, S	42 Privacy	C26D, C3, C19 ²	12
F	C, H, S	51 Office ↔	C26D	12
F	C, H, L, S	53 Entry ↔	C26D, C3, C19 ²	12
F	C, H	53-O Entry, with clutch release ↔	C26D	12
F	C, H, S	60 Store ↔	C26D	12
F	C, H, L, S	70 Classroom ↔	C26D, C3, C19 ²	12
F	C, H, L, S	80 Storeroom ↔	C26D, C3, C19 ²	12
F	C, H	80-O Storeroom, with clutch release ↔	C26D	12
F	C, H, S	82 Institution / utility ↔	C26D	12

(1) OTHER FINISHES AND FUNCTIONS AVAILABLE, MINIMUM ORDER QUANTITIES AND/OR ADDITIONAL DELIVERY TIMES MAY BE REQUIRED.

↔ KEYED FUNCTION; FULL KEYING SERVICES AVAILABLE. (1) NOTE: IN-STOCK FS LEVERS ARE ONLY AVAILABLE IN C26D. (2) FH, FL ONLY.

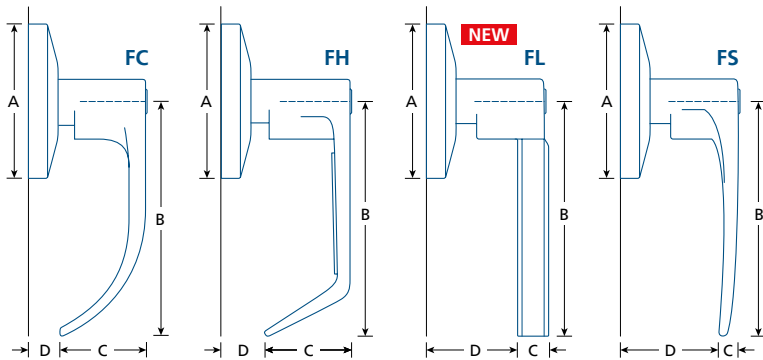

	A	B	C	D*
FC	3 5/16 (84.5)	4 1/2 (114)	1 7/8 (48)	1/2 (12.7)
FH	3 5/16 (84.5)	4 1/2 (114)	1 7/8 (48)	1/2 (12.7)
FL	3 5/16 (84.5)	4 11/16 (119)	3/4 (19)	1 27/32 (46.8)
FS	3 5/16 (84.5)	4 11/16 (119)	9/16 (14)	1 27/32 (46.8)

IN (MM) (*) DIMENSION MAY VARY DUE TO DOOR THICKNESS.

PARTS & ACCESSORIES



9106

T-Strike, square corners:
1 1/8 x 2 3/4" (28.5 x 70 mm)

9106NH

T-Strike, no hole; square corners:
1 1/8 x 2 3/4" (28.5 x 70 mm)



ASA-T

ASA strike with adjustable tab

ASANH

ASA strike, no hole



TL013

Backset extension to 3 3/4" (95 mm);
Use with 2 3/8" (60 mm) backset latch

TL014

Backset extension to 5" (127 mm);
Use with 2 3/4" (70 mm) backset latch



FH001

Passage latch: 2 3/8" (60 mm) backset,
1 1/8 x 2 1/4" (28.5 x 57 mm) faceplate

FH003

Passage latch: 2 3/4" (70 mm) backset,
1 1/8 x 2 1/4" (28.5 x 57 mm) faceplate

FH010

Privacy latch: 2 3/8" (60 mm) backset,
1 1/8 x 2 1/4" (28.5 x 57 mm) faceplate

FH002

Privacy latch: 2 3/4" (70 mm) backset,
1 1/8 x 2 1/4" (28.5 x 57 mm) faceplate



FH005

Deadlatch: 2 3/8" (60 mm) backset,
1 1/8 x 2 1/4" (28.5 x 57 mm) faceplate

FH004

Deadlatch: 2 3/4" (70 mm) backset,
1 1/8 x 2 1/4" (28.5 x 57 mm) faceplate





- Type** • Cylindrical lock
- Certifications**
 - Conforms to ANSI/BHMA A156.2, Series 4000, Grade 2
 - cULus listed, 3hr fire-rating
 - UL 10C Positive Pressure Rating
 - Meets ADA requirements
 - 10 Year limited warranty
- Door Thickness** • 1 $\frac{3}{8}$ –2" (35–51 mm)
- Handing** • Non handed
- Backset**
 - 2 $\frac{3}{4}$ " (70 mm)
 - 2 $\frac{5}{8}$ " (60 mm) – available
 - 3 $\frac{3}{4}$ " (95 mm) – available
 - 5" (127 mm) – available
- Spring Latch**
 - Stainless steel, $\frac{1}{2}$ " (12.7 mm) throw
 - Deadlatch, $\frac{3}{4}$ " (19 mm) throw – available
- Faceplate**
 - Mortise type, square corners
 - 1 $\frac{1}{8}$ x2 $\frac{1}{4}$ " (28.5x57 mm)
- Strike** • ASA Strike
- Trim**
 - Solid, pressure cast lever
 - Brass rose
 - Rose diameter: 3 $\frac{5}{16}$ " (84.5 mm)

- Chassis**
 - Concealed mounting plate and screws
 - Removable security posts
 - Lever clutch release – option*
- (*): For keyed functions, may require special order

- Preparation**
 - Cross bore: 2 $\frac{1}{8}$ " (54 mm)
 - Edge bore: 1" (25.4 mm)

- Cylinder**
 - Solid brass, 6-pin
 - Schlage "C" keyway, 2 keys
 - Removable, rekeyable
- Other keyways and keying options available, including CX5 high security

- | | | |
|------------------|------------------|--------------|
| Functions | 00 Dummy, single | 53 Entry |
| | 10 Passage | 70 Classroom |
| | 40 Privacy | 80 Storeroom |

- Lever Styles** F–The Flat; H–Standard return

- Finish** 15–Satin nickel, 19–Matte black, 26D–Satin chrome
- Other finishes available by special order

T2	F	53	–	26D	–	C
SERIES	STYLE	FUNCTION		FINISH		OPTION ¹

(1) C: CLUTCH RELEASE.

SELECTION GUIDE

SERIES	STYLE	FUNCTION ¹	FINISH ¹	/ CASE
T2	F, H	00 Dummy, single	15 ² , 19 ² , 26D	12
T2	F, H	10 Passage	15 ² , 19 ² , 26D	6
T2	F, H	40 Privacy, push button thumb-turn	15 ² , 19 ² , 26D	6
T2	F, H	53 Entry ↔	15 ² , 19 ² , 26D	6
T2	H	53-C Entry, with clutch release ↔	26D	6
T2	F, H	70 Classroom ↔	15 ² , 19 ² , 26D	6
T2	H	70-C Classroom, with clutch release ↔	26D	6
T2	F, H	80 Storeroom ↔	15 ² , 19 ² , 26D	6
T2	H	80-C Storeroom, with clutch release ↔	26D	6

(1) OTHER FINISHES AND FUNCTIONS AVAILABLE, MINIMUM ORDER QUANTITIES AND/OR ADDITIONAL DELIVERY TIMES MAY BE REQUIRED. (2) AVAILABLE FOR T2H BY SPECIAL ORDER.

↔ KEYED FUNCTION; FULL KEYING SERVICES AVAILABLE.

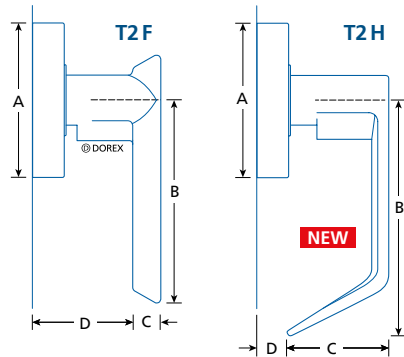

		A	B	C	D*
T2F	Ⓛ	3 5/16 (84.5)	4 7/32 (107)	5/8 (16.7)	2 (51.3)
T2H	Ⓛ	3 5/16 (84.5)	4 1/2 (114)	2 5/16 (58.7)	3/8 (9.5)

IN (MM)

(*) DIMENSION MAY VARY DUE TO DOOR THICKNESS.

PARTS & ACCESSORIES



9106

T-Strike, square corners:
1 1/8 x 2 3/4" (28.5 x 70 mm)

9106NH

T-Strike, no hole; square corners:
1 1/8 x 2 3/4" (28.5 x 70 mm)



ASA-T

ASA strike with adjustable tab

ASANH

ASA strike, no hole



TL020

Plastic spacer for latches with 1 x 2 1/4" (25.4 x 57 mm) faceplate to fit preparations for 1 1/8 x 2 1/4" (28.5 x 57 mm) faceplates



TL013

Backset extension to 3 3/4" (95 mm);
Use with 2 3/8" (60 mm) backset latch

TL014

Backset extension to 5" (127 mm);
Use with 2 3/4" (70 mm) backset latch



TL001

Passage latch: 2 3/8" (60 mm) backset,
1 x 2 1/4" (25.4 x 57 mm) faceplate

TL003

Passage latch: 2 3/4" (70 mm) backset,
1 1/8 x 2 1/4" (28.5 x 57 mm) faceplate

TL010

Privacy latch: 2 3/8" (60 mm) backset,
1 x 2 1/4" (25.4 x 57 mm) faceplate

TL002

Privacy latch: 2 3/4" (70 mm) backset,
1 1/8 x 2 1/4" (28.5 x 57 mm) faceplate

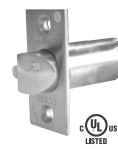

TL005

Deadlatch: 2 3/8" (60 mm) backset,
1 x 2 1/4" (25.4 x 57 mm) faceplate

TL004

Deadlatch: 2 3/4" (70 mm) backset,
1 1/8 x 2 1/4" (28.5 x 57 mm) faceplate

TL006

Deadlatch: 5" (127 mm) backset,
1 1/8 x 2 1/4" (28.5 x 57 mm) faceplate



GX1DL234-34

Deadlatch: 2 3/4" (70 mm) backset, 3/4" (19 mm) throw, 1 1/8 x 2 1/4" (28.5 x 57 mm) faceplate
For use in double door or electric strike applications





- Type** • Cylindrical lock
- Certifications**
 - Conforms to ANSHI/BHMA A156.2, Series 4000, Grade 2
 - cULus listed, 3hr fire-rating
 - UL 10C Positive Pressure Rating
 - Meets ADA requirements
 - 1 Year limited warranty
- Door Thickness**
 - 1³/₈ – 1³/₄" (35–45 mm)
 - Indicator model: 1³/₄" (45 mm)
- Handing** • Non handed
- Backset**
 - 2³/₄" (70 mm)
 - 2³/₈" (60 mm) – available*

(*) Sold separately
- Spring Latch** • Stainless steel, 1/2" (12.7 mm) throw
- Faceplate**
 - Mortise type, square corners
 - 1¹/₈ x 2¹/₄" (28.5 x 57 mm)
- Strike** • ASA Strike

- Trim**
 - Solid, pressure cast heavy duty lever
 - Brass rose
 - Rose diameter: 3³/₈" (85.7 mm)
- Chassis**
 - Concealed mounting plate and screws
 - Removable security posts
- Preparation**
 - Cross bore: 2¹/₈" (54 mm)
 - Edge bore: 1" (25.4 mm)
- Cylinder**
 - Solid brass, 6-pin
 - Schlage "C" keyway, 2 keys
 - Removable, rekeyable

Other keyways and keying options available, including CX5 high security.
- Functions**

10 Passage	53 Entry
17 Dummy, single	53I Entry w/ indicator
42 Privacy	70 Classroom
42I Privacy w/ indicator	80 Storeroom
- Lever Styles** H–Standard return
- Finish** 26D–Satin chrome

RW	H	53	-	C26D
SERIES	STYLE	FUNCTION		FINISH

(1) OPTION:

SELECTION GUIDE

SERIES	STYLE	FUNCTION ¹	FINISH	/ CASE
RW	H	10 Passage	26D	10
RW	H	17 Dummy, single	26D	20
RW	H	42 Privacy	26D	10
RW	H	42I Privacy, with indicator	26D	10
RW	H	53 Entry ↔	26D	10
RW	H	53I Entry, with indicator ↔	26D	10
RW	H	70 Classroom ↔	26D	10
RW	H	80 Storeroom ↔	26D	10

(1) OTHER FUNCTIONS AVAILABLE, MINIMUM ORDER QUANTITIES AND/OR ADDITIONAL DELIVERY TIMES MAY BE REQUIRED.
 ↔ KEYED FUNCTION; FULL KEYING SERVICES AVAILABLE.

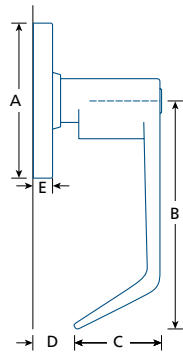

		A	B	C	D	E
RW	Ⓛ	3 ³ / ₈ (85.7)	4 ³ / ₄ (120)	2 ¹ / ₈ (54)	7 ¹ / ₁₆ * (11)	3 ³ / ₈ (9.5)
RW Indicator	Ⓛ	3 ³ / ₈ (85.7)	4 ³ / ₄ (120)	2 ¹ / ₈ (54)	7 ¹ / ₁₆ (11)	9 ¹ / ₁₆ (14.3)

IN (MM) (*) DIMENSION MAY VARY DUE TO DOOR THICKNESS.

PARTS & ACCESSORIES



9106
T-Strike, square corners:
1¹/₈x 2³/₄" (28.5x 70 mm)



ASA
ASA strike



CWAL-01
Passage latch: 2³/₈" (60 mm) backset,
1¹/₈x 2¹/₄" (28.5x 57 mm) faceplate



CWAL-05
Deadlatch: 2³/₈" (60 mm) backset,
1¹/₈x 2¹/₄" (28.5x 57 mm) faceplate





- Type** • Cylindrical lock
- Certifications**
 - Conforms to ANSHI/BHMA A156.2, Series 4000, Grade 2
 - cULus listed, 3hr fire-rating
 - UL 10C Positive Pressure Rating
 - Meets ADA requirements
 - 1 Year limited warranty
- Door Thickness** • 1 $\frac{3}{8}$ – 1 $\frac{3}{4}$ " (35–45 mm)
- Handing** • Non handed
- Backset**
 - 2 $\frac{3}{4}$ " (70 mm)
 - 2 $\frac{3}{8}$ " (60 mm) – available
- Spring Latch** • Stainless steel, 1/2" (12.7 mm) throw
- Faceplate**
 - Mortise type, square corners
 - 1 $\frac{1}{8}$ x 2 $\frac{1}{4}$ " (28.5 x 57 mm)
- Strike** • ASA Strike
- Trim**
 - Solid, pressure cast heavy duty lever
 - Brass rose
 - Rose diameter: 3" (76 mm)

- Chassis** • Concealed mounting plate and screws
- Preparation**
 - Cross bore: 2 $\frac{1}{8}$ " (54 mm)
 - Edge bore: 1" (25.4 mm)
- Cylinder**
 - Solid brass, 6-pin
 - Schlage "C" keyway, 2 keys
 - Removable, rekeyable

Other keyways and keying options available, including CX5 high security.
- Functions**

10 Passage	53 Entry
17 Dummy, single	70 Classroom
42 Privacy	80 Storeroom
- Lever Styles** H–Standard return
- Finish** 26D–Satin chrome

CW	H	53	-	C26D	238
SERIES	STYLE	FUNCTION		FINISH	OPTION ¹

(1) OPTION: 238 2-3/8IN (60MM) BACKSET

SELECTION GUIDE

SERIES	STYLE	FUNCTION ¹	FINISH	/ CASE
CW	H	10 Passage	26D	10
CW	H	17 Dummy, single	26D	20
CW	H	42 Privacy	26D	10
CW	H	53 Entry 	26D	10
CW	H	70 Classroom 	26D	10
CW	H	80 Storeroom 	26D	10

(1) OTHER FUNCTIONS AVAILABLE, MINIMUM ORDER QUANTITIES AND/OR ADDITIONAL DELIVERY TIMES MAY BE REQUIRED.

 KEYED FUNCTION; FULL KEYING SERVICES AVAILABLE.

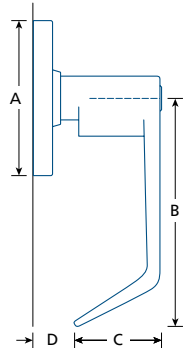

	A	B	C	D*
CWH 	3 (76)	4 ³ / ₄ (120)	2 ¹ / ₁₆ (52)	1/2 (12.7)

IN (MM)

(* DIMENSION MAY VARY DUE TO DOOR THICKNESS.

PARTS & ACCESSORIES



9106
T-Strike, square corners:
1¹/₈x 2³/₄" (28.5x 70 mm)



ASA
ASA strike



CWAL-01
Passage latch: 2³/₈" (60 mm) backset,
1¹/₈x 2¹/₄" (28.5x 57 mm) faceplate



CWAL-05
Deadlatch: 2³/₈" (60 mm) backset,
1¹/₈x 2¹/₄" (28.5x 57 mm) faceplate





- Type** • Cylindrical lock
- Certifications**
 - Conforms to ANSI/BHMA A156.2, Series 4000, Grade 2
 - cULus listed, 3hr fire-rating
 - UL 10C Positive Pressure Rating
 - Meets ADA requirements
 - 1 Year limited warranty
- Door Thickness** • 1³/₈ – 1³/₄" (35–44.5 mm)
- Handing** • Non handed
- Backset**
 - 2³/₄" (70 mm)
 - 2³/₈" (60 mm) – available
 - 3³/₄" (95 mm) – available
 - 5" (127 mm) – available
- Spring Latch** • Stainless steel, 1/2" (12.7 mm) throw
- Faceplate**
 - Mortise type, square corners
 - 1¹/₈ x 2¹/₄" (28.5 x 57 mm)
 - 2³/₈" (60 mm) backset: 1 x 2¹/₄" (25.4 x 57 mm)
- Strike** • ASA Strike
- Trim**
 - Solid, pressure cast lever
 - Brass rose
 - Rose diameter: 3" (76 mm)

- Chassis**
 - Concealed mounting plate and screws
 - Removable security posts
- Preparation**
 - Cross bore: 2¹/₈" (54 mm)
 - Edge bore: 1" (25.4 mm)
- Cylinder**
 - Solid brass, 6-pin
 - Schlage "C" keyway, 2 keys
 - Removable, rekeyable

Other keyways and keying options available, including CX5 high security
- Functions**

10 Passage	60 Store
15 Exit	70 Classroom
17 Dummy, single	79 Institution exit
42 Privacy	80 Storeroom
52 Entry ¹	82 Institution
53 Entry	

(1) See selection guide for details

Lever Styles M–Standard, return

Finish C15–Satin nickel
C3–Polished brass

Other finishes available by special order

E	M	53	C15	238
SERIES	STYLE	FUNCTION	FINISH	OPTION ¹

(1) OPTIONS: 238 2-3/8IN (60MM) BACKSET

SELECTION GUIDE

SERIES	FUNCTION ¹	FINISH ¹	/ CASE
EM	10 Passage	C15, C3	10
EM	15 Exit	C15	10
EM	17 Dummy, single	C15, C3	20
EM	42 Privacy	C15, C3	10
EM	52 Entry, locking slotted push button ↔	C15, C3	10
EM	53 Entry, locking thumb-turn push button ↔	C15, C3	10
EM	53LC Entry, less core ↔	C15, C3	10
EM	60 Store ↔	C15	10
EM	70 Classroom ↔	C15, C3	10
EM	79 Institution exit ↔	C15	10
EM	80 Storeroom ↔	C15, C3	10
EM	82 Institution ↔	C15	10

(1) OTHER FINISHES AND FUNCTIONS AVAILABLE, MINIMUM ORDER QUANTITIES AND/OR ADDITIONAL DELIVERY TIMES MAY BE REQUIRED

↔ KEYED FUNCTION; FULL KEYING SERVICES AVAILABLE

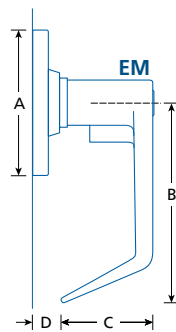

	A	B	C	D*
EM	3 (76)	4 (102)	17/8 (48)	7/16 (11)

IN (MM) (*) DIMENSION MAY VARY DUE TO DOOR THICKNESS.

PARTS & ACCESSORIES



9106
T-Strike, square corners:
1 1/8 x 2 3/4" (28.5 x 70 mm)



9106NH
T-Strike, no hole; square corners:
1 1/8 x 2 3/4" (28.5 x 70 mm)

ASA-T
ASA Strike, adjustable tab; square corners

ASANH
ASA T-Strike, no hole; square corners



TL020
Plastic spacer for latches with 1 x 2 1/4" (25.4 x 57 mm) faceplate to fit preparations for 1 1/8 x 2 1/4" (28.5 x 57 mm) faceplates



TL013
Backset extension to 3 3/4" (95 mm);
Use with 2 3/8" (60 mm) backset latch

TL014
Backset extension to 5" (127 mm);
Use with 2 3/4" (70 mm) backset latch



TL001
Passage latch: 2 3/8" (60 mm) backset,
1 x 2 1/4" (25.4 x 57 mm) faceplate

TL003
Passage latch: 2 3/4" (70 mm) backset,
1 1/8 x 2 1/4" (28.5 x 57 mm) faceplate

TL010
Privacy latch: 2 3/8" (60 mm) backset,
1 x 2 1/4" (25.4 x 57 mm) faceplate

TL002
Privacy latch: 2 3/4" (70 mm) backset,
1 1/8 x 2 1/4" (28.5 x 57 mm) faceplate



TL005
Deadlatch 2 3/8" (60 mm) backset
1 x 2 1/4" (25.4 x 57 mm) faceplate

TL004
Deadlatch: 2 3/4" (70 mm) backset,
1 1/8 x 2 1/4" (28.5 x 57 mm) faceplate

TL006
Deadlatch: 5" (127 mm) backset,
1 1/8 x 2 1/4" (28.5 x 57 mm) faceplate





- Type** • Cylindrical lock
- Certifications**
 - Certified ANSI/BHMA A156.2, Series 4000, Grade 1
 - cULus listed, 3hr fire-rating
 - UL 10C Positive Pressure Rating
 - 10 Year limited warranty
- Door Thickness**
 - 1 $\frac{3}{8}$ –2" (35–51 mm)
 - SFIC models: 1 $\frac{9}{16}$ –2" (40–51 mm)
- Handing** • Non handed
- Backset**
 - 2 $\frac{3}{4}$ " (70 mm)
 - 2 $\frac{5}{8}$ " (60 mm) – available
 - 3 $\frac{3}{4}$ " (95 mm) – available
 - 5" (127 mm) – available
- Spring Latch**
 - Stainless steel, $\frac{1}{2}$ " (12.7 mm) throw
 - Deadlatch, $\frac{3}{4}$ " (19 mm) throw – available
- Faceplate**
 - Mortise type, square corners
 - 1 $\frac{1}{8}$ x2 $\frac{1}{4}$ " (28.5x57 mm)
- Strike** • ASA Strike
- Trim**
 - Stainless steel knob
 - Stainless steel rose
 - Rose diameter: 2 $\frac{15}{16}$ " (74.6 mm)

- Chassis**
 - Concealed mounting plate and screws
 - Removable security posts
- Preparation**
 - Cross bore: 2 $\frac{1}{8}$ " (54 mm)
 - Edge bore: 1" (25.4 mm)
- Cylinder**
 - Solid brass, 6-pin
 - Schlage "C" keyway, 2 keys
 - Removable, rekeyable
 - Small format interchangeable core (SFIC) model – available*

Other keyways and keying options available, including CX5 high security. () BEST® and CX5® cores sold separately.*

Functions	10 Passage	70 Classroom
	42 Privacy	80 Storeroom
	53 Entry	
	60 Store	

Finish C32D–Stainless steel

Other finishes available by special order

GX1B	53	C32D
SERIES	FUNCTION	FINISH

SELECTION GUIDE

SERIES	FUNCTION ¹	FINISH ¹	/CASE
GX1B	10 Passage	C32D	6
GX1B	42 Privacy	C32D	6
GX1B	53 Entry ↔	C32D	6
GX1B	53IC Entry SFIC, less core ↔	C32D	6
GX1B	60 Store ↔	C32D	6
GX1B	60IC Store SFIC, less core ↔	C32D	6
GX1B	70 Classroom ↔	C32D	6
GX1B	70IC Classroom SFIC, less core ↔	C32D	6
GX1B	80 Storeroom ↔	C32D	6
GX1B	80IC Storeroom SFIC, less core ↔	C32D	6

(1) OTHER FINISHES AND FUNCTIONS AVAILABLE, MINIMUM ORDER QUANTITIES AND/OR ADDITIONAL DELIVERY TIMES MAY BE REQUIRED
 ↔ KEYED FUNCTION; FULL KEYING SERVICES AVAILABLE

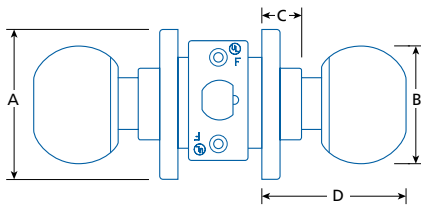

	A	B	C	D*
GX1B 	2 ¹⁵ / ₁₆ (74.6)	2 ¹ / ₄ (57)	1 ³ / ₁₆ (21)	2 ⁵ / ₈ -3 (67-76)
IN (MM)	(*) DIMENSION MAY VARY DUE TO DOOR THICKNESS.			

PARTS & ACCESSORIES



9106
T-Strike, square corners:
1¹/₈x2³/₄" (28.5x70 mm)



9106NH
T-Strike, no hole; square corners:
1¹/₈x2³/₄" (28.5x70 mm)



9807
CX5 high security SFIC core, 7 pin, 0 bitted

CX5-TPICB
GX1B tailpiece for use with CX5 SFIC cores

CBI-BF6KD-26D
BEST® F type SFIC core, 6 pin, keyed different

CBI-BF7KD-26D
BEST® F type SFIC core, 7 pin, keyed different

TPICB
Knob tailpiece for use with CX5 SFIC cores



GX1SL238
Passage latch: 2³/₈" (60 mm) backset
1¹/₈x2¹/₄" (28.5x57 mm) faceplate



GX1SL234
Passage latch: 2³/₄" (70 mm) backset
1¹/₈x2¹/₄" (28.5x57 mm) faceplate

GX1PL238
Privacy latch: 2³/₈" (60 mm) backset
1¹/₈x2¹/₄" (28.5x57 mm) faceplate

GX1PL234
Privacy latch: 2³/₄" (70 mm) backset
1¹/₈x2¹/₄" (28.5x57 mm) faceplate

GX1DL238
Deadlatch: 2³/₈" (60) backset
1¹/₈x2¹/₄" (28.5x57 mm) faceplate

GX1DL234
Deadlatch: 2³/₄" (70 mm) backset
1¹/₈x2¹/₄" (28.5x57 mm) faceplate



GX1DL234-34
Deadlatch: 2³/₄" (70 mm) backset, ³/₄" (19 mm) throw, 1¹/₈x2¹/₄" (28.5x57 mm) faceplate
For use in double door or electric strike applications



GX1LE334
Backset extension to 3³/₄" (95 mm); use with 2³/₈" (60 mm) backset latch

GX1LE500
Backset extension to 5" (127 mm); use with 2³/₄" (70 mm) backset latch





- Type** • Cylindrical lock
 - Certifications**
 - Conforms to ANSI/BHMA A156.2, Series 4000, Grade 2
 - cULus listed, 3hr fire-rating
 - UL 10C Positive Pressure Rating
 - 5 Year limited warranty
 - Door Thickness** • 1³/₈–1³/₄" (35–44.5 mm)
 - Handing** • Non handed
 - Backset**
 - 2³/₄" (70 mm)
 - 2³/₈" (60 mm) – available
 - 3³/₄" (95 mm) – available
 - 5" (127 mm) – available
 - Spring Latch** • Stainless steel, 1/2" (12.7 mm) throw
 - Faceplate**
 - Mortise type, square corners
 - 1¹/₈x2¹/₄" (28.5x57 mm)
 - 2³/₈" (60 mm) backset: 1x2¹/₄" (25.4x57mm)
 - Strike** • ASA Strike
 - Trim**
 - Brass or stainless steel knob*
 - Brass or stainless steel rose*
 - Rose diameter: 3" (76 mm)
- (*) Material dependant on finish.

- Chassis** • Concealed mounting plate and screws
 - Preparation**
 - Cross bore: 2¹/₈" (54 mm)
 - Edge bore: 1" (25.4 mm)
 - Cylinder**
 - Solid brass, 6-pin
 - Schlage "C" keyway, 2 keys
 - Removable, rekeyable

Other keyways and keying options available, including CX5 high security
 - Functions**

10 Passage	60 Store
15 Exit	70 Classroom
17 Dummy, single	79 Institution exit
32 Patio	80 Storeroom*
42 Privacy	82 Institution/utility
53 Entry*	

(*) Available without core cylinder (LC)
 - Finish** C3–Polished brass, C32D–Stainless steel
- Other finishes available by special order*

TL	53	B	C32D	238
SERIES	FUNCTION	STYLE	FINISH	OPTION ¹

(1) OPTION: 238 2-3/8IN (60MM) BACKSET LC–LESS CORE (53 & 80)

SELECTION GUIDE

SERIES	FUNCTION ¹	STYLE	FINISH ¹	/ CASE
TL	10 Passage	B	C3, C32D	20
TL	15 Exit	B	C3, C32D	20
TL	17 Dummy, single	B	C3, C32D	40
TL	32 Patio (includes full-lip D-Strike)	B	C32D	20
TL	42 Privacy	B	C3, C32D	20
TL	53 Entry ↔	B	C3, C32D	20
TL	53 LC Entry, housing only (less core) ↔	B	C32D	20
TL	60 Store ↔	B	C32D	20
TL	70 Classroom ↔	B	C3, C32D	20
TL	79 Institution / exit ↔	B	C32D	20
TL	80 Storeroom ↔	B	C3, C32D	20
TL	80 LC Storeroom, housing only (less core) ↔	B	C32D	20
TL	82 Institution / utility ↔	B	C32D	20

(1) OTHER FINISHES AND FUNCTIONS AVAILABLE, MINIMUM ORDER QUANTITIES AND/OR ADDITIONAL DELIVERY TIMES MAY BE REQUIRED
 ↔ KEYED FUNCTION; FULL KEYING SERVICES AVAILABLE

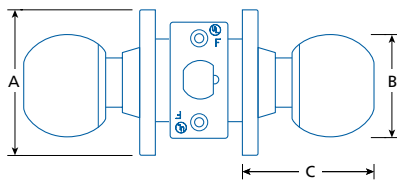

	A	B	C
TL B	3 (76)	2 1/8 (57)	2 5/8 (67)

IN (MM)

PARTS & ACCESSORIES



9102
Full lip D-Strike, adjustable tab; square corners:
1 3/4 x 2 1/4" (44.5 x 57 mm)



9106
T-Strike, square corners:
1 1/8 x 2 3/4" (28.5 x 70 mm)



9106NH
T-Strike, no hole; square corners:
1 1/8 x 2 3/4" (28.5 x 70 mm)



ASA-T
ASA strike, adjustable tab; square corners



ASANH
ASA strike, no hole; square corners



TL020
Plastic spacer for latches with 1 x 2 1/4" (25.4 x 57 mm) faceplate to fit preparations for 1 1/8 x 2 1/4" (28.5 x 57 mm) faceplates



TL013
Backset extension to 3 3/4" (95 mm);
Use with 2 3/8" (60 mm) backset latch



TL014
Backset extension to 5" (127 mm);
Use with 2 3/4" (70 mm) backset latch Use with 2 3/4" (70 mm) backset latch



TL001
Passage latch: 2 3/8" (60 mm) backset,
1 x 2 1/4" (25.4 x 57 mm) faceplate



TL003
Passage latch: 2 3/4" (70 mm) backset,
1 1/8 x 2 1/4" (28.5 x 57 mm) faceplate



TL010
Privacy latch: 2 3/8" (60 mm) backset,
1 x 2 1/4" (25.4 x 57 mm) faceplate



TL002
Privacy latch: 2 3/4" (70 mm) backset,
1 1/8 x 2 1/4" (28.5 x 57 mm) faceplate

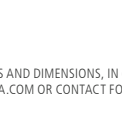

TL005
Deadlatch 2 3/8" (60 mm) backset
1 x 2 1/4" (25.4 x 57 mm) faceplate



TL004
Deadlatch: 2 3/4" (70 mm) backset,
1 1/8 x 2 1/4" (28.5 x 57 mm) faceplate

TL006
Deadlatch: 5" (127 mm) backset,
1 1/8 x 2 1/4" (28.5 x 57 mm) faceplate

TL011 (for function 32 or 94)
Deadlatch: 2 3/8" (60 mm) backset,
1 x 2 1/4" (25.4 x 57 mm) faceplate

TL012 (for function 32 or 94)
Deadlatch: 2 3/4" (70 mm) backset,
1 1/8 x 2 1/4" (28.5 x 57 mm) faceplate





- Type** • Cylindrical lock
 - Certifications**
 - Conforms to ANSI/BHMA A156.2, Series 4000, Grade 2
 - cULus listed, 3hr fire-rating
 - UL 10C Positive Pressure Rating
 - 10 Year limited warranty
 - Door Thickness** • 1³/₈–2¹/₄" (35–57 mm)
 - Handing** • Non handed
 - Backset**
 - 2³/₄" (70 mm)
 - 2³/₈" (60 mm) – available
 - 3³/₄" (95 mm) – available
 - 5" (127 mm) – available
 - Spring Latch** • Stainless steel, 1/2" (12.7 mm) throw
 - Faceplate**
 - Mortise type, square corners
 - 1¹/₈x2¹/₄" (28.5x57 mm)
 - 2³/₈" (60 mm) backset : 1 x 2¹/₄" (25.4x57mm)
 - Strike** • ASA Strike
 - Trim**
 - Brass or stainless steel knob*
 - Brass or stainless steel rose*
 - Rose diameter: 3" (76 mm)
- (*) Material dependant on finish.

- Chassis** • Concealed mounting plate and screws
 - Preparation**
 - Cross bore: 2¹/₈" (54 mm)
 - Edge bore: 1" (25.4 mm)
 - Cylinder**
 - Solid brass, 6-pin
 - Schlage "C" keyway, 2 keys
 - Removable, rekeyable

Other keyways and keying options available.
 - Functions**

00 Dummy, single	70 Classroom*
10 Passage	80 Storeroom*
40 Privacy	89 Exit
53 Entry*	

(*) Available without core cylinder (LC)
 - Finish** C3–Polished brass, C32D–Stainless steel
- Other finishes available by special order*

T2B	53	C32D	238
SERIES	FUNCTION	FINISH	OPTION ¹

(1) OPTION: 238 2-3/8IN (60MM) BACKSET LC-LESS CORE (53 & 80)

SELECTION GUIDE

SERIES	FUNCTION ¹	FINISH ¹	/ CASE
T2B	00 Dummy, single	C3, C32D	100
T2B	10 Passage	C3, C32D	20
T2B	40 Privacy	C3, C32D	20
T2B	53 Entry ↻	C3, C32D	20
T2B	53 LC Entry, housing only (less core) ↻	C3, C32D	20
T2B	70 Classroom ↻	C3, C32D	20
T2B	70 LC Classroom, housing only (less core) ↻	C32D	20
T2B	80 Storeroom ↻	C3, C32D	20
T2B	80 LC Storeroom, housing only (less core) ↻	C3, C32D	20
T2B	89 Exit	C3, C32D	20

(1) OTHER FINISHES AND FUNCTIONS AVAILABLE, MINIMUM ORDER QUANTITIES AND/OR ADDITIONAL DELIVERY TIMES MAY BE REQUIRED

↻ KEYED FUNCTION; FULL KEYING SERVICES AVAILABLE

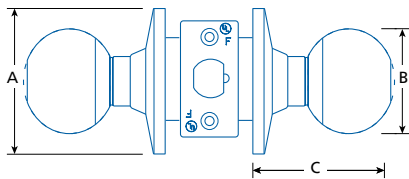

	A	B	C*
B (NON KEYED)	3 (76)	2 ¹ / ₈ (54)	2 ⁵ / ₈ -3 ¹ / ₁₆ (67-78)
B (KEYED)			2 ⁹ / ₁₆ -3 (65-76)

IN (MM) (*) DIMENSION VARIES WITH DOOR THICKNESS.

PARTS & ACCESSORIES



9102
Full lip D-Strike, adjustable tab; square corners:
1³/₄x2¹/₄" (44.5x57 mm)



9106
T-Strike, square corners:
1¹/₈x2³/₄" (28.5x70 mm)



9106NH
T-Strike, no hole; square corners:
1¹/₈x2³/₄" (28.5x70 mm)



ASA-T
ASA strike, adjustable tab; square corners



ASANH
ASA strike, no hole; square corners



TL020
Plastic spacer for latches with 1 x 2¹/₄"
(25.4x57 mm) faceplate to fit preparations
for 1¹/₈x2³/₄" (28.5x57 mm) faceplates

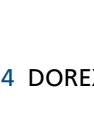

TL013
Backset extension to 3³/₄" (95 mm);
Use with 2³/₈" (60 mm) backset latch



TL014
Backset extension to 5" (127 mm);
Use with 2³/₄" (70 mm) backset latch Use with
2³/₄" (70 mm) backset latch



TL001
Passage latch: 2³/₈" (60 mm) backset,
1x2¹/₄" (25.4x57 mm) faceplate



TL003
Passage latch: 2³/₄" (70 mm) backset,
1¹/₈x2¹/₄" (28.5x57 mm) faceplate



TL010
Privacy latch: 2³/₈" (60 mm) backset,
1x2¹/₄" (25.4x57 mm) faceplate



TL002
Privacy latch: 2³/₄" (70 mm) backset,
1¹/₈x2¹/₄" (28.5x57 mm) faceplate



TL005
Deadlatch 2³/₈" (60 mm) backset
1x2¹/₄" (25.4x57 mm) faceplate

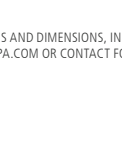

TL004
Deadlatch: 2³/₄" (70 mm) backset,
1¹/₈x2¹/₄" (28.5x57 mm) faceplate

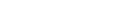

TL006
Deadlatch: 5" (127 mm) backset,
1¹/₈x2¹/₄" (28.5x57 mm) faceplate





IL80EMC15KDS shown,
Storeroom, double lock

- Type** • Interconnected cylindrical lock
- Certifications**
 - Conforms to ANSI/BHMA A156.12, Grade 2
 - cULus listed, 3 hour fire-rating
 - UL10C Positive Pressure Rating
 - Meets ADA requirements
 - 1 Year limited warranty
- Door Thickness** • 1³/₈–1³/₄" (35–44.5 mm)
- Handing** • Non handed
- Backset**
 - 2³/₄" (70 mm)
 - 2³/₈" (60 mm) – available
- Spring Latch**
 - Stainless steel
 - 1/2" (12.7 mm) throw
- Deadbolt**
 - Solid brass with hardened steel security pin
 - 1" (25.4 mm) throw
- Faceplate**
 - Mortise type, square corners
 - 1¹/₈x2¹/₄" (28.5x57 mm)
- Strikes**
 - T-Strike: 1¹/₈x2³/₄" (28.5x70 mm)
 - Deadbolt strike: 1¹/₈x2³/₄" (28.5x70 mm)
 - Plastic dust-boxes
- Interior Escutcheon**
 - Square (S): 8x3¹/₈" (203x79 mm)
 - Round (R): 8⁷/₈x3¹/₈" (225x79 mm)

- Exterior Escutcheon**
 - Square: 8x3¹/₈" (203x79 mm)
 - Round: 8⁷/₈x3¹/₈" (225x79 mm)

Not included, sold separately
- Chassis**
 - Free-spinning deadbolt cylinder collar
 - Steel deadbolt cylinder housing
 - Exposed mounting screws
 - Single action egress
- Preparation**
 - 4" (102 mm) centre-to-centre installation
 - Cross bore: 2¹/₈" (54 mm)
 - Edge bore: 1" (25.4 mm)
- Cylinder**
 - Solid brass, 6-pin
 - Schlage "C" keyway, 2 keys
 - Removable, rekeyable

Other keyways and keying options available, including CX5 high security
- Functions**
 - 10 Passage, single lock
 - 80 Storeroom, double lock
- Lever Styles** EM–Standard return

Other lever styles available by special order
- Finish** C15–Satin nickel

Other finishes available by special order

IL	10	EM	C15	KD	S	238
SERIES	FUNCTION	STYLE	FINISH	KEYING	TRIM	OPTION ¹

(1) OPTIONS: 238 2-3/8IN (60MM) BACKSET

SELECTION GUIDE

SERIES	FUNCTION	LEVER	INTERIOR TRIM	FINISH	/CASE
IL	10 Passage, single lock entry	EM	R, S	C15	10
IL	80 Storeroom, double lock entry	EM	S	C15	10

OTHER FINISHES AND FUNCTIONS AVAILABLE, MINIMUM ORDER QUANTITIES AND/OR ADDITIONAL DELIVERY TIMES MAY BE REQUIRED EXTERIOR ESCUTCHEON SOLD SEPARATELY
 KEYED FUNCTION; FULL KEYING SERVICES AVAILABLE

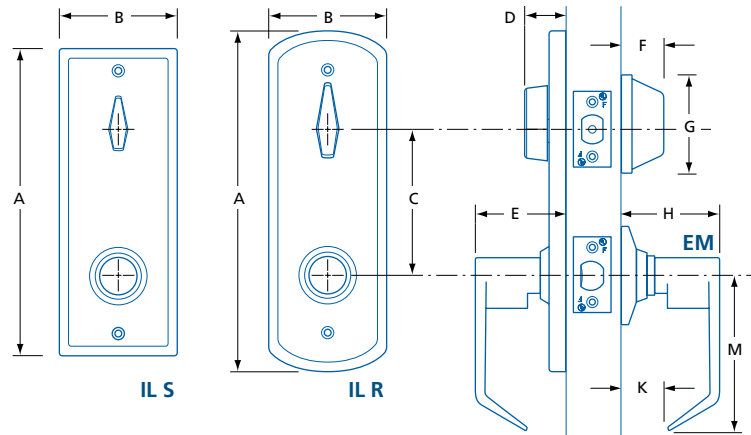

		A	B	C	D	E	F	G	H*	K*	M	P
IL R	EM	8 ⁷ / ₈ (225.4)	3 ¹ / ₈ (79)	4 (101.6)	1 ¹ / ₁₆ (27)	2 ⁹ / ₁₆ (65)	1 ¹ / ₁₆ (27.2)	2 ⁹ / ₁₆ (65)	2 ⁵ / ₁₆ (59)	3 ³ / ₈ (9.5)	4 (102)	2 ⁹ / ₁₆ (65)
IL S	EM	8 (203.2)	3 ¹ / ₈ (79)	4 (101.6)	1 ¹ / ₁₆ (27)	2 ¹ / ₈ (54)	1 ¹ / ₁₆ (27.2)	2 ⁹ / ₁₆ (65)	2 ⁵ / ₁₆ (59)	3 ³ / ₈ (9.5)	4 (102)	2 ⁹ / ₁₆ (65)

IN (MM) (*) DIMENSION MAY VARY DUE TO DOOR THICKNESS NOTE: EXTERIOR ESCUTCHEON PLATES ARE THE SAME SIZE AS THE INTERIOR ONES (SOLD SEPARATELY)

PARTS & ACCESSORIES



ILPRC15
 Exterior escutcheon, round
 8⁷/₈ x 3¹/₈ x 7¹/₁₆" (225 x 79 x 11 mm)
 Not included



ILPSC15
 Exterior escutcheon, square
 8 x 3¹/₈ x 7¹/₁₆" (203 x 79 x 11 mm)
 Not included





LS
Square rose

- Type** • Interconnected tubular lock
- Certifications**
 - Conforms to ANSI/BHMA A156.12, Grade 2
 - cULus listed, 3 hour fire-rating
 - UL10C Positive Pressure Rating
 - Lever meets ADA requirements
 - 1 Year limited warranty
- Door Thickness** • 1¾–2½" (45–55 mm)
- Handing** • Non handed
- Backset** • 2¾ – 2¾" (60–70 mm), adjustable
- Spring Latch**
 - Stainless steel
 - ½" (12.5 mm) throw
- Deadbolt**
 - Steel with hardened steel security pin
 - 1" (25.4 mm) throw
- Faceplate**
 - Mortise type, square corners
 - 1½x2¼" (28.5x57 mm)
- Strikes**
 - T-Strike: 1½x2¾" (28x70 mm)
 - Deadbolt strike: 1½x2¾" (28x70 mm)
 - Plastic dust-boxes

- Interior Escutcheon** • 8½x2¾" (216x70 mm)
- Chassis**
 - Concealed mounting screws
 - Visible lever set-screws
 - Single action egress
- Preparation**
 - 5½" (140 mm) centre-to-centre installation
 - Cross bore: 2½" (54 mm)
 - Edge bore: 1" (25.4 mm)
- Cylinder**
 - Solid brass, 6-pin
 - Schlage "C" keyway, 2 keys
- Function** 55 Suite entry, single lock, with single action egress
- Lever Styles** L–Lina, LS–Lina (square rose)
Other lever styles available by special order
- Finish** 15–Satin nickel, 19–Matte black
Other finishes available by special order

T2IL	55	L	-	15	KD	M
SERIES	FUNCTION	STYLE	FINISH	KEYING	LATCH	

SELECTION GUIDE

SERIES	FUNCTION	LEVER	FINISH	/CASE
T2 IL	55 Suite entry, single lock, with single action egress 	L, LS	15, 19	10

OTHER FINISHES AND FUNCTIONS AVAILABLE, MINIMUM ORDER QUANTITIES AND/OR ADDITIONAL DELIVERY TIMES MAY BE REQUIRED
 KEYED FUNCTION

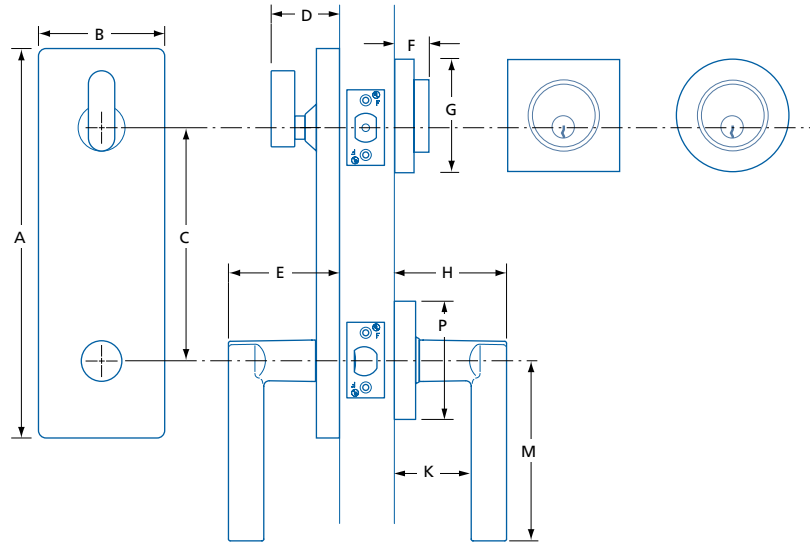

	A	B	C	D	E	F	G	H	K	M	P
T2 IL	8½ (216)	2¾ (70)	5½ (140)	1½ (38)	2½ (63.5)	¾ (19)	2½ (63.5)	2½ (63.5)	1⅝ (41.3)	4 (101.6)	2½ (63.5)

IN (MM)





- Certifications**
- Conforms to ANSI/BHMA A156.36, Grade 1
 - cULus listed, 3hr fire-rating
 - 10 Year limited warranty
- Door Thickness**
- 1 $\frac{1}{16}$ –2" (40–51 mm)
 - Kit for 2 $\frac{1}{4}$ " (57 mm) – available
- Handing**
- Non handed
- Backset**
- 2 $\frac{3}{4}$ " (70 mm)
 - 2 $\frac{3}{8}$ " (60 mm) – available
- Deadbolt**
- Solid brass with hardened steel security pin
 - 1" (25.4 mm) throw
- Faceplate**
- Mortise type, square corners
 - 1 $\frac{1}{8}$ x2 $\frac{1}{4}$ " (29x57 mm)
- Strikes**
- Wood & steel frame strikes; square corners
 - 1 $\frac{1}{8}$ x2 $\frac{3}{4}$ " (29x70 mm)
 - Plastic dust-box
- Other strikes available*
- Chassis**
- Free-spinning cylinder collar
 - Steel cylinder housing
 - Concealed mounting screws

- Preparation**
- Cross bore: 2 $\frac{1}{8}$ " (54 mm)
 - Edge bore: 1" (25.4 mm)
- Cylinder**
- Solid brass, 6-pin
 - Schlage "C" keyway, 2 keys
 - Removable, rekeyable
 - Small format interchangeable core (SFIC) model – available*
- Other keyways and keying options available, including CX5 high security. (*) BEST® and CX5® cores sold separately.*
- Functions**
- 51 Single cylinder, thumb-turn
 - 60 Double cylinder
 - 70 Single cylinder, thumb-turn (Classroom)
- Less Core (LC) available – see selection guide*
- Finish**
- C15–Satin nickel, C15A–Antique nickel, C26D–Satin chrome, C3–Polished brass, V3–Polished brass (Endurance)
- Other finishes available by special order*

GX1A	51	C26D	LC
SERIES	FUNCTION	FINISH	OPTION ⁽¹⁾

(1) OPTIONS: 238-2 3/8IN (60MM) BACKSET LC-LESS CORE (51 ONLY) WEI-WEISER KEYWAY

SELECTION GUIDE

SERIES	FUNCTION ¹	FINISH ¹	/CASE
GX1A	51 Single cylinder, thumb-turn ↔	C15, C15A, C26D, C3, C5, V3	12
GX1A	51 LC Single cylinder, thumb-turn, less core ↔	C26D	12
GX1A	51 WEI Single cylinder, thumb-turn, 5-pin Weiser keyway ↔	C26D, C3, C5	12
GX1A	51 IC Single cylinder SFIC, thumb-turn, 7-pin BEST® F core included ↔	C15, C26D	12
GX1A	60 Double cylinder ↔	C26D	12
GX1A	60IC Double cylinder SFIC, 7-pin BEST® F core included ↔	C26D	12
GX1A	70 Single cylinder, thumb-turn (Classroom) ↔	C26D	12
GX1A	70IC Single cylinder SFIC, thumb-turn, 7-pin BEST® F core included (Classroom) ↔	C26D	12

(1) OTHER FINISHES AND FUNCTIONS AVAILABLE, MINIMUM ORDER QUANTITIES AND/OR ADDITIONAL DELIVERY TIMES MAY BE REQUIRED
 ↔ KEYED FUNCTION; FULL KEYING SERVICES AVAILABLE

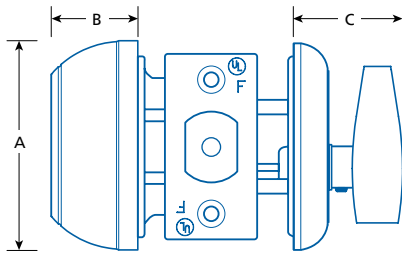

	A	B	C
GX1A	2 ¹⁵ / ₃₂ (63)	1 ¹ / ₁₆ (27)	1 ⁹ / ₃₂ (32.3)

IN (MM)

PARTS & ACCESSORIES



9111
Steel frame strike; square.
1¹/₈x2³/₄" (29x70mm)

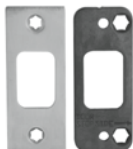

LM9111
Steel (square) and wood (round) frame security strikes.
1¹/₈x2³/₄" (29x70mm)



9118
Wood frame strike; square.
1¹/₈x2³/₄" (29x70mm)

9118R
Wood frame strike; round.
1¹/₈x2³/₄" (29x70mm)



9807
CX5 high security SFIC core, 7 pin, 0 bitted

CBI-BF6KD-26D
BEST® F type SFIC core, 6 pin, 0 bitted

CBI-BF7KD-26D
BEST® F type SFIC core, 7 pin, 0 bitted



TL007
Deadbolt: 2³/₈" (60 mm) backset,
1 x 2¹/₄" (25.4x57 mm) faceplate

TL008
Deadbolt: 2³/₄" (70 mm) backset,
1¹/₈x2¹/₄" (28.5x57 mm) faceplate



TLA85052
Longer spindle and screw kit for 2¹/₄" (57 mm) thick door. For GX1A51 or GX1A70.

TLA93110
Longer spindle and screw kit for 2¹/₄" (57 mm) thick door. For GX1A60.





FHA 421
Privacy with indicator

- Certifications**
- Conforms to ANSI/BHMA A156.36, Grade 2
 - cULus listed, 3hr fire-rating
 - 1 Year limited warranty
- Door Thickness**
- 1 $\frac{3}{8}$ –1 $\frac{3}{4}$ " (35–44.5 mm)
- Handing**
- Non handed
- Backset**
- 2 $\frac{3}{8}$ –2 $\frac{3}{4}$ " (60–70 mm) adjustable
- Deadbolt**
- Solid brass with hardened steel security pin
 - 1" (25.4 mm) throw
- Faceplate**
- Mortise type, square corners
 - 1 $\frac{1}{8}$ x2 $\frac{1}{4}$ " (29x57 mm)
- Strike**
- 2-piece security strike (wood/metal frame)
 - 1 $\frac{1}{8}$ x2 $\frac{3}{4}$ " (29x70 mm), square corners
 - Plastic dust-box
- Other strikes available*

- Chassis**
- Free-spinning cylinder collar
 - Steel cylinder housing
 - Exposed mounting screws
- Preparation**
- Cross bore: 2 $\frac{1}{8}$ " (54 mm)
 - Edge bore: 1" (25.4 mm)
- Cylinder**
- Solid brass, 6-pin
 - Schlage "C" keyway, 2 keys
 - Removable, rekeyable
- Other keyways and keying options available, including CX5 high security*
- Functions**
- 421 Privacy with indicator
 - 51 Single cylinder, thumbturn
 - 60 Double cylinder
- Finish**
- C26D–Satin chrome, C3–Polished brass, C19–Matte black
- Other finishes available by special order*

FHA	51	C26D
SERIES	FUNCTION	FINISH

SELECTION GUIDE

SERIES	FUNCTION ¹	FINISH ¹	/CASE
FHA	42I Privacy, with indicator*	C26D, C19	24
FHA	51 Single cylinder, with thumbturn ↻	C26D, C3	24
FHA	60 Double cylinder ↻	C26D, C3	24

(1) OTHER FINISHES AND FUNCTIONS AVAILABLE, MINIMUM ORDER QUANTITIES AND/OR ADDITIONAL DELIVERY TIMES MAY BE REQUIRED
 ↻ KEYED FUNCTION; FULL KEYING SERVICES AVAILABLE (*) NOT FIRE-RATED

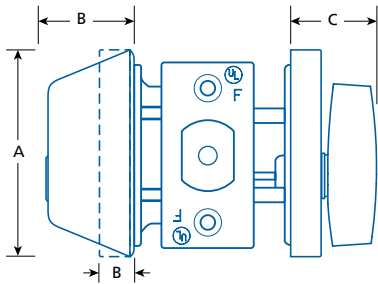

	A	B	C
FHA	2 ⁹ / ₁₆ (65)	1 (25.4)	1 (25.4)
FHA 42I	2 ¹ / ₂ (63.5)	³ / ₈ (10)	¹³ / ₁₆ (30)

IN (MM)

PARTS & ACCESSORIES



9111
Steel frame strike; square.
1¹/₈ x 2³/₄" (29 x 70 mm)

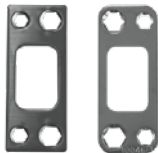

9118
Wood frame strike; square.
1¹/₈ x 2³/₄" (29 x 70 mm)

9118R
Wood frame strike; round.
1¹/₈ x 2³/₄" (29 x 70 mm)





TLA 42I
Privacy with indicator

- Certifications**
- Conforms to ANSI/BHMA A156.36, Grade 2
 - cULus listed, 3hr fire-rating*
 - 5 Year limited warranty
- (*) Except privacy model 42I

- Door Thickness**
- 1 $\frac{3}{8}$ –1 $\frac{3}{4}$ " (35–44.5 mm)
 - SFIC Model: 1 $\frac{1}{16}$ –2" (40–51 mm)
 - Kit for 2 $\frac{1}{4}$ " (57 mm) – available

- Handing**
- Non handed

- Backset**
- 2 $\frac{3}{4}$ " (70 mm)
 - 2 $\frac{5}{8}$ " (60 mm) – available
 - 2 $\frac{3}{8}$ –2 $\frac{3}{4}$ " (60–70 mm) adjustable – available

- Deadbolt**
- Solid brass with hardened steel security pin
 - 1" (25.4 mm) throw

- Faceplate**
- Mortise type, square corners
 - 1 $\frac{1}{8}$ x2 $\frac{1}{4}$ " (29x57 mm)

- Strike**
- 2-piece security strike (wood/metal frame)
 - 1 $\frac{1}{8}$ x2 $\frac{3}{4}$ " (29x70 mm), square corners
 - Plastic dust-box
- Other strikes available

- Chassis**
- Free-spinning cylinder collar
 - Steel cylinder housing
 - Exposed mounting screws

- Preparation**
- Cross bore: 1 $\frac{1}{2}$ " or 2 $\frac{1}{8}$ " (38 mm or 54 mm)*
 - Edge bore: 1" (25.4 mm)
- (*) 1 $\frac{1}{2}$ " (38 mm) installation will negate Grade 2 conformity, but will retain fire-rating.

- Cylinder**
- Solid brass, 6-pin
 - Schlage "C" keyway, 2 keys
 - Removable, rekeyable
 - Small format interchangeable core (SFIC) model – available
- Other keyways and keying options available, including CX5 high security.

- Functions**
- 42I Privacy with indicator*
 - 51 Single cylinder, thumb-turn
 - 57 Thumb-turn only, exterior plate
 - 60 Double cylinder
 - 70 Single cylinder, thumb-turn (Classroom)
- (*) Emergency unlock by emergency key or flat head screw driver. Emergency key is not included.

- Finish**
- C19–Matte black, C26D–Satin chrome, C3–Polished brass, C32D–Satin stainless steel
- Other finishes available by special order

TLA	51	C32D	-U
SERIES	FUNCTION	FINISH	OPTION ¹

(1) OPTIONS: 238–2 3/8IN (60MM) BACKSET -U–ADJUSTABLE BACKSET

SELECTION GUIDE

SERIES	FUNCTION ¹	FINISH ¹	/CASE
TLA	42I Privacy, with indicator*	26D, 32D	20
TLA	51 Single cylinder with thumb-turn ↔	C19, C26D, C3, C32D	20
TLA	51-U Single cylinder with thumb-turn, adjustable backset option ↔	C26D, C32D	20
TLA	51IC Single cylinder with thumb-turn (BEST@ F, 7-pin SFIC included) ↔	C26D, C32D	20
TLA	57 Thumb-turn only with blank exterior plate	C26D	20
TLA	60 Double cylinder ↔	C3, C32D	20
TLA	60-U Double cylinder, adjustable backset option ↔	C32D	20
TLA	70 Single cylinder, with thumb-turn (Classroom) ↔	C32D	20

(1) OTHER FINISHES AND FUNCTIONS AVAILABLE, MINIMUM ORDER QUANTITIES AND/OR ADDITIONAL DELIVERY TIMES MAY BE REQUIRED

↔ KEYED FUNCTION; FULL KEYING SERVICES AVAILABLE (*) CANNOT ACCOMMODATE DOORS THICKER THAN 1-3/4IN (44.5 MM); NOT FIRE-RATED

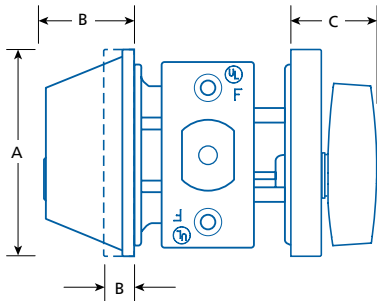

	ø A	B	C
TLA	2 9/16 (65)	1 1/8 (29)	1 (25)
TLA 42I	2 9/16 (65)	1 1/32 (8.5)	1 (25)
TLA 57	2 9/16 (65)	1 1/32 (8.5)	1 (25)

IN (MM)

PARTS & ACCESSORIES



9111
Steel frame strike; square.
1 1/8 x 2 3/4" (29 x 70 mm)



9118
Wood frame strike; square.
1 1/8 x 2 3/4" (29 x 70 mm)

9118R
Wood frame strike; round.
1 1/8 x 2 3/4" (29 x 70 mm)



9807
CX5 high security SFIC core, 7 pin, 0 bitted

CBI-BF6KD-26D
BEST@ F type SFIC core, 6 pin, keyed different

CBI-BF7KD-26D
BEST@ F type SFIC core, 7 pin, keyed different



TLA42-EKEY
Emergency key for TLA42I.



TL007
Deadbolt: 2 3/8" (60 mm) backset,
1 x 2 1/4" (25.4 x 57 mm) faceplate

TL008
Deadbolt: 2 3/4" (70 mm) backset,
1 1/8 x 2 1/4" (28.5 x 57 mm) faceplate

TLA-LBU
Deadbolt: 2 3/8-2 3/4" (60-70 mm) adjustable
backset, 1 x 2 1/4" (25.4 x 57 mm) faceplate



TL020
Plastic spacer for latches with 1 x 2 1/4"
(25.4 x 57 mm) faceplate to fit preparations
for 1 1/8 x 2 1/4" (28.5 x 57 mm) faceplates



TLA85052
Longer spindle and screw kit for 2 1/4" (57 mm)
thick door. For TLA51 or TLA70 only, cannot
be used with TLA42I Indicator model.

TLA93110
Longer spindle and screw kit for 2 1/4" (57 mm)
thick door. For TLA60.





- Certifications**
- Conforms to ANSI/BHMA A156.36, Grade 1
 - cULus listed, 3hr fire-rating
 - 5 Year limited warranty

- Door Thickness**
- 1 $\frac{3}{8}$ –2" (35–51 mm)

- Handing**
- Non handed

- Backset**
- 2 $\frac{3}{4}$ " (70 mm)
 - 2 $\frac{3}{8}$ " (60 mm) – available

- Spring Latch**
- Solid brass deadlatch
 - $\frac{5}{8}$ " (15.9mm) throw

- Faceplate**
- Mortise type, square corners
 - 1 $\frac{1}{8}$ x2 $\frac{1}{4}$ " (29x57 mm)
 - Self-adjustable for bevelled doors

- Strikes**
- T-type strike, 1 $\frac{1}{8}$ x2 $\frac{3}{4}$ " (29x70 mm)
 - Wood frame security plate with 3" (76 mm) wood screws
 - Plastic dust-box

- Chassis**
- Die-cast trim ring with protective shield
 - Free-spinning solid brass cylinder collar
 - High-strength steel cylinder housing
 - Through bolt mounted
 - Exposed mounting screws

- Preparation**
- Cross bore: 2 $\frac{1}{8}$ " (54 mm)
 - Edge bore: 1" (25.4 mm)

- Cylinder**
- Solid brass, 6-pin
 - Schlage "C" keyway, 2 keys
 - Removable, rekeyable
 - Small format interchangeable core (SFIC) model – available*

Other keyways and keying options available, including CX5 high security. () Special order.*

- Functions** 51 Single cylinder, thumb-turn

- Finish** 26D–Satin chrome

Other finishes available by special order

DG1	AN	51	–	26D
SERIES		FUNCTION		FINISH

SELECTION GUIDE

SERIES	FUNCTION ¹	FINISH ¹	/CASE
DG1	51 Single cylinder, thumb-turn	26D	12

(1) OTHER FINISHES AND FUNCTIONS AVAILABLE, MINIMUM ORDER QUANTITIES AND/OR ADDITIONAL DELIVERY TIMES MAY BE REQUIRED
 • KEYED FUNCTION; FULL KEYING SERVICES AVAILABLE

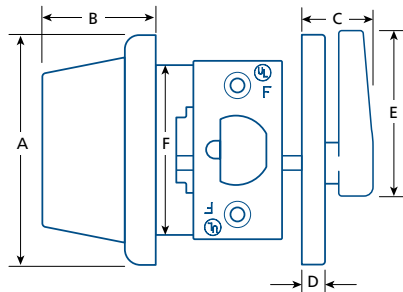

	A	B	C	D	E	F
DG1	2 ⁵ / ₈ (67)	1 ⁹ / ₃₂ (32.5)	1 ⁵ / ₁₆ (24)	9/ ₃₂ (7)	1 ³ / ₄ (44.5)	2 (51)

IN (MM)

PARTS & ACCESSORIES



DGPL238

Deadlatch: 2³/₈" (60 mm) backset,
 1¹/₈ x 2¹/₄" (28.5 x 57 mm) faceplate



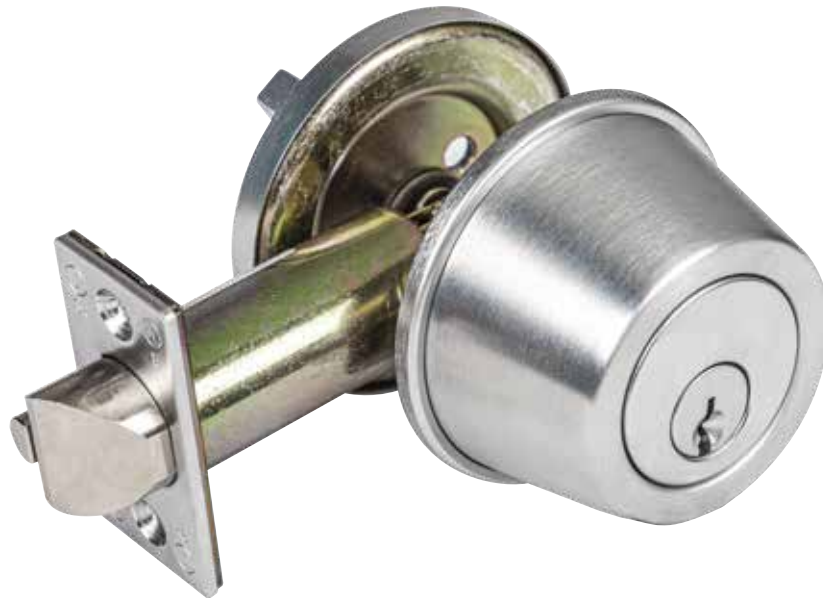

- Certifications**
- Conforms to ANSI/BHMA A156.36, Grade 2
 - cULus listed, 3hr fire-rating
 - 5 Year limited warranty

- Door Thickness**
- 1 $\frac{3}{8}$ –2" (35–51 mm)

- Handing**
- Non handed

- Backset**
- 2 $\frac{3}{4}$ " (70 mm)
 - 2 $\frac{3}{8}$ " (60 mm) – available

- Spring Latch**
- Solid brass deadlatch
 - $\frac{5}{8}$ " (15.9mm) throw

- Faceplate**
- Mortise type, square corners
 - 1 $\frac{1}{8}$ x2 $\frac{1}{4}$ " (29x57 mm)
 - Self-adjustable for bevelled doors

- Strikes**
- T-type strike, 1 $\frac{1}{8}$ x2 $\frac{3}{4}$ " (29x70 mm)
 - Wood frame security plate with 3" (76 mm) wood screws
 - Plastic dust-box

- Chassis**
- Die-cast trim ring
 - Free-spinning solid brass cylinder collar
 - High-strength steel cylinder housing
 - Through bolt mounted
 - Exposed mounting screws

- Preparation**
- Cross bore: 2 $\frac{1}{8}$ " (54 mm)
 - Edge bore: 1" (25.4 mm)

- Cylinder**
- Solid brass, 6-pin
 - Schlage "C" keyway, 2 keys
 - Removable, rekeyable
 - Small format interchangeable core (SFIC) model – available*

Other keyways and keying options available, including CX5 high security. () Special order.*

- Functions** 51 Single cylinder, thumb-turn

- Finish** 26D–Satin chrome

Other finishes available by special order

DG2	AN	51	–	26D
SERIES		FUNCTION		FINISH

SELECTION GUIDE

SERIES	FUNCTION ¹	FINISH ¹	/CASE
DG2	51 Single cylinder, thumb-turn	26D	20

(1) OTHER FINISHES AND FUNCTIONS AVAILABLE, MINIMUM ORDER QUANTITIES AND/OR ADDITIONAL DELIVERY TIMES MAY BE REQUIRED
 • KEYED FUNCTION; FULL KEYING SERVICES AVAILABLE

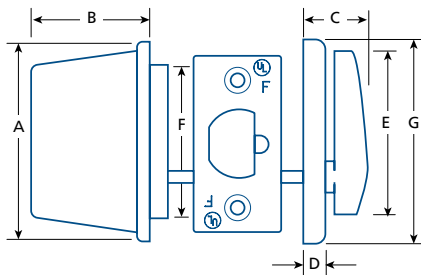

	A	B	C	D	E	F	G
DG2	2 ⁵ / ₈ (67)	1 ⁹ / ₃₂ (32.5)	1 ⁵ / ₁₆ (24)	9 ³ / ₃₂ (7)	1 ³ / ₄ (44.5)	2 (51)	2 ⁵ / ₈ (67)

IN (MM)

PARTS & ACCESSORIES



DGPL238
 Deadlatch: 2³/₈" (60 mm) backset,
 1¹/₈ x 2¹/₄" (28.5 x 57 mm) faceplate





- Certifications**
- Certified ANSI/BHMA A156.13, Series 1000, Grade 1
 - cULus listed, 3hr fire-rating
 - UL10C Positive Pressure Rated
 - Levers meet ADA (ANSI 117.1) requirements
 - 5 Year limited warranty

- Door Thickness**
- 1¾" (44.5 mm)
 - 2-2¼" (51-57 mm) – available

- Handing**
- Handed, field reversible

- Backset**
- 2¾" (70 mm)

- Spring Latch**
- Brass, anti-friction
 - ¾" (19 mm) throw
 - Auxiliary deadlocking latch

- Deadbolt**
- Solid bolt, 2 security pins
 - 1" (25.4 mm) throw

- Faceplate**
- 1¼ x 8" (32x203 mm), square corners
 - Adjusts for bevelled doors up to ⅛" (3 mm)

- Strike**
- ANSI-type strike and dust-box

- Cylinder**
- 6 pin mortise cylinder
 - Schlage "C" with 2 keys
 - Small format interchangeable core (SFIC) mortise housing available (SFIC not included)
- Other keyways and keying options available, including CX5 high security*

- Sectional Trim**
- Brass lever or knob
 - Brass rose
 - S-Round: ø 2⅞ x ½" (61.5 x 12.7 mm)
 - SQ-Square: 1⅞ x 1⅞ x ½" (48 x 48 x 12.7 mm)

- Escutcheon Trim**
- Brass lever or knob
 - Brass escutcheon
 - E-Regular 2 x 8⅞ x ½" (50 x 205 x 12.7 mm)
 - E2-Wide 2½ x 8⅞ x ½" (63 x 210 x 12.7 mm)
 - E3-Large 2¾ x 10¾ x ½" (70 x 273 x 12.7 mm)

- Chassis**
- Rose trim: concealed mounting screws
 - Thumb-turn: exposed mounting screws
 - Escutcheon: exposed mounting screws
 - Single action egress

- Functions**
- | | |
|------------------------|--------------------------|
| 10 Passage | 80 Storeroom |
| 42 Privacy | 84 Storeroom w/ deadbolt |
| 42I Privacy, indicator | 170 Dummy, surface* |
| 45 Entry | 171 Dummy, thru-bolt* |
| 50 Office | 172 Dummy, back-to-back |
| 56 Dormitory | |
| 70 Classroom | |

(* Sold in pairs.)

- Lever Styles** A-Apollo, R-Circa, C-Cornell, D-Dartmouth, G-Glasgow, L-Linea, S-Stanford, F-The Flat, T-Strata

- Knob Styles** K-Kent

- Finish** 15-Satin nickel, 19-Matte black, 26D-Satin chrome
- Other finishes available by special order*

DM	45	L	-	SQ	F	26D
SERIES	FUNCTION	HAND ¹⁾	TRIM	STYLE	FINISH	

(1) L-LEFT R-RIGHT

SELECTION GUIDE

SERIES	TRIM	STYLE**	FUNCTION ¹	FINISH ¹	/CASE
DM	S, SQ, E, E2, E3	ALL	10 Passage	15, 19, 26D	6
DM	S, SQ, E, E2, E3	ALL	42 Privacy, with deadbolt	15, 19, 26D	6
DM	E	ALL	42I Privacy indicator, with deadbolt ² ←	15, 19, 26D	6
DM	S, SQ, E, E2, E3	ALL	45 Entry, with deadbolt ←	15, 19, 26D	6
DM	S, SQ, E, E2, E3	ALL	50 Office ←	15, 19, 26D	6
DM	S, SQ, E, E2, E3	ALL	56 Dormitory, with deadbolt ←	15, 19, 26D	6
DM	S, SQ, E, E2, E3	ALL	70 Classroom ←	15, 19, 26D	6
DM	S, SQ, E, E2, E3	ALL	80* Storeroom ←	15, 19, 26D	6
DM	S, SQ, E, E2, E3	ALL	84* Storeroom, with deadbolt ←	15, 19, 26D	6
DM	S, SQ	ALL	170 Dummy, single (surface mount)	15, 19, 26D	6
DM	S, SQ	ALL	171 Dummy, single (thru-bolt)	15, 19, 26D	6
DM	S, SQ, E, E2, E3	ALL	172 Dummy, back-to-back	15, 19, 26D	6

(1) OTHER FINISHES AND FUNCTIONS AVAILABLE, MINIMUM ORDER QUANTITIES AND/OR ADDITIONAL DELIVERY TIMES MAY BE REQUIRED – PLEASE CONTACT

(2) FOR DETAILS ABOUT ESCUTCHEON WITH OCCUPANCY INDICATOR - PLEASE CONTACT

← KEYED FUNCTION; FULL KEYING SERVICES AVAILABLE – PLEASE CONTACT (*) ONE-SIDED INSTALLATION MODEL AVAILABLE (**) XT / INTERSECT NOT AVAILABLE WITH ESCUTCHEON

LEVERS & KNOBS

A–Apollo

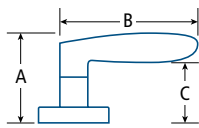

C–Cornell

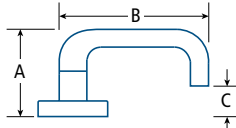

D–Dartmouth

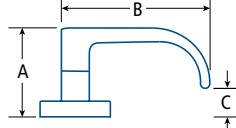

F–The Flat

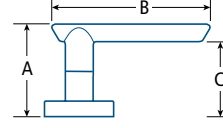

G–Glasgow

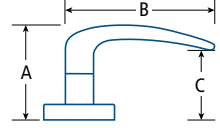

L–Linea

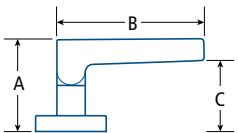

R–Circa

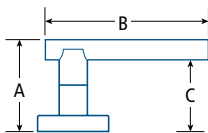

S–Stanford

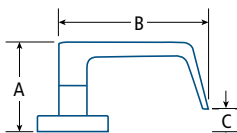

T–Strata

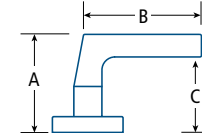

K–Kent

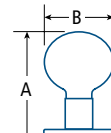

STYLE	A	B	C ¹
A–Apollo*	3 ¹ / ₁₆ (78)	4 ⁵ / ₈ (116)	2 ¹ / ₁₆ (53)
C–Cornell	2 ⁷ / ₈ (73)	5 ⁵ / ₁₆ (134)	⁵ / ₈ (16)
D–Dartmouth	2 ⁷ / ₁₆ (61.5)	5 ⁷ / ₈ (149)	1 ¹ / ₁₆ (17)
F–The Flat	2 ⁷ / ₈ (73)	5 ¹ / ₂ (139.7)	2 ³ / ₁₆ (55.5)
G–Glasgow	2 ⁷ / ₈ (73)	5 ¹ / ₁₆ (128)	2 ¹ / ₁₆ (52)

STYLE	A	B	C ¹
L–Linea	2 ¹³ / ₁₆ (71.4)	5 (127)	1 ¹⁵ / ₁₆ (48.4)
R–Circa	2 ⁹ / ₁₆ (65.5)	5 ¹ / ₂ (139.7)	1 ⁷ / ₈ (47)
S–Stanford	2 ⁹ / ₁₆ (65.5)	5 ¹ / ₁₆ (128)	⁹ / ₁₆ (14)
T–Strata	3 ¹ / ₈ (79.4)	5 ⁵ / ₈ (130.2)	2 ¹ / ₈ (54)
K–Kent	2 ⁷ / ₁₆ (61.5)	∅ 2 (50.8)	—

IN (MM) (1) ALL ROSES AND ESCUTCHEONS ARE 12.7 (1/2) THICK

(*) HANDED LEVER, NOT FIELD REVERSIBLE,
(**) SECTIONAL ONLY, NOT AVAILABLE WITH ESCUTCHEON



LOCK TRIMS

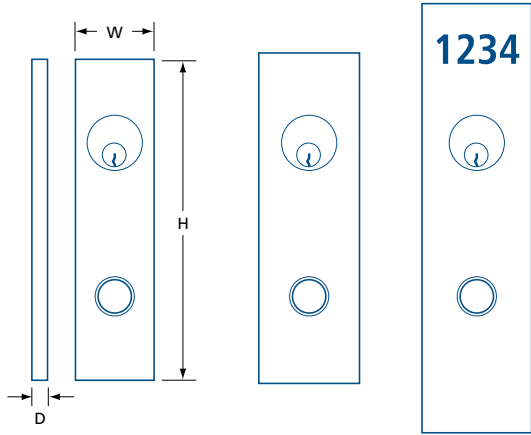

OPTIONAL ENGRAVING (SPECIAL ORDER)

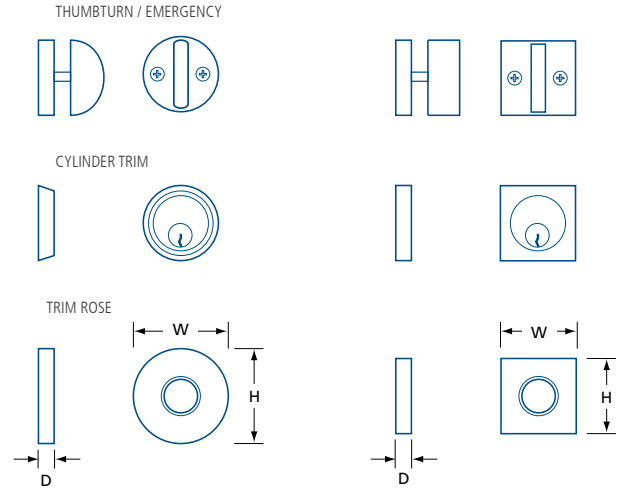

	ESCUTCHEON TRIM			SECTIONAL ROUND			SECTIONAL SQUARE		
TRIM	E	E2	E3 ¹	S			SQ		
Description	Regular escutcheon	Wide escutcheon	Large escutcheon	Round rose	Cylinder trim	Thumbturn	Square rose	Cylinder trim	Thumbturn
Width (W)	2 (50)	2 1/2 (64)	2 3/4 (70)	ø 2 3/8 (60)	1 13/16 (46)	1 3/4 (44.4)	1 7/8 (48)	1 7/8 (47.6)	1 7/8 (47.6)
Height (H)	8 1/16 (205)	8 1/4 (210)	10 3/4 (273)	—	1 13/16 (46)	1 3/4 (44.4)	1 7/8 (48)	1 7/8 (47.6)	1 7/8 (47.6)
Depth (D)	1/2 (12.7)	1/2 (12.7)	1/2 (12.7)	1/2 (12.7)	7/16 (11.1)	3/16 (4.7)	1/2 (12.7)	3/8 (9.5)	3/8 (9.5)
Material	Brass	Brass	Brass	Brass	Brass	Brass	Brass	Brass	Brass

IN (MM) (1)OPTIONAL ENGRAVING AVAILABLE—PLEASE CONTACT

DIMENSIONS

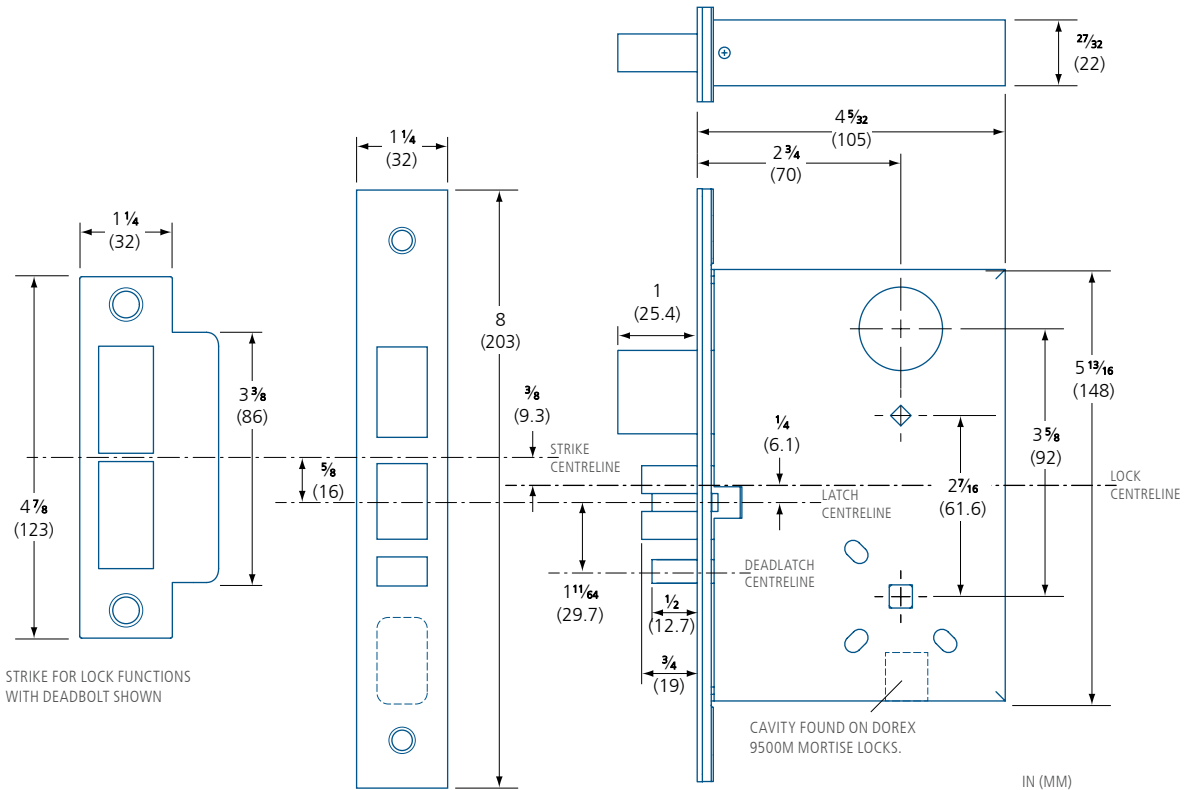

MUST BE INSTALLED ON A DOOR WITH A SOLID LOCK STILE WIDTH OF AT LEAST 5" (127 MM) OR WITH APPROPRIATE REINFORCEMENT.

⚠ WHEN USED WITH ELECTRIC STRIKE PLEASE REQUEST ADDITIONAL INFORMATION.

PARTS & ACCESSORIES



DM45X-PS
Replacement strike for 1 $\frac{3}{4}$ " (45) thick door.
(Functions 42, 45, 56, 84)



DM80X-PS
Replacement strike for 1 $\frac{3}{4}$ " (45) thick door.
(Functions 10, 50, 70, 80)



DM42X-PE
Mortise lock emergency privacy key; round.
Includes plate and screws.
Finish: 15, 19, 26D



DM42X-PES
Mortise lock emergency privacy key; square.
Includes plate and screws.
Finish: 15, 19, 26D



DM45X-PT
Mortise lock thumbturn; round. Mounting screws included.
Finish: 15, 19, 26D



DM45X-PTS
Mortise lock thumbturn; square. Mounting screws included.
Finish: 15, 19, 26D



DM00X-PPRVI
Sectional occupancy indicator. Includes round interior/exterior trims for use with privacy (42) function. For 1 $\frac{3}{4}$ " (44.5) thick wood door. Mounting hardware included. Finish: 15, 26D



DM00X-PPRVIQ
Sectional occupancy indicator. Includes square interior/exterior trims for use with privacy (42) function. For 1 $\frac{3}{4}$ " (44.5) thick wood door. Mounting hardware included. Finish: 15, 26D



DM00X-PPRVI-ECYL
Sectional keyed occupancy indicator. Includes round interior/exterior trims for use with keyed functions 45, 56, or 84. For 1 $\frac{3}{4}$ " (44.5) thick wood door. Mounting hardware and DM00X-ECYL cylinder with 2 keys included. Finish: 15, 26D



DM00X-PPRVIQ-ECYL
Sectional keyed occupancy indicator. Includes square interior/exterior trims for use with keyed functions 45, 46, or 84. For 1 $\frac{3}{4}$ " (44.5) thick wood door. Mounting hardware and DM00X-ECYL cylinder with 2 keys included. Finish: 15, 26D



DM45X-PR
Mortise cylinder collar with spring; round.
1 $\frac{1}{16}$ " x $\frac{3}{8}$ " (Ø43 x 9)
Finish: 15, 19, 26D



DM45X-PRS
Mortise cylinder collar with spring; square.
1 $\frac{7}{8}$ " x 1 $\frac{7}{8}$ " x $\frac{3}{8}$ " (48 x 48 x 9)
Finish: 15, 19, 26D



DM00X-PSCYL

- 1 $\frac{1}{8}$ " (28.6) 5-pin (drilled 6) brass mortise cylinder; Schlage "C" with 2 keys.
- For sectional installations on 1 $\frac{3}{4}$ " (45) thick doors.
- Includes DM00X-PCAM.
- Finish: 15, 19, 26D

DM00X-PECYL

- 1 $\frac{1}{4}$ " (31.8) 5-pin (drilled 6) brass mortise cylinder; Schlage "C" with 2 keys.
- For escutcheon installations on 1 $\frac{3}{4}$ " (45) thick doors.
- Includes DM00X-PCAM.
- Finish: 15, 19, 26D



DM00X-PCAM
Replacement mortise cylinder cam, with screws

NOTE: OTHER CYLINDERS MAY REQUIRE A DIFFERENT CAM. PLEASE CONTACT IF USING A DIFFERENT CYLINDER. OTHER CAMS SOLD SEPARATELY.



DM00X-PKDT225
Installation kit for 2–2 $\frac{1}{4}$ " (51–57) thick doors.

- Includes extended emergency thumbturn, spindle, springs, strike and mounting hardware for sectional or escutcheon trim.
- Mortise cylinder NOT INCLUDED.

Please contact for details.





*SHOWN WITH OPTIONAL CYLINDER & COLLARS

- Certifications**
- Conforms to ANSI/BHMA A156.36, Grade 1
 - cULus listed, 3hr fire-rating
 - 5 Year limited warranty

Door Thickness • 1¼–2" (44.5–51 mm)

Handing • Non-handed

Backset • 2¾" (70 mm)

Deadbolt • Solid bolt
• 1" (25.4 mm) throw

Faceplate • 1¼ x 5⅞" (31.5 x 142 mm)
• Square corners

Strike • 1⅞ x 3½" (28.9 x 88.9 mm)
• Square corners
• Metal dust-box included

Trim • Cylinder collar and thumbturn available
• Round or square styles available

Sold separately, please contact for details

Chassis • Function 64: concealed mounting
All other functions: exposed mounting

Cylinder • Conventional and high security mortise cylinders available
• Small format interchangeable core (SFIC) mortise housing available (less core)
Sold separately, please contact for details

Functions 51 Single cylinder with thumbturn
55 Thumbturn only
60 Double cylinder
64 Cylinder only¹

(1) For use in rooms with more than one exit

Finish¹ 15–Satin nickel; 19–Matte black;
26D–Satin chrome

*Other finishes available by special order
(1) DMDBL strike and faceplate are 26D.
Trims are available in 15, 19, or 26D.*

DMDBL
SERIES

CONFIGURED TO ORDER – PLEASE CONTACT YOUR LOCAL SALES REPRESENTATIVE FOR DETAILS.

DIMENSIONS

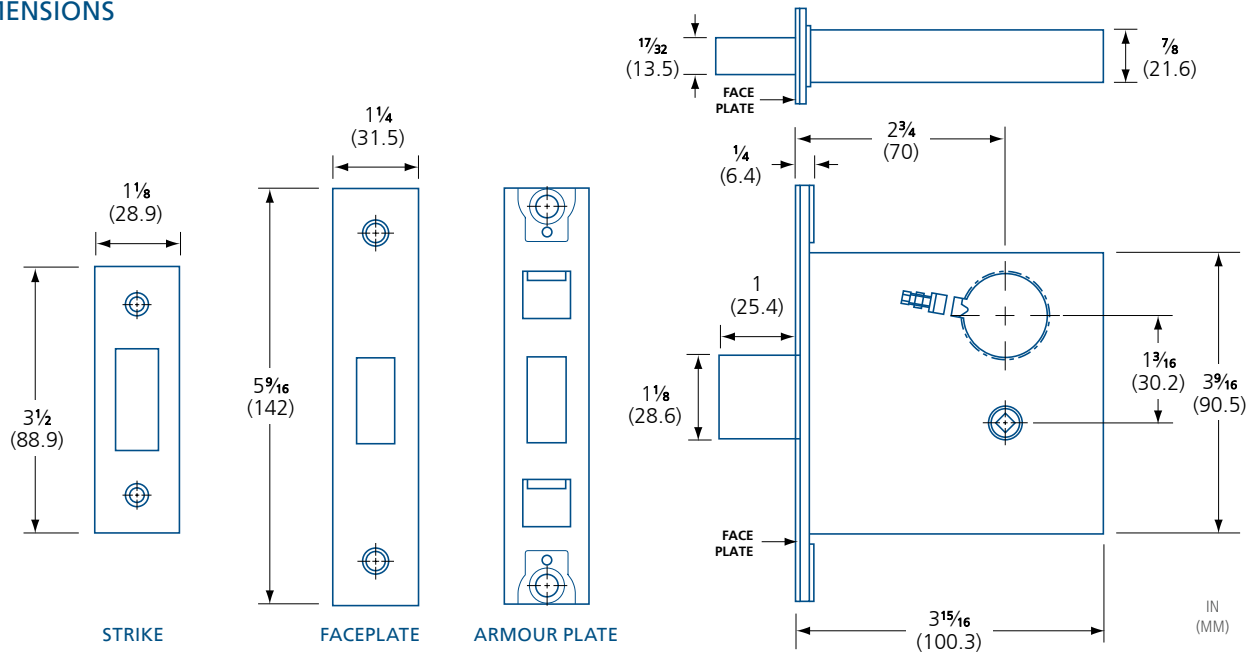

PARTS & ACCESSORIES



DM45X-PR
Mortise cylinder collar with spring; round.
Ø 1 1/16 x 3/8" (43x9 mm)
Finish: 15, 19, 26D



DM45X-PRS
Mortise cylinder collar with spring; square.
1 7/8 x 1 7/8 x 3/8" (48x48x9 mm)
Finish: 15, 19, 26D



DM00X-PSCYL

- 1 1/8" (28.6 mm) 5-pin (drilled 6) brass mortise cylinder; Schlage "C" with 2 keys.
- For installations on 1 3/4" (45 mm) thick doors.
- Includes DM00X-PCAM.
- Finish: 15, 19, 26D

DM00X-PECYL

- 1 1/4" (31.8 mm) 5-pin (drilled 6) brass mortise cylinder; Schlage "C" with 2 keys.
- For installations on 2" (51 mm) thick doors
- Includes DM00X-PCAM.
- Finish: 15, 19, 26D



DM00X-PCAM
Replacement mortise cylinder cam, with screws.

NOTE: OTHER CYLINDERS MAY REQUIRE A DIFFERENT CAM. PLEASE CONTACT IF USING A DIFFERENT CYLINDER. OTHER CAMS SOLD SEPARATELY.



DM45X-PT
Mortise lock thumbturn; round. Mounting screws included. Finish: 15, 19, 26D



DM45X-PTS
Mortise lock thumbturn; square. Mounting screws included. Finish: 15, 19, 26D



DM00X-PPRVI
Occupancy indicator. Includes round interior/ exterior trims for use with function 55. For 1 3/4" (44.5 mm) thick wood door. Mounting hardware included. Finish: 15, 26D



DM00X-PPRVIQ
Occupancy indicator. Includes square interior/ exterior trims for use with function 55. For 1 3/4" (44.5 mm) thick wood door. Mounting hardware included. Finish: 15, 26D



DM00X-PPRVI-ECYL
Keypad occupancy indicator. Includes round interior/ exterior trims for use with keyed function 51. For 1 3/4" (44.5 mm) thick wood door. Mounting hardware and DM00X-ECYL Cylinder with 2 keys included. Finish: 15, 26D



DM00X-PPRVIQ-ECYL
Keypad occupancy indicator. Includes round interior/ exterior trims for use with keyed function 51. For 1 3/4" (44.5 mm) thick wood door. Mounting hardware and DM00X-ECYL Cylinder with 2 keys included. Finish: 15, 26D



TECNICA DESIGN

D O R E X



Mortise Lock Option

All TECNICA DESIGN levers are available with the DOREX DM premium mortise lock for maximum security, 3-hour fire-rating and Grade 1 performance. Excellent for suite, office or home entry and available with a wide variety of functions, trims and escutcheon sizes.

See page 01.070 or speak with your local representative for ordering, product or specification details.



Interconnected Lock Option

The LINEA lever is available as a premium interconnected lock. The DOREX T2 IL series interconnected tubular lockset combines modern style, security and durability. Recommended as suite entry door locks in multi-unit residential applications. The T2IL offers 3 hour fire-rating and simultaneous retraction of both latch and deadbolt provides easy, panic-proof exiting.

See page 01.032 or speak with your local representative for ordering, product or specification details.



Available with square exterior trim

Cylindrical Lock Option

TECNICA DESIGN's The Flat lever is available as a Grade 2 quality, 3hr fire-rated, commercial cylindrical lock. Ideal for multi-unit buildings requiring a stylish lever that offers common commercial functions, and can handle the wear and tear of frequent use.

See page 01.021 or speak with your local representative for ordering, product or specification details.



Levers

- Modern lever styles ideal for contemporary styled homes and residential applications
- Privacy function with auto-release
- Concealed mounting screws
- Available with square or round rose
- All lever styles available with magnetic latches and strikes for seamless, minimalist installations



- Conforms to ANSI/BHMA Grade 3
- Meets ADA requirements
- 20 Minute fire-rating when installed with optional listed fire can*
- Lifetime mechanical warranty
- 10-year limited finish warranty

- Non-handed, zinc die-cast levers
- For doors 1 $\frac{3}{8}$ –1 $\frac{3}{4}$ " (35–44.5 mm) thick
- Extension kit for 2 $\frac{1}{4}$ " (57 mm) thick doors available (#TDK100TE)
- Fits standard 2 $\frac{1}{8}$ " (54 mm) door preparation with 1" (25.4 mm) edge bore
- Stainless steel tubular spring latch with adjustable 2 $\frac{3}{8}$ –2 $\frac{3}{4}$ " (60–70 mm) backset
- Mortised faceplate with square corners, convertible to drive-in
- Galvanized steel interior mechanism
- Full-lip strike with round corners included.
- Concealed mounting screws

(*) Firecan kit must be ordered in conjunction with lockset, not available separately. For use on fire labelled, wood doors only.

- Available with magnetic tubular latch and invisible strike
- ASA strike for metal door frames available
- Other faceplate options available

AVAILABLE FUNCTIONS

- 10 Passage
- 42 Privacy, with auto-release
- 5 Dummy, single (surface / thru-bolt)¹
- 3 Handleset interior trim²

(1) Can be installed back-to-back using thru-bolts
(2) For use with Tecnica Design entry handlesets



LINEA – ROUND
SATIN NICKEL



© DOREX



THE FLAT – SQUARE
SATIN NICKEL



NEW



STRATA – SQUARE
SATIN NICKEL



CIRCA
SATIN NICKEL



SELECTION GUIDE

100	10	FT	S	15	M	—
SERIES	FUNCTION ¹	STYLE	ROSE ²	FINISH	LATCH ³	OPTION ⁴

(1) OMIT FUNCTION WHEN ORDERING DUMMY OR HANDLESET TRIM OPTION (2) BLANK : ROUND
 S: SQUARE (3) M: MORTISE V: DRIVE-IN (4) -3: HANDLE TRIM -5: DUMMY



Firecan kit must be ordered in conjunction with lock, not available separately. For fire labelled wood doors ONLY.

		10B OIL RUB. BRONZE	11P ANTIQU BRONZE	15 SATIN NICKEL	15A ANTIQU NICKEL	19 MATTE BLACK	26 POLISH CHROME	26D SATIN CHROME	3 POLISH BRASS	32D SATIN S.STEEL	4 SATIN BRASS	5 ANTIQU BRASS	V3* POLISH BRASS	/CASE†
CIRCA	CT			•		•	•	•						10
LINEA	LT			•		•	•	•						10
THE FLAT	FT			•		•	•	•						10
STRATA	ST			•		•	•	•						10

OTHER FINISHES AVAILABLE, MINIMUM ORDER QUANTITIES AND/OR ADDITIONAL DELIVERY TIMES MAY BE REQUIRED – PLEASE CONTACT (*) LIFETIME FINISH WARRANTY (†) DUMMY ARE 20/CASE

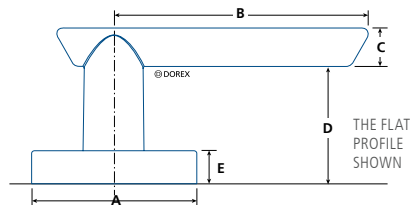

	A	B	C	D	E
CIRCA CT	2 ⁹ / ₁₆ (64.5)	4 (101.6)	1 ⁹ / ₃₂ (15)	1 ³ / ₄ (45)	1/2 (12.7)
LINEA LT / LTS	2 ⁹ / ₁₆ (64.5)	4 (101.6)	2 ⁵ / ₃₂ (20)	1 ⁹ / ₁₆ (40)	1/2 (12.7)
THE FLAT FT / FTS	2 ⁹ / ₁₆ (64.5)	4 (101.6)	3 ⁷ / ₆₄ (14.7)	1 ²⁵ / ₃₂ (45.3)	1/2 (12.7)
STRATA ST / STS	2 ⁹ / ₁₆ (64.5)	4 ⁹ / ₁₆ (115.9)	7/8 (22)	1 ⁵ / ₈ (42)	1/2 (12.7)

IN (MM)

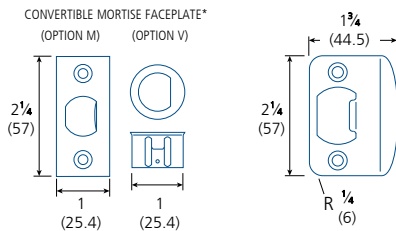

(*) Regardless of option ordered, the part required to convert from one option to the other is included.

Magnetic Latch Option



All TECNICA DESIGN levers are available with magnetic latches and strikes providing the perfect solution for ultra-quiet applications. With no protruding bolt or strike lip, these latches offer a clean, minimalist look for those looking to create unique, flush-to-wall, and snag-free installations free of unsightly latch bolts or strike lips.



Not fire rated.

Mortise faceplate only, not convertible to drive-in.

- Strike and latch use strong neodymium (rare earth) magnets
- Ergonomic 30-degree activation
- Requires the same tools and preparation as classic tubular latches
- Pair with invisible hinges for unique flush-to-wall door installations
- Not for use in fire-rated applications
- Only available for Passage or Privacy (with auto-release) functions

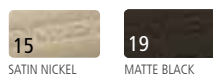

M6	100	10	FT	S	15	M
BACKSET ¹	SERIES	FUNCTION	STYLE	ROSE ²	FINISH	LATCH

(1) M6: 2³/₄IN (60MM) FIXED BACKSET, M7: 2³/₄IN (70MM) FIXED BACKSET
 (2) 10: PASSAGE, 42: PRIVACY (3) BLANK : ROUND, S: SQUARE



Entry Handlesets

- Reliable, quality modern entry handlesets for residential homes
- Concealed mounting screws
- Includes Linea interior lever and matching round or square thumbturn
- Interior lever can be swapped with any other Tecnica Design lever¹

(1) Availability may vary, please contact your local Dorex representative.

- Conforms to ANSI/BHMA Grade 3
- 25-year mechanical warranty
- 5-year limited finish warranty
- Non-handed, zinc die-cast exterior trim
- For doors 1¾–2¼" (44.5–57 mm) thick
- Fits standard 2⅝" (54 mm) door preparation with 1" (25.4 mm) edge bore
- Steel tubular spring latch with adjustable 2⅞–2¾" (60–70 mm) backset.
- Steel 1" (25.4 mm) deadbolt latch with hardened steel security pin and adjustable 2⅞–2¾" (60–70 mm) backset
- Mortised faceplate with square corners, convertible to drive-in
- Galvanized steel interior mechanism
- Weiser 5-pin brass cylinder in steel housing with 2 keys
- Full-lip strike and deadbolt strike for wood door frames included

AVAILABLE FUNCTIONS

T401 Entry
(single cylinder w/ thumbturn)

G3

25
YEAR

SELECTION GUIDE

T401	PT	LTS	15	KD	W
SERIES	STYLE ¹	TRIM ²	FINISH	KEYING	LATCH

(1) AR: ARCO; DT: DELTA; PT: PLATO (2) LTS: LINEA-SQUARE

	10B OIL RUB. BRONZE	11P ANTIQU BRONZE	15 SATIN NICKEL	15A ANTIQU NICKEL	19 MATTE BLACK	26 POLISHED CHROME	26D SATIN CHROME	3 POLISHED BRASS	32D SATIN S.STEEL	4 SATIN BRASS	C5 ANTIQU BRASS	V3* POLISHED BRASS	/CASE
ARCO	AR		•		•	•	•						6
DELTA	DT		•		•	•	•						6
PLATO	PT		•		•	•	•						6

OTHER FINISHES AVAILABLE, MINIMUM ORDER QUANTITIES AND/OR ADDITIONAL DELIVERY TIMES MAY BE REQUIRED – PLEASE CONTACT (*) LIFETIME FINISH WARRANTY

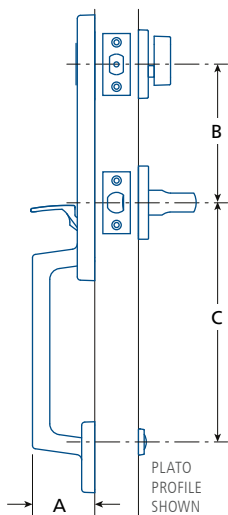

	A	B	C
ARCO	2 ¹¹ / ₁₆	5 ¹	8 ³ / ₄ – 10 ³ / ₈ ²
AR	(68)	(127)	(222 – 264)
DELTA	2 ¹ / ₈	5 ¹	8 ¹³ / ₃₂
DT	(54)	(127)	(214)
PLATO	2 ¹¹ / ₁₆	5 ¹ / ₂	8 ³ / ₄ – 10 ³ / ₈ ²
PT	(68)	(140)	(222 – 264)

IN (MM) (1) RECOMMENDED DISTANCE (2) ADJUSTABLE

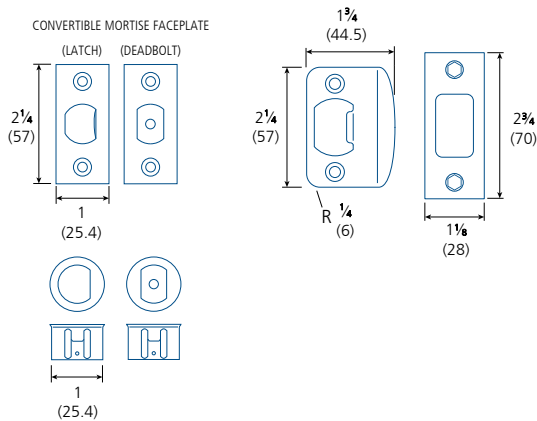

Deadbolt Locks

- TECNICA DESIGN deadbolts are a blend of aesthetics, security, and dependability
- ANSI/BHMA Grade 3 Security, excellent for suite entry doors and offices
- Concealed mounting screws
- Can be keyed to insert into any key system.
- Can accommodate CX5 High Security cylinders for enhanced security



GIRO
SATIN NICKEL



- Certified ANSI/BHMA Grade 3.
- 20 Minute fire-rating when installed with optional listed fire can*
- 25-year mechanical warranty
- 5-year limited finish warranty.

- For doors 1 $\frac{3}{8}$ –1 $\frac{3}{4}$ " (35–44.5 mm) thick
- Extension kit for 2 $\frac{1}{4}$ " (57 mm) thick doors available (#TLA85052)
- Fits standard 2 $\frac{1}{8}$ " (54 mm) door preparation with 1" (25.4 mm) edge bore
- Steel 1" (25.4 mm) deadbolt latch with hardened steel security pin and adjustable 2 $\frac{3}{8}$ –2 $\frac{3}{4}$ " (60–70 mm) backset
- Mortised faceplate with square corners, convertible to drive-in
- Galvanized steel interior mechanism.
- Removable brass cylinder in steel housing with 2 keys
- Security strikes for wood and metal door frames included

(* *Firecan kit must be ordered in conjunction with lock, not available separately. For use on fire labelled, wood doors only.*

- Keying options available – including CX5 high security cylinders
- Other faceplate options available



QUADRA
SATIN NICKEL



AVAILABLE FUNCTIONS

- 51 Single cylinder with thumbturn



SELECTION GUIDE

201	51	TR	15	KD	M
SERIES ¹	FUNCTION	STYLE	FINISH	KEYING ²	LATCH ³
(1) 201: WEISER 5-PIN 202: SCHLAGE 6-PIN KEYWAY (2) KA: KEYED ALIKE KD: KEYED DIFFERENT					
(3) M: MORTISE V: DRIVE-IN ONLY					



Firecan kit must be ordered in conjunction with deadbolt, not available separately. For fire labelled wood doors ONLY.

Full keying services available – please contact for details

STYLE	10B OIL RUB. BRONZE	11P ANTIQUE BRONZE	15 SATIN NICKEL	15A ANTIQUE NICKEL	19 MATTE BLACK	26 POLISHED CHROME	26D SATIN CHROME	32D SATIN S.STEEL	3 POLISHED BRASS	4 SATIN BRASS	5 ANTIQUE BRASS	V3* POLISHED BRASS	/CASE
GIRO	TR		•		•	•	•						24
QUADRA	TS		•		•	•	•						24

OTHER FINISHES AVAILABLE, MINIMUM ORDER QUANTITIES AND/OR ADDITIONAL DELIVERY TIMES MAY BE REQUIRED – PLEASE CONTACT (*) LIFETIME FINISH WARRANTY

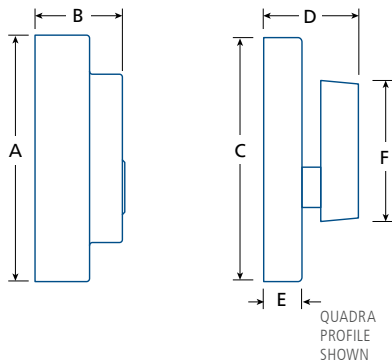

	A	B	C	D	E	F
GIRO TR	∅ 2½ (64)	15/16 (23.8)	2½ (64)	1 (25.4)	3/8 (9)	17/8 (47)
QUADRA TS	∅ 29/16 (64.5)	15/16 (23.8)	29/16 (64.5)	1 (25.4)	3/8 (9)	1¾ (45)

IN (MM)

CONVERTIBLE MORTISE FACEPLATE*
(OPTION M) (OPTION V)

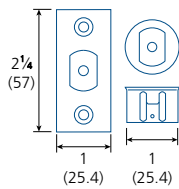

SECURITY STRIKES
(WOOD / METAL)

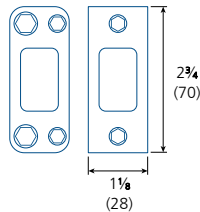

(*) Regardless of option ordered, the part required to convert from one option to the other is included.

PARTS & ACCESSORIES



200T-SWA
Replacement thumbturn setscrew, spring washer, and hex key.





MAGNETIC LATCHES

Tecnica Design magnetic latches provide the perfect solution for ultra-quiet residential applications. With no protruding bolt or strike lip, these latches offer a clean, minimalist look to homeowners looking to create unique flush-to-wall installations free of unsightly strikes or bolts.

Magnetic Latches

All TECNICA DESIGN levers are available with magnetic latches and strikes providing the perfect solution for ultra-quiet applications. With no protruding bolt or strike lip, these latches offer a clean, minimalist look for those looking to create unique, flush-to-wall, and snag-free installations free of unsightly latch bolts or strike lips.

- Strike and latch use strong neodymium (rare earth) magnets.
- Ergonomic 30-degree activation.
- Requires the same tools and door preparation as classic tubular latches.
- Pair with invisible hinges for unique flush-to-wall door installations.
- Not for use in fire-rated applications. Cannot be used with a DOREX firecan kit.
- Only available for Passage or Privacy (with auto-release) functions.



HOW DOREX MAGNETIC LATCHES WORK

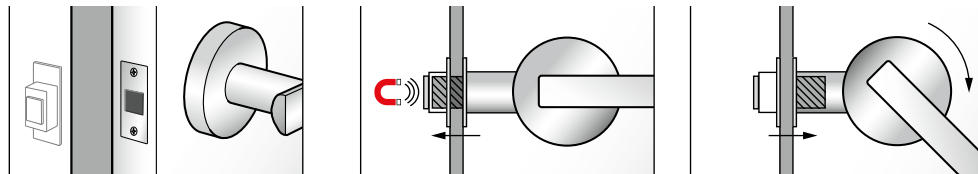

WHEN OPEN, the latch is held retracted while the door is open for a clean, minimalist look. Since the strike has no lip, it is not visible.

WHEN CLOSING, a rare-earth magnet will instantly and quietly pull the latch into the strike to latch the door securely.

WHEN USING the lever, the latch will quietly retract and be held magnetically. Even when the lever is released, the latch will remain retracted in its housing.

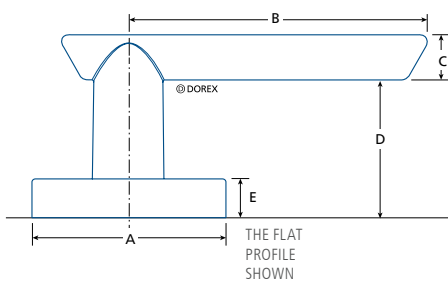

	A	B	C	D	E
CIRCA CT	∅ 2 ⁹ / ₁₆ (64.5)	4 (101.6)	1 ⁹ / ₃₂ (15)	1 ³ / ₄ (45)	1/2 (12.7)
LINEA LT / LTS	∅ 2 ⁹ / ₁₆ (64.5)	4 (101.6)	2 ⁵ / ₃₂ (20)	1 ⁹ / ₁₆ (40)	1/2 (12.7)
THE FLAT FT / FTS	∅ 2 ⁹ / ₁₆ (64.5)	4 (101.6)	3 ⁷ / ₆₄ (14.7)	1 ²⁵ / ₃₂ (45.3)	1/2 (12.7)
STRATA ST / STS	2 ⁹ / ₁₆ (64.5)	4 ⁹ / ₁₆ (115.9)	7/8 (22)	1 ⁵ / ₈ (42)	1/2 (12.7)

IN (MM)

SELECTION GUIDE

	10B OIL RUB. BRONZE	11P ANTIQUE BRONZE	15 SATIN NICKEL	15A ANTIQUE NICKEL	19 MATTE BLACK	26 POLISHED CHROME	26D SATIN CHROME	3 POLISHED BRASS	32D SATIN S.STEEL	4 SATIN BRASS	5 ANTIQUE BRASS	V3* POLISHED BRASS	/CASE
CIRCA	CT		•		•								10
LINEA	LT		•		•								10
THE FLAT	FT		•		•								10
STRATA	ST		•		•								10

OTHER FINISHES AVAILABLE, MINIMUM ORDER QUANTITIES AND/OR ADDITIONAL DELIVERY TIMES MAY BE REQUIRED – PLEASE CONTACT (*) LIFETIME FINISH WARRANTY

M6	100	10	FT	S	15	M
BACKSET ¹	SERIES	FUNCTION ²	STYLE	ROSE ³	FINISH	LATCH

(1) M6: 2³/₁₆IN (60MM) FIXED BACKSET, M7: 2³/₁₆IN (70MM) FIXED BACKSET
 (2) 10: PASSAGE, 42: PRIVACY (3) BLANK : ROUND, S: SQUARE



DOREX®

Signature





Levers

- Classic, modern lever styles that can fit into any decor
- Non-handed and handed lever styles
- Privacy function with auto-release
- Keyed entry function available
- Can be keyed to insert into any key system



- Conforms to ANSI/BHMA Grade 3
- 20 Minute fire-rating when installed with optional listed fire can*
- 25 year mechanical warranty
- 5 year limited finish warranty
- Non-handed or handed, zinc die-cast lever
- For doors 1 $\frac{3}{8}$ –1 $\frac{3}{4}$ " (35–44.5 mm) thick
- Fits standard 2 $\frac{1}{8}$ " (54 mm) door preparation with 1" (25.4 mm) edge bore
- Stainless steel tubular spring latch with adjustable 2 $\frac{3}{8}$ –2 $\frac{3}{4}$ " (60–70 mm) backset
- Mortise faceplate with square corners, convertible to drive-in
- Galvanized steel interior mechanism
- Entry models include removable 5-pin cylinder with 2 keys
- Full-lip strike with round corners included

(* Firecan kit must be ordered in conjunction with lockset, not available separately. For use on fire labelled, solid wood doors only.

- Keying options available
- Other faceplate options available
- 5" (127 mm) backset latch available

AVAILABLE FUNCTIONS

- 10 Passage
- 42 Privacy, with auto-release
- 51 Entry ↔
- 1 Single Dummy (surface)
- 2 Single Dummy (thru-bolt)
- 3 Handleset trim*

(* Handleset trim includes lever spring latch)



SELECTION GUIDE

101	51	AT	C15	KD	M	RH	—
SERIES ¹	FUNCTION	STYLE	FINISH	KEYING	LATCH ²	HAND ³	OPTION ⁴
(1) 100: NO KEYWAY; 101: WEISER; 102: SCHLAGE KEYWAY; OMIT FUNCTION AND USE 100 WHEN ORDERING DUMMY OR TRIM (2) M: MORTISE W: DRIVE-IN (3) ATHENA OR DUMMY APOLLO, INDICATE RH: RIGHT HAND, LH: LEFT HAND (4) -1: DUMMY, SINGLE -2: DUMMY, THRU-BOLT -3: TRIM							



Firecan kit must be ordered in conjunction with lock, not available separately. For fire labelled wood doors ONLY.

Full keying services available – please contact for details.

	C10B OIL RUB. BRONZE	C11P ANTIQUÉ BRONZE	C15 SATIN NICKEL	C15A ANTIQUÉ NICKEL	C19 MATTE BLACK	C26D SATIN CHROME	C3 POLISHED BRASS	C32D SATIN S.STEEL	C4 SATIN BRASS	C5 ANTIQUÉ BRASS	V3** POLISHED BRASS	/CASE†
ATHENA (REVERSIBLE)*	AT	●	●	●	●	●						20
APOLLO (REVERSIBLE)*	AP	●	●			●						20
CAMBRIDGE	CB	●	●	●		●						20
ESCORT	ES					●	●					20
HAWTHORNE	HW					●						20
JUNO	JN		●		●	●						20
MANHATTAN	M			●		●	●	●				20

OTHER FINISHES AVAILABLE, MINIMUM ORDER QUANTITIES AND/OR ADDITIONAL DELIVERY TIMES MAY BE REQUIRED – PLEASE CONTACT (*) RIGHT HAND, FIELD REVERSIBLE. DUMMY LEVERS ARE NOT REVERSIBLE, PLEASE INDICATE HANDING. (**) LIFETIME FINISH WARRANTY (†) DUMMY ARE 20/CASE

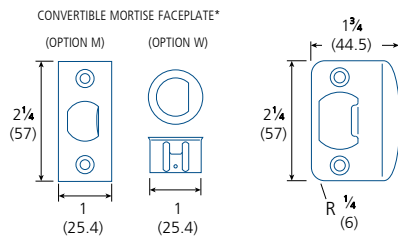
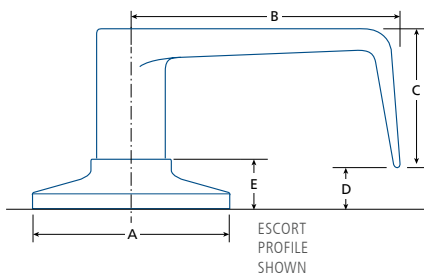

(*) Regardless of option ordered, the part required to convert from one option to the other is included.

	A	B	C	D	E
ATHENA AT	2 9/16 (65)	3 15/16 (100)	1 (25)	1 9/16 (40)	1 9/32 (15)
APOLLO AP	2 9/16 (65)	4 1/8 (105)	3/4 (20)	1 3/8 (35)	1 9/32 (15)
CAMBRIDGE CB	2 9/16 (65)	3 15/16 (100)	5/16 (8)	1 31/32 (50)	1 9/32 (15)
ESCORT ES	2 9/16 (65)	3 15/16 (100)	1 1/2 (38)	1 5/32 (12)	1 9/32 (15)
HAWTHORNE HW	2 9/16 (65)	3 15/16 (100)	3/8 (9.5)	1 31/32 (50)	1 9/32 (15)
JUNO JN	2 9/16 (65)	4 1/8 (105)	1 1/16 (18)	1 9/16 (40)	1 9/32 (15)
MANHATTAN M	2 9/16 (65)	3 15/32 (88)	5/16 (8)	1 31/32 (50)	1 9/32 (15)

IN (MM)



Knobs

- Classic, knob styles that can fit into any decor
- Privacy function with auto-release
- Keyed entry function available
- Can be keyed to insert into any key system



BALA
SATIN NICKEL

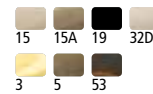

EGLINGTON
ANTIQUÉ NICKEL



- Conforms to ANSI/BHMA Grade 3
- 20 Minute fire-rating when installed with optional listed firecan kit*
- 25 year mechanical warranty
- 5 year limited finish warranty
- Steel knob and rose
- For doors 1 $\frac{3}{8}$ –1 $\frac{3}{4}$ " (35–44.5 mm) thick
- Fits standard 2 $\frac{1}{8}$ " (54 mm) door preparation with 1" (25.4 mm) edge bore
- Stainless steel spring latch with adjustable backset
- Mortise faceplate with square corners, convertible to drive-in
- Galvanized steel interior mechanism
- Entry models include removable 5-pin cylinder with 2 keys
- Full-lip strike with round corners included

(*) Firecan kit must be ordered in conjunction with lockset, not available separately. For use on fire labelled, solid wood doors only.

- Keying options available
- Other faceplate options available
- 5" (127 mm) backset latch available

AVAILABLE FUNCTIONS

- 10 Passage
- 42 Privacy, with auto-release
- 51 Entry ↔
- 1 Single Dummy (surface)
- 2 Single Dummy (thru-bolt)
- 3 Handleset trim



SELECTION GUIDE

101	51	B	C15	KD	M	-
SERIES ¹	FUNCTION	STYLE	FINISH	KEYING	LATCH ²	OPTION ³
(1) 100: NO KEYWAY 101: WEISER 102: SCHLAGE KEYWAY; OMIT FUNCTION AND USE 100 WHEN ORDERING DUMMY OR TRIM (2) M: MORTISE W: DRIVE-IN (3) -1: DUMMY, SINGLE -2: DUMMY, THRU-BOLT -3: TRIM						



Firecan kit must be ordered in conjunction with lock, not available separately. For fire labelled wood doors ONLY.

Full keying services available – please contact for details

		C10B	C11P	C15	C15A	C19	C26	C26D	C3	C32D	C4	C5	53	/CASE
		OIL RUB. BRONZE	ANTIQU BRONZE	SATIN NICKEL	ANTIQU NICKEL	MATTE BLACK	POLISHED CHROME	SATIN CHROME	POLISHED BRASS	SATIN S.STEEL	SATIN BRASS	ANTIQU BRASS	ANT. / POL. BRASS	
BALA	B			•	•	•			•	•		•	•	20
EGLINGTON	EG			•	•	•		•						20

OTHER FINISHES AVAILABLE, MINIMUM ORDER QUANTITIES AND/OR ADDITIONAL DELIVERY TIMES MAY BE REQUIRED – PLEASE CONTACT

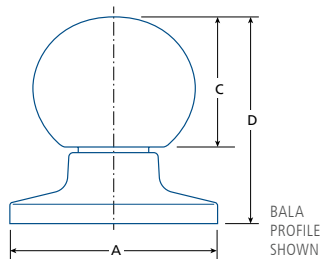

	A	B	C	D
BALA	2 ⁹ / ₁₆	2	1 ¹ / ₁₆	2 ¹ / ₂
B	(65)	(51)	(40)	(63.5)
EGLINGTON	2 ⁹ / ₁₆	1 ³ / ₈	1 ¹ / ₁₆	2 ¹ / ₂
EG	(65)	(60)	(40)	(63.5)

IN (MM)

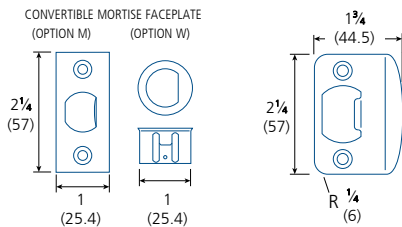

(*): Regardless of option ordered, the part required to convert from one option to the other is included.



Entry Handlesets

- Reliable, quality classic entry handlesets for residential homes
- Non-handed
- Includes Bala interior knob
- Interior knob can be swapped with any other Signature lever or knob¹
- Can be keyed to insert into any key system
- Can accommodate CX5 High Security cylinders for enhanced security

(1) Availability may vary, please contact your local Dorex representative.

- Conforms to ANSI/BHMA Grade 3
- 20 Minute fire-rating when installed with optional listed firecan kits*
- 25 year mechanical warranty
- 5 year limited finish warranty

- Non-handed, zinc die-cast exterior trim
- For doors 1 $\frac{3}{8}$ –2 $\frac{1}{4}$ " (44.5–57 mm) thick
- Fits standard 2 $\frac{1}{8}$ " (54 mm) door preparation with 1" (25.4 mm) edge bore
- Stainless steel tubular spring latch with adjustable 2 $\frac{3}{8}$ –2 $\frac{3}{4}$ " (60–70 mm) backset
- Brass 1" (25.4 mm) deadbolt latch with hardened steel security pin and adjustable 2 $\frac{3}{8}$ –2 $\frac{3}{4}$ " (60–70 mm) backset
- 4-way mortise faceplate with square corners, convertible to drive-in
- Galvanized steel interior mechanism
- Removable 5-pin brass cylinder in steel housing with 2 keys
- Full-lip strike and security strike for wood door frames (round corners) included

(*) Firecan kits must be ordered in conjunction with handleset, not available separately. For use on fire labelled, solid wood doors only.

AVAILABLE FUNCTIONS

- Entry ↔
- Dummy – available



CAPRI
SATIN NICKEL
11P 15 15A 19



MAYFAIR
MATTE BLACK
11P 15 15A 19
26 26D 3 5



IMPERIAL
ANTIQUÉ NICKEL
11P 15 15A



BIARRITZ
ANTIQUÉ BRASS
15A 5

SELECTION GUIDE

401	BI	B	C15	KD	W	-
SERIES ¹	STYLE	TRIM	FINISH	KEYING	LATCH	OPTION ²
(1) 400: NO KEYWAY 401: WEISER 402: SCHLAGE KEYWAY USE 400 WHEN ORDERING DUMMY						
(2) DUM: DUMMY						



Fire-cans (2) must be ordered in conjunction with lock, not available separately. For fire labelled wood doors ONLY.

GATE LATCH AVAILABLE, must be ordered in conjunction with handleset – please contact for details.

Full keying services available – please contact for details

	C10B OIL RUB. BRONZE	C11P ANTIQU BRONZE	C15 SATIN NICKEL	C15A ANTIQU NICKEL	C19 MATTE BLACK	C26 POLISHED CHROME	C26D SATIN CHROME	C3 POLISHED BRASS	C32D SATIN S.STEEL	C4 SATIN BRASS	C5 ANTIQU BRASS	V3* POLISHED BRASS	/CASE
BIARRITZ	BI			•							•	•	6
CAPRI	CA	•	•	•	•								6
IMPERIAL	IM	•	•	•									6
MAYFAIR	MA	•	•	•	•	•	•	•			•	•	6

OTHER FINISHES AVAILABLE, MINIMUM ORDER QUANTITIES AND/OR ADDITIONAL DELIVERY TIMES MAY BE REQUIRED – PLEASE CONTACT (*) LIFETIME FINISH WARRANTY

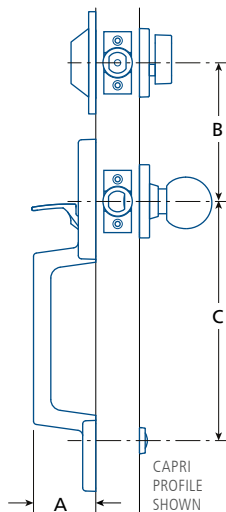

	A	B*	C
BIARRITZ BI	2 ³ / ₈ (60)	5 (127)	8 ¹³ / ₃₂ (214)
CAPRI CA	2 ⁵ / ₃₂ (55)	5 (127)	8 ¹³ / ₃₂ (214)
IMPERIAL IM	2 ⁹ / ₁₆ (65)	5 (127)	8 ¹³ / ₃₂ (214)
MAYFAIR MA	2 ⁷ / ₁₆ (62)	5 (127)	8 ¹³ / ₃₂ (214)

IN (MM) (*) RECOMMENDED DISTANCE

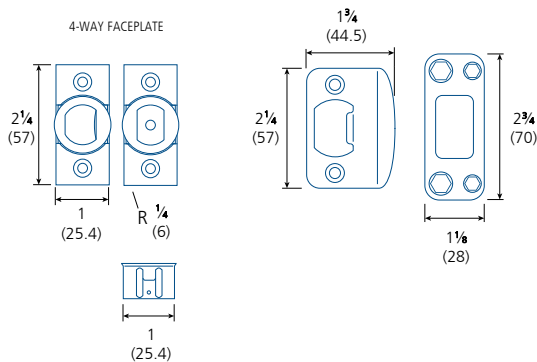

Deadbolt Locks

- ANSI/BHMA Grade 3 Security, excellent for suite entry doors and offices
- Can be keyed to insert into any key system
- Can accommodate CX5 High Security cylinders for enhanced security



- Conforms to ANSI/BHMA Grade 3
- 20 Minute fire-rating available
- 25 year mechanical warranty
- 5 year limited finish warranty
- For doors 1 3/8–1 3/4" (35–44.5 mm) thick
- Extension kit for 2 1/4" (57 mm) thick doors available (#TLA85052)
- Fits standard 2 1/8" (54 mm) door preparation with 1" (25.4 mm) edge bore
- Steel or brass 1" (25.4 mm) deadbolt latch with hardened steel security pin and adjustable 2 3/8–2 3/4" (60–70 mm) backset
- Mortise faceplate with square corners, convertible to drive-in
- Galvanized steel interior mechanism
- Removable brass cylinder in steel housing with 2 keys
- Rotating exterior collar for enhanced protection against physical attack
- Security strikes for wood and steel frames included
- Other faceplate options available



200 SERIES
SATIN NICKEL
SINGLE CYLINDER

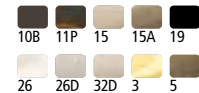

200 SERIES
SATIN NICKEL
THUMB-TURN ONLY



200 SERIES
SATIN STAINLESS STEEL
DOUBLE CYLINDER



AVAILABLE FUNCTIONS

- 51 Single cylinder with thumb-turn ➔
- 55 One-side, thumb-turn only
- 57 Thumb-turn with exterior plate
- 60 Double cylinder ➔

SELECTION GUIDE

F	201	51	C15	KD	M
RATING ¹	SERIES ²	FUNCTION	FINISH	KEYING ³	LATCH ⁴
(1) LEAVE BLANK FOR NON-RATED MODEL (2) 200 : NO KEYWAY 201 : WEISER 5-PIN 202 : SCHLAGE KEYWAY 6-PIN USE 200 WHEN ORDERING FUNCTIONS 55 OR 57 (2) KA : KEYED ALIKE KD : KEYED DIFFERENT (3) M : CONVERTIBLE MORTISE					



For fire labelled wood doors ONLY. For details, consult local building codes and/or local authority having jurisdiction (AHJ). Separate firecan kit may be required for some finishes.

🔑 Full keying services available – please contact for details

	C10B	C11P	C15	C15A	C19	C26	C26D	C32D	C3	C4	C5	C53	V3*	/CASE
	OIL RUB. BRONZE	ANTIQUE BRONZE	SATIN NICKEL	ANTIQUE NICKEL	MATTE BLACK	POLISHED CHROME	SATIN CHROME	SATIN S.STEEL	POLISHED BRASS	SATIN BRASS	ANTIQUE BRASS	ANT. / POL. BRASS	POLISHED BRASS	
200 SERIES	●	●	●	●	●	●	●	●	●	●	●	●		24

OTHER FINISHES AVAILABLE, MINIMUM ORDER QUANTITIES AND/OR ADDITIONAL DELIVERY TIMES MAY BE REQUIRED – PLEASE CONTACT (*) LIFETIME FINISH WARRANTY

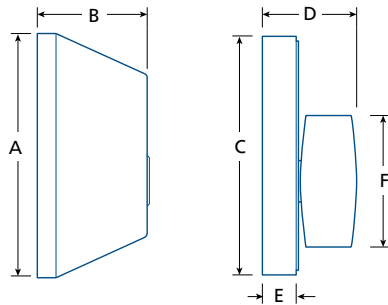

	A	B	C	D	E	F
200 SERIES	∅ 2 ⁹ / ₁₆ (65)	1 ¹ / ₈ (29)	∅ 2 ¹ / ₂ (63)	1 (25.4)	3 ³ / ₈ (9)	1 ³ / ₈ (35)

IN (MM)

CONVERTIBLE MORTISE FACEPLATE (OPTION M)

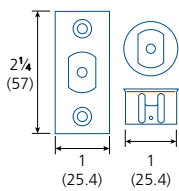

SECURITY STRIKES (WOOD / METAL)

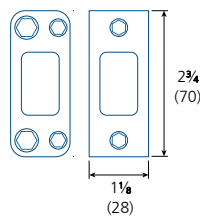

DOREX®

METRO

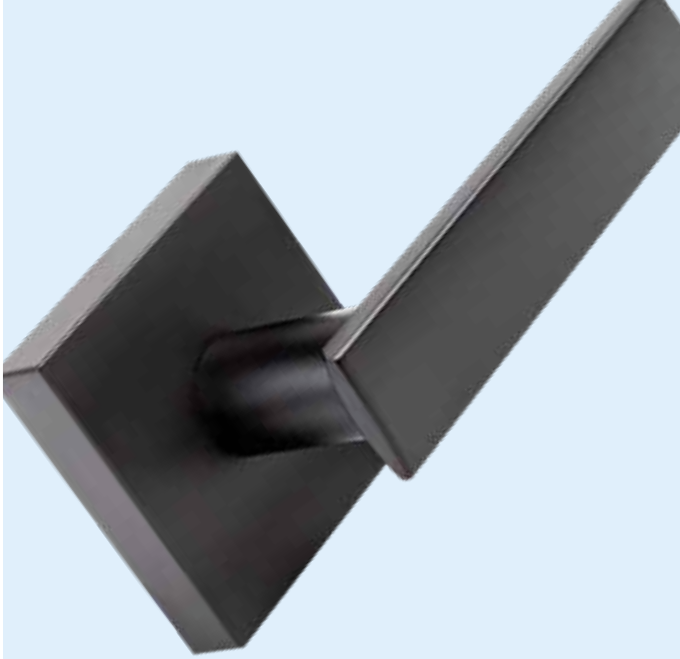

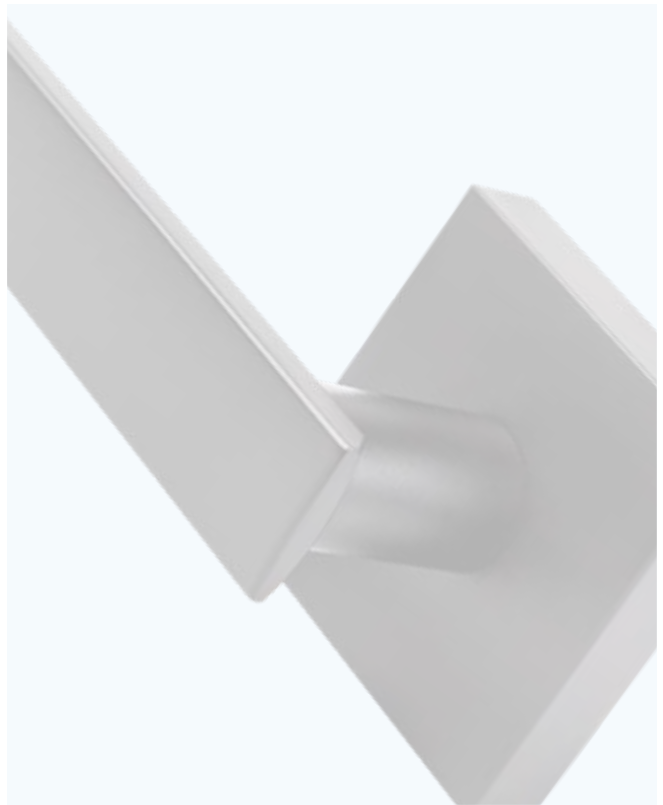

Levers

- All new collection of urban inspired, contemporary levers
- Non-handed and handed lever styles
- Privacy function with auto-release

- 1 year mechanical warranty
- 1 year limited finish warranty
- Non-handed or handed, zinc die-cast lever
- For doors $1\frac{3}{8}$ – $1\frac{3}{4}$ " (35–44.5 mm) thick
- Fits standard $2\frac{1}{8}$ " (54 mm) door preparation with 1" (25.4 mm) edge bore
- Steel tubular spring latch with adjustable $2\frac{3}{8}$ – $2\frac{3}{4}$ " (60–70 mm) backset
- 4-Way, mortise faceplate with square corners, convertible to drive-in
- Full-lip strike with round corners included
- Other faceplate options available

AVAILABLE FUNCTIONS

- 10 Passage
- 51 Entry (Livia only)
- 42 Privacy, with auto-release
- 17 Single Dummy (surface)



NERO
MATTE BLACK



ROSE



LIVIA
ANTIQUÉ NICKEL



ROSE



CASSIUS
SATIN CHROME



SELECTION GUIDE

V2X	42	Q	S	L	-	15	M
SERIES	FUNCTION	STYLE	ROSE ¹	HAND ²	FINISH	LATCH ³	

(1) BLANK: ROUND S: SQUARE (2) FOR CASSIUS INDICATE R: RIGHT HAND, L: LEFT HAND
 (3) BLANK: 4-WAY; D: DRIVE-IN; M: FIXED MORTISE (SQ CORNER); MR: FIXED MORTISE (RND CORNER)

		10B OIL RUB. BRONZE	11P ANTIQUÉ BRONZE	15 SATIN NICKEL	15A ANTIQUÉ NICKEL	19 MATTE BLACK	26 POLISHED CHROME	26D SATIN CHROME	3 POLISHED BRASS	32D SATIN S.STEEL	4 SATIN BRASS	5 ANTIQUÉ BRASS	/CASE†
LIVIA	L			●	●	●		●					24
NERO	N			●		●		●					24
CASSIUS (HANDED)	Q			●		●		●					24

OTHER FINISHES/OPTIONS AVAILABLE, MINIMUM ORDER QUANTITIES AND/OR ADDITIONAL DELIVERY TIMES MAY BE REQUIRED – PLEASE CONTACT

(†) DUMMY ARE 30/CASE

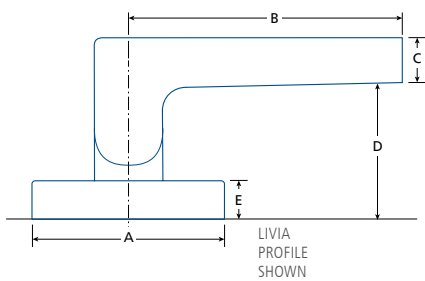

	A	B	C	D	E
LIVIA L / LS	∅ 2 ⁹ / ₁₆ ∅ (65)	3 ⁷ / ₈ (99.8)	3 ³ / ₄ (19.5)	1 ⁵ / ₈ (41)	1 ⁷ / ₃₂ (13.5)
NERO N / NS	∅ 2 ⁹ / ₁₆ ∅ (65)	4 ¹ / ₁₆ (103)	3 ³ / ₈ (9.5)	2 (50.5)	1 ⁷ / ₃₂ (13.5)
CASSIUS Q	∅ 2 ⁹ / ₁₆ (65)	4 ⁵ / ₈ (117)	2 ⁹ / ₃₂ (23)	1 ¹¹ / ₁₆ (43.4)	1 ⁷ / ₃₂ (13.5)

IN (MM)

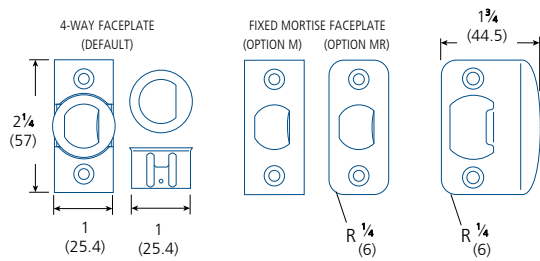

Knobs

- Mid-century inspired, contemporary door knobs that can accommodate nearly any modern decor
- Privacy function with auto-release
- Keyed entry function available
- Round or square rose

- 1 year mechanical warranty
- 1 year limited finish warranty

- Non-handed, zinc die-cast knob
- For doors $1\frac{3}{8}$ – $1\frac{3}{4}$ " (35–44.5 mm) thick
- Fits standard $2\frac{1}{8}$ " (54 mm) door preparation with 1" (25.4 mm) edge bore
- Steel tubular spring latch with adjustable $2\frac{3}{8}$ – $2\frac{3}{4}$ " (60–70 mm) backset
- 4-Way, mortise faceplate with square corners, convertible to drive-in
- Entry model includes 5-pin cylinder, Weiser keyway with 2 keys
- Full-lip strike with round corners included
- Other faceplate options available

AVAILABLE FUNCTIONS

- 10 Passage
- 42 Privacy, with auto-release
- 51 Entry 
- 17 Single Dummy (surface)



ROSE

GEMINI
SATIN NICKEL

15 19



ROSE

GEMINI
SATIN NICKEL

15 19

SELECTION GUIDE

V3X	42	G	S	-	15	MR
SERIES	FUNCTION	STYLE	ROSE ¹		FINISH	LATCH ²

(1) LEAVE BLANK FOR ROUND ROSE (2) 4-WAY LATCH BY DEFAULT; **MR**: FIXED MORTISE (RND)

	10B OIL RUB. BRONZE	11P ANTIQU BRONZE	15 SATIN NICKEL	15A ANTIQU NICKEL	19 MATTE BLACK	26D SATIN CHROME	3 POLISHED BRASS	4 SATIN BRASS	5 ANTIQU BRASS	53 ANT. / POL. BRASS	/CASE†
GEMINI	G/GS		●		●						24*

OTHER FINISHES AVAILABLE, MINIMUM ORDER QUANTITIES AND/OR ADDITIONAL DELIVERY TIMES MAY BE REQUIRED – PLEASE CONTACT
 (†) DUMMY ARE 30/CASE (*) GEMINI ENTRY FUNCTION IS 12/CASE

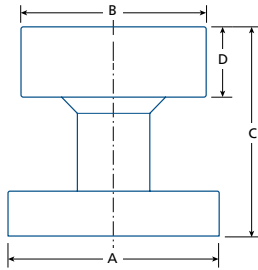

	A	B	C	D
GEMINI	∅ 2 ⁹ / ₁₆	2 ¹ / ₄	2 ⁹ / ₁₆	7 ⁷ / ₈
G/GS	∅ (65)	(57)	(65)	(22)

IN (MM)

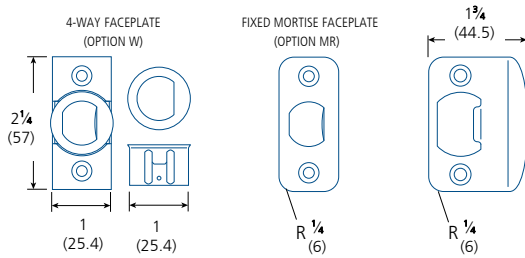

Deadbolt Locks

- Contemporary deadbolt lock styles for home and property security



METRO SQUARE
MATTE BLACK
SINGLE CYLINDER



- 20 Minute fire-rating model available
- 1 year mechanical warranty
- 1 year limited finish warranty
- For doors 1 $\frac{3}{8}$ –1 $\frac{3}{4}$ " (35–44.5 mm) thick
- Extension kit for 2 $\frac{1}{4}$ " (57 mm) thick doors available (#B1-EXT)
- Fits standard 2 $\frac{1}{8}$ " (54 mm) door preparation with 1" (25.4 mm) edge bore
- Steel 1" (25.4 mm) deadbolt latch with hardened steel security pin and adjustable 2 $\frac{3}{8}$ –2 $\frac{3}{4}$ " (60–70 mm) backset
- Mortise faceplate with square corners, convertible to drive-in
- 5-pin cylinder, Weiser keyway with 2 keys
- Strike for wood door frames included
- Other faceplate options available
- 5-pin Schlage cylinder available

AVAILABLE FUNCTIONS

- 51 Single cylinder with thumb-turn ➔

SELECTION GUIDE

V11	51	-	S	-	15	KD	M
SERIES ¹	FUNCTION	STYLE ²	FINISH	KEYING ³	LATCH ⁴		

(1) **V11**: WEISER 5-PIN; **V12**: SCHLAGE 5-PIN. (2) **S**: SQUARE (3) **KA**: KEYED ALIKE **KD**: KEYED DIFFERENT (4) **M**: CONVERTIBLE MORTISE **FM**: FIRE-RATED, FIXED MORTISE (SQ CORNER)



For fire labelled wood doors ONLY. To order, specify V12 Schlage series lock with FM latch.

STYLE	10B OIL RUB. BRONZE	11P ANTIQUÉ BRONZE	15 SATIN NICKEL	15A ANTIQUÉ NICKEL	19 MATTE BLACK	26 POLISHED CHROME	26D SATIN CHROME	3 POLISHED BRASS	32D SATIN S.STEEL	4 SATIN BRASS	5 ANTIQUÉ BRASS	53 ANT. / POL. BRASS	/CASE
METRO SQUARE			•		•		•						24

OTHER FINISHES AVAILABLE, MINIMUM ORDER QUANTITIES AND/OR ADDITIONAL DELIVERY TIMES MAY BE REQUIRED – PLEASE CONTACT

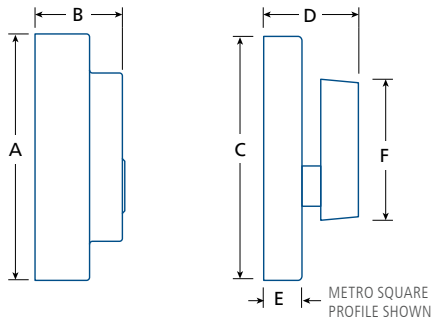

	A	B	C	D	E	F
METRO SQUARE	2 ⁹ / ₁₆ (65)	3/ ₄ (20)	2 ¹ / ₂ (63)	1 ⁹ / ₆₄ (29)	3/ ₈ (9)	1 ³ / ₄ (44.5)
IN (MM)						

CONVERTIBLE FACEPLATE
(OPTION M)

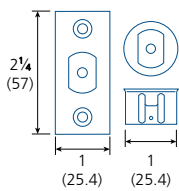

FIXED FACEPLATE
(OPTION FM)

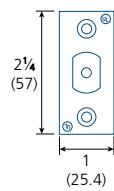

STRIKE

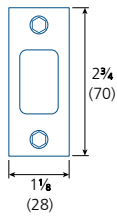

DOREX[®]

BUILDER



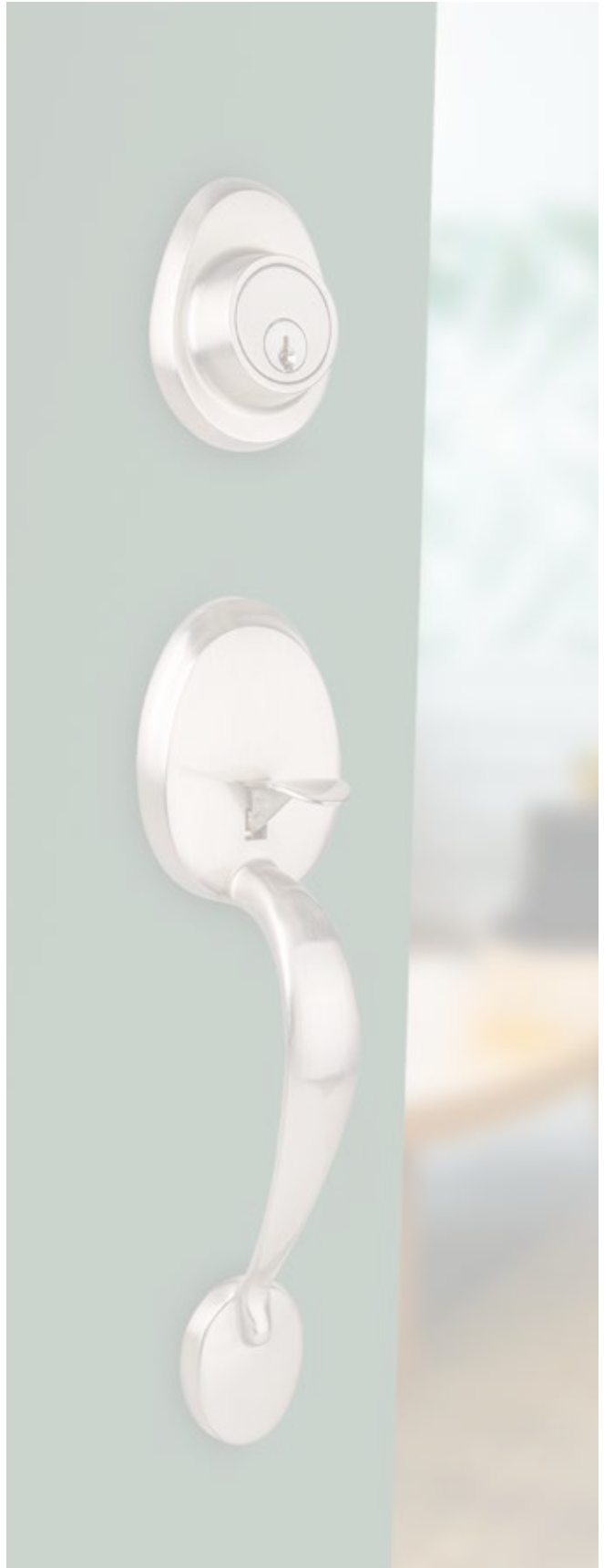

Levers

- Contemporary lever styles for residential home construction professionals
- Keyed entry function available

- 1 Year mechanical warranty
- 1 Year limited finish warranty
- Non-handed zinc die-cast lever
- For doors 1 $\frac{3}{8}$ –1 $\frac{3}{4}$ " (35–44.5 mm) thick
- Fits standard 2 $\frac{1}{8}$ " (54 mm) door preparation with 1" (25.4 mm) edge bore
- Steel tubular spring latch with adjustable 2 $\frac{3}{8}$ –2 $\frac{3}{4}$ " (60–70 mm) backset
- 4-Way, mortise faceplate with square corners, convertible to drive-in
- Entry model includes 5-pin cylinder, Weiser keyway with 2 keys
- Full-lip strike with round corners included
- Other faceplate options available

AVAILABLE FUNCTIONS

- 10 Passage
- 17 Dummy, single (surface)
- 42 Privacy
- 51 Entry ↔



EARL
SATIN NICKEL



STRAIGHT
MATTE BLACK

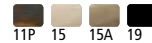

JULIA
SATIN NICKEL



ROSE



SELECTION GUIDE

B2X	42	J	S	-	15	KD	M
SERIES	FUNCTION	STYLE	ROSE ²		FINISH	KEYING ³	LATCH ⁴

(2) BLANK: ROUND; S: SQUARE (3) KD: KEYED DIFFERENT (DEFAULT); KA: KEYED ALIKE
 (4) BLANK: 4-WAY; M: FIXED MORTISE (SQ CORNER); MR: FIXED MORTISE (RND CORNER)

NOTE: ONLY THE STRAIGHT STYLE (S) IS AVAILABLE WITH KEYED ENTRY FUNCTION (S1).

		10B OIL RUB. BRONZE	11P ANTIQU BRONZE	15 SATIN NICKEL	15A ANTIQU NICKEL	19 MATTE BLACK	26 POLISH CHROME	26D SATIN CHROME	3 POLISH BRASS	32D SATIN S.STEEL	4 SATIN BRASS	5 ANTIQU BRASS	/CASE†
EARL	E			●				●					20
JULIA	J			●		●							20
STRAIGHT	S		●	●	●	●		●	●				20

OTHER FINISHES/OPTIONS AVAILABLE, MINIMUM ORDER QUANTITIES AND/OR ADDITIONAL DELIVERY TIMES MAY BE REQUIRED – PLEASE CONTACT

(†) DUMMY ARE 30/CASE

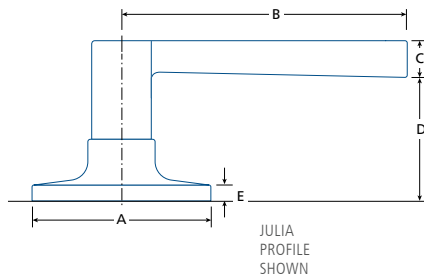

	A	B	C	D	E
EARL E	∅ 2 ⁹ / ₁₆ (65)	3 ¹ / ₂ (89)	3 ³ / ₈ (9.5)	1 ³ / ₈ (35)	1 ⁷ / ₃₂ (13.5)
JULIA J / JS	∅ 2 ⁹ / ₁₆ (65)	4 ⁷ / ₁₆ (112.5)	3 ³ / ₄ (19)	1 ¹ / ₂ (38)	1 ¹ / ₄ (6.5)
STRAIGHT S	∅ 2 ⁹ / ₁₆ (65)	3 ³ / ₄ (95.3)	3 ³ / ₁₆ (4.8)	2 (50.7)	1 ¹ / ₄ (6.5)

IN (MM)

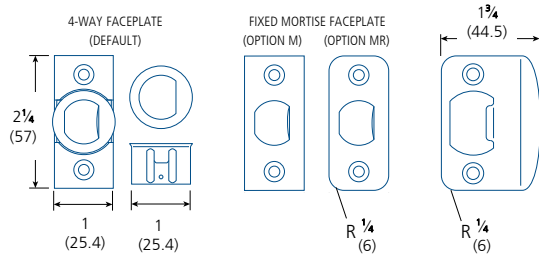

Knobs

- Versatile classic door knobs for residential home construction professionals
- Keyed entry function available

- 1 Year mechanical warranty
- 1 Year limited finish warranty
- Non handed, steel knob
- For doors $1\frac{3}{8}$ – $1\frac{3}{4}$ " (35–44.5 mm) thick
- Fits standard $2\frac{1}{8}$ " (54 mm) door preparation with 1 (25.4 mm) edge bore
- Steel tubular spring latch with adjustable $2\frac{3}{8}$ – $2\frac{3}{4}$ " (60–70 mm) backset
- 4-Way, mortise faceplate with square corners, convertible to drive-in
- Entry model includes 5-pin cylinder, Weiser keyway with 2 keys
- Full-lip strike with round corners included
- Other faceplate options available

AVAILABLE FUNCTIONS

- 10 Passage
- 42 Privacy
- 51 Entry
- 17 Single Dummy (surface)



RONDO
SATIN CHROME



RONDO
SATIN CHROME

SELECTION GUIDE

B3X	51	R	-	15	KD	W
SERIES	FUNCTION	STYLE	FINISH	KEYING ¹	LATCH ²	

(1) **KD**: KEYED DIFFERENT; **KA**: KEYED ALIKE

(2) **W**: 4-WAY; **M**: FIXED MORTISE; **MR**: FIXED MORTISE (RND CORNER)

		10B OIL RUB. BRONZE	11P ANTIQUE BRONZE	15 SATIN NICKEL	15A ANTIQUE NICKEL	19 MATTE BLACK	26D SATIN CHROME	3 POLISHED BRASS	4 SATIN BRASS	5 ANTIQUE BRASS	53 ANT. / POL. BRASS	/CASE†
RONDO	R		●	●	●	●	●	●			●	30

OTHER FINISHES AVAILABLE, MINIMUM ORDER QUANTITIES AND/OR ADDITIONAL DELIVERY TIMES MAY BE REQUIRED – PLEASE CONTACT

(†) DUMMY ARE 60/CASE

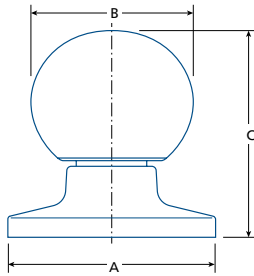

	$\varnothing A$	B	C
RONDO	$2\frac{9}{16}$	2	$2\frac{3}{4}$
R	(65)	(51)	(70)

IN (MM)

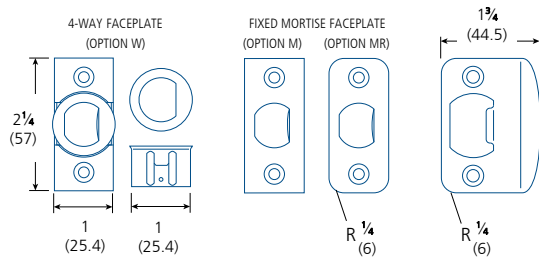

Entry Handlesets

- Classic entry handlesets for residential home construction professionals
- Non-handed
- Includes interior knob

- 1 Year mechanical warranty
- 1 Year limited finish warranty

- Non-handed, zinc die-cast exterior trim
- For doors $1\frac{3}{8}$ – $1\frac{3}{4}$ " (35–44.5 mm) thick
- Fits standard $2\frac{1}{8}$ " (54 mm) door preparation with 1" (25.4 mm) edge bore
- Stainless steel tubular spring latch with adjustable $2\frac{3}{8}$ – $2\frac{3}{4}$ " (60–70 mm) backset
- Steel 1" (25.4 mm) deadbolt latch with hardened steel security pin and adjustable $2\frac{3}{8}$ – $2\frac{3}{4}$ " (60–70 mm) backset
- Mortised faceplate with square corners, convertible to drive-in
- 5-pin cylinder, Weiser keyway with 2 keys
- Full-lip strike and security strike for wood door frames (round corners) included

AVAILABLE FUNCTIONS

- Entry ↔



SELECTION GUIDE

30	1	CH	B	15	KD	W
SERIES	KEYWAY ¹	STYLE	TRIM	FINISH	KEYING ²	LATCH ³

(1) 1: WEISER (2) KD: KEYED DIFFERENT (3) W: MORTISE

		C10B OIL RUB. BRONZE	C11P ANTIQUÉ BRONZE	C15 SATIN NICKEL	C15A ANTIQUÉ NICKEL	C19 MATTE BLACK	C26 POLISHED CHROME	C26D SATIN CHROME	C3 POLISHED BRASS	C32D SATIN S.STEEL	C4 SATIN BRASS	C5 ANTIQUÉ BRASS	V3* POLISHED BRASS	/CASE
CHÂTEAU	CH		•	•	•	•		•						6
LAURENTIAN	LA			•		•								6
MANOR	MN		•	•	•	•		•	•					6

OTHER FINISHES AVAILABLE, MINIMUM ORDER QUANTITIES AND/OR ADDITIONAL DELIVERY TIMES MAY BE REQUIRED – PLEASE CONTACT (*) LIFETIME FINISH WARRANTY

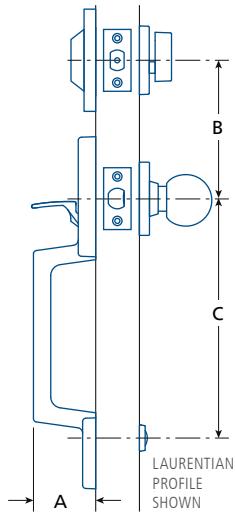

	A	B ¹	C ²
CHÂTEAU CH	2 ⁹ / ₁₆ (65)	5 (127)	8 ⁷ / ₁₆ (214)
LAURENTIAN LA	2 ³ / ₈ (60)	5 (127)	8 ⁷ / ₁₆ ⁽²⁾ (214)
MANOR MN	2 ³ / ₈ (60)	5 (127)	8 ⁵ / ₈ (219)

IN (MM) (1) RECOMMENDED DISTANCE (2) DEFAULT DISTANCE, CAN BE ADJUSTED TO 8 5/8" (219MM) OR 9" (228MM)

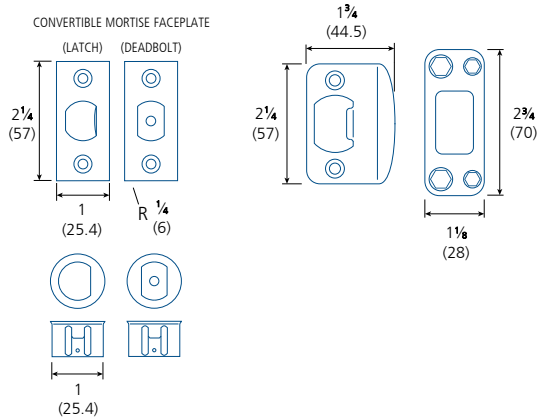

Deadbolt Locks

- Classic deadbolt for home construction professionals

- 1 Year mechanical warranty
- 1 Year limited finish warranty
- For doors $1\frac{3}{8}$ – $1\frac{3}{4}$ " (35–44.5 mm) thick
- Fits standard $2\frac{1}{8}$ " (54 mm) door preparation with 1" (25.4 mm) edge bore
- Steel 1" (25.4 mm) deadbolt latch with hardened steel security pin and adjustable $2\frac{3}{8}$ – $2\frac{3}{4}$ " (60–70 mm) backset
- 4-Way mortise faceplate with square corners, convertible to drive-in
- 5-pin cylinder, Weiser keyway with 2 keys
- Security strike for wood door frames included



CITADELLE (C)
SATIN CHROME
SINGLE CYLINDER



AVAILABLE FUNCTIONS

- 51 Single cylinder with thumb-turn ➔

SELECTION GUIDE

CITADELLE // STANDARD

B1	1	51	C	-	15	KD	M
SERIES	KEYWAY ¹	FUNCTION	TYPE	FINISH	KEYING ²	LATCH ³	

(1) **1:** WEISER **2:** SCHLAGE (2) **KD:** KEYED DIFFERENT (DEFAULT); **KA:** KEYED ALIKE
 (3) **W:** 4-WAY; **M:** FIXED MORTISE; **MR:** FIXED MORTISE (RND CORNER)

STYLE	10B OIL RUB. BRONZE	11P ANTIQUÉ BRONZE	15 SATIN NICKEL	15A ANTIQUÉ NICKEL	19 MATTE BLACK	26 POLISHED CHROME	26D SATIN CHROME	3 POLISHED BRASS	32D SATIN S.STEEL	4 SATIN BRASS	5 ANTIQUÉ BRASS	53 ANT. / POL. BRASS	/CASE
CITADELLE ROUND		•	•		•			•	•		•	•	24

OTHER FINISHES AVAILABLE, MINIMUM ORDER QUANTITIES AND/OR ADDITIONAL DELIVERY TIMES MAY BE REQUIRED – PLEASE CONTACT

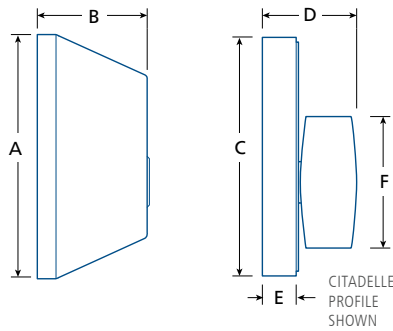

	A	B	C	D	E	F
CITADELLE						
C	∅ 2 ⁹ / ₁₆ (65)	1 ¹ / ₄ (32)	∅ 2 ¹ / ₂ (63)	1 (25.5)	3 ³ / ₈ (9.5)	1 ¹³ / ₃₂ (36)

IN (MM)

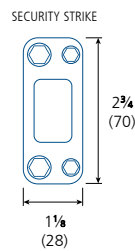
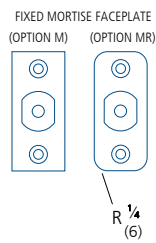
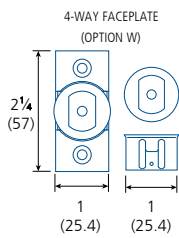

POCKET DOOR

RESIDENTIAL AUXILIARY LOCKS

POCKET DOOR LOCK

2510, 2542



2510C15
PASSAGE



2542C26D
PRIVACY

- Fits doors 1 $\frac{3}{8}$ " (35 mm) thick
- Solid brass construction
- Handed, reversible
- Privacy model includes strike
- Mounting hardware included: wood screws

DIMENSIONS

2 $\frac{1}{4}$ " D x 3 $\frac{1}{4}$ " H x 1 $\frac{3}{8}$ " W (57 x 83 x 35 mm)

MODELS

2510: Passage
2542: Privacy

2510	C15
MODEL	FINISH

C15	C15A	C19	C26	C26D	C3	C5
SATIN NICKEL	ANTIQUÉ NICKEL	MATTE BLACK	POLISHED CHROME	SATIN CHROME	POLISHED BRASS	ANTIQUÉ BRASS

OTHER FINISHES AVAILABLE—PLEASE CONTACT

POCKET DOOR LOCK

2610, 2642



2610-11P
PASSAGE



2642-26D
PRIVACY



2610S-19
PASSAGE



2642S-15
PRIVACY

- Fits doors 1 $\frac{3}{8}$ –1 $\frac{3}{4}$ " (35–44.5 mm) thick with standard 160 or 161 door preparation
- Non-handed
- 2 $\frac{3}{8}$ " (60 mm) backset
- 2 $\frac{3}{4}$ " (70 mm) backset latch sold separately:
#2610L234: Passage
#2642L234: Privacy
- Spring-loaded pop-out edge pull
- Privacy model includes latch with integrated spring-loaded pop-out edge pull, dust box, and strike
- Mounting hardware included: wood screws

DIMENSIONS

Round rose: \varnothing 2 $\frac{7}{16}$ " (62 mm)

Square rose (S): \varnothing 2 $\frac{7}{16}$ " (62 mm)

Faceplate: 1 x 2 $\frac{1}{4}$ " (25.4 x 57 mm);
 $\frac{1}{4}$ " (6.4 mm) radius corners*

(*) Square corner faceplate available by special order.

MODELS

2610: Round, Passage

2642: Round, Privacy

2610S: Square, Passage

2642S: Square, Privacy

2642	-	26D
MODEL		FINISH

2610 / 2642

11P	15	15A	19	26	26D	3
ANTIQUÉ BRONZE	SATIN NICKEL	ANTIQUÉ NICKEL	MATTE BLACK	POLISHED CHROME	SATIN CHROME	POLISHED BRASS

OTHER FINISHES AVAILABLE—PLEASE CONTACT

2610S / 2642S

15	19	26D
SATIN NICKEL	MATTE BLACK	SATIN CHROME

OTHER FINISHES AVAILABLE—PLEASE CONTACT



- Certifications**
- Conforms to ANSI/BHMA A156.5, Grade 2
 - cULus listed, 2hr fire-rating
 - 3 Year limited mechanical warranty
 - 1 Year limited electronic warranty

Door Thickness • 1 $\frac{3}{8}$ –2" (35–51 mm)

Handing • Non handed

Backset • 2 $\frac{3}{8}$ –2 $\frac{3}{4}$ " (60–70 mm) adjustable

Deadbolt • Steel with hardened steel security pin
• 1" (25.4 mm) throw

Faceplate • Mortise type, square corners
• 1 x 2 $\frac{1}{4}$ " (25.4 x 57 mm)

Strike • Security strike (wood frame), square corners
• 1 $\frac{1}{8}$ x 2 $\frac{3}{4}$ " (28.5 x 70 mm)

Chassis • Steel cylinder housing
• Exposed mounting screws
• Exterior rubber gasket

Preparation • Cross bore: 2 $\frac{1}{8}$ " or 1 $\frac{1}{2}$ " (54 or 38 mm)
• Edge bore: 1" (25.4 mm)

Cylinder • Solid brass, 5-pin (drilled 6)
• Schlage "C" keyway, 2 keys
• Removable, rekeyable

Other keyways and keying options available, including CX5 high security.

Interface • Digital touch keypad
• Blue LED back-light

Electronic Features

- 1 Programming code (8 digit)
- 25 User codes (4–8 digits)
- 4 Renewable single use codes
- Auto Lock with delay (99 sec. maximum)
- Vacation Mode (disables keypad)
- Optional random screen keypad activation code to prevent number probing
- Low battery power indicator

Wireless Protocol

- RFID - MIFARE™ 13.56 MHz (Classic 1K)
- 25 RFID token capacity
- 2 RFID cards included*
- Two-factor authentication mode available (requires user code and RFID token)

(Other single or dual frequency key fobs and bracelets available by special order.*

Power • DC 6V

Four (4) AA 1.5V alkaline batteries NOT included

Operation Temperature • -31° to 150.8°F (-35° to 66°C)
Temperature tolerance can vary due to weather conditions

Function 51 Single cylinder, thumb-turn

Finish 15–Satin nickel, 19–Matte black

Other finishes available by special order

ASM	-	F400T	-	NR	-	2		51		KD		M	-	15
TYPE		SERIES		PROTOCOL		KEYWAY		FUNCTION		KEYING		LATCH		FINISH

SELECTION GUIDE

SERIES	DESCRIPTION	FINISH ¹	/CASE
ASM-F400T-NR	RFID Electronic deadbolt with LED digital touch keypad. 	15, 19	6

(1) OTHER FINISHES AVAILABLE, MINIMUM ORDER QUANTITIES AND/OR ADDITIONAL DELIVERY TIMES MAY BE REQUIRED
 KEYED FUNCTION; FULL KEYING SERVICES AVAILABLE

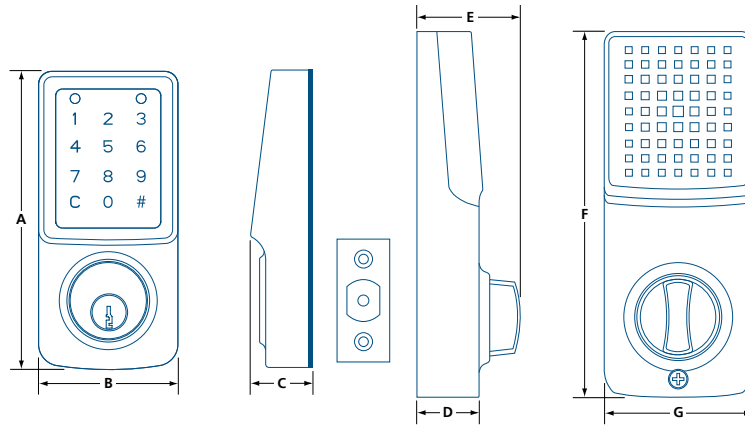

	A	B	C	D	E	F	G
F400T	5 ⁷ / ₁₆ (138)	2 ¹ / ₂ (65)	1 ¹ / ₈ (29)	1 ¹ / ₈ (30)	2 (51.5)	6 ¹³ / ₁₆ (173)	2 ³ / ₄ (70)

IN (MM)

PARTS & ACCESSORIES



A-F400-PBC
Replacement battery cover for F400T.



A-F4-PDW
11 in (28 cm) data wire.



A-PDMF-BU
Single frequency RFID (13.56 MHz),
Classic 1K key fob.



A-F400-PIG
Optional rubber gasket for interior trim
for F400T. *Not included.*





- Certifications**
- Conforms to ANSI/BHMA A156.2, Grade 2
 - 3 Year limited mechanical warranty
 - 1 Year limited electronic warranty
- Door Thickness**
- 1 3/8"–2" (35–51 mm)
- Handing**
- Non handed
- Backset**
- 2 3/8"–2 3/4" (60–70 mm) adjustable
- Spring Latch**
- Zinc alloy
 - 1/2" (12.7 mm) throw
- Faceplate**
- Mortise type, square corners
 - 1 x 2 1/4" (25.4 x 57 mm)
- Strike**
- T-Type, square corners
 - 1 1/8 x 2 3/4" (28.5 x 70 mm) wood frame
- Chassis**
- Zinc die-cast levers
 - Lever clutch release
 - Exposed mounting screws
 - Interior / exterior trim gaskets
- Preparation**
- Cross bore: 2 1/8" (54 mm)
 - Edge bore: 1" (25.4 mm)
- Cylinder**
- Solid brass, 5-pin
 - Schlage "C" keyway, 2 keys
 - Removable, rekeyable
- Other keyways and keying options available. May require special order.*
- Interface**
- Digital touch keypad
 - Blue LED back-light

- Electronic Features**
- 1 Programming code (8 digit)
 - 25 User codes (4–8 digits)
 - 4 Renewable single use codes
 - Auto Lock with delay (99 sec. maximum)
 - Vacation Mode (disables keypad)
 - Optional random screen keypad activation code to prevent number probing
 - Low battery power indicator
- Wireless Protocol**
- RFID - MIFARE™ 13.56 MHz (Classic 1K)
 - 25 RFID token capacity
 - 2 RFID cards included*
 - Two-factor authentication mode available (requires user code and RFID token)
- (* Other single or dual frequency key fobs and bracelets available by special order.)*
- Power**
- DC 6V
- Four (4) AA 1.5V alkaline batteries NOT included.*
- Operation Temperature**
- -31° to 150.8°F (-35° to 66°C)
- Temperature tolerance can vary due to weather conditions.*
- Function**
- 80 Storeroom
- Lever Style**
- JN–Juno (default), C–Curved return*, H–Standard return*
- (* May require additional lead time.)*
- Finish**
- 15–Satin nickel, 19–Matte black
- Other finishes available by special order.*

ASM	-	F425T	-	NR	-	2		80		KD		M	-	JN	-	15
TYPE		SERIES		PROTOCOL		KEYWAY		FUNCTION		KEYING		LATCH		LEVER		FINISH

SELECTION GUIDE

SERIES	DESCRIPTION	STYLE ¹	FINISH ²	/ CASE
ASM-F425T-NR	RFID Electronic lever lockset with LED digital touch keypad. 	JN, C, H	15, 19	4

(1) OPTIONAL C, H STYLE LEVERS MAY REQUIRE ADDITIONAL LEAD TIME (2) OTHER FINISHES AVAILABLE, MINIMUM ORDER QUANTITIES AND/OR ADDITIONAL DELIVERY TIMES MAY BE REQUIRED.
 KEYED FUNCTION; FULL KEYING SERVICES AVAILABLE.

OPTIONAL LEVERS



(C) Curved return



(H) Standard return

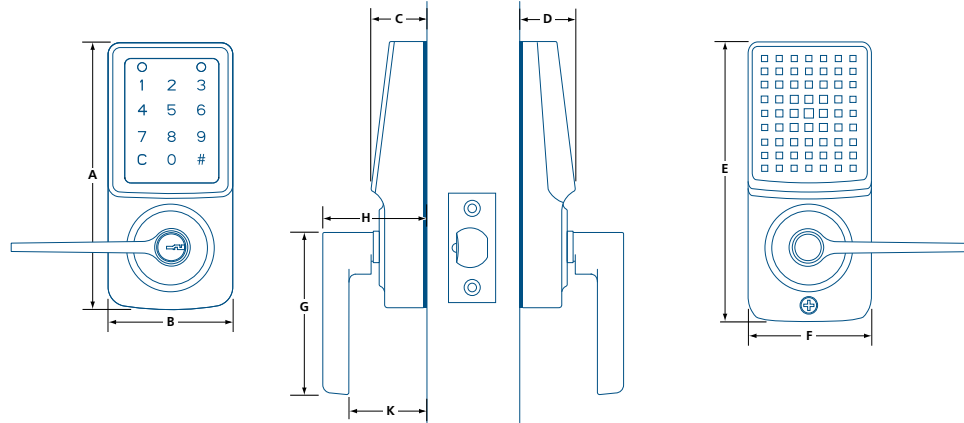

	A	B	C	D	E	F	G	H	K
F425T JN (JUNO)	6 ¹ / ₈ (155)	3 (76)	1 ¹¹ / ₃₂ (34)	1 ¹ / ₄ (32)	6 ¹ / ₈ (155)	2 ²⁹ / ₃₂ (74)	4 ²⁵ / ₃₂ (121.2)	2 ²⁷ / ₃₂ (72.5)	2 (50.8)

IN (MM)

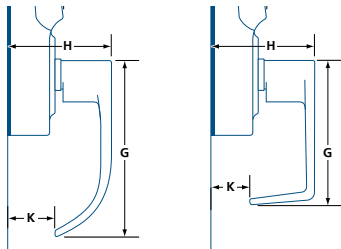

	G	H	K
F425T C	4 ¹¹ / ₁₆ (118.9)	2 ²⁷ / ₃₂ (72.5)	1 ³ / ₃₂ (27.7)
F425T H	4 ³ / ₁₆ (106.2)	2 ²⁷ / ₃₂ (72.5)	1 (25.6)

IN (MM)

PARTS & ACCESSORIES



A-F425-PBC

Replacement battery cover for F425T.



A-F425-PST

Replacement screen trim for F425T.



A-PDMF-BU

Single frequency RFID (13.56MHz),
Classic 1K key fob.





- Certifications**
- Conforms to ANSI/BHMA A156.5, Grade 2
 - cULus listed, 20min fire-rating
 - UL 1043, Safety for Burglary-Resistant Electric Locking Mechanisms
 - 3 Year limited mechanical warranty
 - 1 Year limited electronic warranty
- Door Thickness**
- 1³/₈–2" (35–51 mm)
- Handing**
- Non handed
- Backset**
- 2³/₈–2³/₄" (60–70 mm) adjustable
- Deadbolt**
- Steel with hardened steel security pin
 - 1" (25.4 mm) throw
- Faceplate**
- Mortise type, square corners
 - 1 x 2¹/₄" (25.4 x 57 mm)
- Strike**
- Security strike (wood frame), square corners
 - 1¹/₈ x 2³/₄" (28.5 x 70 mm)
- Chassis**
- Steel cylinder housing
 - Exposed mounting screws
 - Integrated all-weather seal
- Preparation**
- Cross bore: 2¹/₈" or 1¹/₂" (54 or 38 mm)
 - Edge bore: 1" (25.4 mm)
- Cylinder**
- Solid brass, 5-pin (drilled 6)
 - Schlage "C" keyway, 2 keys
 - Removable, rekeyable
- Other keyways and keying options available, including CX5 high security.*

- Interface**
- Digital touch keypad
 - White LED back-light
- Electronic Features**
- iKey Connect mobile app control (iOS / Android)
 - 200 User credentials per lock
 - PIN codes can be single use, scheduled, or permanent
 - Optional keyless entry (geofencing)
 - Optional auto-lock with delay (900 sec. max.)
 - Optional random keypad activation code to prevent number probing
 - Vacation mode (disables keypad)
 - Audit trail (accessible via app)
 - Low battery power indicator (in-app / on-device)
 - Multi-lock management*

() Local touring, lock-to-phone management, see instructions for details.*

- Protocol**
- BLE Pairing (128-bit encryption)
- Operation**
- -31° to 150.8°F (-35° to 66°C)
- Temperature**
- *Temperature tolerance can vary due to weather.*
- Power**
- DC 6V
 - *Four (4) AA 1.5V alkaline batteries NOT included*
- Function**
- 51 Single cylinder, thumb-turn
- Finish**
- 15–Satin nickel, 19–Matte black
 - *Other finishes available by special order*

AMM	-	F500T	-	NB	-	2		51		KD		M	-	15
TYPE		SERIES		PROTOCOL		KEYWAY		FUNCTION		KEYING		LATCH		FINISH



SELECTION GUIDE

SERIES	DESCRIPTION	FINISH ¹	/CASE
AMM-F500T-NB	Smart BLE Electronic deadbolt with LED digital touch keypad. 	15, 19	6

(1) OTHER FINISHES AVAILABLE, MINIMUM ORDER QUANTITIES AND/OR ADDITIONAL DELIVERY TIMES MAY BE REQUIRED
 KEYED FUNCTION; FULL KEYING SERVICES AVAILABLE

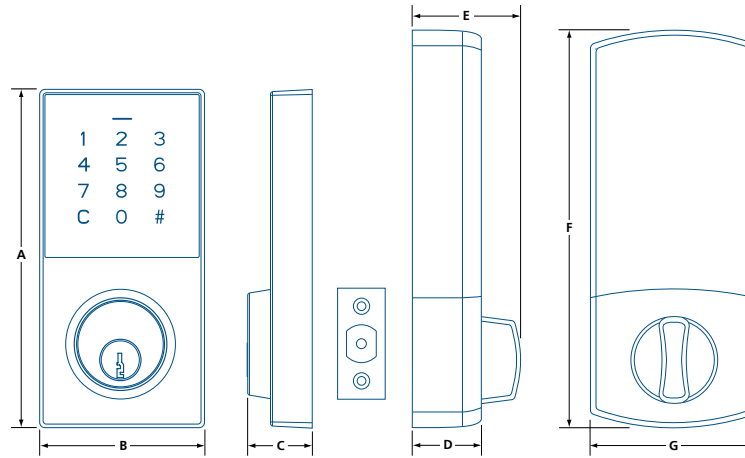

	A	B	C	D	E	F	G
F500T	5 ³ / ₈ (136)	2 ⁵ / ₈ (66)	1 (26)	1 ¹ / ₈ (28)	1 ³ / ₄ (44)	6 ⁵ / ₁₆ (160)	2 ⁵ / ₈ (67)

IN (MM)

PARTS & ACCESSORIES



A-F4-PDW
 11 in (28 cm) data wire.



ER SERIES

ELECTRONIC DEADBOLT



1
YEAR



REMOTE CONTROL
INCLUDED

- Certifications** • 1 Year limited warranty
- Door Thickness** • 1 $\frac{3}{8}$ –2" (35–51 mm)
- Handing** • Non handed
- Backset** • 2 $\frac{3}{8}$ –2 $\frac{3}{4}$ " (60–70 mm), adjustable
- Deadbolt** • Steel bolt with hardened steel security pin
• 1" (25.4 mm) throw
- Faceplate** • Mortise type, square corner
• 1 $\frac{1}{8}$ x2 $\frac{1}{4}$ " (29x57 mm)
- Strike** • 1 $\frac{1}{8}$ x2 $\frac{3}{4}$ " (29x70 mm) wood frame
- Preparation** • Cross bore: 2 $\frac{1}{8}$ " (54 mm)
• Edge bore: 1" (25.4 mm)
See installation instructions for details
- Cylinder** • 5-pin, removable cylinder
• Weiser keyway, 2 keys
Other keyways and keying options available

- Electronic Features** • Battery powered*, low battery indicator
• LED illuminated keyboard
• Fully programmable from keyboard, no computer required
• For up to 6 users (4 to 10 digit code)
• Settings saved in memory
• Visual and audio confirmation and notifications
• Remote control (98 ft/30 m range) included
• Auto-locking function available
() Four (4) AA batteries not included*

- Operating Temperature** • -4° to 185°F (-20° to 85°C)
• 30 to 90% humidity

Rubber gaskets prevent water penetration

- Functions** 51 Single cylinder, thumbturn

- Styles** ER–Traditional body, SER–Contemporary body

- Finish** 11P–Antique bronze, 15–Satin nickel,
15A–Antique nickel, 19–Matte black,
26D–Satin chrome, V3–Polished brass (lifetime)

Other finishes available by special order

201	51	SER	26D	KD	U
SERIES	FUNCTION	STYLE	FINISH	KEYING	LATCH ¹

(1) U–UNIVERSAL LATCH, CONVERTS TO DRIVE-IN

SELECTION GUIDE

MODEL	DESCRIPTION	FINISH
201 51 ER	Electronic deadbolt with LED keypad & remote, traditional style. ➤	11P, 15, 15A, 19, 26D, V3
201 51 SER	Electronic deadbolt with LED keypad & remote, contemporary style. ➤	15, 15A, 19, 26D

OTHER FINISHES AVAILABLE, MINIMUM ORDER QUANTITIES AND/OR ADDITIONAL DELIVERY TIMES MAY BE REQUIRED
 ➤ KEYED FUNCTION; FULL KEYING SERVICES AVAILABLE

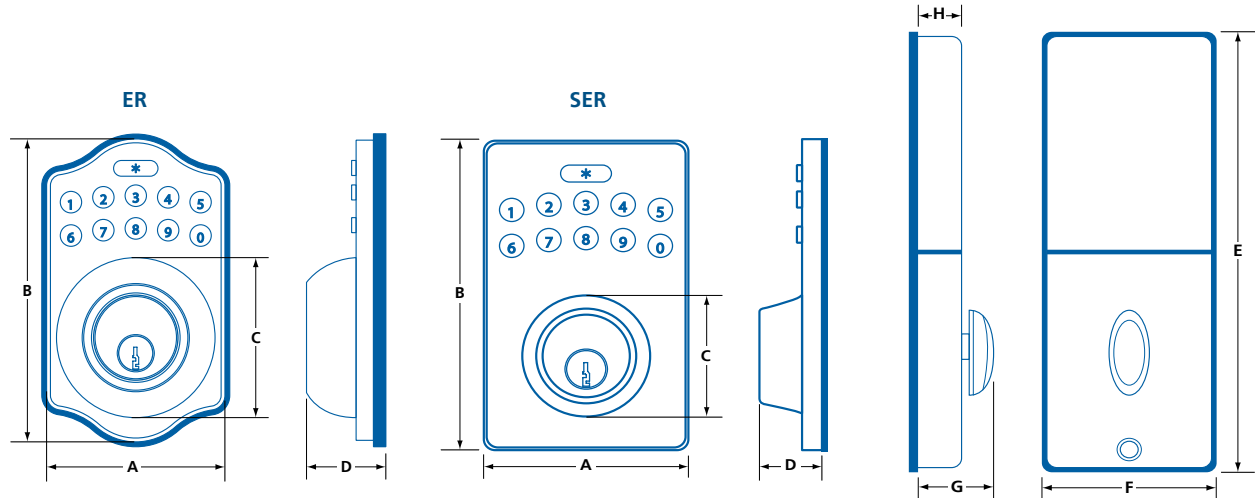

	A	B	C	D	E	F	G	H
ER	27/8 (73)	47/8 (124)	29/16 (65)	13/8 (35)	7 1/4 (184)	2 11/16 (68)	1 3/4 (44)	1 1/16 (27)
SER	3 (76)	49/16 (116)	1 15/16 (49)	1 1/8 (29)	7 1/4 (184)	2 11/16 (68)	1 3/4 (44)	1 1/16 (27)

IN (MM)

PARTS & ACCESSORIES



200ERC

Additional remote control with override key.
 Battery included.



- Reliable, quality, and convenient modern electronic entry handleset for residential homes
- Includes F500 smart electronic deadbolt, classic interior lever and exterior handle
- Control and configure your lock using the intuitive iKey mobile application. Grant access to family, guests or service providers with a simple tap on your device. Available for both iOS and Android smartphones.



- Deadbolt conforms to ANSH/BHMA Grade 2
- UL 1034, Safety for Burglary-Resistant Electric Locking Mechanisms
- 3-year limited mechanical warranty
- 1-year limited finish warranty
- 1-year limited electronic warranty
- Non-handed, zinc die-cast exterior trim
- For doors 1¾–2¼" (44.5–57 mm) thick
- Fits standard 2½" (54 mm) door preparation with 1" (25.4 mm) edge bore
- Steel tubular spring latch with adjustable 2¾–2¾" (60–70 mm) backset.
- Steel 1" (25.4 mm) deadbolt latch with hardened steel security pin and adjustable 2¾–2¾" (60–70 mm) backset
- Mortised faceplate with square corners, convertible to drive-in
- Integrated all-weather seal for outdoor use
- Deadbolt operated by touchscreen or key
- 5-pin brass cylinder in steel housing with 2 keys
- Full-lip strike and 2-piece deadbolt strike and dustbox included
- Handle with adjustable mounting post
- Requires 4 AA batteries (not included)

ELECTRONIC FEATURES

- Digital touchscreen, blue LED backlight
- 200 User credentials per lock
- PIN Codes can be single use, scheduled, or permanent
- Optional keyless entry (geofencing)
- Optional auto-lock with delay (900 sec. max.)
- Optional random keypad activation code to prevent number probing
- Vacation mode (disables keypad)
- Audit trail (accessible via app)
- Low battery power indicator (in-app / on-device)
- Multi-lock management* – manage multiple F500 locks with one app

(* Local touring, lock-to-phone management, see instructions for details.



SATIN NICKEL



SELECTION GUIDE

F500T	-	NB	-	LAS	-	1	51	KD	M	-	15	
SERIES	PROTOCOL	STYLE ¹	KEYWAY ²	FUNCTION	KEYING	LATCH	FINISH					

(1) LAS: LEVER WITH ROUND ROSE (2) 1: SCHLAGE; 2: WEISER

	10B	11P	15	15A	19	26	26D	3	32D	4	C5	V3*	/CASE
	OIL RUB. BRONZE	ANTIQU BRONZE	SATIN NICKEL	ANTIQU NICKEL	MATTE BLACK	POLISHED CHROME	SATIN CHROME	POLISHED BRASS	SATIN S.STEEL	SATIN BRASS	ANTIQU BRASS	POLISHED BRASS	
T500 COMBO	LAS		●		●								6

OTHER FINISHES AVAILABLE, MINIMUM ORDER QUANTITIES AND/OR ADDITIONAL DELIVERY TIMES MAY BE REQUIRED – PLEASE CONTACT (*) LIFETIME FINISH WARRANTY

DIMENSIONS

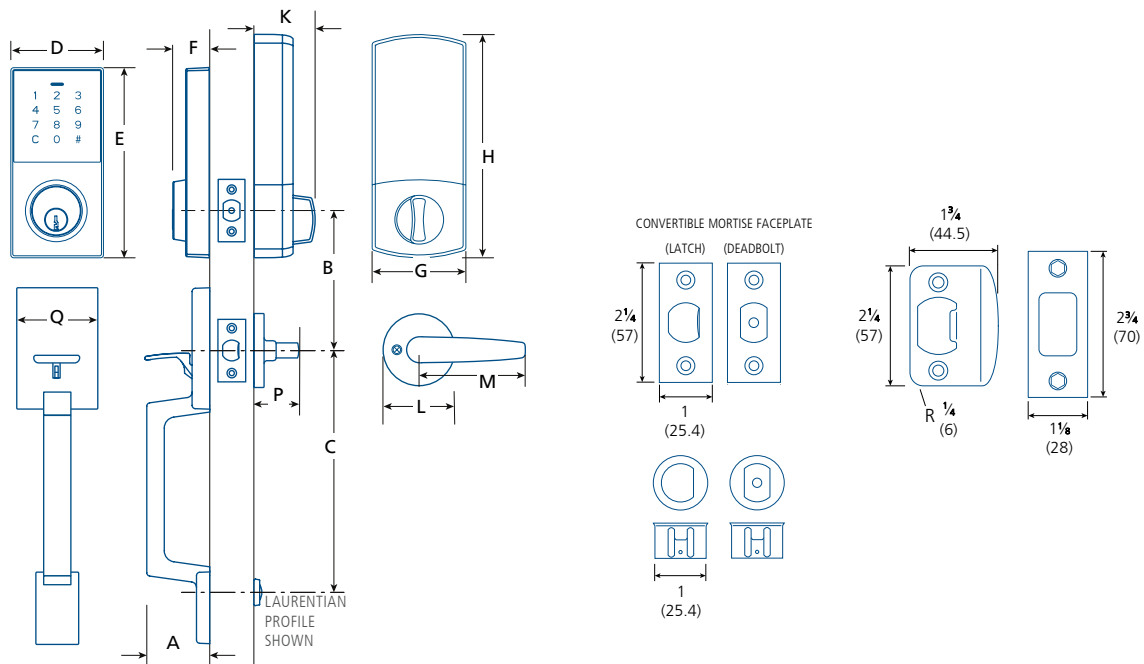

	A	B ¹	C	D	E	F	G	H	K	L	M	P	Q
T500 COMBO	2¼	5	87/16 (214)	23/8	5½	1	25/8	65/16	1¾	29/16	3½	2	23/16
LAS	(54)	(127)	85/8 (219) ²	(60)	(139)	(26)	(67)	(160)	(44)	(65)	(88.9)	(50.8)	(62)
			830/32 (228)										

IN (MM) (1) RECOMMENDED DISTANCE (2) DEFAULT MOUNTING DISTANCE



- Reliable and convenient modern electronic entry handleset for residential single family homes
- Concealed mounting screws
- Includes T300 electronic deadbolt, Linea interior lever and Delta exterior handle
- Interior lever can be swapped with any other Tecnica Design lever¹
- Available with round or square interior trim

(1) Availability may vary, please contact your local Dorex representative.

- 3-year limited mechanical warranty
- 5-year limited finish warranty
- 1-year limited electronic warranty
- Non-handed, zinc die-cast exterior trim
- For doors 1 $\frac{3}{4}$ –2 $\frac{1}{4}$ " (44.5–57 mm) thick
- Fits standard 2 $\frac{1}{8}$ " (54 mm) door preparation with 1" (25.4 mm) edge bore
- Steel tubular spring latch with adjustable 2 $\frac{3}{8}$ –2 $\frac{3}{4}$ " (60–70 mm) backset.
- Steel 1" (25.4 mm) deadbolt latch with hardened steel security pin and adjustable 2 $\frac{3}{8}$ –2 $\frac{3}{4}$ " (60–70 mm) backset
- Mortised faceplate with square corners, convertible to drive-in
- Galvanized steel interior mechanism
- Temperature: -20° to 60°C (-4° to 140°F)
- Weiser 5-pin brass cylinder in steel housing with 2 keys
- Full-lip strike and deadbolt security strike for wood door frames included

ELECTRONIC FEATURES

- Deadbolt operated by touchscreen keypad or key
- Can handle up to 70 user codes, and 5 renewable single-use codes
- Proximity sensor lights keypad when approached
- Anti-fingerprint surface prevents code guessing
- Touchscreen keypad stays lit for 30 seconds after activity
- Automatic locking for peace of mind
- Vacation mode deactivates the keypad while away
- Low battery indicator (audible and visible)
- Requires four (4) 1.5v AA batteries (not included)



SELECTION GUIDE

T300T	- N	- DT	LTS	- 1	51	KD	M	- 15
SERIES	PROTOCOL	STYLE	TRIM ⁽¹⁾	KEYWAY	FUNCTION	KEYING	LATCH	FINISH
(1) LTS: LINEA SQUARE LT: LINEA ROUND								

	10B	11P	15	15A	19	26	26D	3	32D	4	C5	V3*	/CASE
	OIL RUB. BRONZE	ANTIQU BRONZE	SATIN NICKEL	ANTIQU NICKEL	MATTE BLACK	POLISHED CHROME	SATIN CHROME	POLISHED BRASS	SATIN S.STEEL	SATIN BRASS	ANTIQU BRASS	POLISHED BRASS	
T300 COMBO	DT		●		●								6

OTHER FINISHES AVAILABLE, MINIMUM ORDER QUANTITIES AND/OR ADDITIONAL DELIVERY TIMES MAY BE REQUIRED – PLEASE CONTACT (*) LIFETIME FINISH WARRANTY

DIMENSIONS

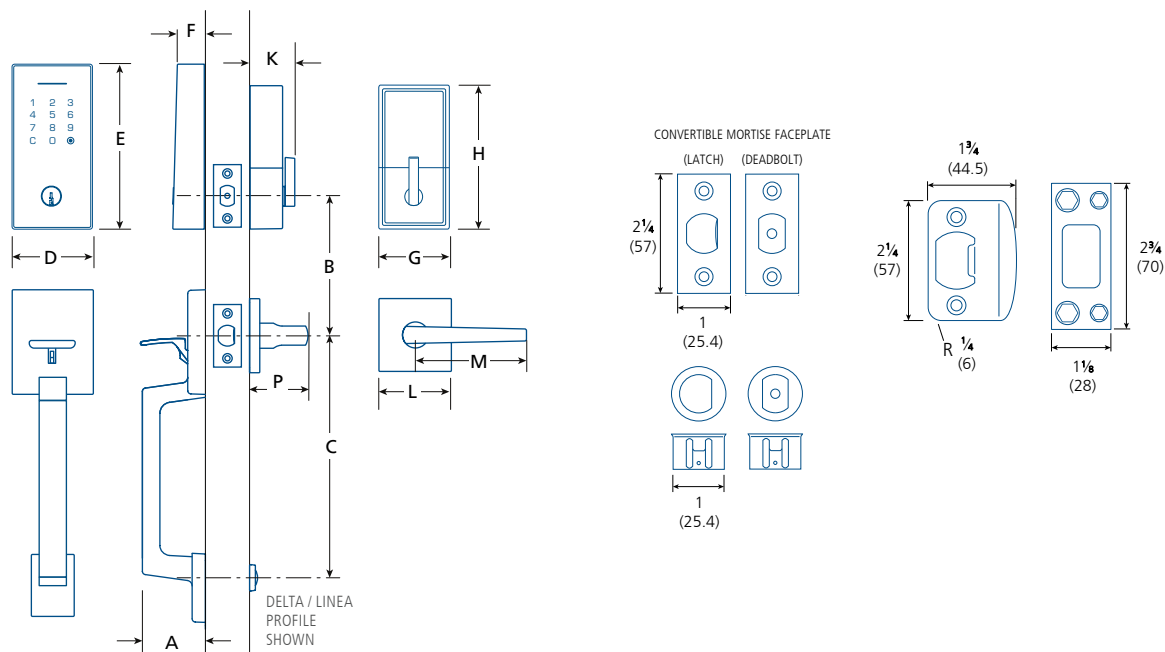

	A	B	C	D	E	F	G	H	K	L	M	P
T300 COMBO	2 1/8	5 1	8 13/32	2 5/8	5 3/4	1	2 11/16	5 3/16	1 1/2	2 9/16	4	2 3/8
DT LTS	(54)	(127)	(214)	(66)	(146)	(25.4)	(68)	(132)	(38)	(64.5)	(102)	(60)

IN (MM) (1) RECOMMENDED DISTANCE



DDL 1150 SERIES

DIGITAL LOCKSET



- Certifications** • 1 Year limited warranty
- Door Thickness** • 1 $\frac{3}{8}$ "–2" (35–51 mm)
- Handing** • Handed
- Backset** • 2 $\frac{3}{4}$ " (70 mm)
• 2 $\frac{3}{8}$ " (60 mm) – available
- Latch** • Stainless steel deadlatch
• $\frac{1}{2}$ " (12.7 mm) throw
- Faceplate** • Mortise type, square corners
• 1 $\frac{1}{8}$ "x2 $\frac{1}{4}$ " (29x57 mm)
- Strike** • 1 $\frac{1}{8}$ "x2 $\frac{3}{4}$ " (29x70 mm)
• Plastic dust-box
- Chassis** • Zinc alloy case with rubber seal
• Stainless steel mechanical push buttons
• Exposed mounting screws

- Preparation** • Cross bore: 2 $\frac{1}{8}$ " (54 mm)
• Edge bore: 1" (25.4 mm)
- Cylinder** —
- Function** Exterior lever always locked unless unlocked by entering correct combination or by inside lever.
- Lever Style** Lever with curved return
- Finish** SC–Satin chrome
Other finishes available by special order
- Notes** • Recommended for indoor use only
• Completely mechanical, no batteries required
• Easy combination changes

1150	SC	–	LH
SERIES	FINISH		HAND ¹

(1) LH– LEFT HAND; RH– RIGHT HAND

DIMENSIONS

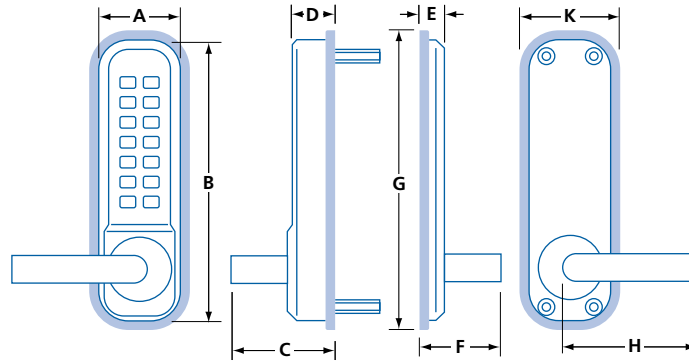

	A	B	C	D	E	F	G	H	K
1150	2 $\frac{1}{8}$ (54)	7 $\frac{9}{16}$ (185)	2 $\frac{1}{2}$ (64)	1 $\frac{5}{16}$ (33)	1 $\frac{3}{16}$ (20)	2 $\frac{1}{4}$ (57)	7 $\frac{1}{2}$ (190)	4 $\frac{5}{16}$ (110)	2 $\frac{7}{16}$ (62)

IN (MM)

PARTS & ACCESSORIES



DLSC238

Deadlatch bolt, 2 $\frac{3}{8}$ " (60mm) backset,
1 $\frac{1}{8}$ x2 $\frac{1}{4}$ " (29x57 mm) faceplate

DLSC234

Deadlatch bolt, 2 $\frac{3}{4}$ " (70mm) backset,
1 $\frac{1}{8}$ x2 $\frac{1}{4}$ " (29x57 mm) faceplate



DDL 2200 SERIES

DIGITAL LOCKSET



- Certifications** • 1 Year limited warranty
- Door Thickness** • $1\frac{3}{8}$ "–2" (35–51 mm)
• $2\frac{1}{4}$ " (57 mm) – available
- Handing** • Non handed
- Backset** • $2\frac{3}{4}$ " (70 mm)
• $2\frac{5}{8}$ " (60 mm) – available
• 2200 : $1\frac{1}{8}$ " (28 mm)
- Latch** • 2200: deadbolt; $\frac{7}{8}$ " (22 mm) throw
• 2212: deadbolt with security pin;
1" (25.4 mm) throw
• 2230: security deadlatch;
 $\frac{1}{2}$ " (12.7 mm) throw
- Faceplate** • Mortise type, square corners
• $1\frac{1}{8}$ x $2\frac{1}{4}$ " (29x57 mm)
• 2200: None, not applicable
- Strike** • T-Type; $1\frac{1}{8}$ x $2\frac{3}{4}$ " (29x70 mm)
• Plastic dust-box
• 2200: includes surface strike
- Chassis** • Zinc alloy case with rubber seal
• Stainless steel mechanical push buttons
• Exposed mounting screws

- Preparation** • Special, see installation instructions for details
• Trim plate for installation on doors with
 $2\frac{1}{8}$ " (54 mm) preparation – available
• 2200: surface mounted, fits any flat surface
door and frame

Cylinder —

- Function** Exterior knob always locked unless unlocked
by entering correct combination, or by turning
inside thumb-turn.

Knob Style Flat knob with ridges

Large diameter knob available – see parts & accessories

Finish AB–Antique bronze, PB–Polished brass,
SC–Satin chrome, SN–Satin nickel

Other finishes available by special order

- Notes** • Recommended for indoor use only
• Completely mechanical, no batteries required
• Easy combination changes

2230	SC
MODEL	FINISH

SELECTION GUIDE

MODEL	DESCRIPTION	FINISH
2200	Combination deadbolt lock, surface mounted, 1 1/8" (28mm) backset	SC
2212	Combination deadbolt lock, 2 3/4" (70mm) backset	AB, PB, SC
2230	Combination deadlatch lock, 2 3/4" (70mm) backset	SC, SN

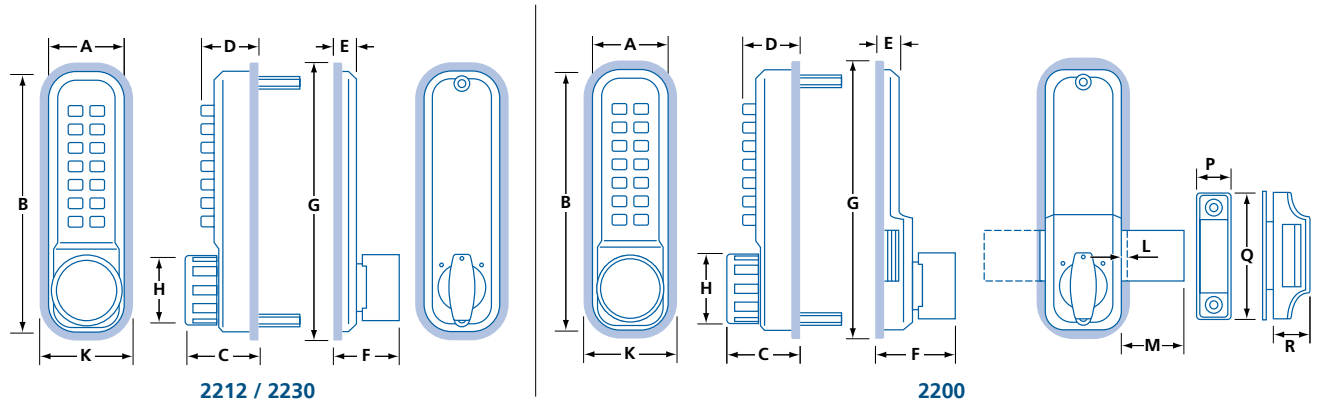

	A	B	C	D	E	F	G	H	K	L	M	P	Q	R
2200										1/16 (2)	7/8 (22)	25/32 (20)	2 3/4 (70)	7/8 (22)
2212	1 5/8 (41)	5 9/16 (143)	1 9/16 (40)	1 3/16 (30)	1 5/32 (12)	1 5/8 (42)	6 (152)	1 7/16 (36)	2 (51)	—	—	—	—	—
2230										—	—	—	—	—

IN (MM)

PARTS & ACCESSORIES



DLSC238
Deadlatch bolt, 2 3/8" (60mm) backset,
1 1/8 x 2 1/4" (29x57mm) faceplate



DLSC234
Deadlatch bolt, 2 3/4" (70mm) backset,
1 1/8 x 2 1/4" (29x57mm) faceplate



DBS238
Deadbolt, 2 3/8" (60mm) backset,
1 1/8 x 2 1/4" (29x57mm) faceplate

DBS234
Deadbolt, 2 3/4" (70mm) backset,
1 1/8 x 2 1/4" (29x57mm) faceplate

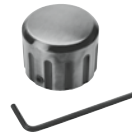

KNOB
Easy-grip knob, 1 3/4" (44mm) diameter.
» Antique brass (KNOBAB)
» Polished brass (KNOBBP)



RP2200
2 1/4" (57mm) door kit for DDL 2200.

RP2210
2 1/4" (57mm) door kit for DDL 2212,2230.

DETTP
Metal 2 1/2 x 6 1/2" (64 x 165mm) retro-fit trim
plate for pre-drilled 2 1/8" (54mm) doors.

DETPR
Rubber 2 1/2 x 6 1/2" (64 x 165mm) retro-fit trim
gasket for pre-drilled 2 1/8" (54mm) doors.



PF SERIES

GLASS DOOR LOCKS

1
YEAR



PF210
PASSAGE



SILENT LATCH



PF251
ENTRY (KIK CYLINDER)



PF251P
PROFILE CYLINDER

- Warranty** • 1 Year limited warranty
- Panel Thickness** • For tempered glass panels
 • $\frac{5}{16}$ – $\frac{1}{2}$ " (8–12.7 mm) thick
 • $\frac{19}{32}$ " (15 mm) extension kit (#PF2-EXT)
- Handing** • Handed, field reversible*
 (**Handing conversion is possible only from LH to RH or LHR to RHR (and vice versa). See handing guide.*)
- Spring Latch** • Stainless steel, $\frac{1}{2}$ " (12.7 mm) throw
 • Derlin stripe for silent/smooth operation
- Strike** • ASA strike – available
 • Metal frame strike – available
 • Glass panel strike – available
Strikes not included, sold separately. See Parts & Accessories
- Trim** • High strength zinc-alloy body
 • Stainless steel covers
Levers not included, sold separately. See Parts & Accessories
- Chassis** • Concealed mounting
 • Shims and gaskets included
- Preparation** • Glass cut-out required. See installation instructions for details
- Cylinder** • 5-pin cylinder
 • Schlage "C" keyway, 2 keys
 • Removable
 • Profile cylinders sold separately
Keying services available.
- Functions** 200 Glass panel strike
 210 Passage
 251 Entry
 251P Entry, profile cylinder (less core)
- Levers** • Wide variety of lever styles
 • Sold separately – see Parts & Accessories
- Finish** 630–Satin stainless steel
 19–Matte black*
 (**Special order. Other finishes also available by special order*)

PF	251	LH	–	630
SERIES	FUNCTION ⁽¹⁾	HAND		FINISH

(1) SEE SELECTION CHART FOR DETAILS

(2) LH: LEFT RH: RIGHT LHR: LEFT, REVERSED RHR: RIGHT, REVERSED

SELECTION GUIDE

SERIES	FUNCTION / DESCRIPTION	FINISH ¹	/ CASE
PF	210 Passage	630, 19*	20
PF	251 Entry, cylinder included ➔	630, 19*	20
PF	251P Entry, profile cylinder (less core)	630, 19*	20
PF	200 Strike for glass side panel	630, 19*	**

(1) OTHER FINISHES AVAILABLE, MINIMUM ORDER QUANTITIES AND/OR ADDITIONAL DELIVERY TIMES MAY BE REQUIRED. (*) SPECIAL ORDER, MAY REQUIRE ADDITIONAL DELIVERY TIME
 (**) CONTACT LOCAL REPRESENTATIVE FOR DETAILS. ➔ KEYED FUNCTION; FULL KEYING SERVICES AVAILABLE.

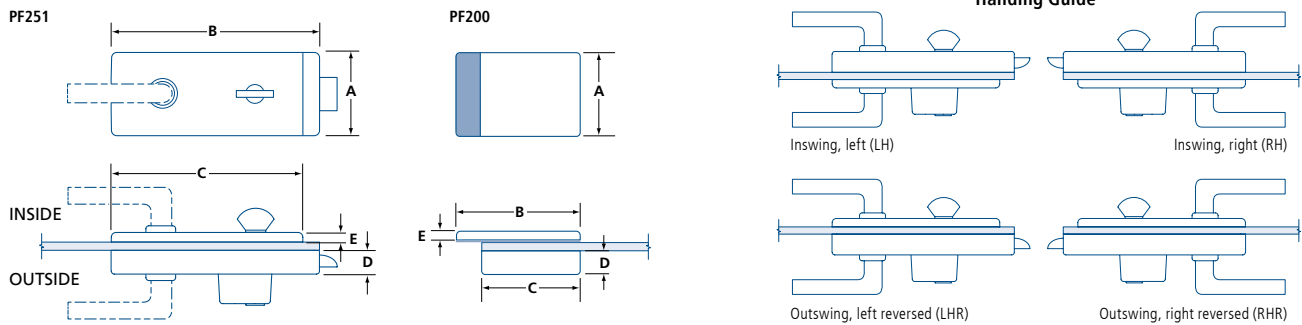

	A	B	C	D	E
PF210	2 ⁵ / ₈	6 ¹ / ₂	5 ⁷ / ₈	7 ⁷ / ₈	5 ⁵ / ₁₆
PF251	(67)	(165)	(150)	(22)	(8)
PF200	2 ⁵ / ₈	3	2 ³ / ₈	7 ⁷ / ₈	5 ⁵ / ₁₆
	(67)	(76)	(60)	(22)	(8)

IN (MM)

PARTS & ACCESSORIES



PFL001-32D
Straight lever style (sold in pairs).



PFL018-32D
Curved lever style (sold in pairs).



CBPT1530-SCKD-15
Schlage "C" keyway profile cylinder with thumb-turn. Not rekeyable. For LH/RH PF251P locks.



CBPT3131-SCKD-15
Schlage "C" keyway profile cylinder with thumb-turn. Not rekeyable. For LHR/RHR PF251P lock.



9203
Viro profile cylinder, double cylinder brass plated. Required for master key systems with PF251P. Rekeyable.



LS01
For metal door frames 1³/₄" to 2" (44.5 mm to 50 mm) thick. Includes dust-box, mounting plate and machine screws.



ASAC15
ASA strike for 1³/₄" to 2" (44.5 mm to 50 mm) door frame. 1¹/₄x4⁷/₈" (32x124 mm)



PF200
Patch fitting lock strike for glass side panel up to 1⁹/₃₂" (15 mm) thick.



PF2-EXT
Extension kit for panel thicknesses up to 1⁹/₃₂" (15 mm). For PF210 or PF251.



PF SERIES

GLASS DOOR FLOOR DEADBOLTS

1
YEAR



PF181
FLOOR DEADBOLT



PF180
FLOOR DEADBOLT

Warranty • 1 Year limited warranty

Panel Thickness • For tempered glass panels
5/16–1/2" (8–12.7 mm) thick

Handing • Non-handed

Deadbolt • Solid zinc-alloy floor bolt
• 1 1/16" (17.5 mm) throw
• PF180: round bolt, 3/32" (2.4 mm) thick
• PF181: flat bolt, 3/32" (2.4 mm) thick

Strike • Steel floor strike
• Dust-proof floor strike – available*
(*) For PF180 only. See Parts & Accessories

Trim • High strength zinc-alloy body
• Stainless steel covers

Chassis • Concealed mounting
• Shims and gaskets included

Preparation • Glass cut-out required. See installation instructions for details

Cylinder • PF180: 4-pin profile double cylinder
• PF181: 5-pin profile double cylinder
• Yale keyway, 3 keys

Other keyways and keying options available.

Finish 630–Satin stainless steel
19–Matte black*

() Special order. Other finishes also available by special order*

PF	180	–	630
SERIES	FUNCTION ¹		FINISH

(1) SEE SELECTION CHART FOR DETAILS



DOREX[®]

PLH900
UNIVERSAL PATCH LOCK & STRIKE HOUSING



PLH900UNIVERSAL PATCH LOCK
& STRIKE HOUSING SYSTEM

PLH901ESL-630

PLH900DM84LS-630

The **PLH900** redefines flexibility in glass door security. Unlike fixed-format systems, the PLH900 is a universal housing and strike solution engineered to support a wide range of DOREX locks. Whether you're installing mortise center locks, cylindrical locks, deadbolts, or even electric strikes, the PLH900 adapts—making it the most versatile option for interior glass applications in commercial and architectural environments.

Designed for strength, compatibility, and clean aesthetics, the PLH900 is ideal for offices, storefronts, and modern interiors where adaptability and performance are key.

UNIVERSAL LOCK HOUSING

The PLH900 supports DOREX mortise center locks, cylindrical door locks, and deadbolt locks.

UNIVERSAL STRIKE HOUSING

The PLH901 accepts common lock strikes, deadbolt strikes included with your DOREX lock, or the SGT78 electric strike for access control integration.

ARCHITECTURAL DESIGN

Concealed mounting screws offer a clean contemporary finish, designed to complement any glass door or glass door partition system.

MODULAR & FUTURE-PROOF DESIGN

The PLH900 is built with modularity in mind. With a simple internal adjustment and new housing covers, the PLH900 can be reconfigured for different lock types, handing and glass thickness. No new housing required, just a new lock and covers.

EASY INSTALLATION & RETROFIT-FRIENDLY

Designed for flexible installation in new or retrofit projects with minimal modifications and no silicone adhesives. Can fit existing popular glass door preparations.

HEAVY-DUTY PERFORMANCE

Engineered for high-traffic commercial settings, ensuring long-term reliability and durability.

TECHNICAL SPECIFICATIONS

Housing Dimensions • 6" x 10" (152.4 x 254 mm) with covers

Material • Machined aluminum housing with removable stainless-steel covers

Glass Thickness • 10mm–12.7mm (3/8" to 1/2")

Projection • 7/8" (22.2 mm) from glass surface

Lock Compatibility (with PLH900)

- Mortise center locks: DOREX DM (all functions)*
- Cylindrical locks: DOREX F1, GX1, F, T2, RW, CW, EM, TL
- Deadbolt locks: DOREX GX1A, TLA, FHA, DG1, DG2, F500

(*) When paired with PLH901ES and/or SGT78 electric strike, the number of available functions is limited to non-deadbolt functions.

Strike Compatibility (with PLH901)

- Dorex DM strikes (all functions)
- Standard ASA strike 1 1/8 x 2 3/4 in (29 x 70 mm)
- Common deadbolt strike 1 1/8 x 2 3/4 in (29 x 70 mm)
- SGT78 Electric Strike

Electric Strike Compatibility (with door frame)

- SGT78 Electric Strike - sold separately
- CX-ED1579L Electric Strike - sold separately

NOTE: When PLH900 is installed within a standard door frame, any electric strike can be used, provided that it can accommodate the lock and function installed.

Warranty • 1-year limited warranty

- Installed locks and electric strikes are covered by their own warranties.

Application Interior tempered glass doors. Ideal for:

- Commercial Office Fronts
- Sheltered Retail Storefronts
- Hospitality Suites
- Medical & Institutional Interiors
- Access-Controlled Glass Partitions

Finishes



* COATING AFFECTS APPEARANCE OF THE FINISH; RESEMBLES SATIN NICKEL.

DIMENSIONS

PLH900 and PLH901 have the same overall dimensions.

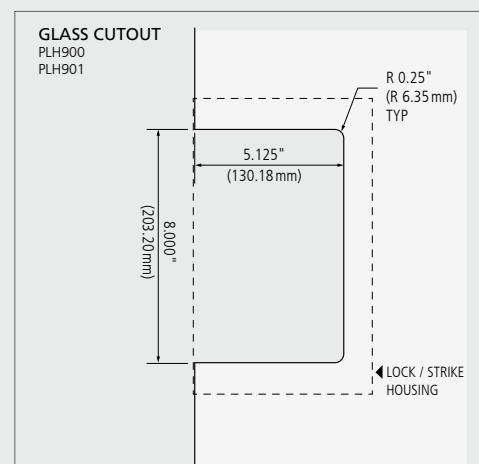
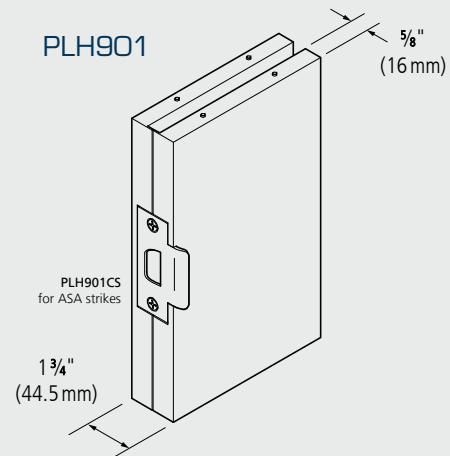
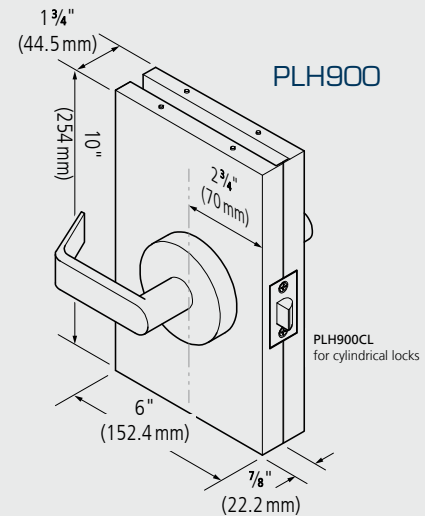

* Accommodates glass cuts for CLM9000, DL61 models with included brackets.
* See installation instructions for details.

HOW TO ORDER

Begin by selecting the lock type and function required, then determine handing if required.

DOOR HANDING GUIDE

Always determined from the outside facing in.

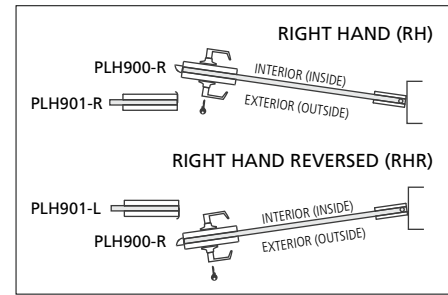
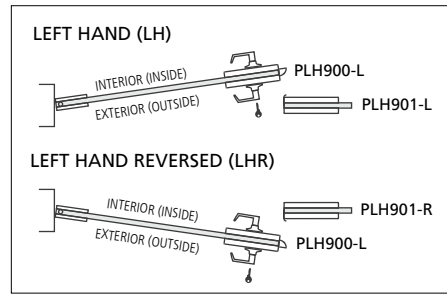

PLH900 LOCK HOUSING

PLH	900	DM	80	R	S	-	630
SERIES	HOUSING	LOCK TYPE	FUNCTION*	HAND*	TRIM*		FINISH
DM		MORTISE					
CL		CYLINDRICAL*					
DB		DEADBOLT*					
(*) FULLY REVERSIBLE, NO FUNCTION, HANDING, OR TRIM INDICATION IS REQUIRED.							
			10 - PASSAGE				630 - SATIN STAINLESS STEEL
			42 - PRIVACY				693 - MATTE BLACK
			45 - ENTRY				SS15P - SATIN STEEL, ANTI-FINGERPRINT
			50 - OFFICE*				
			56 - DORMITORY				
			70 - CLASSROOM*				
			80 - STOREROOM*				
			84 - STOREROOM W/ DEADBOLT				
(*) WHEN PAIRED WITH PLH901ES AND/OR SGT78 ELECTRIC STRIKE, ONLY THESE NON-DEADBOLT FUNCTIONS ARE AVAILABLE.							
				R			
				L			
					S		
					E		
(*) ACCEPTS DM STANDARD (E) AND EXTENDED (E2) ESCUTCHEON.							

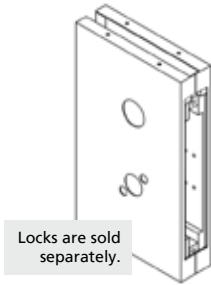

Locks are sold separately.

PLH901 STRIKE/KEEPER HOUSING

PLH	901	MS	R	-	630
SERIES	HOUSING	STRIKE TYPE ¹	HAND ²		FINISH
MS		MORTISE			
CS		CYLINDRICAL			
DS		DEADBOLT*			
ES		ELECTRIC STRIKE (SGT78 ONLY)**			
(*) FULLY REVERSIBLE, NO HANDING INDICATION REQUIRED.					
(**) SGT78 SOLD SEPARATELY					
			R		
			L		
					630 - SATIN STAINLESS STEEL
					693 - MATTE BLACK
					SS15P - SATIN STEEL, ANTI-FINGERPRINT

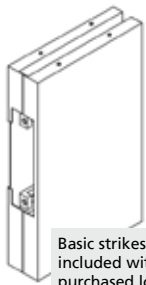

Basic strikes are included with purchased locks.
Electric strike sold separately.

MODEL	DESCRIPTION	COMPATIBLE PRODUCTS
PLH 900 DM	Patch lock housing, DM mortise lockset <i>Indicate handing, trim type, and lock function. Covers are not reversible.</i>	DOREX DM (all functions) ¹
PLH 900 CL	Patch lock housing, cylindrical lockset <i>Non-handed, covers are reversible.</i>	DOREX F1, GX1, F, T2, RW, CW, EM, TL
PLH 900 DB	Patch lock housing, deadbolt lockset <i>Non-handed, covers are reversible.</i>	DOREX GX1A, TLA, FHA, DG1, DG2, F500
PLH 901 MS	Patch strike housing, mortise lock strike <i>Indicate handing, covers are not reversible.</i>	DOREX DM strikes (all functions)
PLH 901 CS	Patch strike housing, cylindrical lock strike <i>Indicate handing, covers are not reversible.</i>	Standard ASA strike
PLH 901 DS	Patch strike housing, deadbolt lock strike <i>Non-handed, covers are reversible.</i>	Deadbolt strike; 1½x2¾in (29x70mm)
PLH 901 ES	Patch strike housing, SGT78 electric strike <i>Indicate handing, covers are not reversible.</i>	SGT78 Electric Strike

(1) WHEN PAIRED WITH PLH901ES AND/OR SGT78 ELECTRIC STRIKE, THE NUMBER OF AVAILABLE FUNCTIONS IS LIMITED TO NON-DEADBOLT FUNCTIONS.



Need Help?

Our door hardware professionals are always available to help you determine the best door hardware configuration for your opening or application.

Don't hesitate – take advantage of our experience and contact your local Canaropa branch or office.

MONTRÉAL 514-636-6466 • TORONTO 461-241-4445 • CALGARY 403-250-9433 • VANCOUVER 604-279-2524

SELECTION GUIDE

SERIES	FUNCTION / DESCRIPTION	FINISH ¹	/ CASE
PF 181	Flat floor bolt, 5-pin profile double cylinder 	630, 19*	**
PF 180	Round floor bolt, 4-pin profile double cylinder 	630, 19*	**

(1) OTHER FINISHES AVAILABLE, MINIMUM ORDER QUANTITIES AND/OR ADDITIONAL DELIVERY TIMES MAY BE REQUIRED. (*) SPECIAL ORDER, MAY REQUIRE ADDITIONAL DELIVERY TIME
 (**) CONTACT LOCAL REPRESENTATIVE FOR DETAILS.  KEYED FUNCTION; FULL KEYING SERVICES AVAILABLE.

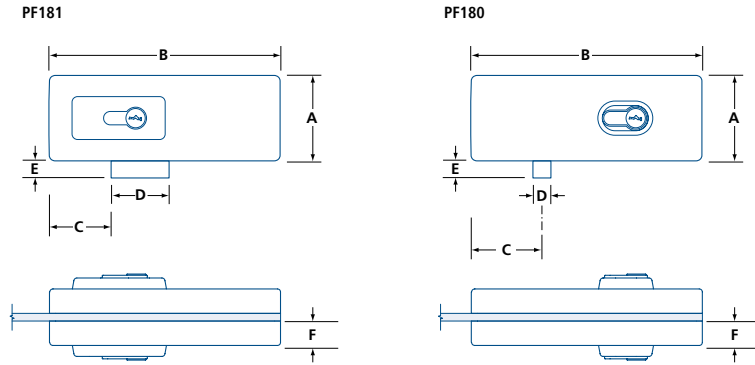

	A	B	C	D	E	F
PF181	2 (51)	6 ⁷ / ₁₆ (163.3)	2 ¹ / ₈ (54)	1 ⁷ / ₁₆ (36)	1 ¹ / ₁₆ (17.5)	3 ⁸ / ₁₆ (9)
PF180	2 (51)	6 ⁷ / ₁₆ (163.3)	3 ¹⁵ / ₃₂ (87.7)	9 ¹ / ₁₆ (14.6)	1 ¹ / ₁₆ (17.5)	5 ¹ / ₁₆ (8)

IN (MM)

PARTS & ACCESSORIES



CBPT3131-SCKD-15
 Schlage "C" keyway profile cylinder with thumb-turn for PF181 locks.



9203
 Viro profile cylinder, brass plated. Required for master key systems with PF181.



T840
 Aluminum dust-proof strike with spring loaded plunger; 3/4" (19 mm) engagement depth. Can be used with PF180. See page 06.305.



DSP / DSPL
 Adjustable stainless steel dust-proof strike with spring loaded plunger; 3/4" (19 mm) engagement depth. Available with locking (DSPL) and non-locking plunger (DSP). Can be used with PF180. See page 06.305.



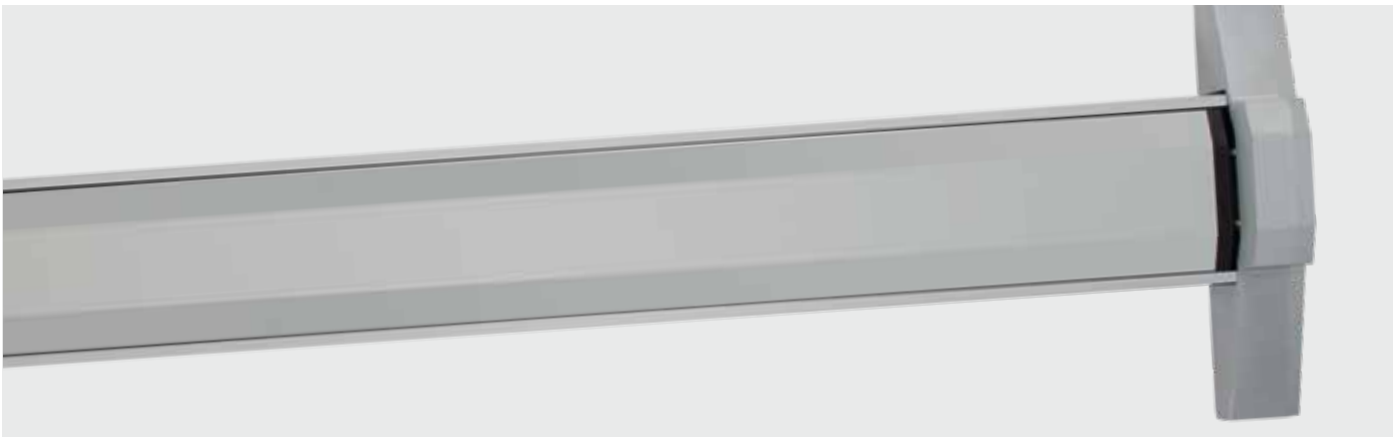

EXIT DEVICES TABLE OF CONTENTS

Exit Device Handing Guide.....	ii
Finish Guide.....	ii
Abbreviation Guide.....	iii

PUSH PAD EXIT DEVICES

DOREX DX1 Series, Grade 1 BHMA	02.010
DOREX 9500 Series, Grade 1 BHMA	02.020
DOREX 8500 Series, Grade 2	02.030
D8DIVISION8 8000 Series, Grade 2.....	02.040
DOREX DX2 Series, Narrow Stile, Grade 1 BHMA	02.100
1400 Series, Narrow Stile	02.110
2295 Series, Narrow Stile	02.120

CROSSBAR EXIT DEVICES

DOREX NH900 Series, Grade 2.....	02.200
DOREX 1100 Series, Narrow Stile	02.210

R20250410



EXIT DEVICE HANDING GUIDE

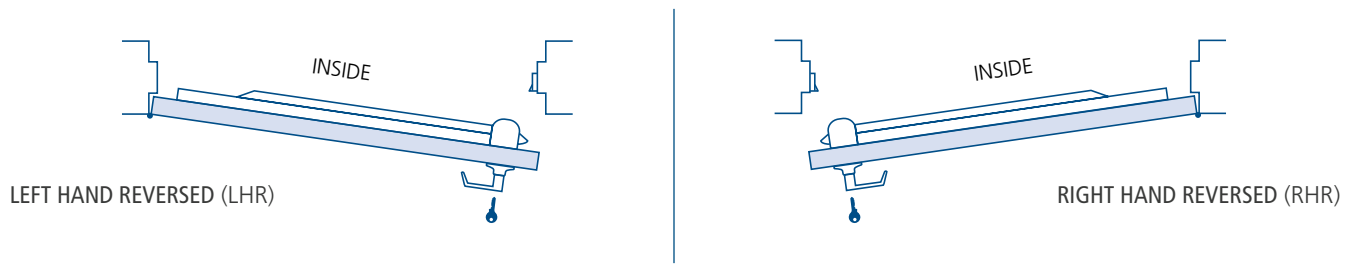

FINISH GUIDE

				
	ALUMINUM	BRASS	DARK BRONZE	MATTE BLACK
CODE	AL, C28, 28	BP, PB, C3, 3	DU, C20D, 20D	MB, C19, 19
BHMA*	628, 689	605, 632, 677	649, 650, 690	622, 631
				
	SATIN CHROME	SATIN STAINLESS STEEL		
CODE	SC, C26D, 26D	SS, C32D, 32D		
BHMA*	626, 652	630		

ALL FINISHES IMAGES ABOVE ARE PHOTOGRAPHIC OR COLOUR APPROXIMATIONS, DELIVERED PRODUCT MAY VARY IN COMPARISON OR BETWEEN ORDERS/LOTS.

OTHER FINISHES AVAILABLE-PLEASE CONTACT.

(*) EQUIVALENT; CODES DIFFER DEPENDING ON BASE MATERIAL AND/OR FINISH PROCESS.













EXIT DEVICES GENERAL INFORMATION

ABBREVIATION GUIDE

GENERAL

BS	Backset
DIA, Ø	Diameter
KG	Kilograms
LBS	Pounds
LH	Left hand
LHR	Left hand reversed
MAX	Maximum
MIN	Minimum
N/A, —	Not applicable / Not available
QTY	Quantity (usually followed by notes)
RH	Right hand
RHR	Right hand reversed
SQ, ▣	Square
WT	Weight
/UNIT	Number of items per basic unit of sale (bagged or boxed)
/BOX, /BAG	Number of UNITS found in an inner carton or bag
/CASE	Number of BOXES or UNITS found in an outer (shipping) carton

LEGEND

  	FIRE RATED product. Sometimes includes duration of fire-resistance in minutes (M) or hours (H).
	Small or Large Format Interchangeable Core (SFIC/LFIC) model or option available.
	Keyed product or function. Keying services may be available.
	Product, configuration or option meets ADA (Americans with Disabilities Act) requirements.
	GRADE 1 product meets or exceeds standardized testing requirements for high traffic, commercial applications.
	GRADE 2 product meets or exceeds standardized testing requirements for moderate traffic, commercial applications.
	Tested to Canadian and/or American safety and performance standards by Underwriters Laboratories® (UL).
	Certified by the Builders Hardware Manufacturers Association® / American National Standards Institute®.
  	Limited warranty length in years, applicable to mechanical, electronic, or finish aspects of a product.



DOREX[®]



DX1
GRADE 1 EXIT DEVICES

DX1

DX1 Series Exit Devices are designed and manufactured for simplicity, strength, durability, aesthetics and installer-friendly innovations.

- Devices and trims are designed for new or retrofit installation into other manufacturers' exit devices and trims.
- Made to comply with the highest safety and security standards in the industry.
- cULus listed for Panic Exit Hardware or 3-hour Fire Rated Exit Hardware.
- Certified ANSI/BHMA A156.3-2014 Grade 1.

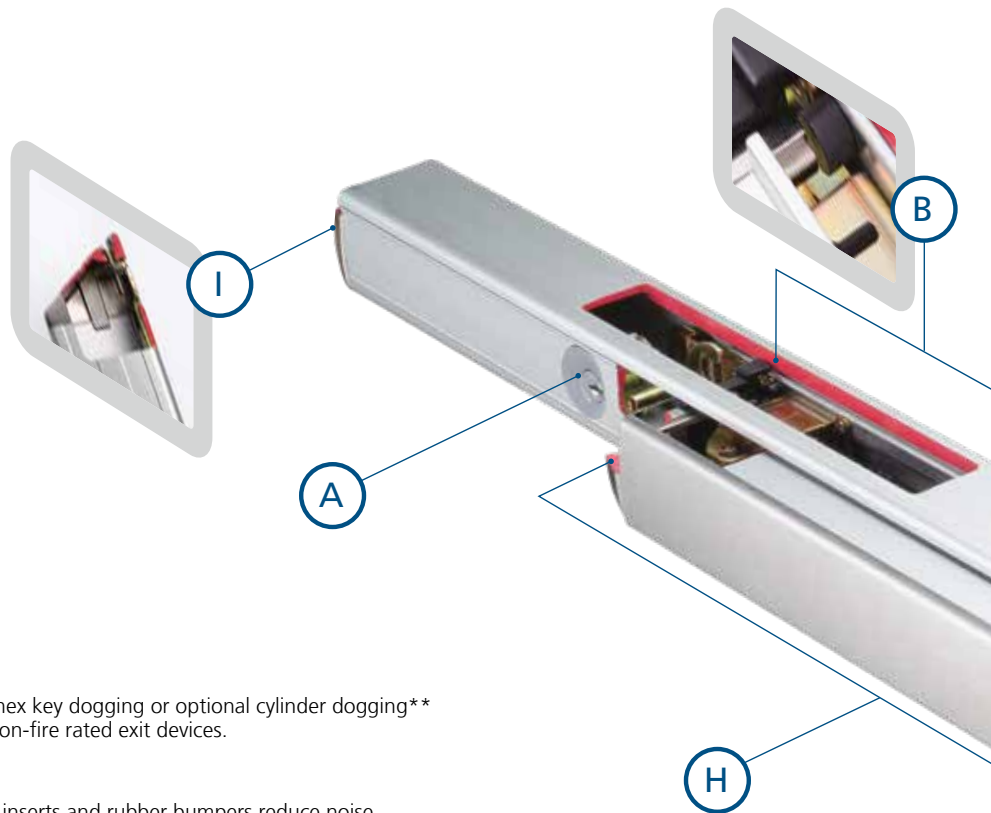

- A** Standard flat/hex key dogging or optional cylinder dogging** available for non-fire rated exit devices.
- B** Special plastic inserts and rubber bumpers reduce noise.
- C** Detachable center case allows switching between mechanical and electrical options which replaces the need of buying two complete sets.
- D** Replaceable cam breaks at a predetermined load to prevent further damage of the trim mechanism. Handing change is simple and easy.
- E** Stainless steel latch and security deadlatch.
- F** Center case with maximum versatility, surface and concealed vertical rods can be adjusted inside the center case with an ingenious rod holder design.

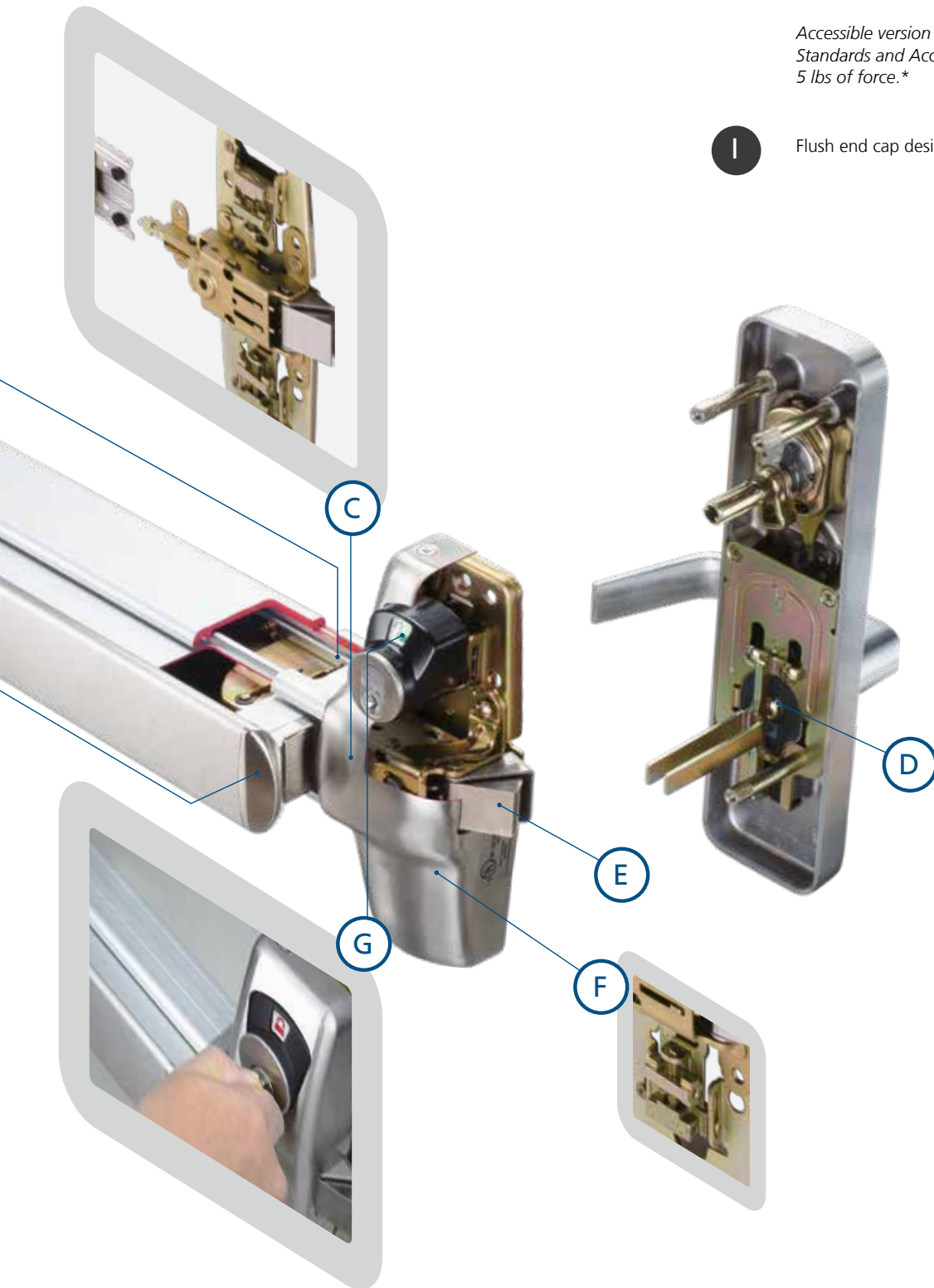

G

Double cylinder with indicator devices are used as classroom intruder locks, enabling the locking of the outside trim without opening the door.*

H

Push bar with integrated end caps and pivot add stability and make the bar move smoothly regardless of where the pressure is applied on push bar.

Accessible version is also available to meet the 2010 ADA Standards and Accessible Design to operate the device with 5 lbs of force.*

I

Flush end cap design.

BHMA[®]
CERTIFIED

UL[®] US
LISTED

* SPECIAL ORDER – WILL REQUIRE ADDITIONAL LEAD TIME AND MINIMUM ORDER QUANTITIES.

** CYLINDERS SOLD SEPARATELY

General Overview

Device Material

DX1 Series exit devices are furnished standard with a smooth case. Models with a grooved case are available by special order. The two styles are mechanically and dimensionally identical and are available in a wide selection of finishes (see finish chart below).

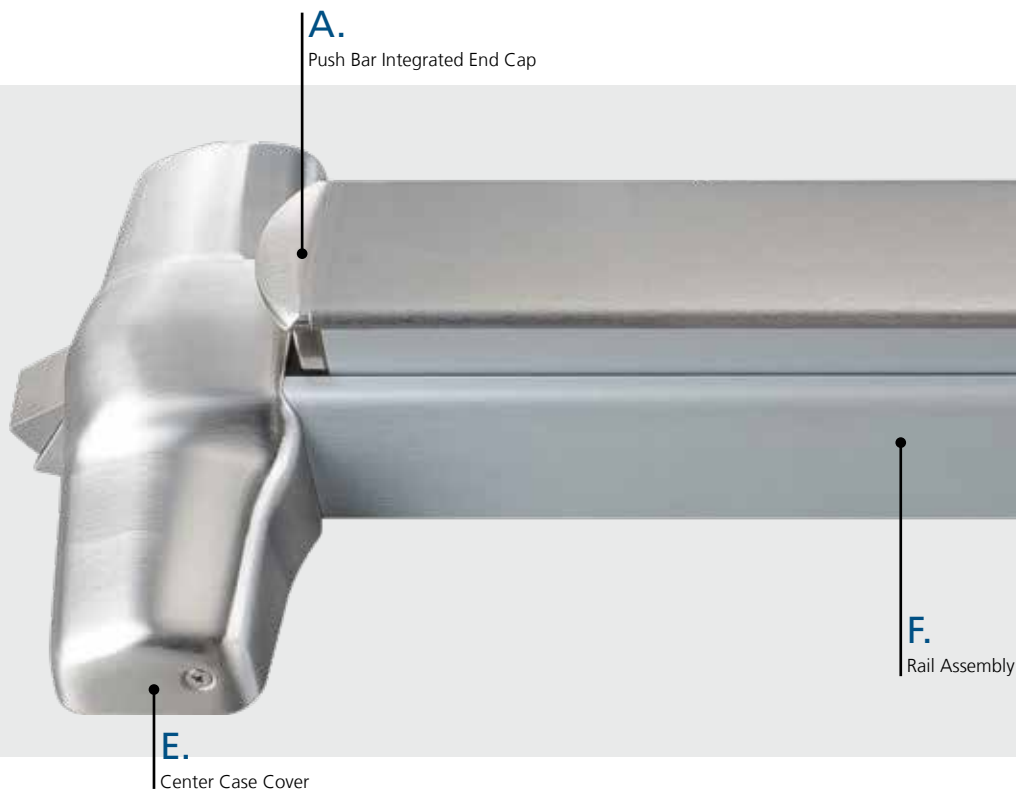

Available Finishes

Color	ANSI/BHMA	US	Part Material & Finish:		
			B / E / G	A / D	C / F / H
Satin Stainless Steel	630	32D	Stainless Steel, Satin	Plated	Anodized ¹
Satin Chrome*	626	26D	Brass, Satin & Plated	Plated	Anodized ¹
Polished Chrome*	625	26	Brass, Polished & Plated	Plated	Buffed Anodized ¹
Oil Rubbed Bronze*	613	10B	Bronze, Satin; Dark Oxidized	Plated	Anodized ¹
Satin Bronze*	612	10	Bronze, Satin	Plated	Anodized ¹
Polished Bronze*	611	9	Bronze, Polished	Plated	Buffed Anodized ¹
Satin Brass*	606	4	Brass, Satin	Plated	Anodized ¹

(*) Special order finish, will require additional lead time and minimum order quantities. (1) Aluminum material

NOTE: Non-listed finishes are available—please contact your sales representative.

(B) Push Bar Options^t:

- Embossed "PUSH"
- Braille, embossed "CAUTION STAIRWELL"
- Red silk screen lettered "EMERGENCY EXIT ONLY - PUSH TO OPEN & SOUND ALARM"

(^t) Please contact sales representative prior to ordering.

Mechanism Case

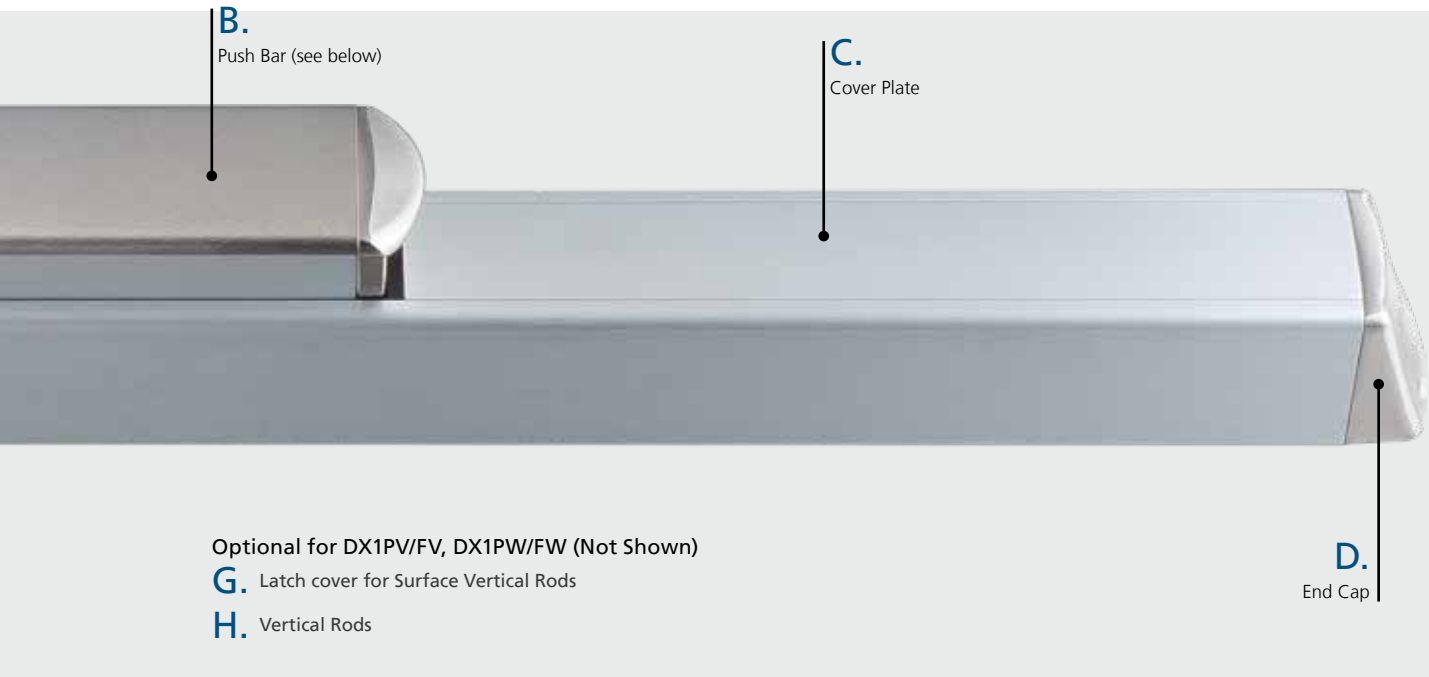

Available Functions

ANSI/BHMA Number	Operation	Trim Option		
		<i>DX1TT Series Thumb Piece</i>	<i>DX1TE Series Escutcheon</i>	<i>DX1TP Series Pull Handle</i>
01	Exit only, blank escutcheon or plate.	<i>DX1TTR01*</i>	N	N
02	Entrance by trim when bar is locked down/dogged.	<i>DX1TTR02*</i>	<i>DX1TER02*</i>	<i>DX1TPXR2*</i>
03	Entrance by trim. Key retracts latch. Key removable only when locked. (Night Latch)	<i>DX1TTR03 / DX1TTM03*</i>	N	N
05	Entrance by thumb piece. Key locks/unlocks thumb piece.	<i>DX1TTR05 / DX1TTM05*</i>	N	N
07	Entrance by thumb piece. Inside/outside key locks/unlocks thumb piece. Outside key releases latch. (Double Cylinder)	<i>DX1TTM05*</i>	N	N
08	Entrance by knob/lever. Key locks or unlocks knob/lever.	N	<i>DX1TER08/ DX1TEM08</i>	<i>DX1TPR08 / DX1TPM08*</i>
09	Entrance by knob/lever only when released by key. Key removable only when locked. (Night Latch)	N	<i>DX1TER09/ DX1TEM09</i>	<i>DX1TPR09 / DX1TPM09*</i>
10	Entrance by knob/lever. Inside/outside Key locks/unlocks knob/lever. Outside key releases latch. (Double Cylinder)	N	<i>DX1TER08*/DX1TEM08*</i>	N
14	Entrance by trim when latch is released by knob/lever.	N	<i>DX1TER14 / DX1TEM14*</i>	<i>DX1TPR14 / DX1TPM14*</i>
15	Entrance by trim when latch is released by thumb piece.	<i>DX1TTR15* / DX1TTM15*</i>	N	N

See pages 13–18 for more details.

Note: Device function handing is field reversible. Pull latch trim (DX1TH) available - see page 14.

Dimensions

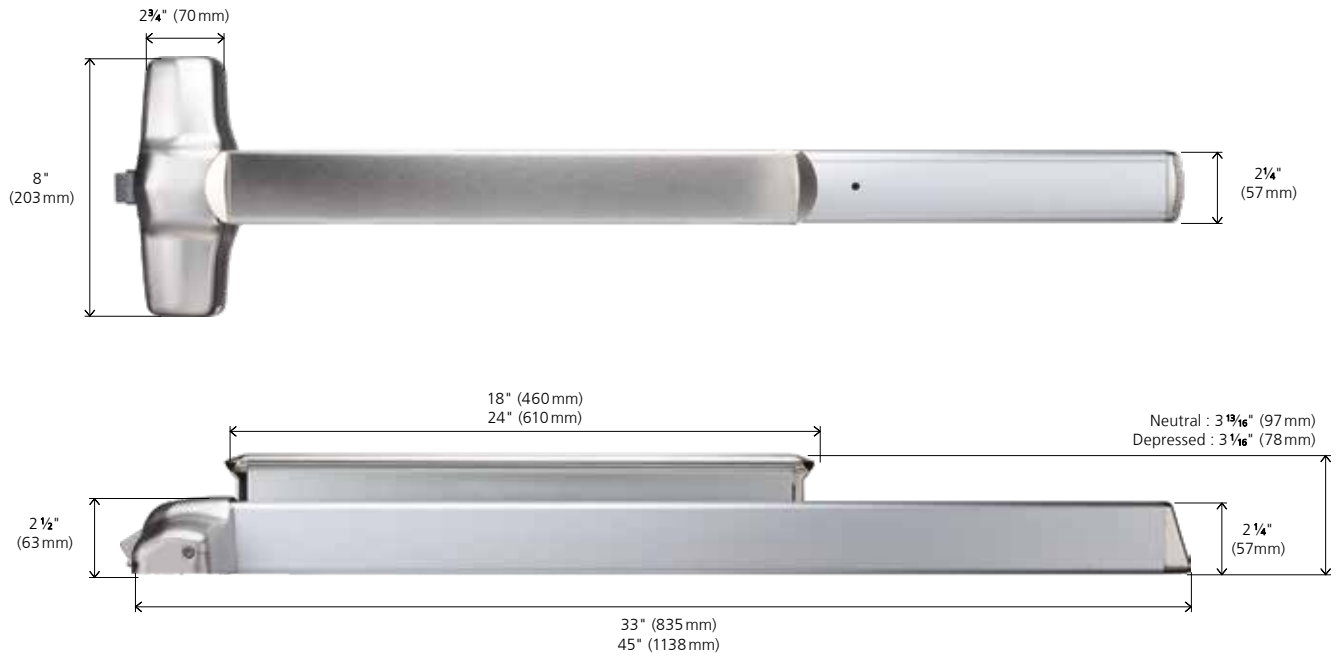

Exit Device Trims

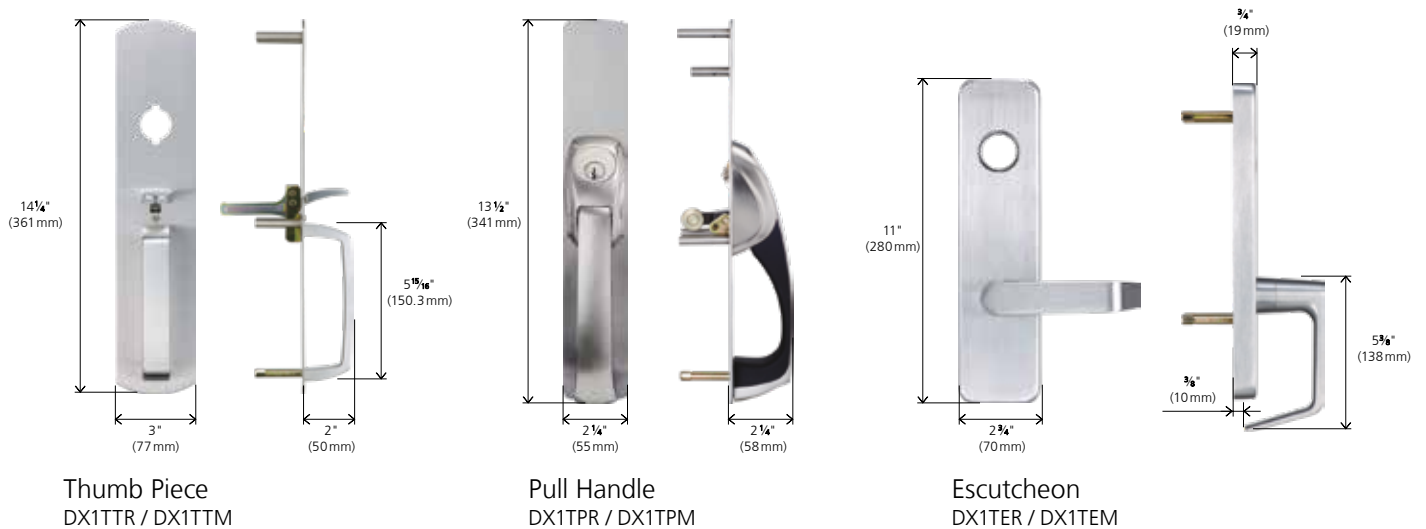

Mortise Case

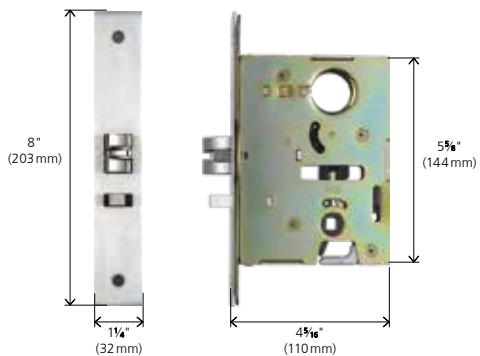

The DX1PM/FM model mortise lock is equipped with a 3/4" (19 mm) anti-friction stainless steel latchbolt with reversible handing. It has a non-handed auxiliary bolt for deadlocking and a faceplate with an adjustable bevel. Fits door machined for ANSI A156.115 mortise lock preparation.



Double Cylinder with Indicator*



An indicator device and cylinder (included) installed on the inner side of door informs whether the outside trim is in a locked or unlocked state.

Requires DX1TER08 Outside Trim.

When only the inside key cylinder is required to lock or unlock the outside trim and no outside cylinder operation is necessary for use with DX1TER08 (outside trim will be with blank mortise cylinder). Exit device cylinder included. Trim cylinder is not included.

- Certifications**
- Certified ANSI/BHMA A156.3-2014, Grade 1
 - cULus listed for Panic Hardware
 - cULus listed for 3hr Fire Exit Hardware
 - Complies with NFPA 80 Fire doors
 - ADA compliant model available

- Center Case & Rail Assembly**
- Heavy wrought steel center case
 - Adjustments accessible through center case after installation
 - Aluminum rail assembly, field sizeable

- Handing**
- Non-handed
 - Except for double-cylinder* option
 - Trims are field reversible

- Door Width**
- 30–38" (762–965 mm)
 - 36–48" (914–1219 mm) – option

- Door Height**
- 7–8 ft (2134–2438 mm) – standard

- Door Thickness**
- 1 3/4–2 1/4" (45–57 mm) – standard

- Stile Width**
- 4 1/2" (114 mm) minimum
- Measured from door edge*

- Center Latch**
- Stainless steel, 3/4" (19 mm) throw
 - Deadlocking

- Strike**
- PANIC: Steel, roller type #DXAS106 –standard
 - FIRE: Steel, roller type #DXAS108 –standard

See DX1 Accessories, p.19-21.

- Dogging**
- NOT available on FIRE EXIT hardware
 - Flat key dogging – standard
 - Cylinder dogging – option*

- Cylinder**
- Trim cylinder NOT included, sold separately
- See DX1 Cylinders, p. 22.*

- Mounting Hardware**
- Machine and wood screws – standard
 - Sex nut & thru-bolts – standard¹
 - Shims – standard

(1) With fire model only. Required for fire-rated wood or composite doors and non-reinforced hollow metal doors. See DX1 Accessories, p.19-21.

- Electrical Options***
- Alarm kit
 - Delayed egress
 - Electronic latch retraction
 - Request to exit
 - Signal switch
 - Electrical mortise lock

() Special order. See DX1 Electrical, p. 23-29.*

- Trims**
- Compatible trims sold separately, easy to mix and match
- See DX1 Trims, p.13-18.*

- Finish**
- 630–Satin Stainless Steel
- Other finishes available by special order, see p. 4.*



- Certifications**
- Certified ANSI/BHMA A156.3-2014, Grade 1
 - cULus listed for Panic Hardware
 - cULus listed for 3hr Fire Exit Hardware
 - Complies with NFPA 80 Fire doors

- Center Case & Rail Assembly**
- Heavy wrought steel center case with top and bottom rod adjusters
 - Adjustments accessible through center case after installation
 - Aluminum rail assembly, field sizeable

- Handing**
- Non-handed
 - Trims are field reversible

- Door Width**
- 36" (914 mm) – standard
 - 48" (1219 mm) – option*

- Door Height**
- 7 ft (2134 mm) – standard
 - 8 ft (2468 mm) – option*
 - 10 ft (3048 mm) – option*

See DX1 Accessories, p. 19-21.

- Door Thickness**
- 1 3/4– 2 1/4" (45–57 mm) – standard

- Stile Width**
- 4 1/2" (114 mm) minimum
- Measured from door edge*

- Top Latch**
- Stainless steel, Pullman type, 5/8" (16 mm) throw
 - Deadlocking
 - Case : 4 1/2 x 2 1/8 x 1 1/2" (114 x 54 x 38 mm)

- Bottom Latch**
- Stainless steel, Pullman type, 5/8" (16 mm) throw
 - Deadlocking
 - Round bottom latch – available^{1*}
 - Case : 4 1/2 x 2 1/8 x 1 1/2" (114 x 54 x 38 mm)

(1) Panic only, not UL listed. Certified Grade 2.

- Fire Latch**
- Available for door openings 8 ft (2438 mm) wide x 8 ft (2438 mm) high
 - Included with Less Bottom Rod (L) option

See DX1 Accessories, p. 20.

- Strikes**
- PANIC
 - » Top: Steel, roller type #DXAS106 – standard
 - » Bottom: Steel, #DXAS227 – standard
 - FIRE
 - » Top: Steel, roller type #DXAS108 – standard
 - » Bottom: Steel, #DXAS227F – standard

See DX1 Accessories, p. 19-21.

- Dogging**
- NOT available on FIRE EXIT hardware
 - Flat key dogging – standard
 - Cylinder dogging – option*

- Cylinder**
- NOT included, sold separately
- See DX1 Cylinders, p. 22.

- Mounting Hardware**
- Machine and wood screws – standard
 - Sex nut & thru-bolts – standard¹
 - Shims – standard

(1) With fire model only. Required for fire-rated wood or composite doors and non-reinforced hollow metal doors.

See DX1 Accessories, p. 19-21.

- Electrical Options***
- Alarm kit
 - Delayed egress
 - Electronic latch retraction
 - Request to exit
 - Signal switch
 - Electrical mortise lock

(*) Special order. See DX1 Electrical, p. 23-29.

- Trims**
- Compatible trims sold separately, easy to mix and match

See DX1 Trims, p. 13-18.

- Finish**
- 630–Satin Stainless Steel

Other finishes available by special order, see p. 4.



BHMA
CERTIFIED

G1

UL
LISTED

3H

- Certifications**
- Certified ANSI/BHMA A156.3-2014, Grade 1
 - cULus listed for Panic Hardware
 - cULus listed for 3hr Fire Exit Hardware
 - Complies with NFPA 80 Fire doors

- Center Case & Rail Assembly**
- Heavy wrought steel center case with top and bottom rod adjusters
 - Adjustments accessible through center case after installation
 - Aluminum rail assembly, field sizeable

- Handing**
- Non-handed
 - Trims are field reversible

- Door Width**
- 36" (914 mm) – standard
 - 48" (1219 mm) – option*

- Door Height**
- 7 ft (2134 mm) – standard
 - 8 ft (2468 mm) – option*
 - 10 ft (3048 mm) – option*

See DX1 Accessories, p. 19-21.

- Door Thickness**
- 1 3/4" – 2 1/4" (45–57 mm) – standard

- Stile Width**
- 4 1/2" (114 mm) minimum
- Measured from door edge

- Top Latch**
- Stainless steel, Pullman type, 5/8" (16 mm) throw
 - Deadlocking
 - Case : 4 1/2" x 2 1/8" x 1 1/2" (114 x 54 x 38 mm)

- Bottom Latch**
- Stainless steel, Pullman type, 5/8" (16 mm) throw
 - Deadlocking
 - Round bottom latch – available^{1*}
 - Case : 4 1/2" x 2 1/8" x 1 1/2" (114 x 54 x 38 mm)

(1) Panic only, not UL listed. Certified Grade 2.

- Fire Latch**
- Available for door openings 8 ft (2438 mm) wide x 8 ft (2438 mm) high
 - Included with Less Bottom Rod (L) option

See DX1 Accessories, p. 20.

- Strikes**
- PANIC
 - » Top: Steel, #DXAS216 –standard
 - » Bottom: Steel, #DXAS227 –standard
 - FIRE
 - » Top: Steel, #DXAS216 –standard
 - » Bottom: Steel, #DXAS227F –standard
- See DX1 Accessories, p. 19-21.

- Dogging**
- NOT available on FIRE EXIT hardware
 - Flat key dogging – standard
 - Cylinder dogging – option*

- Cylinder**
- NOT included, sold separately
- See DX1 Cylinders, p. 22.

- Mounting Hardware**
- Machine and wood screws – standard
 - Sex nut & thru-bolts – standard¹
 - Shims – standard

(1) With fire model only. Required for fire-rated wood or composite doors and non-reinforced hollow metal doors.

See DX1 Accessories, p. 19-21.

- Electrical Options***
- Alarm kit
 - Delayed egress
 - Electronic latch retraction
 - Request to exit
 - Signal switch
 - Electrical mortise lock

(*) Special order. See DX1 Electrical, p. 23-29.

- Trims**
- Compatible trims sold separately, easy to mix and match
- See DX1 Trims, p. 13-18.

- Finish** 630–Satin Stainless Steel
- Other finishes available by special order, see p. 4.



- Certifications**
- Certified ANSI/BHMA A156.3-2014, Grade 1
 - cULus listed for Panic Hardware
 - cULus listed for 3hr Fire Exit Hardware
 - Complies with NFPA 80 Fire doors

- Center Case & Rail Assembly**
- Heavy wrought steel center case with top and bottom rod adjusters.
 - Adjustments accessible through center case after installation
 - Aluminum rail assembly, field sizeable

- Handing**
- Non-handed
 - Trims are field reversible

- Door Width**
- 36" (914 mm) – standard
 - 48" (1219 mm) – option*

- Door Height**
- 7 ft (2134 mm) – standard
 - 8 ft (2468 mm) – option*
 - 10 ft (3048 mm) – option*

See DX1 Accessories, p. 19-21.

- Door Thickness**
- 1 3/4" – 2 1/4" (45 – 57 mm) – standard

- Stile Width**
- 4 1/2" (114 mm) minimum
- Measured from door edge

- Center Latch**
- Stainless steel, deadlocking, 3/4" (19 mm) throw

- Top Latch**
- Stainless steel, Pullman type, 5/8" (16 mm) throw
 - Deadlocking
 - Case : 4 1/2" x 2 1/8" x 1 1/2" (114 x 54 x 38 mm)

- Bottom Latch**
- Stainless steel, Pullman type, 5/8" (16 mm) throw
 - Deadlocking
 - Round bottom latch – available^{1*}
 - Case : 4 1/2" x 2 1/8" x 1 1/2" (114 x 54 x 38 mm)

(1) Panic only, not UL listed. Certified Grade 2.

- Fire Latch**
- Available for door openings 8 ft (2438 mm) wide x 8 ft (2438 mm) high
 - Included with Less Bottom Rod (L) option

See DX1 Accessories, p. 20.

- Strikes**
- PANIC
 - » Top/Middle: Steel, roller type #DXAS106 – standard
 - » Bottom: Steel, #DXAS227 – standard
 - FIRE
 - » Top/Middle: Steel, roller type #DXAS108 – standard
 - » Bottom: Steel, #DXAS227F – standard

See DX1 Accessories, p. 19-21.

- Dogging**
- NOT available on FIRE EXIT hardware
 - Flat key dogging – standard
 - Cylinder dogging – option*

- Cylinder**
- NOT included, sold separately

See DX1 Cylinders, p. 22.

- Mounting Hardware**
- Machine and wood screws – standard
 - Sex nut & thru-bolts – standard¹
 - Shims – standard

(1) With fire model. Required for fire-rated wood or composite doors and non-reinforced hollow metal doors.

See DX1 Accessories, p. 19-21.

- Electrical Options***
- Alarm kit
 - Delayed egress
 - Electronic latch retraction
 - Request to exit
 - Signal switch
 - Electrical mortise lock

(*) Special order. See DX1 Electrical, p. 23-29.

- Trims**
- Compatible trims sold separately, easy to mix and match - See DX1 Trims, p. 13-18.

- Finish**
- 630-Satin Stainless Steel

Other finishes available by special order, see p. 4.



Double Cylinder with Indicator*



An indicator device and cylinder (included) installed on the inner side of door informs whether the outside trim is in a locked or unlocked state.

Requires DX1TTM05* or DX1TEM08* outside trim. When only the inside key cylinder is required to lock or unlock the outside trim and no outside cylinder operation is necessary for use with DX1TTM15* or DX1TEM14. Exit device cylinder included. Trim cylinder not included.

- Certifications**
- Certified ANSI/BHMA A156.3-2014, Grade 1
 - cULus listed for Panic Hardware
 - cULus listed for 3hr Fire Exit Hardware
 - Complies with NFPA 80 Fire doors

- Center Case & Rail Assembly**
- Heavy wrought steel center case.
 - Adjustments accessible through center case after installation
 - Aluminum rail assembly, field sizeable

- Handing**
- Non-handed
 - Except for double-cylinder* option
 - Trims are field reversible

- Door Width**
- 36" (914mm) – standard
 - 48" (1219mm) – option*

- Door Height**
- 7–8ft (2134–2438mm) – standard

- Door Thickness**
- 1 3/4– 2 1/4" (45–57mm) – standard

- Stile Width**
- 4 1/2" (114mm) minimum
- Measured from door edge*

- Center Latchbolt**
- Stainless steel, 3/4" (19mm) throw
 - Anti-friction
 - Deadlocking

- Strike**
- Steel, #DXAS306 –standard
- See DX1 Accessories, p. 19-21.*

- Dogging**
- NOT available on FIRE EXIT hardware
 - Flat key dogging – standard
 - Cylinder dogging – option*

- Mortise Case**
- Mortise lock and strike included
 - Fits ANSI/BHMA A156.115 door preparation
 - Adjustable faceplate for bevelled doors up to 1/8" over 2" (3mm over 51mm)
 - Handed; field reversible
- See DX1 Dimensions, p. 6.*

- Cylinder**
- Trim cylinder NOT included, sold separately
- See DX1 Cylinders, p. 22.*

- Mounting Hardware**
- Machine and wood screws – standard
 - Sex nut & thru-bolts – standard¹

(1) With fire model only. Required for fire-rated wood or composite doors and non-reinforced hollow metal doors. See DX1 Accessories, p. 19-21.

- Electrical Options***
- Alarm kit
 - Delayed egress
 - Electronic latch retraction
 - Request to exit
 - Signal switch
 - Electrical mortise lock

() Special order. See DX1 Electrical, p. 23-29.*

- Trims**
- Compatible trims sold separately, easy to mix and match - *See DX1 Trims, p. 13-18.*

- Finish**
- 630–Satin Stainless Steel
- Other finishes available by special order, see p. 4.*

Dogging

What is dogging?

Dogging is a feature used in exit devices to hold the push pad or crossbar in a retracted position (holding the latch retracted), thus allowing a door to operate in push/pull mode without latching.

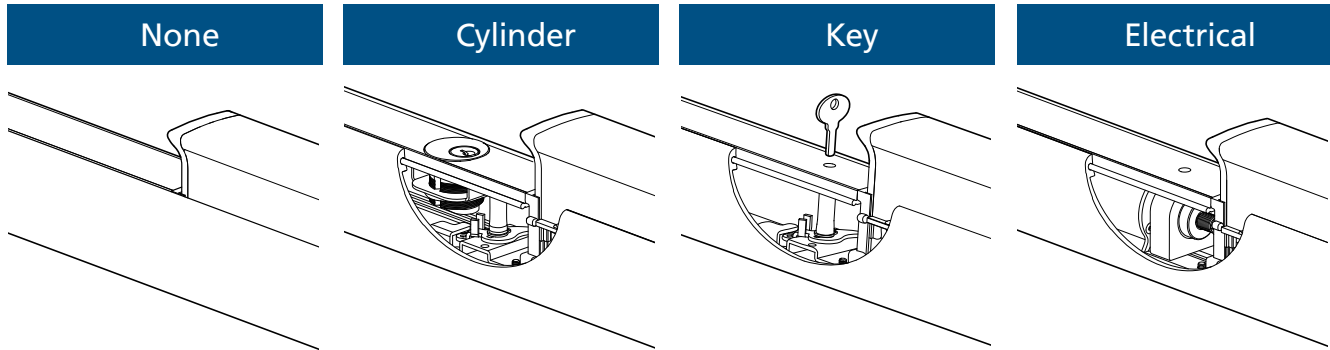

Less or No Dogging

Less Dogging is available for all DX1 exit devices.

Cylinder Dogging

Available for all models except for Fire Exit Hardware. Cylinder Dogging provides the ability to lock down the push bar with a key cylinder.

Requires the use of a 1 1/4" mortise cylinder that is not included and is sold separately.

DX1 Cylinder Dogging Kit
 (#DX1AKD3LC - for 3ft devices).
 (#DX1AKD4LC - for 4ft devices).

Key Dogging

Available for all models except for Fire Exit Hardware. Key dogging provides the ability to lock down the push bar with an included flat key or appropriately sized flat-headed screw driver.

A replacement key (#DXADK) is also available.

Electrical Dogging

Also known as Electrical Latch Retraction.

For details, see page 25.

Fire Door Applications and Listings

Maximum Door Opening Applications and Listings

Exit Device	Door Material	Single Door	Double Door			
			With mullion	2 Vertical Rods Same Direction	Vertical Rods / Mortise Same Direction	2 Vertical Rods Double Egress
DX1FR RIM	Metal	3 Hours 4' x 8'	3 Hours 8' x 8'			
DX1FV SVR	Metal	3 Hours 4' x 8'		3 Hours 8' x 8'	3 Hours 8' x 8'	3 Hours 8' x 8'
DX1FVL LBR	Metal	3 Hours 4' x 8'		3 Hours 8' x 8'		3 Hours 8' x 8'
DX1FC CVR	Metal	3 Hours 4' x 8'		3 Hours 8' x 8'	3 Hours 8' x 8'	3 Hours 8' x 8'
DX1FCL LBR	Metal	3 Hours 4' x 8'		3 Hours 8' x 8'		3 Hours 8' x 8'
DX1FM MORTISE	Metal	3 Hours 4' x 8'			3 Hours 8' x 8'	
DX1FW 3PT	Metal	3 Hours 4' x 8'	3 Hours 8' x 8'			

Metric conversion: 4' (1219 mm), 8' (2438 mm), 10' (3048 mm).

Notes:

1. Fire exit device conforms to UL10C, and UBC7-2.
2. Fire exit device is applicable for wood door with 1 1/2-hour or 20-min fire rating.
3. Consult with door manufacturer for specific limitations on fire door assemblies.

DX1

Trim Options



DX1TT Series
Thumb Piece



DX1TE Series
Escutcheon



DX1TP Series
Pull Handle

DX1TT Series Thumb Piece Trim



Features

- Trims are furnished with wrought plate and cast solid or forged grips.
- Trims are designed to retrofit into other manufacturers' devices.
- Trims are cULus certified for ANSI/BHMA A156.3-2014 Grade 1 and 3-hour Fire Exit Hardware.
- Trims are through bolted and covering 161 and 86 cutouts.
- Meets ADA requirements.
- Satin stainless steel (630) finish – other finishes available.
- Cylinder not included, see page 22.
- For Trim dimensions see page 6.
- To order, see page 30.

ANSI/BHMA	01	02	03		
					
Operation	Exit only, blank escutcheon.	Entrance by trim when actuating bar is locked down/dogged. (Dummy)	Entrance by trim when latch is released by key. Key removable only when locked. (Night Latch)		Latch released by key. Key removable only when locked. *Pull required (not included)
Trim No.	<i>DX1TTR 01*</i>	<i>DX1TTR 02*</i>	DX1TTR 03	<i>DX1TTM 03*</i>	Cylinder only *Not included - see p. 22
Cylinder Type			Rim	Mortise	Rim/Mortise
Device No.	DX1 PR/FR DX1 PV/FV DX1 PC/FC DX1 PW/FW DX1 PM/FM	DX1 PR/FR DX1 PV/FV DX1 PC/FC DX1 PW/FW DX1 PM/FM	DX1 PR/FR DX1 PV/FV DX1 PC/FC DX1 PW/FW		DX1 PR/FR DX1 PV/FV DX1 PC/FC DX1 PW/FW DX1 PM/FM

Lever / Grip Options

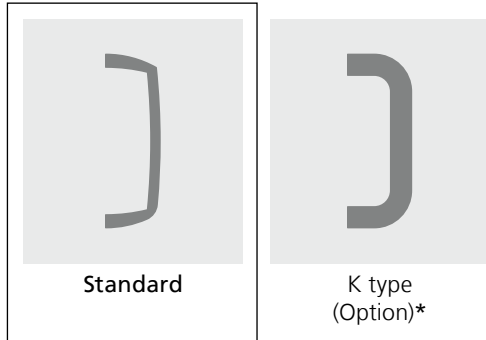

05 07		15	
Entrance by thumb piece. (Classroom) (05) Key locks or unlocks thumb piece. (07) Inside/outside key locks/unlocks thumb piece. Outside key releases latch. ¹		Entrance by trim when latch is released by thumb piece. Thumb piece always active, no cylinder. (Passage)	
DX1TTR 05	DX1TTM 05*	DX1TTR 15*	DX1TTM 15*
Rim	Mortise		
DX1 PR/FR		DX1 PR/FR	
DX1 PV/FV		DX1 PV/FV	
DX1 PC/FC		DX1 PC/FC	
DX1 PW/FW		DX1 PW/FW	
	DX1 PM/FM		DX1 PM/FM





(1) Double Cylinder

DX1TE Series Escutcheon Trim



Features

- Escutcheon and lever with sleek and seamless design produced by casting or forging.
- Trims are designed to retrofit into other manufacturers' devices.
- Trims are through bolted and covering 161 and 86 cutouts.
- Handing field reversible.
- Trims are cULus certified for ANSI/BHMA A156.3-2014 Grade 1 and 3-hour Fire Exit Hardware.
- Meets ADA requirements.
- Satin chrome (626) finish – other finishes available.
- Cylinder not included, see page 22.
- For Trim dimensions see page 6.
- To order, see page 30.

ANSI/BHMA	02	08 10	
			  <p>Breakable Cam</p> <p>The DX1TER/ITEM (Functions 08, 10 only) includes an internal breakable cam which breaks when a predetermined load is applied to the outside lever handle when locked without damaging the trim or compromising security. The cam can easily be replaced - #DXACED03.</p>
Operation	Entrance by trim when actuating bar is locked down/dogged. (Dummy)	Entrance by knob or lever. (Storeroom) (08) Key locks or unlocks latch. (10) Inside or outside key locks/unlocks latch. Outside key releases latch. ¹	
Trim No.	DX1TER 02*	DX1TER 08 ²	DX1TEM 08 ²
Cylinder Type		Mortise	Mortise
Device No.	DX1 PR/FR DX1 PV/FV DX1 PC/FC DX1 PW/FW DX1 PM/FM	DX1 PR/FR DX1 PV/FV DX1 PC/FC DX1 PW/FW	DX1 PM/FM

(1) Double Cylinder (2) Clutch function available by special order.

Lever Options

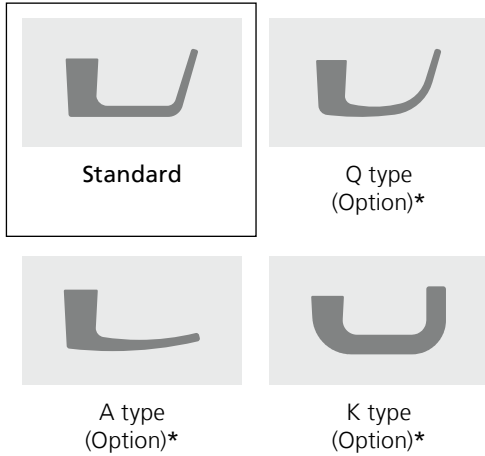

Knob Options

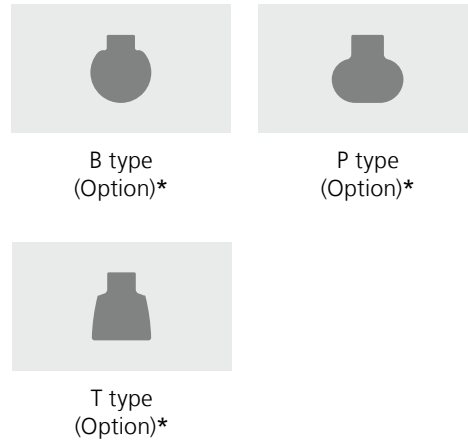

09		14		08
Entrance by knob/lever only when released by key. Key removable only when locked. (Night Latch)		Entrance by trim when latch is released by knob/lever. Always active, no cylinder. (Passage)		Entrance by pull tab. Key locks/unlocks the pull tab. (Classroom)
DX1TER 09	DX1TEM 09	DX1TER 14	DX1TEM 14	DX1THM 08*
Rim	Mortise			Mortise
DX1 PR/FR		DX1 PR/FR		
DX1 PV/FV		DX1 PV/FV		
DX1 PC/FC		DX1 PC/FC		
DX1 PW/FW		DX1 PW/FW		
	DX1 PM/FM		DX1 PM/FM	DX1 PM/FM





Indicate handing when ordering.

DX1TP Series Pull Handle



Features

- For application with existing DX1 Series Exit Devices.
- Ease of installation.
- Non-handed.
- Trims are cULus certified for ANSI/BHMA A156.3-2014 Grade 1 and 3-hour Fire Exit Hardware.
- Meets ADA requirements.
- Satin stainless steel (630) finish – other finishes available.
- Cylinders not included, see page 22.
- For Trim dimensions see page 6.
- To order, see page 30.

ANSI/BHMA	02	08	09	14
				
Operation	Entrance by trim when actuating bar is locked down/dogged. (Dummy)	Entrance by pull handle. Key locks or unlocks pull grip. (Classroom)	Entrance by pull handle only when released by key. Key removable only when locked. (Night Latch)	Entrance by trim when latch is released by pull handle. Always active, no cylinder. (Passage)
Trim No.	<i>DX1TPR 02*</i>	DX1TPR 08 <i>DX1TPM 08*</i>	DX1TPR 09 <i>DX1TPM 09*</i>	DX1TPR 14 <i>DX1TPM 14*</i>
Cylinder Type		Mortise	Mortise	
Device No.	DX1 PR/FR DX1 PV/FV DX1 PC/FC DX1 PW/FW DX1 PM/FM	DX1 PR/FR DX1 PV/FV DX1 PC/FC DX1 PW/FW	DX1 PR/FR DX1 PV/FV DX1 PC/FC DX1 PW/FW DX1 PM/FM	DX1 PR/FR DX1 PV/FV DX1 PC/FC DX1 PW/FW DX1 PM/FM

Accessories

Rim Device - Strikes

P Panic Application
🔥 Fire Application

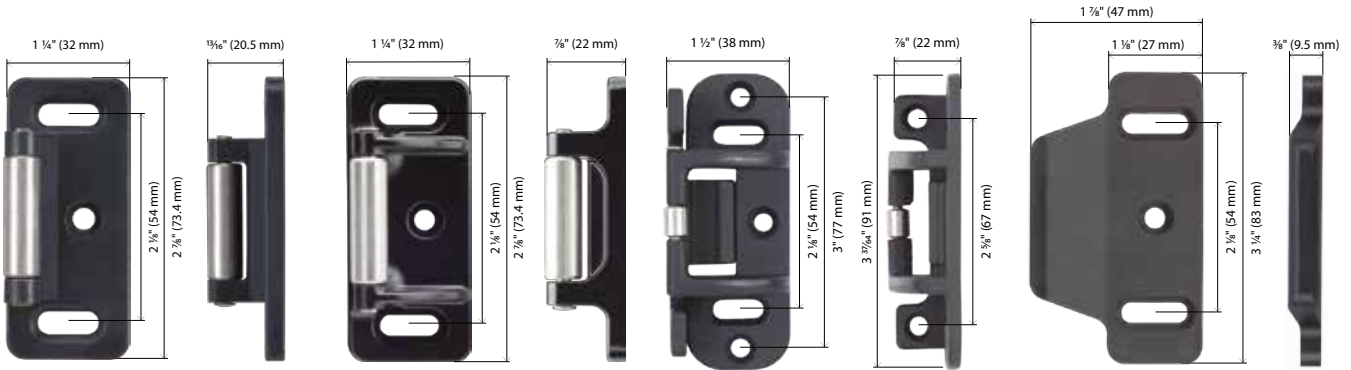

P/N. DXAS106
Rim Strike
 Middle strike for DX1PR, DX1PW. Top Strike for DX1PV, DX1PW.

P

P/N. DXAS106Z*
Rim Strike
 Optional for DX1PR. Top Strike for DX1PV, DX1PW.

P

P/N. DXAS108F
Rim Strike with Strike Hook
 Middle strike for DX1FR and DX1FW. Top Strike for DX1FV, DX1FW. For double door DX1FR/PR or DX1FW/PW with mullion.

P **🔥**

P/N. DXAS136*
Overlapping Rim Strike
 For DX1PR or DX1PW paired with DX1PV or DX1PC in double door applications with door coordinator and no mullion.

P

Vertical Rod (VR) Device - Strikes

Top Strike

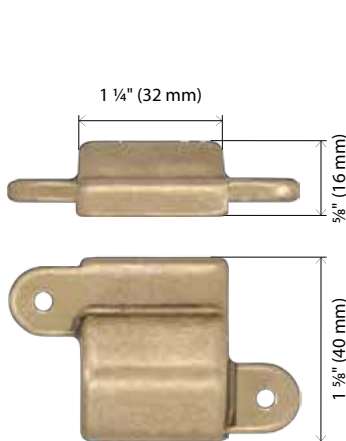

P/N. DXAS216
Top Strike
 For DX1PC/FC.

P **🔥**

Bottom Strike – Pullman

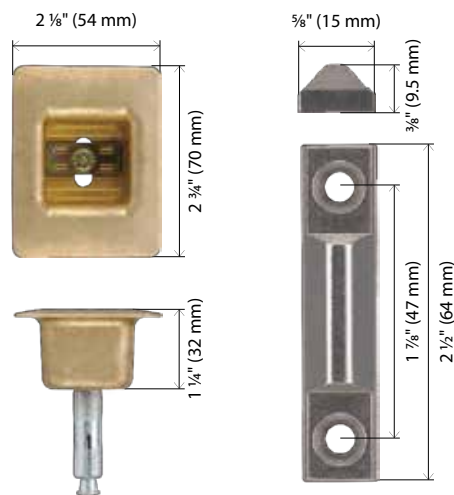

P/N. DXAS227/227F
Bottom Strike
 Standard for DX1PV/FV; DX1PC/FC, DX1PW/FW.

P **🔥**

Bottom Strike - Round



P/N. DXAS224*
Bottom Strike
 Optional for DX1PV and DX1PW. (Grade 2)

P

P/N. DXAS225*
Bottom Strike
 For DX1PV, DX1PC, DX1PW with round slide bolt. (Grade 2)

P

P/N. DXAS226*
Bottom Strike
 Optional for DX1PV, DX1PC, DX1PW with round slide bolt. (Grade 2)

P

Accessories

P Panic Application
F Fire Application

Mortise Device - Strikes

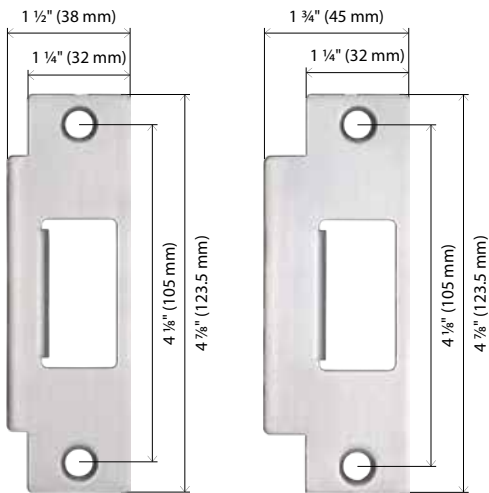

P/N. DXAS336*
Strikes
 For use on 1 3/4" (45 mm) thick double door with coordinator and astragal.



P/N. DXAS306
Strikes
 Standard for use on 1 3/4" (45 mm) or 2 1/4" (57 mm) single door and 2 1/4" (57 mm) double door with coordinator.



Shims



P/N. DXKG6030*
 For DXAS108 Rim Strike.
 Two (2) pieces furnished standard.



P/N. DXKG6050*
 For DX1PC/FC top & bottom latches.
 Sixteen (16) pieces furnished standard for Top and Bottom latches. Eight (8) pieces furnished standard for LBR.



P/N. DXKG6010*
 For DXAS106 Rim Strike.
 Two (2) pieces furnished standard.



P/N. DXKCVR14AC
 For DX1PC/FC. For 2" (50 mm) aluminum doors with 1/4" (6.4 mm) cladding.

Fastener/Sex Nut Bolts (SNB)

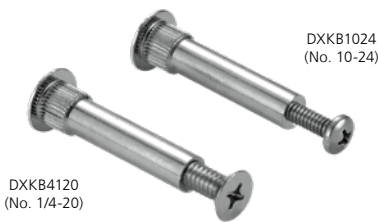

Specify Sex Nut Bolts (SNB) where recommended or when required by the door manufacturer.

Sex Nuts Bolts (SNB) are furnished with DXKB1024 (No. 10-24) for device or DXKB4120 (No. 1/4-20) for top rod latch and bottom rod latch. Can accommodate doors up to 2 1/4" (57 mm) thick.

	Device	Specification	Qty.
Without Trim	DX1PR/FR	DXKB1024 (No. 10-24)	8
	DX1PV/FV	DXKB1024 (No. 10-24)	6
		DXKB4120 (No. 1/4-20)	4
	DX1PC/FC DX1PM/FM	DXKB4120 (No. 10-24)	6
With Trim	DX1PW/FW	DXKB1024 (No. 10-24)	6
		DXKB4120 (No. 1/4-20)	4
	DX1PR/FR	DXKB1024 (No. 10-24)	2
	DX1PV/FV	DXKB1024 (No. 10-24)	2
		DXKB4120 (No. 1/4-20)	4
	DX1PC/FC DX1PM/FM	DXKB1024 (No. 10-24)	2
	DX1PW/FW	DXKB1024 (No. 10-24)	2
		DXKB4120 (No. 1/4-20)	4

Auxiliary Fire Bolt/Latch





P/N. DXAFL
 Heat activated. Used in Less Bottom Rod (L) option for fire exit devices. Included when ordering Less Bottom Rod (L) option.
 For door openings up to (WXH) 8x8 ft.



Accessories

Top Rods

	Part No.	Rod Length	
	DXAVRT020	36 $\frac{1}{8}$ " (916 mm)	Surface rod included with size 37 exit device
	DXAVRT030	48 $\frac{1}{8}$ " (1221 mm)	Surface rod included with size 48 exit device
	DXAVRT040	24" (609 mm)	Extension rod, surface
	DX1ACRT070	37" (940 mm)	Concealed rod included with size 37 exit device
	DX1ACRT080	49" (1245 mm)	Concealed rod included with size 48 exit device
	DX1ACRT050	23 $\frac{7}{8}$ " (605 mm)	Extension rod, concealed



Top Rod Selection Guide

Door Width	Door Height	Device Size	Additional Surface Rod	Additional Concealed Rod
36in (914 mm)	7ft (213 cm)	37	none	none
36in (914 mm)	8ft (244 cm)	37	DXAVRT030 ²	DXACRT080 ²
36in (914 mm)	9ft (274 cm) ¹ , 10ft (305 cm) ¹	37	DXAVRT030 ² + DXAVRT040 ³	DXACRT080 ² + DXACRT050 ³
48in (1219 mm)	7ft (213 cm)	48	none ³	none ³
48in (1219 mm)	8ft (244 cm)	48	none	none
48in (1219 mm)	9ft (274 cm) ¹ , 10ft (305 cm) ¹	48	DXAVRT040 ³	DXACRT050 ³

(1) Not for use with fire-rated devices. (2) Replace included top rod. (3) Top rod may need to be cut and/or tapped to fit.

Bottom Rods



For exit device location at 39 $\frac{5}{8}$ " (1006 mm) from finished floor

	Part No.	Rod Length	
	DXAVRB010	31 $\frac{1}{8}$ " (807 mm)	Included with DX1 PV/FV DX1 FW/FW
	DX1ACRB010*	34 $\frac{9}{32}$ " (870 mm)	Included with DX1 PC/FC

Cylinders

Cylinders are not furnished standard with the device or trim and must be specified when required. Cylinders are Schlage® C keyway, 6-pin standard, and are available in satin chrome (626) finish. Interchangeable Cores (SFIC) are also available.

Please consult your local sales representative prior to specifying to ensure proper selection or for additional keying services.

Cylinder Type	Trim	Exit Device Applications	Cylinder	Cyl. Length (Part/no.)	Cylinder Cam
 Mortise Cylinder SFIC Standard	DX1 TT	03* / 05* / 07 for DX1 PM/FM	Standard	1 $\frac{3}{8}$ " (MC138†)	DXAC A
		08 for DX1PR/FR, DX1PV/FV, DX1PC/FC, DX1PW/FW	SFIC	1 $\frac{3}{8}$ " (DXAICMH138J†)	J**
	DX1 TE	08 / 09 for DX1 PM/FM	Standard	1 $\frac{1}{8}$ " (MC118)	DXAC B
		08 for All Devices	SFIC	1 $\frac{3}{8}$ " (DXAICMH138F†)	F**
	DX1 TP	09 for All Devices	Standard	1 $\frac{5}{8}$ " (DM00X-PE225CYL)	DXAC A
		09 for All Devices	SFIC	DXAICMHJ† (See note 1)	J**
All Devices	Cylinder Dogging or Electrified Function	Standard	1 $\frac{1}{8}$ " (MC118)	DXAC D	
		SFIC	1 $\frac{3}{8}$ " (DXAICMH138H†)	H**	
 Rim Cylinder SFIC Standard	DX1 TT	03* / 05* for DX1PR/FR, DX1PV/FV, DX1PC/FC, DX1PW/FW	Standard	2 $\frac{3}{8}$ " Tailpiece (MR118)	DXACC
			SFIC	3 $\frac{1}{8}$ " Tailpiece (9807H)	G**
	DX1 TE	09 for DX1PR/FR, DX1PV/FV, DX1PC/FC, DX1PW/FW	Standard	1 $\frac{1}{4}$ " (MC114)	DXAC A
			SFIC	1 $\frac{3}{8}$ " (DXAICMH138G†)	G**
	All Devices	Cylinder Dogging or Electrified Function	Standard	1 $\frac{1}{4}$ " (MC114)	DXAC A
			SFIC	1 $\frac{3}{8}$ " (DXAICMH138J†)	J**

Note 1. For door thicknesses 1 $\frac{3}{4}$ –1 $\frac{7}{8}$ " (45–48mm) use a 1 $\frac{1}{2}$ " cylinder (DXAICMH112J). For door thicknesses 1 $\frac{7}{8}$ –2 $\frac{1}{4}$ " (48–57 mm) use a 1 $\frac{3}{4}$ " cylinder (DXAICMH134J). Please contact your representative for details.

* Must use with Cylinder Collar (Part/No. 817D). ** Fixed cam, not available separately.

† Special order - will require additional lead time and/or minimum order quantities.

Cylinder Cam

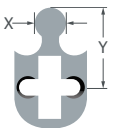
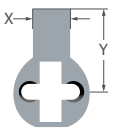
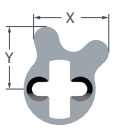
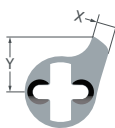
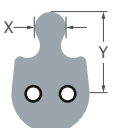
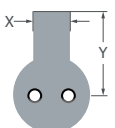
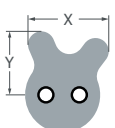
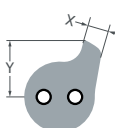
Cam No.	DXAC A	DXAC B	DXAC C	DXAC D
Illustration				
Cam No.	J**	F**	G**	H**
Illustration				
Dimension	X=0.250" (6mm) Y=0.625" (15mm)	X=0.375" (9.5mm) Y=0.750" (19mm)	X=0.625" (16.4mm) Y=0.563" (13.6mm)	X=0.1875" (4.4mm) Y=0.4375" (11.9mm)

** Fixed cam, not available separately.

Cylinder Collar



P/N : 817D
For use on DX1TT 03 / 05 / 07 Thumb Piece Trim.

DX1PC/FC with DX1TER08 Escutcheon Trim and DX1PM/FM Escutcheon Trim require specialized cylinder collars.

For special door thickness applications and specification details, please contact your local sales representative.

SFIC Core



Interchangeable cores are included with housings. Specify, 6 or 7 pin, uncombined (0-bitted) or less core. Please contact your local sales representative for details and keying services.

Electrified



EL

Electric Latch Retraction / Dogging

Electric Latch Retraction / Dogging (EL) provides the ability to retract the exit device latch. When a signal is sent to the device, either from a reader or from some other electric signal switch, the latch is retracted momentarily allowing the door to be pulled open.

The latch can also be held retracted for a longer period (electric dogging). This can be set up with the access control system so that the device is on a schedule. At the beginning of the day the latch can be retracted and held open for business hours and then released and secure for closing time at the end of the day.

The DX1 EL uses a solenoid to retract and hold the latch. When power is cut during a power failure, the solenoid releases the latch to secure the opening (Fail Secure).

A power supply and wire transfer are required (sold separately).

Features:

- cULus Listed for Panic and Fire Exit Hardware.
- Panic model includes manual flat key dogging.
- Available configurations include:
 - » with Latch Monitoring switch (ELM)
 - » with Signal Switch (ELS)
 - » with Request-To-Exit switch (ELR)
 - » with Request-To-Exit and Latch Monitoring switches (ELX)

See installation instructions for wiring diagrams.

Solenoid Specifications:

- Current (In Rush - 0.3 seconds): 24VDC, 16 A
- Current (Continuous): 24VDC, 0.25 A

Availability:

- For all DX1 Exit Devices.

To order:

- See How To Order, p. 30.



Electrified



SS

Signal Switch

Uses a micro switch built into the exit device to monitor the push bar assembly of the device. When pressed, the exit device will sound an alarm and send a signal to any other connected device or system.

The keyed mortise cylinder activates or deactivates the signal switch function. Mortise cylinder is a standard $1\frac{1}{32}$ " (29.4mm) diameter cylinder, $1\frac{1}{4}$ " (31.7 mm) long, with a straight cam (DXACA) - refer to page 22 for details.

A power supply and wire transfer are required (sold separately).

EMERGENCY EXIT • **SORTIE DE SECOURS**
PUSH TO OPEN & SOUND ALARM PUSSEZ POUR OUVRIR ET SONNER L'ALARME

Push bar label.

Features:

- cULus Listed for Panic and Fire Exit Hardware.
- Keyed mortise cylinder not included, see p. 22
- Push bar label included.

See installation instructions for wiring diagrams.

Specifications:

- Switch Rate: 24VDC, 2A (per switch)
(SPDT – Single Pole, Double Throw)

Availability:

- For all DX1 Exit Devices.

To order:

- See How To Order, p. 30.



Electrified

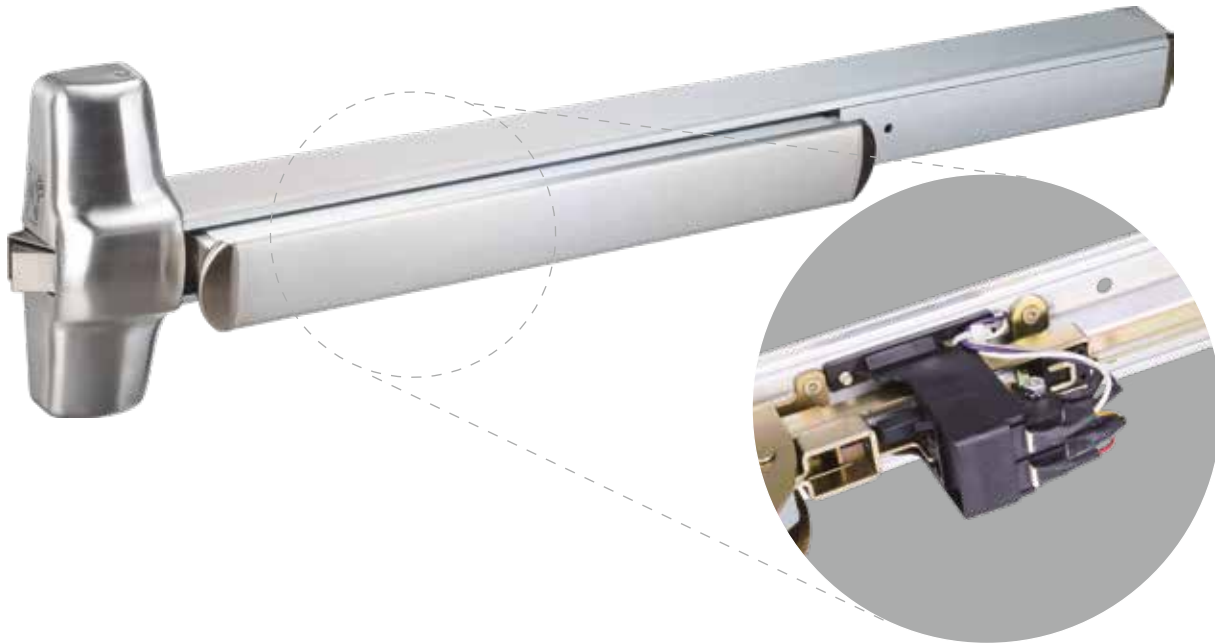

RX

Request to Exit

Uses a micro switch built into the exit device to monitor the push bar assembly of the device. When pressed, the exit device will send a signal to a centralized system, electric strike, electromagnetic lock, or other connected electrified device requiring a Request-To-Exit input.

A power supply and wire transfer are required (sold separately).

Request-to-Exit with Latch Monitoring switch (RXM) also available.

Features:

- cULus Listed for Panic and Fire Exit Hardware.

See installation instructions for wiring diagrams.

Specifications:

- Switch Rate: 24VDC, 3A
(SPDT – Single Pole, Double Throw)

Availability:

- For all DX1 Exit Devices.

To order:

- See How To Order, p. 30.



LM

Latchbolt Monitoring

Uses a micro switch built into the exit device to monitor the latchbolt of the device. When pressed or released, the monitor switch will send a signal to a centralized system, electric strike, electromagnetic lock, or other connected electrified device requiring an input.

A power supply and wire transfer are required (sold separately).

Features:

- cULus Listed for Panic and Fire Exit Hardware.

See installation instructions for wiring diagrams.

Specifications:

- Switch Rate: 24VDC, 3A
(SPDT – Single Pole, Double Throw)

Availability:

- For all DX1 Exit Devices.

To order:

- See How To Order, p. 30.



Electrified

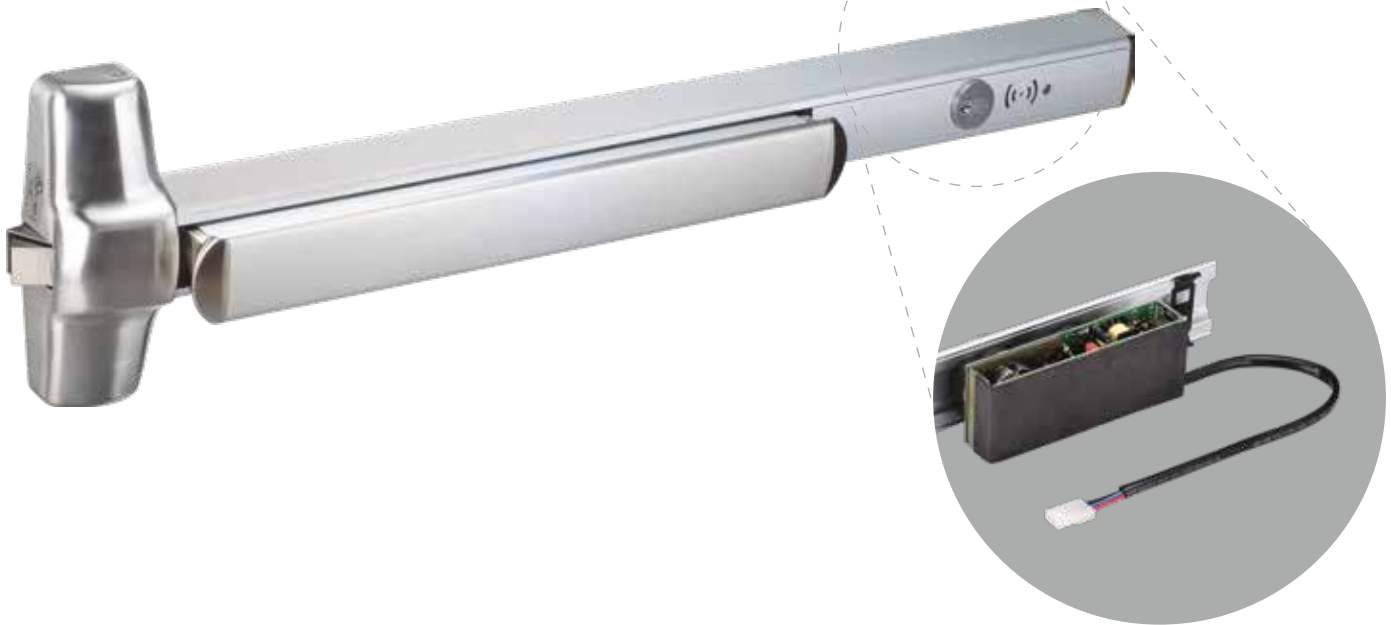

DE

Delayed Egress Device

DX1 exit devices that are installed with the delayed egress (DE) function are used when an emergency exit needs to be delayed for a short time. This is usually done to allow security personnel to verify if the person attempting to exit should be using that exit or not.

When someone pushes against the push bar, a signal will be sent to a connected security system or device, an alarm will sound, and a timer will begin to countdown from 15 (or 30) seconds. After the time has expired the device will allow passage through the opening.

The keyed mortise cylinder activates/deactivates or rearms the DE function. Cylinder is not included, sold separately. Refer to page 22 for details.

A power supply and wire transfer are required (sold separately).

Operation Example: When locked, the exit device LED indicator is on. Depressing the push bar by accident, for less than the nuisance delay time, will sound the audio alarm without initiating the alarm sequence. Depressing the push bar with less than 15 pounds pressure, for longer than the nuisance delay time, will initiate an irreversible local audible beeping tone and the LED indicator will flash until the device releases. After the 15 second delay time, the lock releases and the alarm changes to a steady tone which continues to sound until reset. The remote monitoring contact output on the device can be used to alert security personnel.

Features:

- ULus Listed for Panic and Fire Exit Hardware (US only).
- Nuisance delay to prevent accidental activation.
- LED lock status light.
- Keyed mortise cylinder not included, see p. 22
- Door label (15 seconds) included.
- 30 Second delay model available (DE3).

See installation instructions for wiring diagrams.

Specifications:

- Current (In Rush): 24VDC, 16A, 0.3 seconds
- Current (Continuous): 24VDC, 0.37A

Availability:

- For all DX1 Exit Devices.

To order:

- See How To Order, p. 30.



PUSH UNTIL ALARM
DOOR CAN OPEN IN 15 SECONDS
POUSSER JUSQU'À L'ALARME
PORTE PEUT OUVRIR EN 15 SECONDES

Door label.

Electrified Trim



Electrified Escutcheon Trim

The DX1ETE electrified escutcheon trim can be tied to any DX1 exit device and will connect with access control readers, keypads, buttons, or other such systems. They are equipped with a solenoid that locks or unlocks the trim only, no built-in monitoring.

Trims are factory set to either Fail Secure (FL) or Fail Safe (FU) and are field configurable. Please indicate when ordering.

Features:

- cULus Listed for Panic and Fire Exit Hardware.
- Rim/Mortise cylinder is not included, sold separately.



See installation instructions for wiring diagrams.

Specifications:

- Current: 24VDC, 0.25A
12VDC, 0.5A (option)

Availability:

- For all DX1 Exit Devices.

To order:

- See How To Order, p. 30.

DX1ETE Series

ANSI/BHMA	09		14	
Operation	Electrified trim with integrated lock/unlock option. Entrance by lever only when released by key or electrical signal. Key removable only when locked. (Night Latch)		Electrified trim with integrated lock/unlock option. Entrance by trim when latch is released by electrical signal.	
Trim No.	DX1ETER 09*	DX1ETEM 09*	DX1ETER 14*	DX1ETEM 14*
Cylinder Type	RIM	Mortise		
Device No.	DX1 PR/FR		DX1 PR/FR	
	DX1 PV/FV		DX1 PV/FV	
	DX1 PC/FC		DX1 PC/FC	
		DX1 PM/FM		DX1 PM/FM
	DX1 PW/FW		DX1 PW/FW	

Electrified Lock

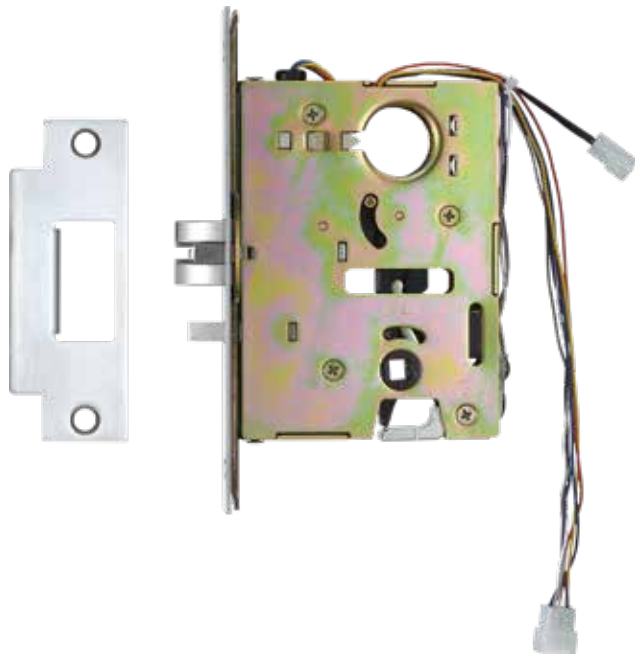

Electrified Mortise Lock

The Electric Mortise (EM) exit device includes an electrified ANSI mortise lock that can remotely lock/unlock the exterior trim and/or monitor the auxiliary latch status through a SPDT signal.

Installations must include an exterior trim with a night latch function (09).

There are two models:

- **DX1 EM:** Includes an electrified mortise lock (DX1M-7000) which can allow remote locking / unlocking of the exterior trim using a solenoid. It will also monitor the latch bolt, and lock/unlock status of the exterior trim. See wiring diagram below.
- **DX1 EMS:** Includes an electrified mortise lock (DX1M-SS7000) which **ONLY MONITORS** both the auxiliary latch and the lock/unlock status of the exterior trim. See wiring diagram below.

Both electrified locks are factory set to Fail Secure (FL); when power is cut off, the trim remains locked. Power must be applied to unlock the trim. They can be field converted to Fail Safe (FU); when power is cut, the trim unlocks. Power must be applied to lock the trim

Features:

- cULus Listed for Panic and Fire Exit Hardware.
- Rim/Mortise cylinder is not included, sold separately.



See installation instructions for wiring diagrams.

Specifications:

- Current: 24VDC, 0.25A
12VDC, 0.5A (option)
- Switch Rate: 24VDC, 2A
(SPDT – Single Pole, Double Throw)

Availability:

- Only DX1PM, DX1FM exit devices.

To order:

- See How To Order, p. 30.

DX1 EM:

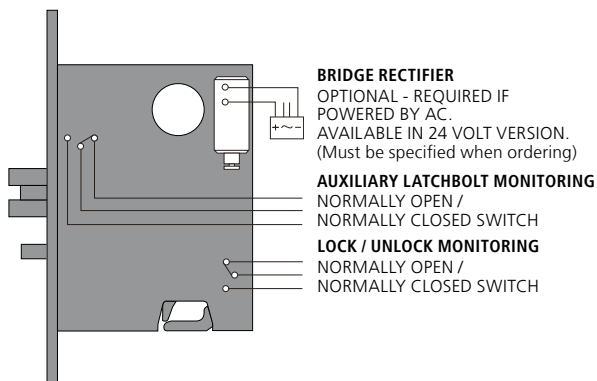

DX1 EMS:

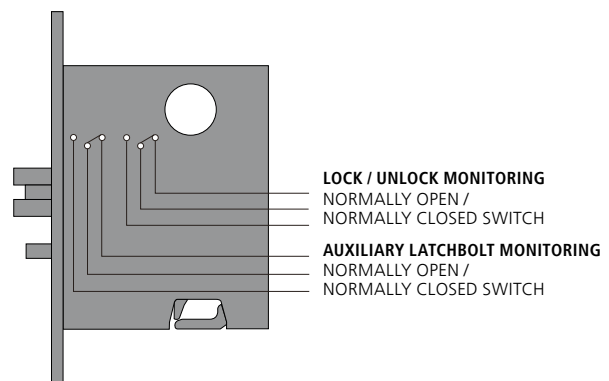

How To Order

EXIT DEVICE

DX	1	AL	P	V	L	37	C	-	630	H	
SERIES	STYLE	ELECTRIC	RATING	TYPE	ROD/LATCH	SIZE	HAND	DOGGING	FINISH	STRIKE	
<p>BLANK = NOT REQUIRED (IE: DUMMY) 1 - WIDE HEAD, SMOOTH SURFACE G1 - WIDE HEAD, GROOVED SURFACE* SEE P.4</p>						<p>3 - 3FT DEVICE 4 - 4FT DEVICE 37 - 3FT DEVICE, 7FT DOOR* 48 - 4FT DEVICE, 8FT DOOR* FOR TALLER DOORS SEE P.21</p>					
<p>BLANK = NOT REQUIRED AL - ALARM EXIT (RX)* AM - ALARM EXIT (LM)* AX - ALARM EXIT (LM+RX)* ALA - ALARM EXIT (RX) AUTO-RESET* AMA - ALARM EXIT (LM) AUTO-RESET* AXA - ALARM EXIT (LM+RX) AUTO-RESET* DE - DELAYED EGRESS (15 SEC)* DE3 - DELAYED EGRESS (30 SEC)* EM12 - ELEC. MORTISE 12V* EMS12 - ELEC. MORTISE 12V (SS)* EM - ELEC. MORTISE 24V* EMS - ELEC. MORTISE 24V (SS)* EL - ELEC. LATCH RETRACTION* ELR - ELEC. LATCH RET. (+RX)* ELS - ELEC. LATCH RET. (+SS)* ELM - ELEC. LATCH RET. (+LM)* ELX - ELEC. LATCH RET. (+LM+RX)* LM - LATCHBOLT MONITORING* RX - REQUEST TO EXIT* RXM - REQUEST TO EXIT (+LM)* SS - SIGNAL SWITCH* SEE P.23-29</p>		<p>P - PANIC EXIT F - FIRE EXIT</p>		<p>R - RIM V - SURFACE VERTICAL ROD C - CONCEALED VERTICAL ROD M - MORTISE W - 3 POINT D - DUMMY, INACTIVE* DA - DUMMY, ACTIVE* SEE P.7-11</p>		<p>BLANK = NOT REQUIRED LHRC - LEFT HAND REV., CYLINDER* (CYL INCL.) RHRC - RIGHT HAND REV., CYLINDER* LHRT - LEFT HAND REV., THUMB TURN* RHRT - RIGHT HAND REV., THUMB TURN* REQUIRED FOR DOUBLE CYLINDER FUNCTIONS</p>		<p>BLANK = (PANIC DEFAULT) HEX KEY DOGGING (FIRE DEFAULT) LESS DOGGING C - CYLINDER DOGGING* (CYLINDER NOT INCLUDED) L - LESS DOGGING*</p>		<p>630 - SATIN STAINLESS STEEL (32D) 626 - SATIN CHROME (26D)* 625 - POLISHED CHROME (26)* 613 - OIL RUBBED BRONZE (10B)* 612 - SATIN BRONZE (10)* 611 - POLISHED BRONZE (9)* 606 - SATIN BRASS (4)* 605 - POLISHED BRASS (3)* SEE P.4</p>	
				<p>BLANK = NOT REQUIRED OR DEFAULT (PULLMAN LATCH) L - LESS BOTTOM ROD* R - ROUND BOTTOM LATCH*</p>				<p>BLANK = DEVICE DEFAULT (SEE P.7-11) A - DXA106 H - DXA226* B - DXA108 J - DXA227/227F C - DXA136* K - DXA306 E - DXA216 L - DXA336* F - DXA224* M - DXA337* G - DXA225* N - DXA338* SEE P.19-20</p>			

DEVICE TRIM

DX	1	E	TE	R	A	09	LHR	SC	KD	6	-	FL	-	630
SERIES	STYLE	ELECTRIC	TRIM	DEVICE	DESIGN	FUNCTION	HANDING	KEYWAY	KEYING	PINS	FEATURE	FINISH		
<p>1 - WIDE HEAD DEVICE</p>														
<p>BLANK = NOT REQUIRED E - ELECTRIC TRIM (TE ONLY)* SEE P.28</p>		<p>TT - THUMB PIECE TRIM TE - ESCUTCHEON TRIM TP - PULL HANDLE TRIM TH - PULL LATCH TRIM (HANDED)* SEE P.13-18</p>		<p>R - RIM, VERTICAL OR 3-POINT M - MORTISE EXIT DEVICE</p>				<p>BLANK = NOT REQUIRED KD - KEYED DIFFERENT KA - KEYED ALIKE* KA2 - KEYED ALIKE, PAIR*</p>		<p>BLANK = NOT REQ. 5 - 5 PINS* 6 - 6 PINS 7 - 7 PINS*</p>		<p>BLANK = N/A FU12 - FAIL-UNLOCKED 12V* FL12 - FAIL-LOCKED 12V* FU - FAIL-UNLOCKED 24V* FL - FAIL-LOCKED 24V* SEE P.28</p>		
		<p>BLANK = DEFAULT STYLE K - THUMB PIECE GRIP K* Q - ESCUTCHEON LEVER Q* A - ESCUTCHEON LEVER A* K - ESCUTCHEON LEVER K* B - ESCUTCHEON KNOB B* P - ESCUTCHEON KNOB P* T - ESCUTCHEON KNOB T* SEE P.13-18</p>		<p>01 - TT / BLANK PLATE* 02 - TT / DUMMY (PULL)* 03 - TT / NIGHT LATCH 05 - TT / CLASSROOM 15 - TT / PASSAGE* 02 - TE / DUMMY (LEVER)* 08 - TE / CLASSROOM 08D - TE / CLASSROOM, INSIDE KEY* (DBL CYLINDER) 09 - TE / NIGHT LATCH 14 - TE / PASSAGE 02 - TP / DUMMY (PULL)* 09 - TP / NIGHT LATCH 08 - TP / CLASSROOM 14 - TP / PASSAGE 08 - TH / CLASSROOM* SEE P.13-18</p>		<p>BLANK = NOT REQUIRED SC - SCHLAGE C IA - SFIC A* IAZB - SFIC A, 0-BITTED* IALC - SFIC A, LESS CORE* DUM - DUMMY SEE P.22</p>		<p>BLANK = (RHR) RIGHT HAND REV. BY DEFAULT LHR - LEFT HAND REV.</p>		<p>630 - SATIN STAINLESS STEEL (32D) 626 - SATIN CHROME (26D)† 625 - POLISHED CHROME (26)* 613 - OIL RUBBED BRONZE (10B)* 612 - SATIN BRONZE (10)* 611 - POLISHED BRONZE (9)* 606 - SATIN BRASS (4)* 605 - POLISHED BRASS (3)* (†) TE TRIM ONLY</p>				

* SPECIAL ORDER - WILL REQUIRE ADDITIONAL LEAD TIME AND/OR MINIMUM ORDER QUANTITIES.



Warranty

DOREX warrants to the original purchaser that all products provided by it shall be free of defects in material and workmanship regarding Mechanical Exit Devices & Trims (5 years), Electrified Products (1 year) and finishes (1 year). The present warranty does not cover scratches, abrasions, deterioration due to the use of paints, solvents and other chemicals, normal wear and tear, abuse or any damage caused by improper installation or misuse of the product. Furthermore, the cost incurred in removing a defective product and installing a replacement product is not included in the warranty. Upon return of a defective product, DOREX may repair or replace the product.

Note: The warranty becomes effective from the date of shipment.



CAUTION: Any retrofit or other field modification to a fire-rated opening can potentially impact the fire rating of the opening, DOREX makes no representations or warranties concerning what such impact may be in any specific situation. When retrofitting any portion of an existing fire rated opening, or specifying and installing a new fire-rated opening, please consult with a code specialist or local code official (Authority having jurisdiction) to ensure compliance with all applicable codes and ratings.

It is important that only DX1 strikes and latches be used with DX1 exit devices. The use of third party or previously installed strikes is not recommended and may hamper performance and/or invalidate hardware certifications. As above, please consult with a code specialist or local code official (Authority having jurisdiction) to ensure compliance with all applicable codes and ratings.

DOREX[®]





- Certifications**
- Certified ANSI/BHMA A156.3, Grade 1
 - cULus listed, Panic Exit
 - cULus listed, up to 3hr Fire Exit
 - Meets ADA/ANSI A117.1 for accessible operation
 - Meets California Building Code Sec. 11B-309.4
 - 10 Year limited warranty

- Rail Assembly**
- Steel rail assembly
 - Stainless steel assembly (32D finish)
 - Field sizable

- Handing**
- Non-handed

- Door Width**
- 30–38" (762–965 mm)
 - 36–48" (914–1219 mm) – option

- Door Height**
- Panic Exit: 120" (3048 mm) maximum
 - Fire Exit: 96" (2438 mm) maximum

- Door Thickness**
- 1 3/4" (45.5 mm)
 - 2 1/4" (57 mm) – available*

(* Requires #9500KB363, see Parts & Accessories

- Stile Width**
- 4 1/2" (114 mm) minimum
- Measured from door edge*

- Projection**
- 2 1/2" (64 mm) from door surface

- Latchbolt**
- Stainless steel, 3/4" (19 mm) throw

- Strike**
- 9500PR: Steel, standard type #9500AS239
 - 9500FR: Steel, standard type #9500AS245

Other strikes available

- Dogging**
- For Panic Exit models only
 - Hex key dogging
 - Cylinder dogging¹ – available

(1) See 9500 Trims & Accessories

- Mounting Hardware**
- Machine and wood screws
 - Sex nut & thru-bolts¹ – available
 - Glass bead shim kit – available

(1) Included with 9500FR. Required for non-reinforced hollow metal doors.

- Electrical Options**
- Electric latch retraction – option
 - Alarm kit – available*
 - Request to exit – available*

(Sold separately, see 9500 Trims & Accessories*

- Trims**
- Lever, knob, pull, plate, escutcheon and handleset trims available

Sold separately, see 9500 Trims & Accessories

- Finish**
- 19–Matte black, painted; 28–Aluminum, painted; 32D–Satin Stainless Steel

Other finishes available by special order

9500PR	3	–	28
MODEL ¹	SIZE ¹		FINISH

(1) SEE SELECTION GUIDE

SELECTION GUIDE

MODEL		SIZE	DOOR WIDTH ¹	DOGGING	FINISH	/ CASE
9500PR	Panic Exit Hardware Rim device	3	30-38 (762-965)	●	19, 28, 32D	4
		4	36-48 (914-1219)	●	28, 32D	4
9500FR	Fire Exit Hardware ² Rim device	3	30-38 (762-965)	—	19, 28, 32D	4
		4	36-48 (914-1219)	—	28, 32D	4

(1) RECOMMENDED DOOR WIDTH, IN (MM), FOR NON-STANDARD SIZES OR INSTALLATIONS PLEASE CONTACT. (2) FIRE EXIT HARDWARE MUST BE INSTALLED ON FIRE EXIT LABELLED DOORS.

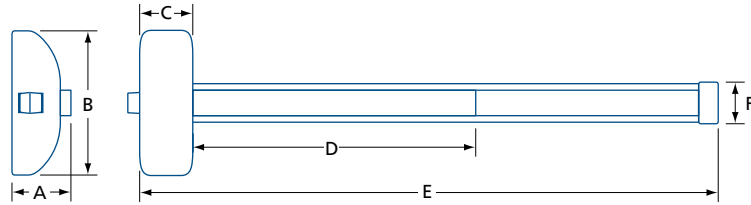

MODEL	A	B	C	D	E ¹	F
9500PR3 / FR3	2 1/2 (64)	7 11/16 (196)	2 11/16 (68)	21 13/16 (554)	32 1/2 (825)	2 1/8 (54)
9500PR4 / FR4				27 1/2 (699)	44 1/2 (1130)	

IN (MM) (1) CAN BE CUT TO SIZE - SEE PRODUCT INSTALLATION INSTRUCTIONS FOR DETAILS

PARTS & COMPONENTS

See 9500 Trims & Accessories for additional items.



9500ACPR
Main chassis cover for 9500PR.

9500ACFR
Main chassis cover for 9500FR.



9500KB357
Sex nut thru-bolt kit (6) for 1 3/4" (45.5mm) thick doors. Included with 9500FR.

9500KB363
Sex nut thru-bolt kit (6) for 2 1/4" (57mm) thick doors.



9500KG401
Glass bead shim kit for main chassis and end bracket.



9500AS200
Optional roller-type strike for 9500PR. Includes shim and mounting hardware.



9500AS239
Standard strike for 9500PR. Includes shim and mounting hardware.



9500AS245
Standard strike for 9500FR. Includes shim and mounting hardware.



9500AS251
Overlapping strike for double doors with paired panic exit devices, includes mounting hardware. Requires door coordinator (sold separately).





- Certifications**
- Certified ANSI/BHMA A156.3, Grade 1
 - cULus listed, Panic Exit
 - cULus listed, up to 3hr Fire Exit
 - Meets ADA/ANSI A117.1 for accessible operation
 - Meets California Building Code Sec. 11B-309.4
 - 10 Year limited warranty

- Rail Assembly**
- Steel rail assembly
 - Stainless steel assembly (32D finish)
 - Field sizable
 - Panic model convertible to Less Bottom Rod

- Handing**
- Handed, field reversible

- Door Size**
- 30–38x84" (762–965x2134 mm)
 - 36–48x96" (914–1219x2438 mm) – option
- See Selection Guide for details.*

- Door Thickness**
- 1 3/4" (45.5 mm)
 - 2 1/4" (57 mm) – option*
- (*) Requires #9500KB363, see Parts & Accessories*

- Stile Width**
- 4 1/2" (114 mm) minimum
- Measured from door edge*

- Projection**
- 2 1/2" (64 mm) from door surface

- Vertical Rods**
- for 84" (2134 mm) door
 - for 96" (2438 mm) door – option
 - for 126" (3200 mm) panic door – available

- Latches**
- Top: stainless steel, deadlocking
 - Bottom: stainless steel

- Strikes**
- 9500PV Top: steel, standard type #9500AS227
 - 9500PV Bottom: steel, standard type #9500AS221
 - 9500FV/FL Top: steel, standard type #9500AS245
 - 9500FV Bottom: steel, standard type #9500AS233
- Other strikes available*

- Dogging**
- For Panic Exit models only
 - Hex key dogging
 - Cylinder dogging¹ – available
- (1) See 9500 Trims & Accessories*

- Mounting Hardware**
- Machine and wood screws
 - Sex nut & thru-bolts¹ – available
 - Glass bead shim kit – available
- (1) Required for non-reinforced hollow metal doors. Included with Fire Exit models*

- Electrical Options**
- Electric latch retraction – option
 - Alarm kit – available*
 - Request to exit – available*
- (*) Sold separately, see 9500 Trims & Accessories*

- Fire Latch**
- Auxiliary Fire Latch available, #9500AVFL
 - Included with 9500FL (Less Bottom Rod)

- Trims**
- Lever, knob, pull, plate, escutcheon and handleset trims available
- Sold separately, see 9500 Trims & Accessories*

- Finish**
- 19–Matte black, painted; 28–Aluminum, painted; 32D–Satin Stainless Steel
- Other finishes available by special order*

9500PV	37	LHR	–	28
MODEL ¹	SIZE ¹	HAND ²		FINISH

(1) SEE SELECTION GUIDE (2) LHR–LEFT HAND REVERSED, RHR – RIGHT HAND REVERSED

SELECTION GUIDE

MODEL		SIZE	DOOR SIZE ¹	DOGGING	FINISH	/ CASE
9500PV	Panic Exit Hardware	37	30–38x84 (965–914x2134)	●	19, 28, 32D	4
	Surface Vertical Rod	48	36–48x96 (914–1219x2438)	●	28, 32D	4
9500FV	Fire Exit Hardware ²	37	30–38x84 (965–914x2134)	—	19, 28, 32D	4
	Surface Vertical Rod	48	36–48x96 (914–1219x2438)	—	28, 32D	4
9500FL	Fire Exit Hardware ²	37	30–38x84 (965–914x2134)	—	19, 28, 32D	4
	Less Bottom Rod	48	36–48x96 (914–1219x2438)	—	28, 32D	4

(1) RECOMMENDED DOOR SIZE, IN (MM), FOR NON-STANDARD SIZES OR INSTALLATIONS PLEASE CONTACT. (2) FIRE EXIT HARDWARE MUST BE INSTALLED ON FIRE EXIT LABELLED DOORS.

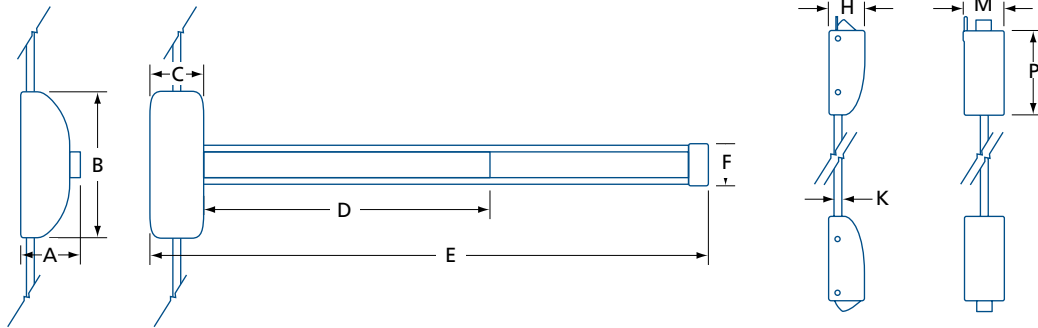

MODEL	A	B	C	D	E ²	F	H	K	M	P
9500PV 37	2 1/2	7 11/16	2 11/16	21 13/16	32 1/2	2 1/8	2	∅ 1/2	2 1/8 (54)	3 15/16
9500FV / FL ¹ 37	(64)	(196)	(68)	(554)	(825)	(54)	(51)	(12.7)	2 5/8 (67)	100
9500PV 48	2 1/2	7 11/16	2 11/16	27 1/2	44 1/2	2 1/8	2	∅ 1/2	2 1/8 (54)	3 15/16
9500FV / FL ¹ 48	(64)	(196)	(68)	(699)	(1130)	(54)	(51)	(12.7)	2 5/8 (67)	100

IN(MM) (1) 9500FL MODEL DOES NOT INCLUDE BOTTOM ROD AND BOTTOM LATCH (2) CAN BE CUT TO SIZE - SEE PRODUCT INSTALLATION INSTRUCTIONS

PARTS & COMPONENTS

See 9500 Trims & Accessories for additional items.



9500ACPV
Main chassis cover for 9500PV.



9500ACFV
Main chassis cover for 9500FV / FL.

9500AVFB
Bottom latch case for 9500FV.

9500AVFT
Top latch case for 9500FV / FL

9500AVPB
Bottom latch case for 9500PV.

9500AVPT
Top latch case for 9500PV.



9500AT96
Top rod for 84 to 96" (2134-2438mm) tall door.

9500AT126
Top rod for non-fire 96 to 126" (2438-3200mm) tall door.

9500ABR
Replacement bottom rod.

9500AG
Replacement vertical rod guide.



9500KG406
Glass bead shim kit for 9500PV exit device.

9500KG412
Glass bead shim kit for 9500FV / FL exit device.



9500AS221
Bottom strike for 9500PV exit device.



9500AS227
Top strike for 9500PV exit device.



9500AS233
Bottom strike for 9500FV. Includes mounting hardware. Included with 9500FV.



9500AS245
Top strike for 9500FV / FL. Includes shim and mounting hardware.



9500AVFL
Auxiliary fire latch. Includes mounting hardware. Included with 9500FL.



9500KB369
Sex nut thru-bolt kit (14) for 1 3/4" (45.5 mm) thick doors. Included with 9500FV / FL.

9500KB375
Sex nut thru-bolt kit (14) for 2 1/4" (57 mm) thick doors.



9500TT HANDLESET TRIM



Model	9500TT03	9500TT04	9500TT05
Function	Passage (#3)	Storeroom (#4) ↔	Entrance (#5) ↔
Finish	28, 32D	28, 32D	28, 32D
Cylinder ¹	—	Rim ²	Mortise ²
Plate (HxW)	14 1/2 x 2 5/8 (368 x 67)	14 1/2 x 2 5/8 (368 x 67)	14 1/2 x 2 5/8 (368 x 67)
Pull (B)	6 1/8 (156)	6 1/8 (156)	6 1/8 (156)
Projection (C)	2 1/8 (54)	2 1/8 (54)	2 1/8 (54)
Door Thickness	1 3/4 (44.5)*	1 3/4 (44.5)*	1 3/4 (44.5)*
Warranty	1 Year limited	1 Year limited	1 Year limited

IN (MM) (1) SOLID BRASS, 6-PIN CYLINDER, SCHLAGE "C", 2 KEYS INCLUDED – KEYING SERVICES AVAILABLE (2) SFIC KIT AVAILABLE, CORE SOLD SEPARATELY
 (*) 2 1/4IN (57MM) DOOR KIT AVAILABLE #9500KE225-TT

9500TK/TL TRIM STYLES

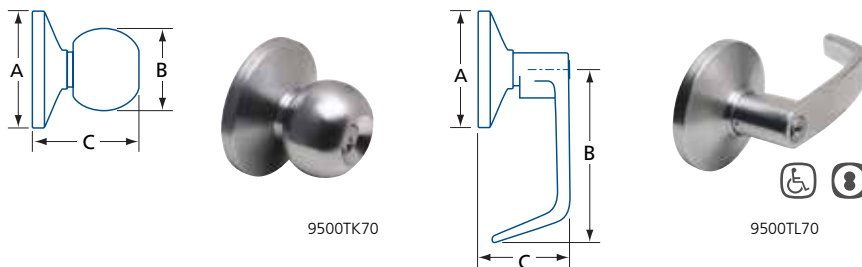

Trim	9500TK	9500TL
Available Functions ¹	10 Passage 70 Classroom ↔ 80 Storeroom ↔	10 Passage 70 Classroom ↔ ² 80 Storeroom ↔ ²
Finish	26D	26D, 19
Rose (A)	3 3/8 (86)	3 3/8 (86)
Length (B)	ø 2 1/4 (57)	4 7/16 (113)
Projection (C)	2 3/4 (70)	2 9/16 (65)
Door Thickness	1 3/4 (44.5)*	1 3/4 (44.5)*
Warranty	1 Year limited	1 Year limited

IN (MM) (1) KEYPED FUNCTIONS INCLUDE: SOLID BRASS, 6-PIN CYLINDER, SCHLAGE "C", 2 KEYS – KEYING SERVICES AVAILABLE (2) SFIC MODEL AVAILABLE, CORE SOLD SEPARATELY
 (*) 2 1/4IN (57MM) DOOR KIT AVAILABLE #9500KE225-TL

9500 SERIES

EXIT DEVICE TRIMS & ACCESSORIES



9500TE2 ESCUTCHEON TRIM

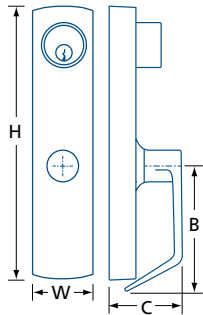

Model	9500TE210	9500TE270	9500TE280	9500TE70IC	9500TE80IC
Function	Passage	Classroom ⇄	Storeroom ⇄	Classroom ⇄	Storeroom ⇄
Finish	19, 26D, 28	19, 26D, 28	19, 26D, 28	26D	26D
Lever	Straight return	Straight return	Straight return	Straight return	Straight return
Cylinder	—	Mortise ¹	Mortise ¹	SFIC Housing ²	SFIC Housing ²
Escutcheon (HxW)	8 ⁵ / ₈ x2 ³ / ₄ (219x70)	8 ⁵ / ₈ x2 ³ / ₄ (219x70)	8 ⁵ / ₈ x2 ³ / ₄ (219x70)	8 ⁵ / ₈ x2 ³ / ₄ (219x70)	8 ⁵ / ₈ x2 ³ / ₄ (219x70)
Lever (B)	4 ⁵ / ₈ (118)	4 ⁵ / ₈ (118)	4 ⁵ / ₈ (118)	4 ⁵ / ₈ (118)	4 ⁵ / ₈ (118)
Projection (C)	2 ³ / ₈ (60)	2 ³ / ₈ (60)	2 ³ / ₈ (60)	2 ³ / ₈ (60)	2 ³ / ₈ (60)
Door Thickness	1 ³ / ₄ (44.5)*	1 ³ / ₄ (44.5)*	1 ³ / ₄ (44.5)*	1 ³ / ₄ (44.5)*	1 ³ / ₄ (44.5)*
Warranty	1 Year limited	1 Year limited	1 Year limited	1 Year limited	1 Year limited

IN (MM) (1) SOLID BRASS, 6-PIN CYLINDER, SCHLAGE "C", 2 KEYS INCLUDED – KEYING SERVICES AVAILABLE (2) SFIC CORE SOLD SEPARATELY
 (*) 2 1/4IN (57MM) DOOR KIT AVAILABLE #9500KE225-TE

9500TED ESCUTCHEON TRIM

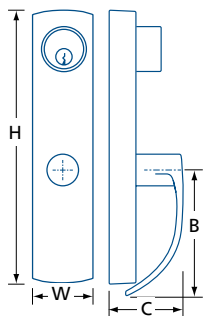

Model	9500TED10	9500TED70	9500TED80
Function	Passage	Classroom ⇄	Storeroom ⇄
Finish	26D	26D	19, 26D
Lever	Curved return	Curved return	Curved return
Cylinder	—	Mortise ¹	Mortise ¹
Escutcheon (HxW)	8 ⁷ / ₈ x2 ¹ / ₂ (225x64)	8 ⁷ / ₈ x2 ¹ / ₂ (225x64)	8 ⁷ / ₈ x2 ¹ / ₂ (225x64)
Lever (B)	4 ⁵ / ₈ (118)	4 ⁵ / ₈ (118)	4 ⁵ / ₈ (118)
Projection (C)	2 ³ / ₈ (60)	2 ³ / ₈ (60)	2 ³ / ₈ (60)
Door Thickness	1 ³ / ₄ (44.5)*	1 ³ / ₄ (44.5)*	1 ³ / ₄ (44.5)*
Warranty	1 Year limited	1 Year limited	1 Year limited

IN (MM) (1) SOLID BRASS, 6-PIN CYLINDER, SCHLAGE "C", 2 KEYS INCLUDED – KEYING SERVICES AVAILABLE (2) 2 1/4IN (57MM) DOOR KIT AVAILABLE #9500KE225-TE



9500TEH ESCUTCHEON TRIM – HEAVY DUTY



Model	9500TEH10	9500TEH70	9500TEH80
Function	Passage	Classroom ↔	Storeroom ↔
Finish	32D	32D	32D
Lever	Straight return	Straight return ²	Straight return ²
Cylinder	—	Mortise ¹	Mortise ¹
Escutcheon (H x W)	10 ½ x 2 ¾ (268 x 67)	10 ½ x 2 ¾ (268 x 67)	10 ½ x 2 ¾ (268 x 67)
Lever (B)	4 ⅝ (118)	4 ⅝ (118)	4 ⅝ (118)
Projection (C)	2 ⅜ (72)	2 ⅜ (72)	2 ⅜ (72)
Door Thickness	1 ¾ – 2 ¼ (44.5 – 57)	1 ¾ – 2 ¼ (44.5 – 57)	1 ¾ – 2 ¼ (44.5 – 57)
Warranty	5 Year limited	5 Year limited	5 Year limited

IN (MM) (1) SOLID BRASS, 6-PIN CYLINDER, SCHLAGE "C", 2 KEYS INCLUDED – KEYING SERVICES AVAILABLE (2) LEVER WITH CLUTCH

9500 SERIES

EXIT DEVICE TRIMS & ACCESSORIES



PULLS & PLATES



Trim	9500TPEP	9500TPDT	9500TPNL
Finish	28-Aluminum, painted	28-Aluminum, painted	28-Aluminum, painted
Function	Blank plate (#1)	Dummy pull (#2)	Night latch (#4)
Cylinder	—	—	Rim ¹
Projection (B)	—	1¼(32)	1¼(32)
Plate (HxW)	5½ ¹ / ₁₆ x3 (144x76)	7 ¹⁹ / ₁₆ x3 (198x76)	7 ¹⁹ / ₁₆ x3 (198x76)
Door Thickness	1¾ (44.5)	1¾ (44.5)	1¾ (44.5)

IN (MM) (1) SOLID BRASS, 6-PIN CYLINDER, SCHLAGE "C", 2 KEYS INCLUDED – KEYING SERVICES AVAILABLE; SFIC MODEL AVAILABLE, CORE SOLD SEPARATELY

OTHER ACCESSORIES



9500KA
Push pad alarm kit for 9500 exit devices.
#9500KA36 for 36" (914mm) models.
#9500KA48 for 48" (1219mm) models.



9500KD
Cylinder dogging kit for 9500 Panic Exit devices only.
#9500KD36 for size 36" (914mm) models.
#9500KD48 for size 48" (1219mm) models.

9500KE225-TE
9500TE2 Extension kit for 2¼" (57mm) door

9500KE225-TT
9500TT Extension kit for 2¼" (57mm) door



9500KSRX
Push pad request to exit switch kit.
Requires rail modification—please contact.





LHR MODEL
SHOWN

BHMA
CERTIFIED

G1

UL US
LISTED

3H

♿

10
YEAR

- Certifications**
- Certified ANSI/BHMA A156.3, Grade 1
 - cULus listed, up to 3hr Fire Exit¹
 - Meets ADA/ANSI A117.1 for accessible operation
 - Meets California Building Code Sec. 11B-309.4
 - 10 Year limited warranty

(1) Panic Hardware model available by special order

- Rail Assembly**
- Stainless steel rail assembly
 - Field sizable

- Handing**
- Handed, field reversible

- Door Width**
- 30–38" (762–965 mm)
 - 36–48" (914–1219 mm) – option

- Door Thickness**
- 1 3/4" (45 mm)

- Stile Width**
- 5 1/2" (140 mm) minimum
- Measured from door edge*

- Projection**
- 2 9/16" (65 mm) from door surface

- Lock Case**
- Fits ANSI/BHMA A115.1 door preparation
 - Adjustable faceplate for bevelled doors up to 1/8" over 2" (3 mm over 51 mm)
 - Field reversible handing
 - Steel construction

- Latchbolt**
- 2 piece, anti-friction stainless steel latchbolt with deadlatch
 - 3/4" (19 mm) throw

- Strike**
- ANSI strike
 - Stainless steel

- Dogging** —

- Hardware**
- Machine and wood screws

- Electrical**
- Electric latch retraction – option

- Options**
- Alarm kit – available*
 - Request to exit kit – available*

(* Sold separately, see 9500 Trims & Accessories

- Functions**
- 10 Passage
 - 70 Classroom
 - 80 Storeroom

Escutcheon lever trim & mortise cylinder required, not included – sold separately, see 9500TEMU

- Trims**
- Escutcheon trim (matching function) – required

Sold separately, see 9500TEMU

- Finish**
- 32D–Satin Stainless Steel

Other finishes available by special order

9500FMU	70	R3	LHR	–	32D
MODEL	FUNCTION	SIZE ¹	HAND ²		FINISH

(1) SEE SELECTION GUIDE (2) LHR–LEFT HAND REVERSED, RHR–RIGHT HAND REVERSED

SELECTION GUIDE

MODEL	FUNCTION	SIZE	DOOR WIDTH ¹	DOGGING	FINISH	/CASE	
9500FMU	Fire Exit Hardware ² Mortise Rim	10 Passage	R3	30–38 (762–965)	—	32D	4
		70 Classroom ➔ 80 Storeroom ➔	R4*	36–48 (914–1219)	—	32D	4

(1) RECOMMENDED DOOR WIDTH, IN (MM), FOR NON-STANDARD SIZES OR INSTALLATIONS PLEASE CONTACT. (2) FIRE EXIT HARDWARE MUST BE INSTALLED ON FIRE LABELLED DOORS.
(*) SPECIAL ORDER—PLEASE CONTACT.

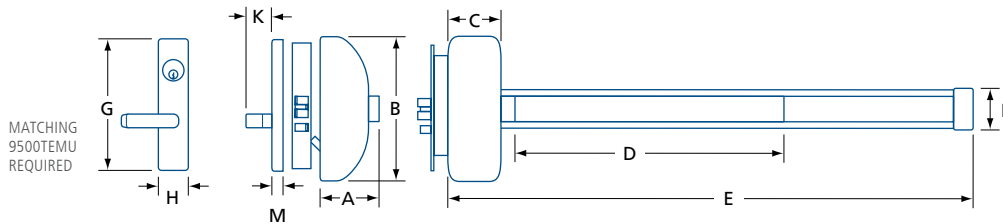

MODEL	A	B	C	D	E ¹	F	G	H	K	M
9500FMU R3	2 9/16 (65)	8 11/16 (220)	2 5/8 (67)	2 1/4 (540)	32 11/16 (830)	2 3/8 (59)	8 1/2 (216)	2 (50.8)	2 1/8 (54)	1/2 (12.7)
9500FMU R4				2 7/2 (698)	44 11/16 (1135)					

IN (MM) (1) CAN BE CUT TO SIZE - SEE PRODUCT INSTALLATION INSTRUCTIONS

9500TEMU ESCUTCHEON TRIM



Trim	9500TEMU 10	9500TEMU 70	9500TEMU 80
Exit Device	9500FMU 10	9500FMU 70	9500FMU 80
Function	Passage	Classroom ➔	Storeroom ➔
Finish	26D	26D	26D
Lever	Straight return	Straight return	Straight return
Cylinder	—	Not included ¹	Not included ¹
Escutcheon (HxW)	8 1/2 x 2 (216 x 50.8)	8 1/2 x 2 (216 x 50.8)	8 1/2 x 2 (216 x 50.8)
Lever (B)	4 9/16 (116)	4 9/16 (116)	4 9/16 (116)
Projection (C)	2 5/8 (67)	2 5/8 (67)	2 5/8 (67)
Door Thickness	1 3/4 (44.5)	1 3/4 (44.5)	1 3/4 (44.5)
Warranty	1 Year limited	1 Year limited	1 Year limited

IN (MM) (1) REQUIRES 1-3/8IN (35MM) MORTISE CYLINDER WITH FALCON-TYPE CAM, ORDER #MC138-SCKD, FOR CMK ORDER #MC138-SCKD6CMK.

PARTS & COMPONENTS

See 9500 Trims & Accessories for additional items.





- Certifications**
- Certified ANSI/BHMA A156.3, Grade 1
 - cULus listed, up to 3hr Fire Exit¹
 - Meets ADA/ANSI A117.1 for accessible operation
 - Meets California Building Code Sec. 11B-309.4
 - 10 Year limited warranty

(1) Panic Hardware model available by special order

- Rail Assembly**
- Stainless steel rail assembly
 - Field sizable

- Handing**
- Handed, field reversible

- Door Size**
- 30–38x84" (762–965x2134 mm)
 - 36–48x96" (914–1219 x2438 mm) – option

- Door Thickness**
- 1 3/4" (45 mm)

- Stile Width**
- 4 1/2" (114 mm) minimum
- Measured from door edge*

- Projection**
- 2 9/16" (65 mm) from door surface

- Vertical Rods**
- For 7' (2134 mm) tall doors

- Latchbolts**
- Top: stainless steel, hook type
 - Bottom: stainless steel, pullman type, with 1 9/32" (15 mm) throw¹

(1) Adjustable for recessed or roller strike

- Strikes**
- Top: recessed, stainless steel
 - Bottom: recessed, stainless steel
 - Optional bottom roller strike (stainless steel) included

- Dogging**
- Not available on FIRE EXIT hardware, only available on PANIC EXIT hardware

- Hardware**
- Machine and anchor bolts

- Electrical Options**
- Electric latch retraction – option
 - Alarm kit – available*
 - Request to exit kit – available*

(* Sold separately, see 9500 Trims & Accessories

- Trims**
- Escutcheon trim – available
- Sold separately, see 9500TECU*

- Finish**
- 32D–Satin Stainless Steel
 - 19–Matte Black

Other finishes available by special order

9500FCU	37	LHR	-	32D
MODEL	SIZE ¹	HAND ²		FINISH

(1) SEE SELECTION GUIDE (2) LHR–LEFT HAND REVERSED, RHR – RIGHT HAND REVERSED

SELECTION GUIDE

MODEL	SIZE	DOOR SIZE ¹	DOGGING	FINISH	/CASE
9500FCU Fire Exit Hardware ² Concealed Vertical Rod	37	30-38x84 (762-965x2134)	—	19, 32D	4
	48*	36-48x96 (914-1219x2438)	—	19, 32D	4

(1) RECOMMENDED DOOR SIZE, IN (MM), FOR NON-STANDARD SIZES OR INSTALLATIONS PLEASE CONTACT. (2) FIRE EXIT HARDWARE MUST BE INSTALLED ON FIRE EXIT LABELLED DOORS.
(*) SPECIAL ORDER—PLEASE CONTACT

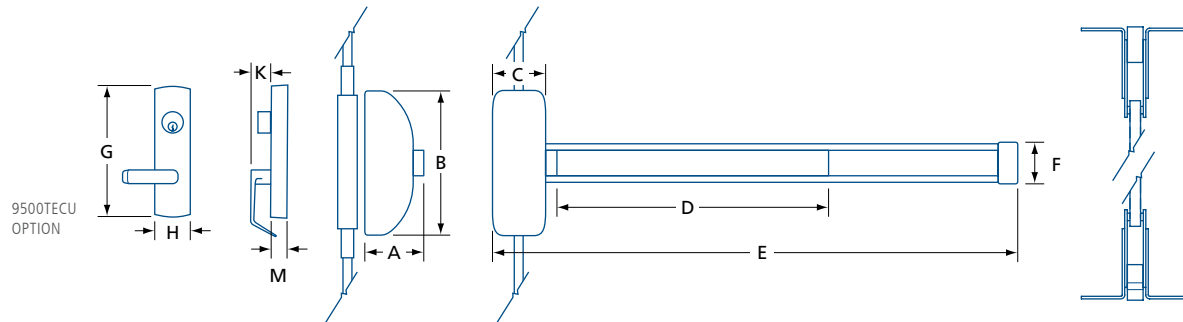

MODEL	A	B	C	D	E ¹	F	G	H	K	M
9500FCU 37	2 ⁹ / ₁₆ (65)	8 ¹¹ / ₁₆ (220)	2 ⁵ / ₈ (67)	21 ¹ / ₄ (540)	32 ¹¹ / ₁₆ (830)	2 ³ / ₈ (59)	10 ⁷ / ₁₆ (265)	2 ¹¹ / ₁₆ (68.2)	2 ³ / ₈ (60)	3 ³ / ₄ (19.5)
9500FCU 48				27 ¹ / ₂ (698)	44 ¹¹ / ₁₆ (1135)					

IN (MM) (1) CAN BE CUT TO SIZE - SEE PRODUCT INSTALLATION INSTRUCTIONS

9500TECU ESCUTCHEON TRIM



Trim	9500TECU 70	9500TECU 80
Function	Classroom ↵	Storeroom ↵
Finish	26D	19*, 26D
Lever	Standard return	Standard return
Cylinder ¹	Mortise	Mortise
Door Thickness	1 ³ / ₄ (44.5)	1 ³ / ₄ (44.5)
Warranty	1 Year limited	1 Year limited

IN (MM) (1) SOLID BRASS, 6-PIN CYLINDER, 1-1/4IN (32MM), SCHLAGE "C", 2 KEYS INCLUDED – KEYING SERVICES AVAILABLE (*) SPECIAL ORDER – PLEASE CONTACT.

PARTS & COMPONENTS

See 9500 Trims & Accessories for additional items.





Available for 9500 Rim, Mortise, Surface Vertical and Concealed Vertical Rod exit devices.

The Electronic Latch Retraction (EL) option for the 9500 series exit devices provides the ability to remotely retract the latchbolt. Designed for entrance or exit doors (panic or fire-exit hardware) where remote unlocking, dogging or access control is required.

9500EL uses a retraction motor rather than a solenoid for quiet operation, ideal for locations in theatres, conference rooms or any noise-sensitive applications.

The 9500EL can be paired with card readers, toggle or key switches, buttons, sensors, door operators and/or fire alarms.

FEATURES

- cULus Listed, Panic Exit or Fire Exit Hardware
- 1 Year limited warranty (exit device electronics and motor)
- 10 Year limited warranty (as per exit device)
- Available for all 9500 Exit Device models (Fire Exit or Panic Hardware) - including 9500MU and 9500CU
- For doors 36 - 38" (914 - 965mm) order 3ft. (R3 or 37) device
- For doors 42 - 48" (1067 - 1219mm) order 4ft. (R4 or 48) device
- Motor driven push-pad retraction for smooth and quiet operation
- On-board diagnostics with audible feedback
- Easy post-installation adjustment
- Electric dogging rated for continuous duty with auto re-engagement if push-pad is pulled from dogged position
- Low Current Draw device (900mA / 215mA); field adjustable to high torque (2A / 250mA) if required for tough applications
- Power input required: 24VDC ±10%
- Power supply, power transfers, request-to-exit and access control readers, switches, buttons, sensors, etc. – all sold separately

9500	EL	M	70	R3	LHR	-	32D
SERIES	MODEL ¹	FUNCTION ¹	SIZE ¹	HAND ¹	FINISH ¹		

(1) SEE SELECTION GUIDE OF REQUIRED DEVICE FOR DETAILS AND AVAILABILITY

ACCESSORIES



PS204B

Class 2, 110-120VAC, 60Hz, input power supply that delivers 2 Amp @ 24VDC $\pm 10\%$ to 4 PTC fused outputs. Includes 4 solid-state input triggers and fire alarm link. For use with electric locks, motor driven exit devices, electric strikes, and mag locks. Back-up batteries (2x 12VDC 7AH) and cam lock not included.
WxHxD: 13 x 15.5 x 5" (330 x 394 x 127 mm)



ABH-PT200

Wired power transfer with (2) 18 AWG wires (MAX. 24VDC, 5A); 180° door opening; rated for use on fire doors.
See page 04.610 for more details.



ABH-PT180 / ABH-PT105

Non-wired power transfer (pass-through); supports 180° or 105° door openings. Square or round corners. Not rated for use on fire doors.
See page 04.610 for more details.



JC-603QC-BB1079-ETW04/08

Wired power transfer hinge with (4) or (8) 28 AWG wires (MAX. 24V, 4A) with molex connector. Must be installed with ball bearing hinges of the same size (4½ x 4). Not rated for use on fire doors.
See page 04.620 for more details.



SDL-20AL

Non-wired surface mounted door loop with flexible armoured conduit. Not rated for use on fire doors.
See page 04.611 for more details.



CDL-AL

Non-wired concealed door loop. Armoured conduit slides into the door and/or door frame. Supports 180° door openings. Easy to install, not rated for use on fire doors.
See page 04.611 for more details.

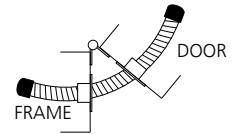
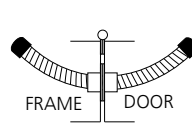



Pushbutton trims are only available bundled with DOREX 9500PR or 9500FR exit devices.



TB20BR-26D



TB50XS-26D

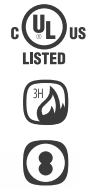

DOREX 9500 Pushbutton Trim Kits provide exterior access by combination while allowing free egress with the bundled DOREX 9500 Exit Device.

Available in both mechanical and electronic models, these trims eliminate problems and costs associated with issuing, controlling, and collecting physical keys or cards.

The mechanical bundle eliminates the need for troublesome wiring or battery replacement. Its single code can be programmed directly from the keypad without removing the trim from the door.

The electronic bundle can handle up to 100 access codes, all programmed via the keyboard without a computer or web connection. Its low power consumption allows batteries to last for many months before replacement.

These pushbutton trims are available only when bundled with DOREX 9500PR or 9500FR exit devices, not available individually.

FEATURES

- cULus Listed, Panic Exit or Fire Exit Hardware (3HR)
- Bundled only with 9500 Rim Exit Device models

Mechanical Pushbutton Trim

- Mechanical pushbutton access control (1 code)
 - » TB10: Combination only
 - » TB20: Combination with key override (SFIC/LFIC)
- 3 Year limited warranty

- For doors 1¾–2¼" (44.5–57 mm) thick
- Factory handed; not field reversible
- Requires 5" (127 mm) door stile
- Vandal resistant, solid metal push buttons
- Weather resistant

Electronic Pushbutton Trim

- Electronic pushbutton access control (100 codes)
 - » TB50: Combination with key override (SFIC/LFIC)
- Certified ANSI/BHMA A156.3 / A156.25 Grade 1
- 5 Year limited warranty
- For doors 1¾–2¼" (44.5–57 mm) thick
- Non handed; field reversible
- Powered by 4xAA batteries (not included)
- Requires 5" (127 mm) door stile
- Weather resistant

MECHANICAL PUSHBUTTON TRIM KIT

TB10, TB20

- Mechanical pushbutton access control
- cULus Listed; 3 hour fire rating
- 3 Year limited warranty (Refer to 02.020 for exit device)

Programming

- Single access code – one easy-to-manage code for all users

Operating Modes

- Pushbutton Access – TB10
 - » Combination entry only
 - » Exit Device may be "dogged" without affecting trim
- Pushbutton Access with Key Override – TB20
 - » Combination entry or
 - » Key-in-Lever cylinder manually retracts latch
 - » Keyed override uses small (B) or large (S) format interchangeable cores (SFIC or LFIC) – cores not included
 - » CX5 high security SFIC cores available

Installation

- Heavy-duty cast front housing with heavy-duty mounting plate
- Bundled with 9500PR or 9500FR rim exit devices only
- For doors 1¾–2¼" (44.5–57 mm) thick
- 5" (127 mm) tail-piece for freezer doors (sold separately)
- Factory handed; not field reversible
- Requires 5" (127 mm) door stile
- Vandal resistant, solid metal push buttons
- Weather resistant

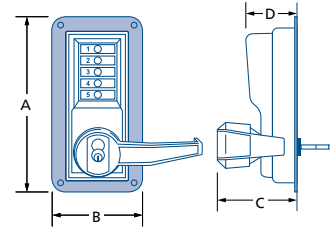

A	B	C	D
8¾	4¾	3½	2¾
(222)	(111)	(100)	(60)

IN (MM)

9500	PR	3	-	28	-	TB20	B	L	-	26D
EXIT DEVICE ¹		TRIM MODE		CYLINDER ²		HAND ³		FINISH ⁴		

(1) 9500PR/FR ONLY, SEE 02.020 (2) LEAVE BLANK FOR TBM10, B: SFIC (DEFAULT), S: LFIC
 (3) L: FOR LH OR LHR DEVICE, R: FOR RH OR RHR DEVICE (4) SATIN CHROME ONLY
 PLEASE CONTACT YOUR LOCAL SALES REPRESENTATIVE FOR HELP ORDERING.

ELECTRONIC PUSHBUTTON TRIM KIT

TB50

- Certified ANSI/BHMA A156.3 Grade 1
- Certified ANSI/BHMA A156.25 Grade 1 (electronics)
- cULus Listed; 3 hour fire rating
- 3 Year limited warranty (Refer to 02.020 for exit device)

Programming

- Via keypad – up to 100 access codes
- Passage Mode – can be toggled on/off via keypad or key override

Operating Mode

- Pushbutton Access with Key Override – TB50
 - » Combination entry
 - » Key-in-Lever cylinder manually unlocks lever

Key Override

- 6-pin cylinder (Schlage "C") with 2 keys included (XS - Default)
- Models using small (B) or large (S) format interchangeable cores (SFIC or LFIC) available – cores not included
- CX5 high security cores available

Installation

- Extra heavy duty, cast trim and lever for intensive indoor and exterior applications
- For doors 1¾–2¼" (44.5–57 mm) thick
- Bundled with 9500PR or 9500FR rim exit devices only
- Fits ASA 161 door preparation
- No wires through door
- Powered by 4xAA alkaline batteries (not included)
- Non-handed
- Requires 5" (127 mm) door stile
- Weather resistant:
 - » Exterior trim: -35 to 66 °C (-31 to 151 °F)
 - » Interior trim: -35 to 55 °C (-31 to 130 °F)

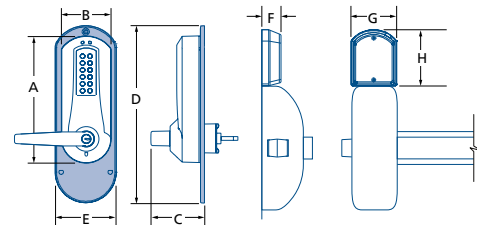

A	B	C	D	E	F	G	H
8¾	3½	4½	12½	4¼	1¾	3¾	¾
(225)	(84.7)	(109)	(313)	(108)	(35)	(81)	(98)

IN (MM)

9500	PR	3	-	28	-	TB50	XS	-	26D
EXIT DEVICE ¹		TRIM MODE		CYLINDER ²		FINISH ³			

(1) 9500PR/FR ONLY, SEE 02.020 (2) XS: KIL (DEFAULT), B: SFIC, S: LFIC (3) SATIN CHROME ONLY
 PLEASE CONTACT YOUR LOCAL SALES REPRESENTATIVE FOR HELP ORDERING.





- Certifications**
- Conforms to ANSI/BHMA A156.3, Grade 2
 - cULus listed, Panic Exit
 - cULus listed, up to 90 min. Fire Exit
 - 1 Year limited warranty

- Rail Assembly**
- Steel rail assembly
 - Stainless steel assembly (C32D finish)
 - Field sizable

- Handing**
- Non-handed

- Door Width**
- 30–38" (762–965 mm)
 - 36–48" (914–1219 mm) – option
- See Selection Guide for details*

- Door Height**
- up to 96" (2438 mm)
 - 8500F maximum: 84" (2134 mm)
- See Selection Guide for details*

- Door Thickness**
- 1 3/4" (45.5 mm)

- Stile Width**
- 4" (106.1 mm) minimum
- Measured from door edge*

- Projection**
- 2 9/16" (65 mm) from door surface

- Latchbolt**
- Stainless steel, 3/4" (19 mm) throw
 - Deadlatch

- Strike**
- Cast iron, standard type #8000S
- Other strikes available*

- Dogging**
- For Panic Exit models only
 - Hex key dogging

- Hardware**
- Machine and wood screws
 - Sex nuts & thru-bolts¹ – available
- (1) Required for non-reinforced hollow metal doors, included with Fire Exit models*

Electrical Options

- Trims**
- Lever, knob, pull, and handleset trims available
- Sold separately, see 8500 Trims & Accessories*

- Finish**
- C19–Matte black; C28–Aluminum, painted; C3–Polished brass; C32D–Satin stainless steel
- Other finishes available by special order*

8500	C32D	–	48
MODEL ¹	FINISH		OPTION ²

(1) SEE SELECTION GUIDE (2) 48: FOR NON-FIRE DOORS 36-48 IN (914-1219MM) WIDE

SELECTION GUIDE

MODEL		DOOR WIDTH	DOOR HEIGHT	DOGGING	FINISH	/CASE
8500	Panic Exit Hardware, Rim device	30–38 ¹ (762–965)	96 ¹ (2438)	•	C19, C28, C3, C32D	4
8500 -48		36–48 ¹ (914–1219)	96 ¹ (2438)	•	C19, C28, C32D	4
8500F	Fire Exit Hardware ² Rim device	30–36 ^{MAX} (762–914)	84 ^{MAX} (2134)	—	C19, C28, C3, C32D	4

IN (MM) (1) RECOMMENDED DOOR SIZE FOR PANIC INSTALLATIONS, UP TO 8FT (244 CM) TALL.
(2) FIRE EXIT HARDWARE MUST BE INSTALLED ON FIRE EXIT LABELLED DOORS NO MORE THAN 7FT (213CM) TALL AND 36IN (914MM) WIDE.

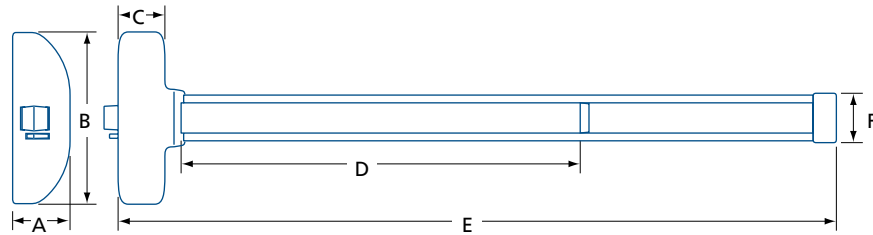

MODEL	A	B	C	D	E ¹	F
8500 / 8500F	2 ⁹ / ₁₆ (65)	7 ¹¹ / ₁₆ (195)	2 (50.8)	20 ¹ / ₄ (514)	33 ¹ / ₄ (845)	1 ¹⁵ / ₁₆ (50)
8500 -48				30 (762)	45 ⁵ / ₁₆ (1150)	

IN (MM) (1) CAN BE CUT TO SIZE - SEE PRODUCT INSTALLATION INSTRUCTIONS

PARTS & COMPONENTS

See 8500 Trims & Accessories for additional items.



8000S
Regular ¹²/₃₂" (16.5 mm) cast iron strike for panic and fire rim device.

8000S-L
Low-profile ¹⁵/₃₂" (12 mm) cast iron strike for panic rim device. Includes ⁵/₆₄" (2 mm) shims.



8000DDS
Overlapping cast iron strike for double doors and paired panic exit devices only.





- Certifications**
- Conforms to ANSI/BHMA A156.3, Grade 2
 - cULus listed, Panic Exit
 - cULus listed, up to 90 min. Fire Exit
 - 1 Year limited warranty

- Rail Assembly**
- Steel rail assembly
 - Stainless steel assembly (C32D finish)
 - Field sizable

- Handing**
- Non-handed

- Door Width**
- 30–38" (762–965)
 - 36–48" (914–1219) – option
- See Selection Guide for details*

- Door Height**
- Up to 96" (2438 mm) – with extension
 - 8500VF maximum: 84" (2134 mm)
- See Selection Guide for details*

- Door Thickness**
- 1 3/4" (45.5 mm)

- Stile Width**
- 4" (106.1 mm) minimum
- Measured from door edge*

- Projection**
- 2 9/16" (65 mm) from door surface

- Vertical Rods**
- For 7' (2134 mm) doors
 - For 8' (2438 mm) door – available¹
- (1) Panic Exit model only, with #8500EXT96 extension rod, sold separately*

- Latchbolts**
- Top: stainless steel, deadlatch
 - Bottom: stainless steel

- Strikes**
- Top: steel, standard type
 - Bottom: steel, standard type

- Dogging**
- For Panic Exit models only
 - Hex key dogging

- Hardware**
- Machine and wood screws
 - Sex nut & thru-bolts¹ – available
- (1) Required for non-reinforced hollow metal doors, included with Fire Exit models*

Electrical Options

- Trims**
- Lever, knob, pull, and handleset trims available
- Sold separately, see 8500 Trims & Accessories*

- Finish**
- C28–Aluminum; C3–Polished brass; C32D–Satin stainless steel
- Other finishes available by special order*

8500V	C32D	–	48
MODEL ¹	FINISH		OPTION ²

(1) SEE SELECTION GUIDE (2) 48: FOR NON-FIRE DOORS 36-48 IN (914-1219MM) WIDE UP TO 96 IN (2438 MM)

SELECTION GUIDE

MODEL		DOOR WIDTH	DOOR HEIGHT	DOGGING	FINISH	/CASE
8500V	Panic Exit Hardware, surface vertical rod	30–38 ¹ (762–965)	84 ¹ (2134)	●	C28, C32D	4
8500V -48		36–48 ¹ (914–1219)	84 ¹ (2134)	●	C28, C32D	4
8500VF	Fire Exit Hardware ² , surface vertical rod	30–36 MAX (762–914)	84 MAX (2134)	—	C28, C3, C32D	4

IN (MM) (1) RECOMMENDED DOOR SIZE FOR PANIC INSTALLATIONS; EXTENSION KIT AVAILABLE FOR DOORS UP TO 8FT (244CM) TALL.
(2) FIRE EXIT HARDWARE MUST BE INSTALLED ON FIRE EXIT LABELLED DOORS NO MORE THAN 7FT (213CM) TALL AND 36IN (914MM) WIDE.

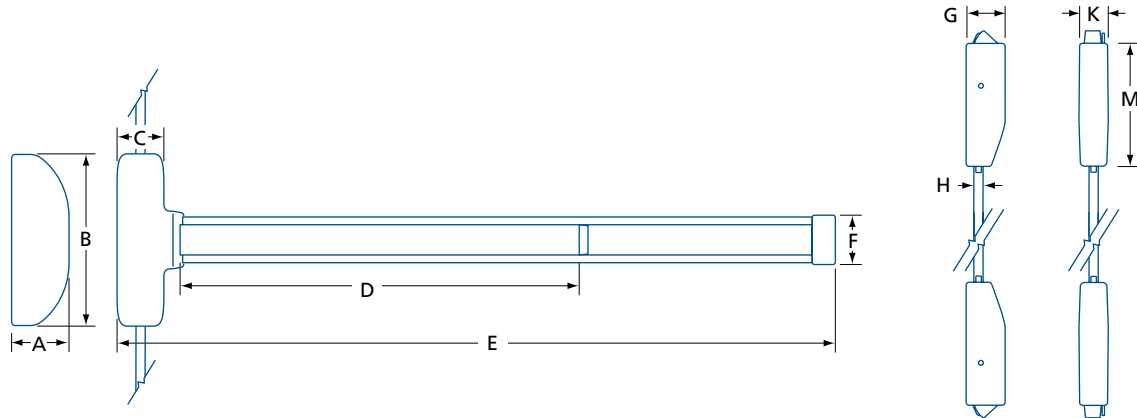

MODEL	A	B	C	D	E ¹	F	G	H	K	M
8500V / 8500VF	2 ⁹ / ₁₆ (65)	7 ¹¹ / ₁₆ (195)	2 (50.8)	20 ¹ / ₄ (514)	33 ¹ / ₄ (845)	1 ¹⁵ / ₁₆ (50)	2 (50.8)	∅ ³ / ₈ (10)	1 ³ / ₈ (35)	5 ⁷ / ₈ (149)
8500V -48				30 (762)	45 ⁵ / ₁₆ (1150)					

IN (MM) (1) CAN BE CUT TO SIZE - SEE PRODUCT INSTALLATION INSTRUCTIONS

PARTS & COMPONENTS

See 8500 Trims & Accessories for additional items.



8500EXT96
12" (304.8mm) extension rod for door
84–96" (2134–2438 mm) tall. For use with
#8500V Panic Exit model only.



8500TT HANDLESET TRIMS

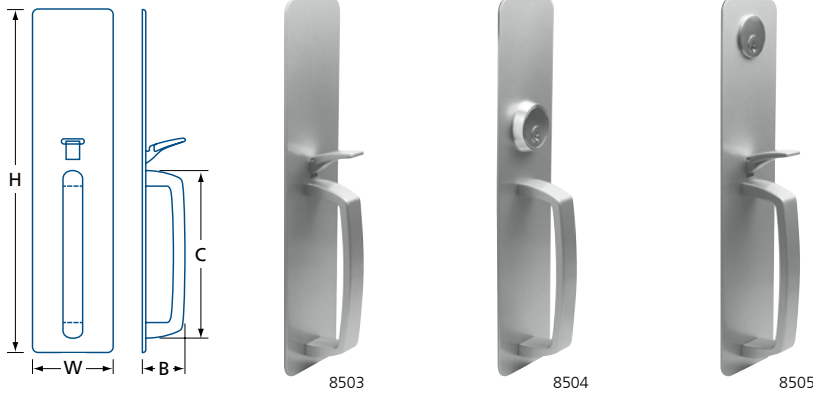

MODEL	8503	8504	8505
Finish	C19–Matte Black, C15–Satin nickel, C28–Aluminum, C3–Polished brass	C19–Matte Black, C15–Satin nickel, C28–Aluminum, C3–Polished brass	C19–Matte Black, C15–Satin nickel, C28–Aluminum, C3–Polished brass
Function	Passage (#3)	Storeroom (#4) ⇄	Entrance (#5) ⇄
Cylinder ¹	—	Threaded rim (Schlage C) ²	Mortise (Schlage C) ³
Projection (B)	1 13/16 (46)	1 13/16 (46)	1 13/16 (46)
Plate (HxW)	12 1/4 x 3 (311 x 76)	12 1/4 x 3 (311 x 76)	12 1/4 x 3 (311 x 76)
Pull (C)	5 5/16 (151)	5 5/16 (151)	5 5/16 (151)
Door Thickness	1 3/4 (44.5)	1 3/4 (44.5)	1 3/4 (44.5)
Warranty	1 Year limited	1 Year limited	1 Year limited

IN (MM) (1) SOLIDBRASS, 6-PIN CYLINDER, 2 KEYS INCLUDED—KEYING SERVICES AVAILABLE (2) WEISER CONVERSION REQUIRES MR118WR CYLINDER, SOLD SEPARATELY (3) WEISER CONVERSION REQUIRES CBM118B-WRKD CYLINDER, SOLD SEPARATELY

8500 LEVER TRIMS

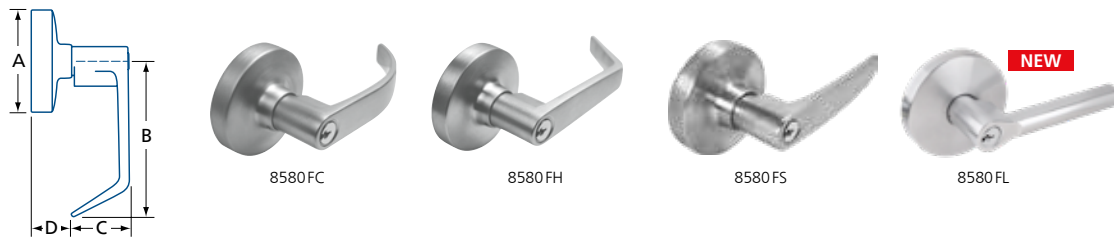

MODEL	8500FC	8500FH	8500FS	8500FL
Available Functions ¹	10 Passage 70 Classroom ⇄ 80 Storeroom ⇄	10 Passage 70 Classroom ⇄ 80 Storeroom ⇄	10 Passage 70 Classroom ⇄ 80 Storeroom ⇄	10 Passage 70 Classroom ⇄ 80 Storeroom ⇄
ALLKEYED LEVERS HAVE CLUTCH RELEASE.				
Finish	C26D–Satin Chrome, C3–Polished brass	C19–Matte Black, C26D–Satin Chrome	C26D–Satin Chrome	C19–Matte Black, C26D–Satin Chrome
A	ø 3 1/16 (78)	ø 3 1/16 (78)	ø 3 1/16 (78)	ø 3 1/16 (78)
B	4 5/8 (117)	4 5/8 (117)	4 5/8 (117)	4 5/8 (117)
C	2 (50.8)	2 (50.8)	3/8 (16)	3/4 (19)
D	1 1/16 (17)	1 1/16 (17)	2 1/8 (54)	2 (50.8)
Door Thickness	1 3/4 (44.5)	1 3/4 (44.5)	1 3/4 (44.5)	1 3/4 (44.5)
Warranty	1 Year limited	1 Year limited	1 Year limited	1 Year limited

IN (MM) (1) KEYED FUNCTIONS INCLUDESOLIDBRASS, 6-PIN CYLINDER, SCHLAGE C CYLINDER, 2 KEYS—KEYING SERVICES AVAILABLE.

8500 SERIES

EXIT DEVICE TRIMS & ACCESSORIES

DOREX®

8500 KNOB TRIM

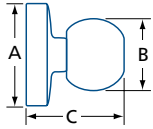

8510B

MODEL	8500B
Available Functions¹	10 Passage 70 Classroom ← 80 Storeroom ←
Finish	C32D-Satin stainless steel
A	ø3 1/16 (78)
B	ø2 3/16 (55)
C	2 1/16 (75)
Door Thickness	1 3/4 (44.5)
Warranty	1 Year limited

IN (MM) (1) KEYED FUNCTIONS INCLUDE SOLID BRASS, 6-PIN CYLINDER, SCHLAGE C CYLINDER, 2 KEYS-KEYING SERVICES AVAILABLE.

PULLS & PLATES

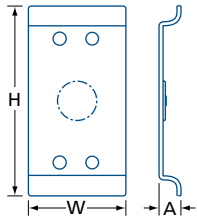

MODEL	8000NLS	8000DT	8000NL
Finish	Stainless Steel	Aluminum, painted	Aluminum, painted
Function	Night latch (#4)	Dummy pull (#2)	Night latch (#4)
Cylinder¹	—	—	—
Projection (A)	1 3/16 (21)	1 3/16 (30)	1 3/16 (30)
Plate (H x W)	3 x 1 3/4 (36 x 44.5)	6 3/8 x 3 1/2 (162 x 89)	6 3/8 x 3 1/2 (162 x 89)

IN (MM) (1) RIM CYLINDER NOT INCLUDED, SOLD SEPARATELY

OTHER ACCESSORIES



8000ASAB

ASA strike filler plate.

8000BS

ASA strike and latch faceplate filler plates.



8000EOP

Cross bore cover plate, painted steel



9500KTRC

Rim cylinder mounting kit.





- Certifications**
 - Conforms to ANSI/BHMA A156.3, Grade 2
 - cULus listed, Panic Exit
 - cULus listed, up to 90min. Fire Exit
 - 1 Year limited warranty
- Rail Assembly**
 - Steel
 - Field sizable
- Handing**
 - Non-handed
- Door Width**
 - 28–38" (711–965 mm)
- Door Thickness**
 - 1 ¾" (45.5 mm)
- Stile Width**
 - 4 ½" (114 mm) minimum
 - Measured from door edge*
- Projection**
 - 2 ½" (64 mm) from door surface
- Latchbolt**
 - Stainless steel
 - Deadlatch

- Strike**
 - Cast iron, standard type #8000S
 - Other strikes available*
- Dogging**
 - For Panic Exit Hardware only
 - Hex key dogging
- Hardware**
 - Machine and wood screws
 - Sex nuts & tru-bolts¹ – available
 - (1) Required for non-reinforced hollow metal doors, included with Fire Exit models*
- Electrical Options**
 -
- Trims**
 - Fully compatible with DOREX 8500 lever, knob, pull and handleset trims
 - Sold separately, see 8500 Trims & Accessories*
- Finish**
 - AL—Aluminum
 - Other finishes available by special order*

8000	AL
MODEL ¹	FINISH

(1) SEE SELECTION GUIDE

SELECTION GUIDE

MODEL		DOOR WIDTH ¹	DOGGING	FINISH	/ CASE
8000	Panic Exit Hardware Rim Device	28–38 (711–965)	•	AL	6
8000F	Fire Exit Hardware ² Rim Device	28–38 (711–965)	—	AL	6

(1) RECOMMENDED DOOR WIDTH, IN (MM), FOR NON-STANDARD SIZES OR INSTALLATIONS PLEASE CONTACT. (2) FIRE EXIT HARDWARE MUST BE INSTALLED ON FIRE EXIT LABELLED DOORS.



MODEL	A	B	C	D	E ¹	F
8000 / 8000F	2½ (64)	47/16 (113)	2 (51)	29½ (749)	327/8 (835)	1 15/16 (49)

IN (MM) (1) CAN BE CUT TO SIZE - SEE PRODUCT INSTALLATION INSTRUCTIONS

PARTS & COMPONENTS

Fully compatible with DOREX 8500 Trims & Accessories



8000S
Regular 1½/32" (16.5 mm) cast iron strike for panic rim device. Included with 8000.

8000S-L
Low-profile 15/32" (12 mm) cast iron strike for panic rim device. Includes 5/64" (2 mm) shims.



8000DDS
Overlapping cast iron strike for double doors and paired panic exit devices only.



DOREX[®]



DX2

**GRADE 1 EXIT DEVICES
NARROW STILE**

DX2

The DX2 Series Narrow Head Exit Devices are designed and manufactured for simplicity, strength, durability, aesthetics and installer-friendly innovations.

- Devices and trims are designed for new or retrofit installation into other manufacturers' exit devices and trims.
- Made to comply with the highest safety and security standards in the industry.
- cULus listed for Panic Exit Hardware or 3-hour Fire Rated Exit Hardware.
- Certified ANSI/BHMA A156.3-2014 Grade 1.

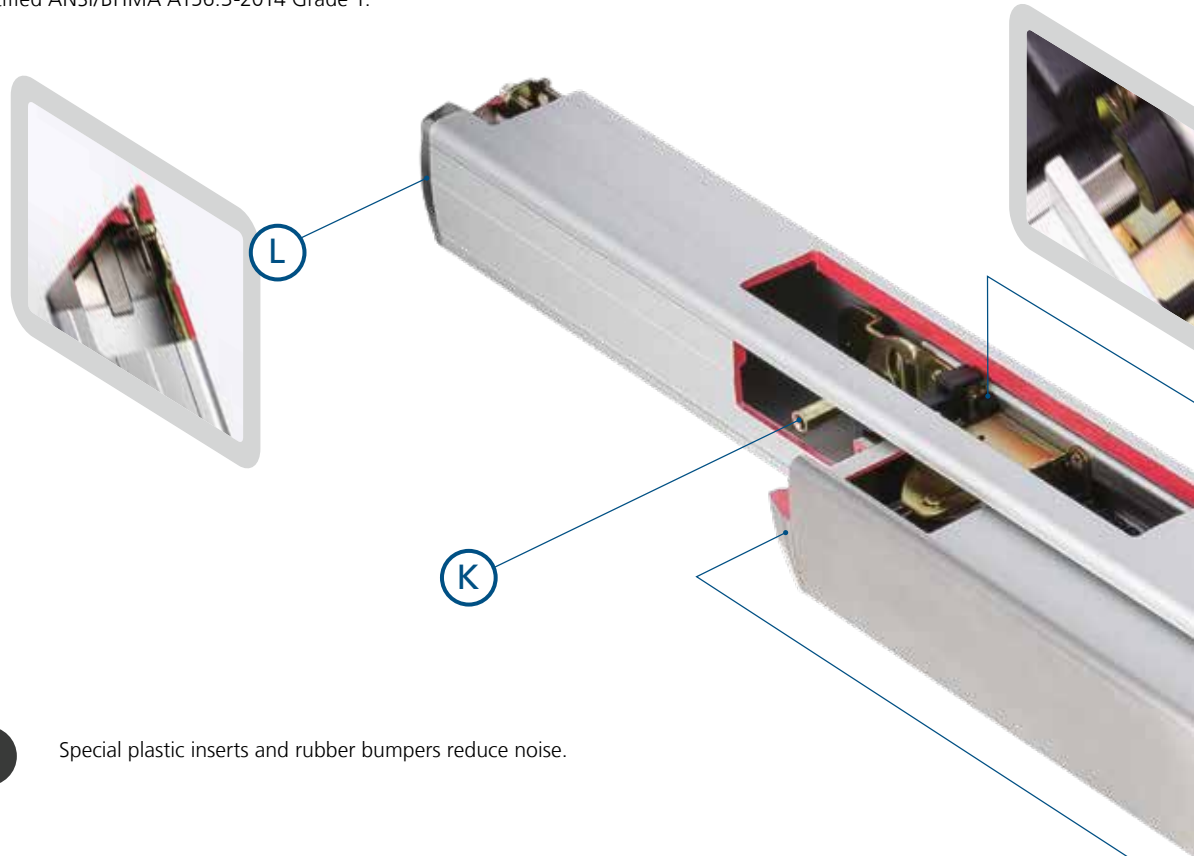

- A** Special plastic inserts and rubber bumpers reduce noise.
- B** Detachable center case allows switching between mechanical and electrical options which replaces the need of buying two complete sets.
- C** Center case with maximum versatility, surface and concealed vertical rods can be adjusted inside the center case with an ingenious rod holder design.
- D** Cross spindle offers additional strength.
- E** Replaceable cam breaks at a predetermined load to prevent further damage of the trim mechanism. Handing change is simple and easy.
- F** Center Case mounting plate made of heavy gauge steel adding extra strength.
- G** Stainless steel latch and security deadlatch.

J



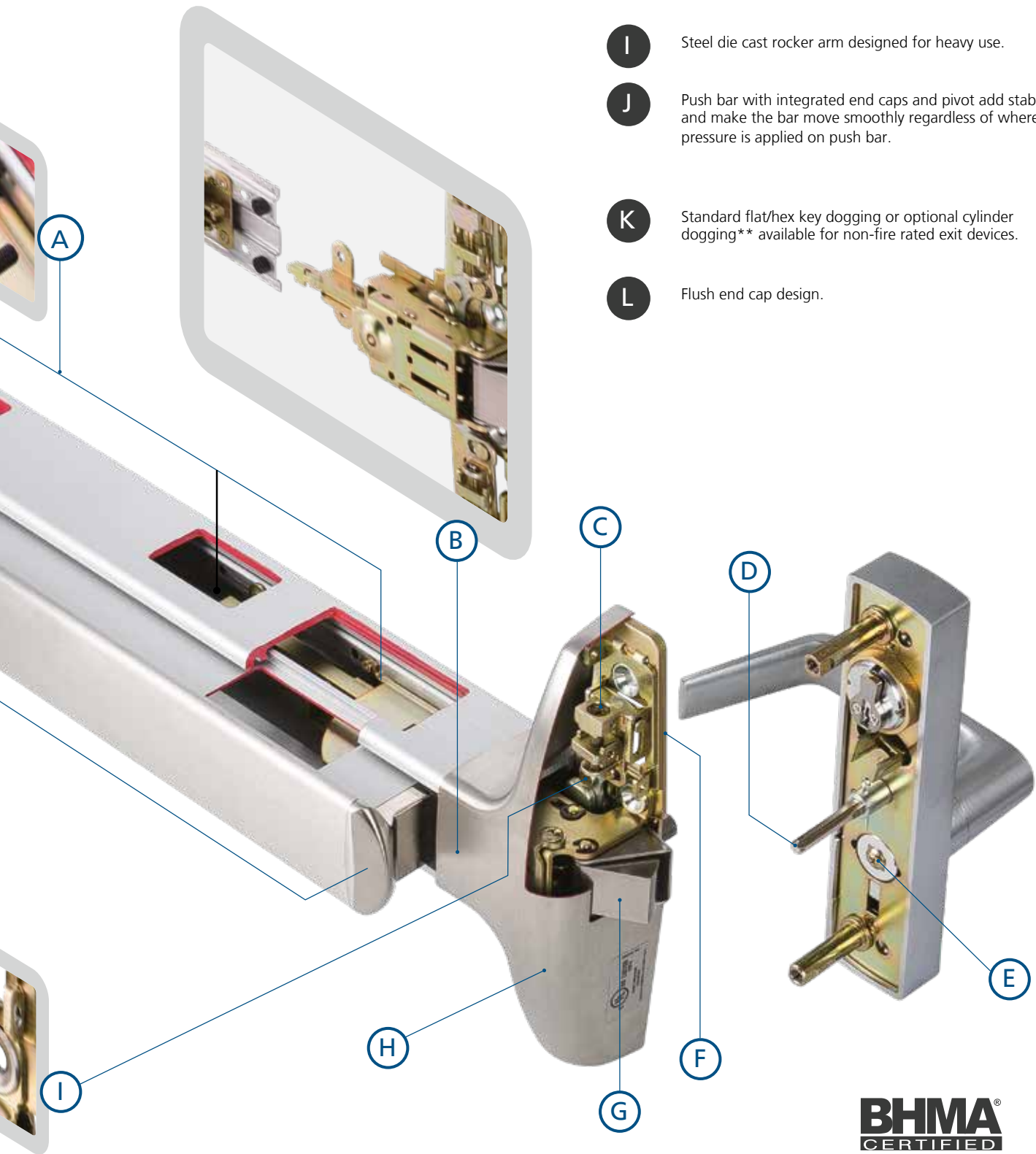

H

Center Case fits minimum 2" stile.

I

Steel die cast rocker arm designed for heavy use.

J

Push bar with integrated end caps and pivot add stability and make the bar move smoothly regardless of where the pressure is applied on push bar.

K

Standard flat/hex key dogging or optional cylinder dogging** available for non-fire rated exit devices.

L

Flush end cap design.

BHMA[®]
CERTIFIED

UL[®] US
LISTED

* SPECIAL ORDER – WILL REQUIRE ADDITIONAL LEAD TIME AND MINIMUM ORDER QUANTITIES.

** CYLINDERS SOLD SEPARATELY

General Overview

Device Material

DX2 Series ext devices are furnished standard with a smooth case. Models with a grooved case are available. The two styles are mechanically and dimensionally identical and come with a wide selection of finishes.



Finishes

Color	ANSI/BHMA	US	Part Material & Finish:		
			B / E / G	A / D	C / F / H
Satin Stainless Steel	630	32D	Stainless Steel, Satin	Plated	Anodized ¹
Satin Chrome*	626	26D	Brass, Satin & Plated	Plated	Anodized ¹
Polished Chrome*	625	26	Brass, Polished & Plated	Plated	Buffed Anodized ¹
Oil Rubbed Bronze*	613	10B	Bronze, Satin; Dark Oxidized	Plated	Anodized ¹
Satin Bronze*	612	10	Bronze, Satin	Plated	Anodized ¹
Polished Bronze*	611	9	Bronze, Polished	Plated	Buffed Anodized ¹
Satin Brass*	606	4	Brass, Satin	Plated	Anodized ¹
Polished Brass*	605	3	Brass, Polished	Plated	Buffed Anodized ¹

(*) Special order finish, will require additional lead time and minimum order quantities. (1) Aluminum material

NOTE: Non-listed finishes are available—please contact your sales representative.

(B) Push Bar Options[†]:

- Embossed "PUSH"
- Braille, embossed "CAUTION STAIRWELL"
- Red silk screen lettered "EMERGENCY EXIT ONLY - PUSH TO OPEN & SOUND ALARM"

(†) Please contact sales representative prior to ordering.



Functions

ANSI/BHMA Number	Operation	Trim Option	
		<i>DX2TP Series Pull Trim</i>	<i>DX2TE Series Escutcheons</i>
01	Exit only, blank escutcheon or plate.	<i>DX2TPR01*</i>	N
02	Entrance by trim when bar is locked down/dogged.	<i>DX2TPR02*</i>	<i>DX2TER02*</i>
03	Entrance by trim. Key retracts latch. Key removable only when locked. (Night Latch)	<i>DX2TPR03*</i>	<i>DX2TER03*</i>
08	Entrance by knob/lever. Key locks or unlocks knob/lever.	N	<i>DX2TER08</i>
09	Entrance by knob/lever only when released by key. Key removable only when locked. (Night Latch)	N	<i>DX2TER09</i>
11	Entrance by thumb turn. Key locks or unlocks thumb turn.	N	<i>DX2TER11*</i>
12	Entrance by thumb turn only when released by key. Key removable only when locked. (Night Latch)	N	<i>DX2TER12*</i>
14	Entrance by trim when latch is released by knob/lever.	N	<i>DX2TER14*</i>
16	Entrance by trim when latch is released by thumb turn.	N	<i>DX2TER16*</i>

See pages 13–17 for more details.

Dimensions

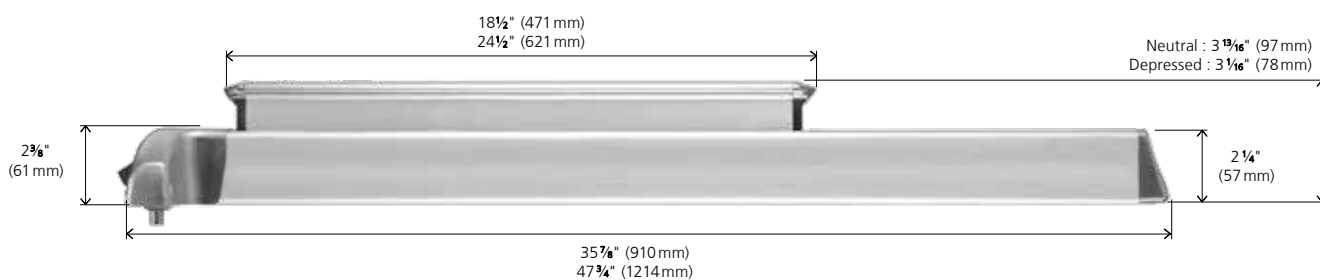

Pull Trim

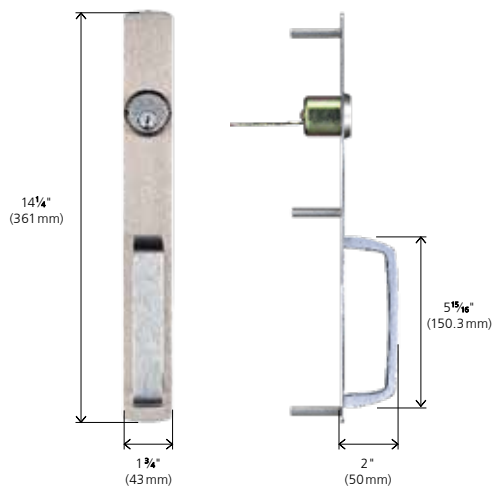

Escutcheon

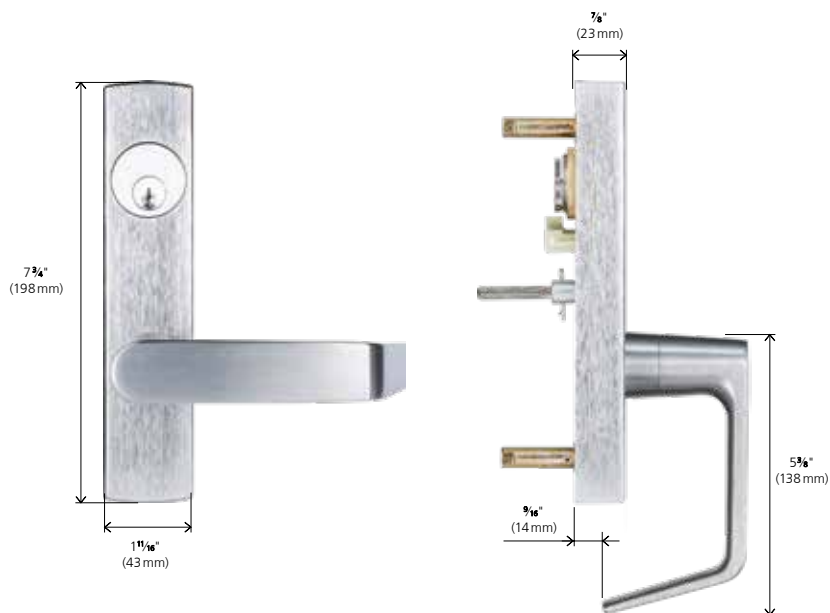



- Certifications**
- Certified ANSI/BHMA A156.3-2014, Grade 1
 - cULus listed for Panic Hardware
 - cULus listed for 3hr Fire Exit Hardware
 - Complies with NFPA 80 Fire doors

- Center Case & Rail Assembly**
- Heavy wrought steel center case
 - Adjustments accessible through center case after installation
 - Aluminum rail assembly, field sizeable

- Handing**
- Non-handed

- Door Width**
- 30–38" (762–965 mm)
 - 36–48" (914–1219 mm) – option*

- Door Height**
- 7–8 ft (2134–2438 mm) – standard

- Door Thickness**
- 1 3/4–2 1/4" (45–57 mm) – standard

- Center Latch**
- Stainless steel, 3/4" (19 mm) throw
 - Deadlocking

- Strike**
- PANIC: Steel, roller type #DXAS103 –standard
 - FIRE: Steel, roller type #DXAS108 –standard

See DX2 Accessories, p. 19–22.

- Dogging**
- NOT available on FIRE EXIT hardware
 - Flat key dogging – standard
 - Cylinder dogging – option*

- Cylinder**
- NOT included, sold separately

See DX2 Cylinders, p. 23.

- Mounting Hardware**
- Machine and wood screws – standard
 - Sex nut & thru-bolts – standard¹
 - Shims – standard

(1) With fire model. Required for fire-rated wood or composite doors and non-reinforced hollow metal doors

See DX2 Accessories, p. 19–22.

- Electrical Options***
- Alarm kit
 - Delayed egress
 - Electronic latch retraction
 - Latchbolt monitoring
 - Request to exit
 - Signal switch

(*) Special order. See DX2 Electrical, p. 25–29.

- Trims**
- Compatible trims sold separately, easy to mix and match

See DX2 Trims, p. 13–17.

- Finish**
- 630–Satin Stainless Steel

Other finishes available by special order, see p. 4.



BHMA
CERTIFIED

G1

UL
LISTED

3H

- Certifications**
- Certified ANSI/BHMA A156.3-2014, Grade 1
 - cULus listed for Panic Hardware
 - cULus listed for 3hr Fire Exit Hardware
 - Complies with NFPA 80 Fire doors

- Center Case & Rail Assembly**
- Heavy wrought steel center case with top and bottom rod adjusters.
 - Adjustments accessible through center case after installation
 - Aluminum rail assembly, field sizeable

- Handing**
- Non-handed

- Door Width**
- 30–38" (762–965 mm)
 - 36–48" (914–1219 mm) – option*

- Door Height**
- 7 ft (2134 mm) – standard
 - 8 ft (2468 mm) – option*
 - 10 ft (3048 mm) – option*

See DX2 Accessories, p. 19–22.

- Door Thickness**
- 1 3/4–2 1/4" (45–57 mm) – standard

- Top Latch**
- Stainless steel, Pullman type, 5/8" (16 mm) throw
 - Deadlocking
 - Case : 4 1/2 x 2 1/8 x 1 1/2" (114 x 54 x 38 mm)

- Bottom Latch**
- Stainless steel, Pullman type, 5/8" (16 mm) throw
 - Deadlocking
 - Round slide bolt – available^{1*}
 - Case : 4 1/2 x 2 1/8 x 1 1/2" (114 x 54 x 38 mm)

(1) Panic only, not UL listed. Certified Grade 2.

- Fire Latch**
- Available for door openings 8 ft (2438 mm) wide x 8 ft (2438 mm) high
 - Included with Less Bottom Rod (L) option

See DX2 Accessories, p. 21.

- Strikes**
- PANIC
 - » Top: Steel, roller type #DXAS203 –standard
 - » Bottom: Steel, #DXAS227 –standard
 - FIRE
 - » Top: Steel, roller type #DXAS108 –standard
 - » Bottom: Steel, #DXAS227F –standard

See DX2 Accessories, p. 19–22.

- Dogging**
- NOT available on FIRE EXIT hardware
 - Flat key dogging – standard
 - Cylinder dogging – option*

- Cylinder**
- NOT included, sold separately

See DX2 Cylinders, p. 23.

- Mounting Hardware**
- Machine and wood screws – standard
 - Sex nut & thru-bolts – standard¹
 - Shims – standard

(1) With fire model. Required for fire-rated wood or composite doors and non-reinforced hollow metal doors.

See DX2 Accessories, p. 19–22.

- Electrical Options***
- Alarm kit
 - Delayed egress
 - Electronic latch retraction
 - Latchbolt monitoring
 - Request to exit
 - Signal switch

(*) Special order. See DX2 Electrical, p. 25–29.

- Trims**
- Compatible trims sold separately, easy to mix and match - See DX2 Trims, p. 13–17.

- Finish**
- 630–Satin Stainless Steel

Other finishes available by special order, see p. 4.



- Certifications**
- Certified ANSI/BHMA A156.3-2014, Grade 1
 - cULus listed for Panic Hardware
 - cULus listed for 3hr Fire Exit Hardware
 - Complies with NFPA 80 Fire doors

- Center Case & Rail Assembly**
- Heavy wrought steel center case with top and bottom rod adjusters.
 - Adjustments accessible through center case after installation
 - Aluminum rail assembly, field sizeable

- Handing**
- Non-handed

- Door Width**
- 30–38" (762–965 mm)
 - 36–48" (914–1219 mm) – option*

- Door Height**
- 7 ft (2134 mm) – standard
 - 8 ft (2468 mm) – option*
 - 10 ft (3048 mm) – option*

See DX2 Accessories, p. 19–22.

- Door Thickness**
- 1 3/4–2 1/4" (45–57 mm) – standard

- Top Latch**
- Stainless steel, Pullman type, 5/8" (16 mm) throw
 - Deadlocking
 - Case : 4 1/2 x 2 1/8 x 1 1/2" (114 x 54 x 38 mm)

- Bottom Latch**
- Stainless steel, Pullman type, 5/8" (16 mm) throw
 - Deadlocking
 - Round slide bolt – available¹*
 - Case : 4 1/2 x 2 1/8 x 1 1/2" (114 x 54 x 38 mm)

(1) Panic only, not UL listed. Certified Grade 2.

- Fire Latch**
- Available for door openings 8 ft (2438 mm) wide x 8 ft (2438 mm) high
 - Included with Less Bottom Rod (L) option

See DX2 Accessories, p. 21.

- Strikes**
- PANIC
 - » Top: Steel, #DXAS216 –standard
 - » Bottom: Steel, #DXAS227 –standard
 - FIRE
 - » Top: Steel, #DXAS216 –standard
 - » Bottom: Steel, #DXAS227F –standard
- See DX2 Accessories, p. 19–22.

- Dogging**
- NOT available on FIRE EXIT hardware
 - Flat key dogging – standard
 - Cylinder dogging – option*

- Cylinder**
- NOT included, sold separately
- See DX2 Cylinders, p. 23.

- Mounting Hardware**
- Machine and wood screws – standard
 - Sex nut & thru-bolts – standard¹
 - Shims – standard

(1) With fire model. Required for fire-rated wood or composite doors and non-reinforced hollow metal doors

See DX2 Accessories, p. 22.

- Electrical Options***
- Alarm kit
 - Delayed egress
 - Electronic latch retraction
 - Latchbolt monitoring
 - Request to exit
 - Signal switch

(*) Special order. See DX2 Electrical, p. 25–29.

- Trims**
- Compatible trims sold separately, easy to mix and match - See DX2 Trims, p. 13–17.

- Finish** 630–Satin Stainless Steel
- Other finishes available by special order, see p. 4.



- Certifications**
- Certified ANSI/BHMA A156.3-2014, Grade 1
 - cULus listed for Panic Hardware
 - cULus listed for 3hr Fire Exit Hardware
 - Complies with NFPA 80 Fire doors

- Center Case & Rail Assembly**
- Heavy wrought steel center case with top and bottom rod adjusters.
 - Adjustments accessible through center case after installation
 - Aluminum rail assembly, field sizeable

- Handing**
- Non-handed

- Door Width**
- 30–38" (762–965 mm)
 - 36–48" (914–1219 mm) – option*

- Door Height**
- 7 ft (2134 mm) – standard
 - 8 ft (2468 mm) – option*
 - 10 ft (3048 mm) – option*

See DX2 Accessories, p. 19–22.

- Door Thickness**
- 1 3/4– 2 1/4" (45–57 mm) – standard

- Center Latch**
- Stainless steel, deadlocking, 3/4" (19 mm) throw

- Top Latch**
- Stainless steel, Pullman type, 5/8" (16 mm) throw
 - Deadlocking
 - Case : 4 1/2 x 2 1/8 x 1 1/2" (114 x 54 x 38 mm)

- Bottom Latch**
- Stainless steel, Pullman type, 5/8" (16 mm) throw
 - Deadlocking
 - Round slide bolt – available^{1*}
 - Case : 4 1/2 x 2 1/8 x 1 1/2" (114 x 54 x 38 mm)

(1) Panic only, not UL listed. Certified Grade 2.

- Fire Latch**
- Available for door openings 8 ft (2438 mm) wide x 8 ft (2438 mm) high
 - Included with Less Bottom Rod (L) option

See DX2 Accessories, p. 21.

- Strikes**
- PANIC
 - » Top: Steel, roller type #DXAS203 –standard
 - » Middle: Steel, roller type #DXAS103 –standard
 - » Bottom: Steel, #DXAS227 –standard
 - FIRE
 - » Top/Middle: Steel, roller type #DXAS108 –standard
 - » Bottom: Steel, #DXAS227F –standard

See DX2 Accessories, p. 19–22.

- Dogging**
- NOT available on FIRE EXIT hardware
 - Flat key dogging – standard
 - Cylinder dogging – option*

- Cylinder**
- NOT included, sold separately
- See DX2 Cylinders, p. 23.

- Mounting Hardware**
- Machine and wood screws – standard
 - Sex nut & thru-bolts – standard¹
 - Shims – standard

(1) With fire model. Required for fire-rated wood or composite doors and non-reinforced hollow metal door
See DX2 Accessories, p. 19–22.

- Electrical Options***
- Alarm kit
 - Delayed egress
 - Electronic latch retraction
 - Latchbolt monitoring
 - Request to exit
 - Signal switch

(*) Special order. See DX2 Electrical, p. 25–29.

- Trims**
- Compatible trims sold separately, easy to mix and match - See DX2 Trims, p. 13–17.

- Finish**
- 630–Satin Stainless Steel

Other finishes available by special order, see p. 4.

Fire Door

Maximum Door Opening Applications and Listings

Exit Device	Door Material	Single Door	Double Door		
			With mullion	2x Vertical Rod Same Direction	2x Vertical Rod Double Egress
DX2 FR RIM	Metal	3 Hours 4' x 8'	3 Hours 8' x 8'		
DX2 FV SVR	Metal	3 Hours 4' x 8'		3 Hours 8' x 8'	3 Hours 8' x 8'
DX2 FVL LBR	Metal	3 Hours 4' x 8'		3 Hours 8' x 8'	3 Hours 8' x 8'
DX2 FC CVR	Metal	3 Hours 4' x 8'		3 Hours 8' x 8'	3 Hours 8' x 8'
DX2 FCL LBR	Metal	3 Hours 4' x 8'		3 Hours 8' x 8'	3 Hours 8' x 8'
DX2 FW 3PT	Metal	3 Hours 4' x 8'	3 Hours 8' x 8'		

Metric conversion: 4' (1219mm), 8' (2438mm), 10' (3048mm)

Notes:

1. Fire exit device conforms to UL10C and UBC7-2.
2. Fire exit device is applicable for wood door with 1½-hour or 20-min fire rating.
3. Consult with door manufacturer for specific limitations on fire door assemblies.

Strike Application / Minimum Stile Width

Exit Device	Single door*		Double door*	
	Strike	Minimum stile width	Strike with mullion**	Minimum stile width
DX2 PR RIM	DXAS103	2 1/8" (54mm)	DXAS103 with mullion	3 3/4" (95.3mm)
	DXAS106†	2 3/4" (70mm)	DXAS106 with mullion	3 3/4" (95.3mm)
DX2 PV SVR	DXAS203 (Top) DXAS227 (Bottom)	2 1/2" (63mm)	DXAS203 (Top) DXAS227 (Bottom)	2 7/8" (73mm)
	DXAS106† (Top) DXAS227 (Bottom)	2 3/4" (70mm)	DXAS106† (Top) DXAS227 (Bottom)	3 1/8" (79mm)
DX2 PC CVR	DXAS216 (Top) DXAS227 (Bottom)	2 1/8" (54mm)	DXAS216 (Top) DXAS227 (Bottom)	2 7/8" (60.3mm)
	DX2 PW 3PT	DXAS103 (Middle) DXAS203 (Top) DXAS227 (Bottom)	2 1/8" (54mm)	DXAS103 with mullion DXAS203 (Top) DXAS227 (Bottom)
DXAS106† (Middle) DXAS203 (Top) DXAS227 (Bottom)		3 1/2" (88.9mm)	DXAS106† with mullion DXAS203 (Top) DXAS227 (Bottom)	3 3/4" (95.3mm)
DX2 FR RIM	DXAS108	3 1/2" (88.9mm)	DXAS108 with mullion	4" (101.4mm)
DX2 FV SVR	DXAS108 (Top) DXAS227F (Bottom)	2 1/2" (63.5mm)	DXAS108 (Top) DXAS227F (Bottom)	2 7/8" (73mm)
	DX2 FC CVR	DXAS216 (Top) DXAS227F (Bottom)	4 3/4" (120.7mm)	DXAS216 (Top) DXAS227F (Bottom)
DX2 FW 3PT	DXAS108 (Middle) DXAS108 (Top) DXAS227F (Bottom)	3 1/2" (88.9mm)	DXAS108 with mullion DXAS108 (Top) DXAS227F (Bottom)	4" (101.4mm)

†Alternative option. *For reference only, stile width may vary due to strikes used, door frame type, and required backsets. Please contact your local representative for additional information and/or details.

**Please contact representative for mullion details and options.

Dogging

What is dogging?

Dogging is a feature used in exit devices to hold the push pad or crossbar in a retracted position (holding the latch retracted), thus allowing a door to operate in push/pull mode without latching.

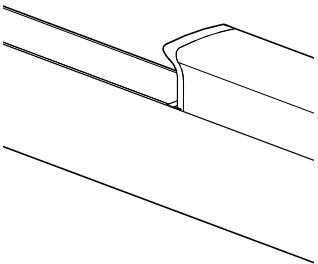
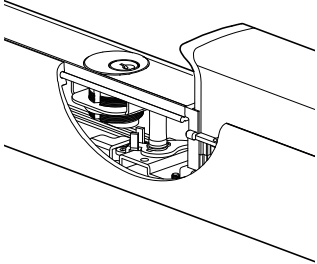
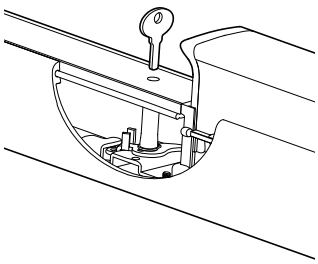
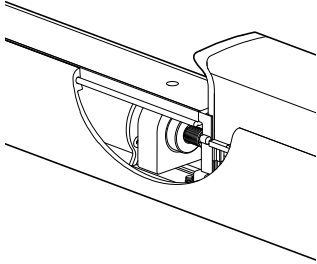
None	Cylinder	Key	Electrical
			
<p>Less or No Dogging</p> <p>Less Dogging is available for all DX2 exit devices.</p>	<p>Cylinder Dogging</p> <p>Available for all models except for Fire Exit Hardware. Cylinder Dogging provides the ability to lock down the push bar with a key cylinder.</p> <p>Requires the use of a 1 1/4" mortise cylinder that is not included and is sold separately.</p> <p>DX2 Cylinder Dogging Kit (#DX2AKD3LC - for 3ft devices). (#DX2AKD4LC - for 4ft devices).</p>	<p>Key Dogging</p> <p>Available for all models except for Fire Exit Hardware. Key dogging provides the ability to lock down the push bar with an included flat key or appropriately sized flat-headed screw driver.</p> <p>A replacement key (#DXADK) is also available.</p>	<p>Electrical Dogging</p> <p>Also known as Electrical Latch Retraction.</p> <p>For details, see page 25.</p>

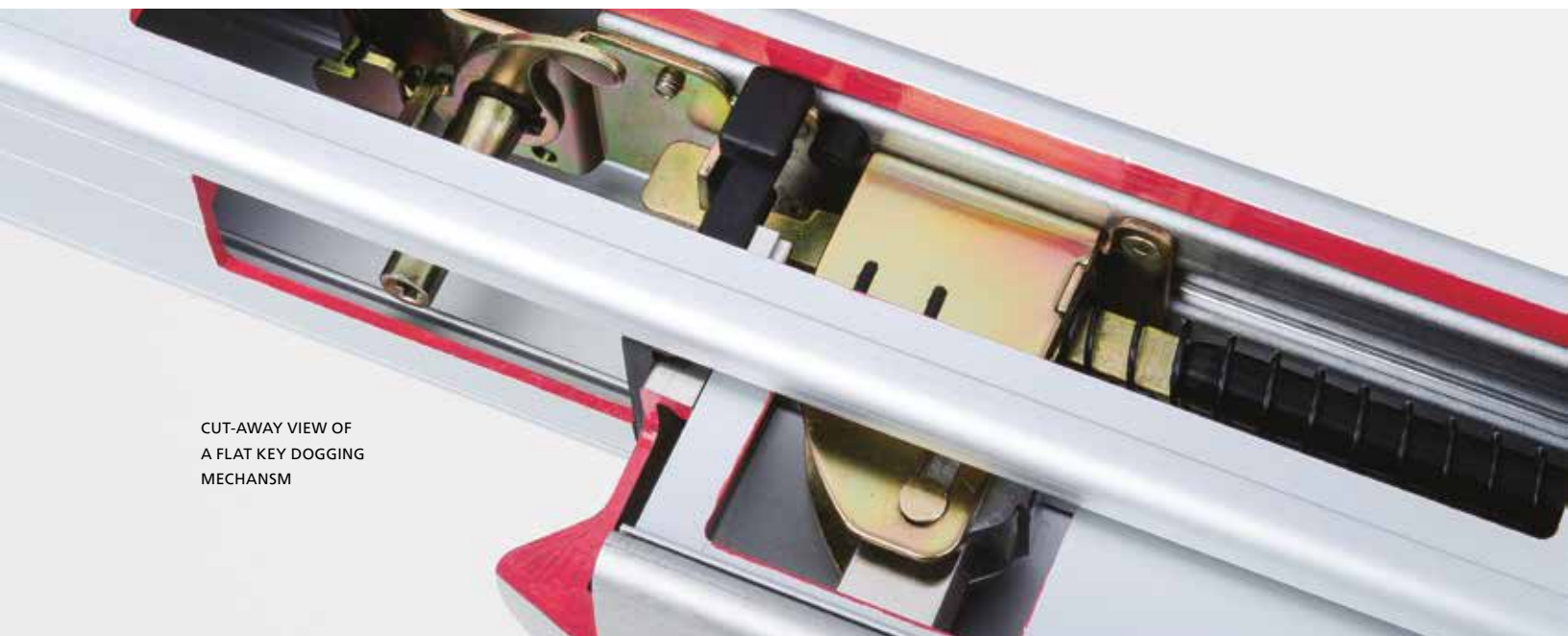

CUT-AWAY VIEW OF A FLAT KEY DOGGING MECHANISM

DX2

Trim Options

DX2TP Series Pull Trims



Plate



Pull Only



With Cylinder

DX2TE Series Escutcheon Trims



Lever



Thumb Turn



With Cylinder

DX2TP Series Pull Trims



Features

- Trims are furnished with wrought plate and extruded or with cast solid grips.
- Trims are designed to retrofit into other manufacturers' devices.
- Trims are UL/cUL certified for ANSI/BHMA A156.3-2014 Grade 1 and 3-Hour Fire Exit Hardware.
- Trims meet ADA requirements.
- Trims are through bolted.
- Satin stainless steel (630) finish – other finishes available.
- Specify handing when ordering
- Cylinder not included, see page 22.
- For Trim dimensions, see page 6.
- To order, see page 30.

Grip Options

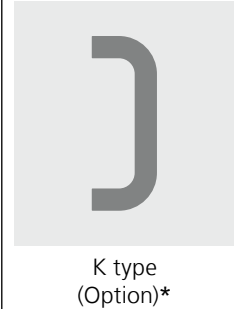
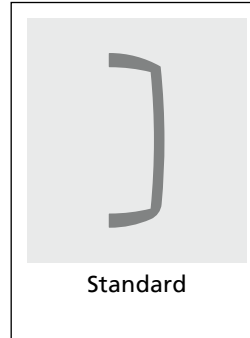

ANSI/BHMA	01	02	03
Operation	Exit only, blank escutcheon	Entrance by trim when actuating bar is locked down/dogged. (Dummy)	Entrance by trim when latch is released by key. Key removable only when locked. (Night Latch) *Cylinder collar required (not included)
Trim No.	<i>DX2TPR 01*</i>	<i>DX2TPR 02*</i>	<i>DX2TPR 03*</i>
Cylinder Type			RIM
Device No.	DX2 PR/FR DX2 PV/FV DX2 PC/FC DX2 PW/FW	DX2 PR/FR DX2 PV/FV DX2 PC/FC DX2 PW/FW	DX2 PR/FR DX2 PV/FV DX2 PC/FC DX2 PW/FW
Specify Handing**	YES	YES	YES

(**) SPECIFY LHR/RHR WHEN ORDERING – SEE PAGE 30.

DX2TE Series Escutcheon Trims



Features

- Escutcheon and lever with sleek and seamless design produced by casting or forging.
- Trims are designed to retrofit into other manufacturers' devices.
- Handing field reversible.
- Trims are UL/cUL certified for ANSI/BHMA A156.3-2014 Grade 1 and 3-Hour Fire Exit Hardware.
- Trims meet ADA requirements.
- Cylinder not included, see page 22.
- Satin chrome (626) finish – other finishes available.
- For Trim dimensions, see page 6.
- To order, see page 30.



ANSI/BHMA	11	12	16
			
Operation	Entrance by thumb-turn. Key locks or unlocks thumb turn. (Storeroom)	Entrance by thumb-turn only when released by key. Key removable only when locked. (Night Latch)	Entrance by trim when latch is released by thumb-turn. (Passage)
Trim No.	<i>DX2TER 11*</i>	<i>DX2TER 12*</i>	<i>DX2TER 16*</i>
Cylinder Type	Mortise	Rim	
Device No.	DX2 PR/FR DX2 PV/FV DX2 PC/FC DX2 PW/FW	DX2 PR/FR DX2 PV/FV DX2 PC/FC DX2 PW/FW	DX2 PR/FR DX2 PV/FV DX2 PC/FC DX2 PW/FW
Specify Handing	NO	NO	NO

DX2TE Series Escutcheon Trims



Features

- Escutcheon and lever with sleek and seamless design produced by casting or forging.
- Trims are designed to retrofit into other manufacturers' devices.
- Handing field reversible.
- Trims are UL/cUL certified for ANSI/BHMA A156.3-2014 1 and 3-Hour Fire Exit Hardware.
- Trims meet ADA requirements.
- Cylinder not included, see page 22.
- Satin chrome (626) finish – other finishes available.
- Other lever styles available.
- For Trim dimensions see page 6.
- To order, see page 30.

ANSI/BHMA	02	03	08
			
Operation	Entrance by trim when actuating bar is locked down / dogged. (Dummy)	Entrance by trim when latch is released by key. Key removable only when locked. (Night Latch)	Entrance by lever. Key locks or unlocks lever. (Classroom)
Trim No.	<i>DX2TER02*</i>	<i>DX2TER03*</i>	DX2TER08
Cylinder Type		Rim	Mortise
Device No.	DX2 PR/FR DX2 PV/FV DX2 PC/FC DX2 PW/FW	DX2 PR/FR DX2 PV/FV DX2 PC/FC DX2 PW/FW	DX2 PR/FR DX2 PV/FV DX2 PC/FC DX2 PW/FW
Specify Handing	NO	NO	NO

Lever Options

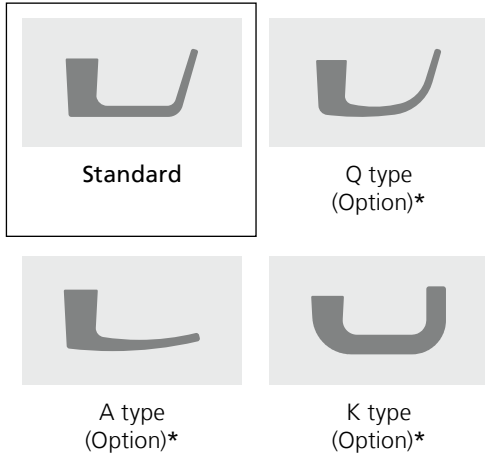

Breakable Cam



The DX2TEM (functions 08,11 only) trim includes an internal breakable cam which breaks when a predetermined load is applied to the outside thumb-turn or lever handle when locked without damaging the trim or compromising security. The cam can easily be replaced - #DXACED05.

09	14
	
Entrance by lever only when latch is released by key. Key removable only when locked. (Night Latch)	Entrance by trim when latch is released by lever. Always active, no cylinder. (Passage)
DX2TER09	DX2TER 14*
Rim	
DX2 PR/FR	DX2 PR/FR
DX2 PV/FV	DX2 PV/FV
DX2 PC/FC	DX2 PC/FC
DX2 PW/FW	DX2 PW/FW
NO	NO

Accessories

Rim Device -Strikes

P Panic Application
🔥 Fire Application



P/N. DXAS106
 Rim Strike
 Optional middle strike for DX2PR, DX2PW.
 Optional top stike for DX2PV, DX2PW.
P

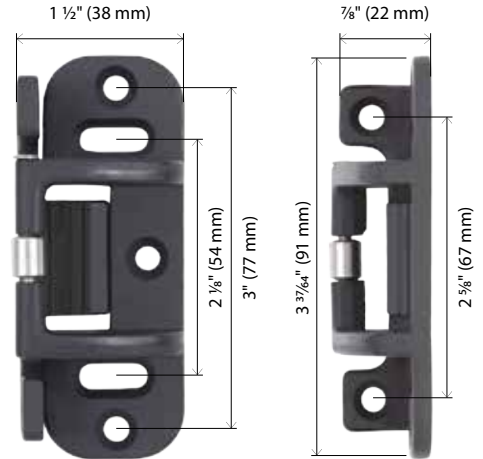

P/N. DXAS108F
 Rim Strike with Strike Hook
 Middle strike for DX2FR and DX2FW.
 Top Strike for DX2FV, DX2FW. For
 double door DX2FR/PR or DX2FW/PW
 with mullion.
P **🔥**



P/N. DXAS103
 Rim Strike
 Standard strike for DX2PR, DX2PW.
 For double door DX2PR, DX2PW with mullion.
P

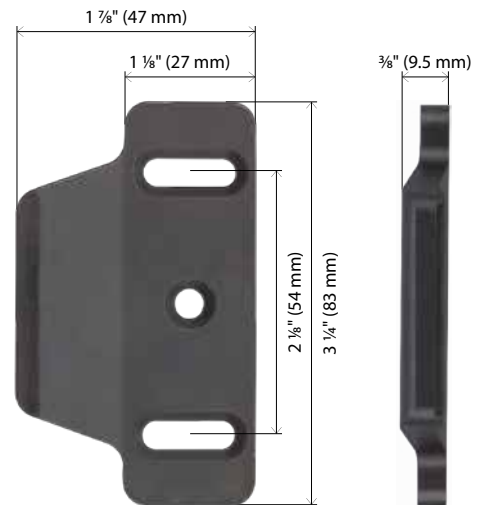

P/N. DXAS136*
 Overlapping Rim Strike
 For DX2PR or DX2PW paired with DX2PV or
 DX2PC in double door applications
 with door coordinator and no mullion.
P

Accessories

Vertical Rod (VR) Device - Strikes

P Panic Application
🔥 Fire Application

Top Strike

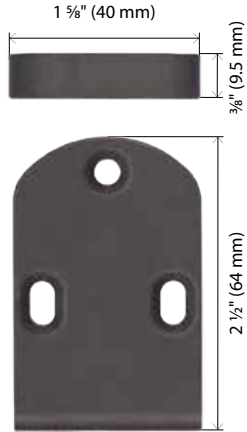

P/N. DXAS215*
 Top Strike
 For flush transom
 DX2PV/FV, DX2PW/FW.
P **🔥**

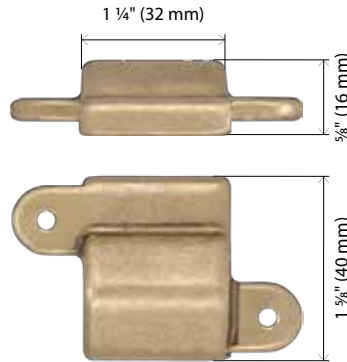

P/N. DXAS216
 Top Strike
 Standard for DX2PC/FC.
P **🔥**

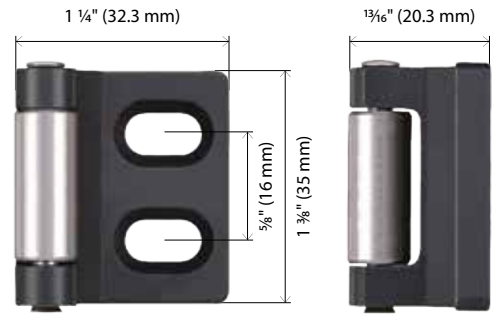

P/N. DXAS203
 Top Strike
 For DX2PV, DX2PW.
P

Vertical Rod (VR) Device - Bottom Strikes

Round

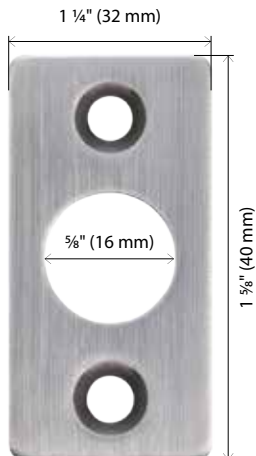

P/N. DXAS225*
 Bottom Strike
 For DX2PV, DX2PC, DX2PW
 with round slide bolt.
 (Grade 2)
P



P/N. DXAS226*
 Bottom Strike
 Optional for DX2PV/FV,
 DX2PC/FC, DX2PW/FW
 round slide bolt.
 (Grade 2)
P

Pullman

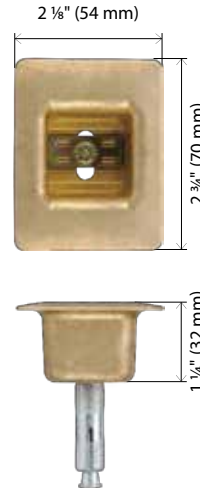

P/N. DXAS227/227F
 Bottom Strike
 Standard for DX2PV/FV,
 DX2PC/FC, DX2PW/FW.
P **🔥**

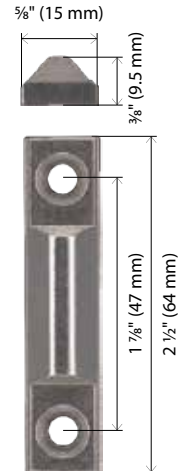

P/N. DXAS224*
 Bottom Strike
 Optional for DX2PV and
 DX2PW.
 (Grade 2)
P

Accessories

P Panic Application
F Fire Application

Shims



*P/N. DXKG6010**
 For DXAS106 Rim Strike
 Two (2) pieces furnished
 standard



*P/N. DXKG6030**
 For DXAS108 Rim Strike
 Two (2) pieces furnished
 standard



*P/N. DXKG6050**
 For DX2PC/FC top & bottom latches
 Sixteen (16) pieces furnished standard for Top and Bottom
 latches. Eight (8) pieces furnished standard for LBR.



*P/N. DXKG8010**
 For DXAS103 Rim strike
 Two (2) pieces furnished
 standard



*P/N. DXKG8020**
 For DXAS203 Strike
 Two (2) pieces furnished
 standard

Fastener/Sex Nut Bolts (SNB)



DXKB1024
(No. 10-24)

DXKB4120
(No. 1/4-20)

Specify Sex Nut Bolts (SNB) where recommended or when required by the door manufacturer.

Sex Nuts Bolts (SNB) are furnished with DXKB1024 (No. 10-24) for device or DXKB4120 (No. 1/4-20) for top rod latch and bottom rod latch. Can accommodate doors up to 2 1/4" (57 mm) thick.

	Devices No.	Specification	Qty.
Without Trim	DX2PR/FR	DXKB1024 (No.10-24)	2
		DXKB4120 (No.1/4-20)	2
	DX2PV/FV	DXKB1024 (No.10-24)	2
		DXKB4120 (No.1/4-20)	6
	DX2PC/FC	DXKB1024 (No.10-24)	2
		DXKB4120 (No.1/4-20)	2
DX2PW/FW	DXKB1024 (No.10-24)	2	
	DXKB4120 (No.1/4-20)	6	
With Trim	DX2PR/FR	DXKB1024 (No.10-24)	2
		DXKB4120 (No.1/4-20)	4
	DX2PC/FC	DXKB1024 (No.10-24)	2
		DXKB4120 (No.1/4-20)	4

Auxiliary Fire Bolt/Latch





P/N. DXAFL
 Heat activated. Used in Less Bottom Rod (L)
 option for fire exit devices. Included when
 ordering Less Bottom Rod (L) option.
 For door openings up to (WXH) 8x8 ft.



Accessories

Top Rods

	Part No.	Rod Length	
	DXAVRT020	36 1/8" (916mm)	Surface rod included with size 36 exit device
	DXAVRT030	48 1/8" (1221mm)	Surface rod included with size 48 exit device
	DXAVRT030 Add DXAVRT040†	48 1/8" (1221mm) Add 24" (609mm)	Extension rod, surface
	DX1ACRT070	37" (940mm)	Concealed rod included with size 37 exit device
	DX1ACRT080	49" (1245mm)	Concealed rod included with size 48 exit device
	DX2ACRT080 Add DX2ACRT050†	49" (1245mm) Add 23 7/8" (605mm)	Extension rod, concealed



Top Rod Selection Guide

Door Width	Door Height	Device Size	Additional Surface Rod	Additional Concealed Rod
36in (914 mm)	7ft (213 cm)	37	none	none
36in (914 mm)	8ft (244 cm)	37	DXAVRT030 ²	DXACRT080 ²
36in (914 mm)	9ft (274 cm) ¹ , 10ft (305 cm) ¹	37	DXAVRT030 ² + DXAVRT040 ³	DXACRT080 ² + DXACCRT050 ³
48in (1219 mm)	7ft (213 cm)	48	none ³	none ³
48in (1219 mm)	8ft (244 cm)	48	none	none
48in (1219 mm)	9ft (274 cm) ¹ , 10ft (305 cm) ¹	48	DXAVRT040 ³	DXACCRT050 ³

(1) Not for use with fire-rated devices. (2) Replace included top rod. (3) Top rod may need to be cut and/or tapped to fit.

Bottom Rods



For exit device location at 39 5/8" (1006mm) from finished floor

	Part No.	Rod Length	
	DXAVRB010	31 7/8" (807 mm)	Included with DX2 PV/FV DX2 FW/FW
	DX2ACRB010*	34 3/32" (870 mm)	Included with DX2 PC/FC

Cylinders

Cylinders are not furnished standard with the device or trim and must be specified when required. Cylinders are Schlage® C keyway, 6-pin standard, and are available in satin chrome (626) finish. Interchangeable Cores (SFIC) are also available.

Please consult your local sales representative prior to specifying to ensure proper selection or for additional keying services.

Cylinder type	Trim Application	Exit Device Applications	Cylinder	Cyl. Length (Part/no.)	Cylinder Cam
Mortise Cylinder 	DX2TE	08 / 11 for DX2PR/FR, DX2PV/FV, DX2PC/FC, DX2PW/FW	Standard	1½" (MC118)	DXACB
			SFIC (6-pin) SFIC (7-pin)**	1¼" (DXAICMH114F†) 1⅝" (DXAICMH138F†)	F*
	All Devices	Cylinder Dogging or Electrified Function	Standard	1¼" (MC114)	DXACA
			SFIC	1⅝" (DXAICMH138E†)	E*
Rim Cylinder 	DX2TPR	03 for DX2PR/FR, DX2PV/FV, DX2PC/FC, DX2PW/FW (Must use with Cylinder Collar Part/No.817D)	Standard	2⅜" Tailpiece (MR118)	
			SFIC	1¾" Tailpiece (9807H)	
	DX2TE	03 / 09 / 12 for DX2PR/FR, DX2PV/FV, DX2PC/FC, DX2PW/FW	Standard	2⅜" Tailpiece (MR118)	
			SFIC	1¾" Tailpiece (9807H)	

† Special order - will require additional lead time and/or minimum order quantities.

* Fixed cam, not available separately. ** 7-pin SFIC will require a cylinder guard (#DXACG1 or #DXACG2)

Cylinder Cam

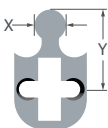
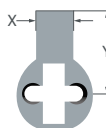
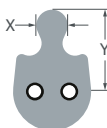
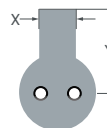
Cam No.	DXACA	DXACB	E*	F*
Illustration				
Dimension	X=0.250" (6 mm) Y=0.625" (15 mm)	X=0.375" (9.5 mm) Y=0.750" (19 mm)	X=0.250" (6 mm) Y=0.625" (15 mm)	X=0.375" (9.5 mm) Y=0.750" (19 mm)

* Fixed cam, not available separately



Cylinder Collar

P/N: 817D
For use with DX2TPR03



SFIC Core

Interchangeable cores are included with housings.

Specify, 6 or 7 pin, uncombined (0-bitted) or less core.

Please contact your local sales representative for details and keying services.

Electrified

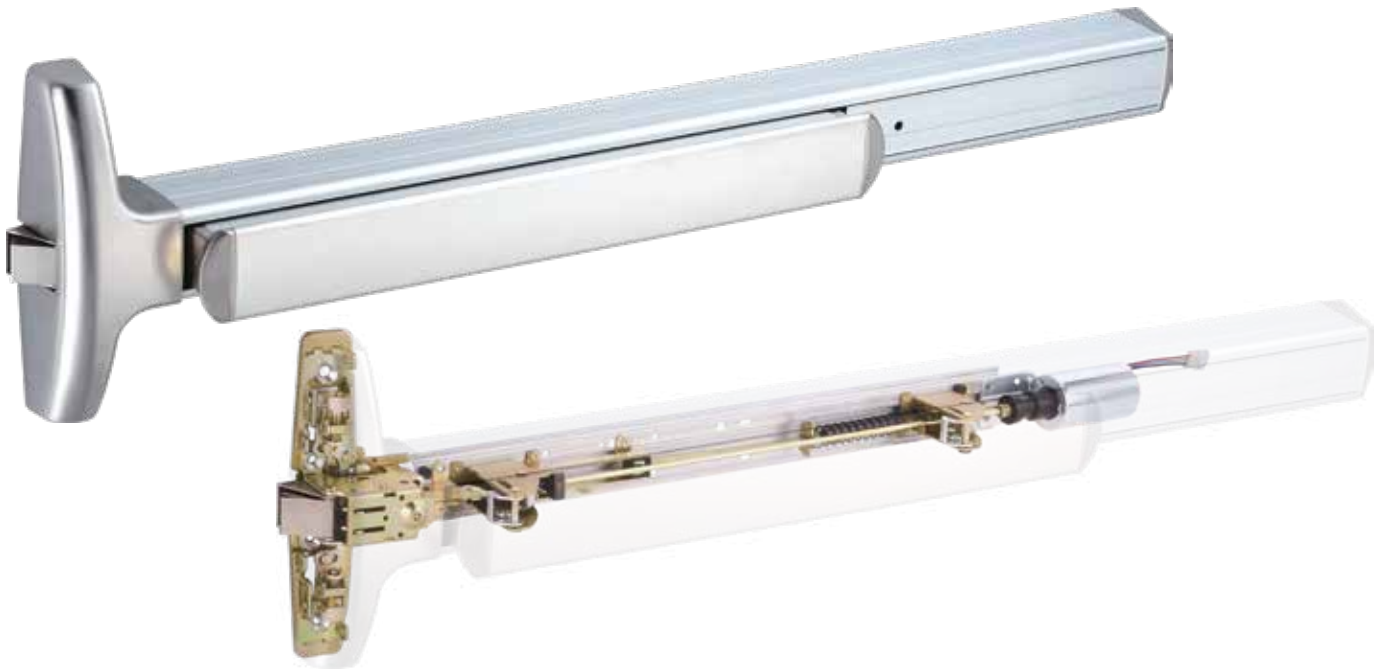

EL

Electrical Latch Retraction / Dogging

Electrical Latch Retraction / Dogging (EL) provides the ability to retract the exit device latch. When a signal is sent to the device, either from a reader or from some other electric signal switch, the latch is retracted momentarily allowing the door to be pulled open.

The latch can also be held retracted for a longer period (electric dogging). This can be set up with the access control system so that the device is on a schedule. At the beginning of the day the latch can be retracted and held open for business hours and then released and secure for closing time at the end of the day.

The DX2 EL uses a solenoid to retract and hold the latch. When power is cut during a power failure, the solenoid releases the latch to secure the opening (Fail Secure).

A power supply and wire transfer are required (sold separately).

Features:

- cULus Listed for Panic and Fire Exit Hardware.
- Panic model includes manual flat key dogging.
- Available configurations include:
 - » with Latch Monitoring switch (ELM)
 - » with Signal Switch (ELS)
 - » with Request-To-Exit switch (ELR)
 - » with Request-To-Exit and Latch Monitoring switches (ELX)

See installation instructions for wiring diagrams.

Solenoid Specifications:

- Current (In Rush - 0.3 seconds): 24VDC, 16 A
- Current (Continuous): 24VDC, 0.25 A

Availability:

- For all DX2 Exit Devices.

To order:

- See How To Order, p. 30.



Electrified



SS

Signal Switch

Uses a micro switch built into the exit device to monitor the push bar assembly of the device. When pressed, the exit device will sound an alarm and send a signal to any other connected device or system.

The keyed mortise cylinder activates or deactivates the signal switch function. Mortise cylinder is a standard $1\frac{1}{32}$ " (29.4mm) diameter cylinder, $1\frac{1}{4}$ " (31.7 mm) long, with a straight cam (DXACA) - refer to page 23 for details.

A power supply and wire transfer are required (sold separately).

EMERGENCY EXIT • **SORTIE DE SECOURS**
PUSH TO OPEN & SOUND ALARM PUSSEZ POUR OUVRIR ET SONNER L'ALARME

Push bar label.

Features:

- cULus Listed for Panic and Fire Exit Hardware.
- Keyed mortise cylinder not included, see p. 23.
- Push bar label included.

See installation instructions for wiring diagrams.

Specifications:

- Switch Rate: 24VDC, 2A (per switch)
(SPDT – Single Pole, Double Throw)

Availability:

- For all DX2 Exit Devices.

To order:

- See How To Order, p.30.



Electrified



AL

Alarm Exit

Alarm Exit (or Exit Alarm) devices can be powered by battery or wired directly to a power supply. Once the push bar is pressed, an 85db alarm will sound and immediate exit will be granted.

When powered by battery, a 9-volt battery is used (not included). When at low power, the integrated horn will sound intermittently to indicate a battery change is required.

When hardwired, a power supply and wire transfer are required, sold separately.

The keyed mortise cylinder activates/deactivates the alarm function or silences the alarm when activated. Cylinder is not included, sold separately. Refer to page 23 for details.

The circuitry included inside an AL equipped device allows the exit device to work with a centralized alarm system or independently from it. AL equipped exit devices are available with one of two circuits:

- **External Inhibit** allows the use of external switch to be used to arm, disarm, and reset the alarm. This circuit is included by default.
- **Auto Reset (R)** rearms the alarm after a preset time. AR default setting time is 5 minutes and can be manually switched to 1½ or 3 minutes.

Features:

- cULus Listed for Panic and Fire Exit Hardware.

EMERGENCY EXIT
 PUSH TO OPEN – ALARM WILL SOUND
SORTIE DE SECOURS
 Poussez pour ouvrir – ALARME SONNERA

Door label.

- Keyed mortise cylinder not included, see p. 23.
- Door label included.

See installation instructions for wiring diagrams.

Specifications:

- Current: 12-24V (AC or DC), 0.2A
- Battery: 9V
- Normally Open Input: External Inhibit

Availability:

- For all DX2 Exit Devices.

To order:

- See How To Order, p. 30.

The alarm exit is also available in kits for retrofit on existing DX2 devices - see ordering chart below.



DX2		KA	L	3	-	630
SERIES	STYLE	TYPE	MONITOR	SIZE	FINISH	
						630 - SATIN STAINLESS STEEL (32D)
						626 - SATIN CHROME (26D)*
						613 - OIL RUBBED BRONZE (10B)*
						605 - POLISHED BRASS (3)*
				3		3 - 3FT DEVICE
				4		4 - 4FT DEVICE*

SMOOTH SURFACE (DEFAULT)
 G - GROOVED SURFACE*

RX MONITOR (DEFAULT)
 L - LM MONITOR

Electrified

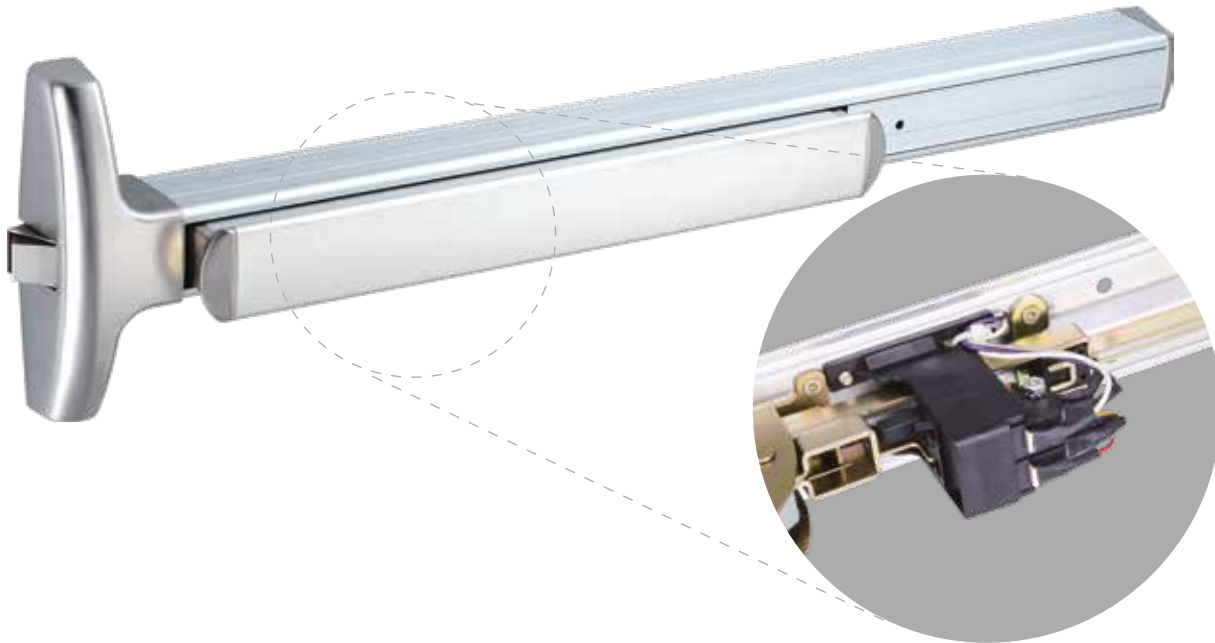

RX

Request to Exit

Uses a micro switch built into the exit device to monitor the push bar assembly of the device. When pressed, the exit device will send a signal to a centralized system, electric strike, electromagnetic lock, or other connected electrified device requiring a Request-To-Exit input.

A power supply and wire transfer are required (sold separately).

Request-to-Exit with Latch Monitoring switch (RXM) also available.

Features:

- cULus Listed for Panic and Fire Exit Hardware.

See installation instructions for wiring diagrams.

Specifications:

- Switch Rate: 24VDC, 3A
(SPDT – Single Pole, Double Throw)

Availability:

- For all DX2 Exit Devices.

To order:

- See How To Order, p. 30.



LM

Latchbolt Monitoring

Uses a micro switch built into the exit device to monitor the latchbolt of the device. When pressed or released, the monitor switch will send a signal to a centralized system, electric strike, electromagnetic lock, or other connected electrified device requiring an input.

A power supply and wire transfer are required (sold separately).

Features:

- cULus Listed for Panic and Fire Exit Hardware.

See installation instructions for wiring diagrams.

Specifications:

- Switch Rate: 24VDC, 3A
(SPDT – Single Pole, Double Throw)

Availability:

- For all DX2 Exit Devices.

To order:

- See How To Order, p. 30.



Electrified



DE

Delayed Egress Device

DX2 exit devices that are installed with the delayed egress (DE) function are used when an emergency exit needs to be delayed for a short time. This is usually done to allow security personnel to verify if the person attempting to exit should be using that exit or not.

When someone pushes against the push bar, a signal will be sent to a connected security system or device, an alarm will sound, and a timer will begin to countdown from 15 (or 30) seconds. After the time has expired the device will allow passage through the opening.

The keyed mortise cylinder activates/deactivates or rearms the DE function. Cylinder is not included, sold separately. Refer to page 23 for details.

A power supply and wire transfer are required (sold separately).

Operation Example: When locked, the exit device LED indicator is on. Depressing the push bar by accident, for less than the nuisance delay time, will sound the audio alarm without initiating the alarm sequence. Depressing the push bar with less than 15 pounds pressure, for longer than the nuisance delay time, will initiate an irreversible local audible beeping tone and the LED indicator will flash until the device releases. After the 15 second delay time, the lock releases and the alarm changes to a steady tone which continues to sound until reset. The remote monitoring contact output on the device can be used to alert security personnel.

Features:

- ULus Listed for Panic and Fire Exit Hardware (US only).
- Nuisance delay to prevent accidental activation.
- LED lock status light.
- Keyed mortise cylinder not included, see p. 23.
- Door label (15 seconds) included.
- 30 Second delay model available (DE3).

See installation instructions for wiring diagrams.

Specifications:

- Current (In Rush): 24VDC, 16A, 0.3 seconds
- Current (Continuous): 24VDC, 0.37A

Availability:

- For all DX2 Exit Devices.

To order:

- See How To Order, p. 30.



PUSH UNTIL ALARM
DOOR CAN OPEN IN 15 SECONDS
POUSSER JUSQU'À L'ALARME
PORTE PEUT OUVRIR EN 15 SECONDES

Door label.

How To Order

EXIT DEVICE

DX	2	AL	P	V	L	37	C	-	630	H	
SERIES	STYLE	ELECTRIC	RATING	TYPE	ROD/LATCH	SIZE	DOGGING		FINISH	STRIKE	
BLANK = NOT REQUIRED (IE: DUMMY) 1 - WIDE HEAD, SMOOTH SURFACE G1 - WIDE HEAD, GROOVED SURFACE* SEE P.4						3 - 3FT DEVICE 4 - 4FT DEVICE 37 - 3FT DEVICE, 7FT DOOR* 48 - 4FT DEVICE, 8FT DOOR* FOR TALLER DOORS SEE P.22					
BLANK = NOT REQUIRED AL - ALARM EXIT (RX)* AM - ALARM EXIT (LM)* AX - ALARM EXIT (LM+RX)* ALA - ALARM EXIT (RX) AUTO-RESET* AMA - ALARM EXIT (LM) AUTO-RESET* AXA - ALARM EXIT (LM+RX) AUTO-RESET* DE - DELAYED EGRESS (15 SEC)* DE3 - DELAYED EGRESS (30 SEC)* EL - ELEC. LATCH RETRACTION* ELR - ELEC. LATCH RET. (+RX)* ELS - ELEC. LATCH RET. (+SS)* ELM - ELEC. LATCH RET. (+LM)* ELX - ELEC. LATCH RET. (+LM+RX)* LM - LATCHBOLT MONITORING* RX - REQUEST TO EXIT* RXM - REQUEST TO EXIT (+LM)* SS - SIGNAL SWITCH* SEE P.25-29		P - PANIC EXIT F - FIRE EXIT		R - RIM V - SURFACE VERTICAL ROD* C - CONCEALED VERTICAL ROD W - 3 POINT* D - DUMMY, INACTIVE* DA - DUMMY, ACTIVE* SEE P.7-10		BLANK = (PANIC DEFAULT) HEX KEY DOGGING (FIRE DEFAULT) LESS DOGGING C - CYLINDER DOGGING* (CYLINDER NOT INCLUDED) L - LESS DOGGING*		BLANK = DEVICE DEFAULT (SEE P.7-11) A - DXA106 B - DXA108 C - DXA136* P - DXA203* D - DXA215* SEE P.19-20		E - DXA216 F - DXA224* G - DXA225* H - DXA226* J - DXA227/227F	
				BLANK = NOT REQUIRED OR DEFAULT (PULLMAN LATCH) L - LESS BOTTOM ROD* R - ROUND BOTTOM LATCH*							

DEVICE TRIM

DX	2	TE	R	A	09	LHR	SC	KD	6	-	630
SERIES	STYLE	TRIM	DEVICE	DESIGN	FUNCTION	HANDING	KEYWAY	KEYING	PINS		FINISH
1 - NARROW STILE DEVICE								BLANK = NOT REQ. 5 - 5 PINS* 6 - 6 PINS* 7 - 7 PINS*			
TP - PULL TRIM* TE - ESCUTCHEON TRIM SEE P.14-17								BLANK = NOT REQUIRED KD - KEYED DIFFERENT KA - KEYED ALIKE* KA2 - KEYED ALIKE, PAIR*			
R - RIM, VERTICAL OR 3-POINT								BLANK = NOT REQUIRED SC - SCHLAGE C IA - SFIC A* IAZB - SFIC A, 0-BITTED* IALC - SFIC A, LESS CORE* SEE P.23			
BLANK = DEFAULT STYLE K - PULL GRIP K* Q - ESCUTCHEON LEVER Q* A - ESCUTCHEON LEVER A* K - ESCUTCHEON LEVER K* SEE P.14-17				01 - TP / BLANK PLATE* 02 - TP / DUMMY* 03 - TP / NIGHT LATCH* 02 - TE / DUMMY (LEVER)* 03 - TE / NIGHT LATCH* 08 - TE / CLASSROOM (LEVER) 09 - TE / NIGHT LATCH (LEVER) 14 - TE / PASSAGE (LEVER)* 11 - TE / STOREROOM (THUMB TURN)* 12 - TE / NIGHT LATCH (THUMB TURN)* 16 - TE / PASSAGE (THUMB TURN)* SEE PAGES 14-17		BLANK = (RHR) RIGHT HAND REV. BY DEFAULT LHR - LEFT HAND REV.		BLANK = NOT REQUIRED 630 - SATIN STAINLESS STEEL (32D)* 626 - SATIN CHROME (26D) 625 - POLISHED CHROME (26)* 613 - OIL RUBBED BRONZE (10B)* 612 - SATIN BRONZE (10)* 611 - POLISHED BRONZE (9)* 606 - SATIN BRASS (4)* 605 - POLISHED BRASS (3)* SEE P.4			

* SPECIAL ORDER - WILL REQUIRE ADDITIONAL LEAD TIME AND/OR MINIMUM ORDER QUANTITIES.



Warranty

DOREX warrants to the original purchaser that all products provided by it shall be free of defects in material and workmanship regarding Mechanical Exit Devices & Trims (5 years), Electrified Products (1 year) and finishes (1 year). The present warranty does not cover scratches, abrasions, deterioration due to the use of paints, solvents and other chemicals, normal wear and tear, abuse or any damage caused by improper installation or misuse of the product. Furthermore, the cost incurred in removing a defective product and installing a replacement product is not included in the warranty. Upon return of a defective product, DOREX may repair or replace the product.

Note: The warranty becomes effective from the date of shipment.



CAUTION: Any retrofit or other field modification to a fire-rated opening can potentially impact the fire rating of the opening, DOREX makes no representations or warranties concerning what such impact may be in any specific situation. When retrofitting any portion of an existing fire rated opening, or specifying and installing a new fire-rated opening, please consult with a code specialist or local code official (Authority having jurisdiction) to ensure compliance with all applicable codes and ratings.

It is important that only DX2 strikes and latches be used with DX2 exit devices. The use of third party or previously installed strikes is not recommended and may hamper performance and/or invalidate hardware certifications. As above, please consult with a code specialist or local code official (Authority having jurisdiction) to ensure compliance with all applicable codes and ratings.

DOREX[®]



1400 SERIES

NARROW STILE EXIT DEVICE



- Certifications**
 - cUL listed, Panic Exit
 - 1 Year limited warranty
- Rail Assembly**
 - High strength aluminum extrusion
 - Field sizable
- Handing**
 - 1400PR: Handed (field reversible)
 - 1400PV: Non handed
- Door Size**
 - 30-36x84" (762-914x2134 mm)
 - 36-42x84" (914-1067x2134 mm) – option
- Door Thickness**
 - 1¾" (45 mm)
 - 2" (51 mm) and 2¼" (57 mm) – available*

Recommended for aluminum doors () Rim model only.*
- Stile Width**
 - 1¾" (44.5 mm) minimum

Measured from door edge
- Projection**
 - 2¾" (70 mm) from door surface
- Lock Case**
 - Heavy duty steel deadlatch mortise lock
 - Adjustable mounting posts
 - 1½" (28.6 mm) backset
 - Anodized aluminum flat faceplate
- Cylinder**
 - Not included, sold separately
- Latchbolts**
 - 1400PR: Stainless steel deadlatch
 - 1400PV: Stainless steel top & bottom latches
- Vertical Rods**
 - For 84" (2134 mm) door

1400PV36 concealed vertical rod model only
- Dogging**
 - Hex key dogging
- Hardware**
 - Machine screws
- Finish**
 - AL–Aluminum; DU–Dark bronze;
 - MB–Matte black

Other finishes available by special order

1400PR	36	LHR	-	AL
MODEL ¹	SIZE ¹	HAND ²		FINISH

(1) SEE SELECTION GUIDE (2) FOR 1400PR INDICATE: LHR–LEFT HAND REVERSED, RHR – RIGHT HAND REVERSED; OMIT FOR 1400PV

SELECTION GUIDE

MODEL		SIZE	DOOR SIZE ¹	DOGGING	FINISH	/CASE
1400PR	Panic Exit Hardware Mortise Rim. Indicate required handing.	36	30-36x84 (762-914x2134)	•	AL, DU, MB	6
		42	36-42x84 (914-1067x2134)	•	AL, DU, MB	6
1400PV	Panic Exit Hardware Concealed Vertical Rod. Non-handed.	36	30-36x84 (762-914x2134)	•	AL, DU	6

(1) RECOMMENDED DOOR SIZE, IN (MM), FOR NON-STANDARD SIZES OR INSTALLATIONS PLEASE CONTACT.

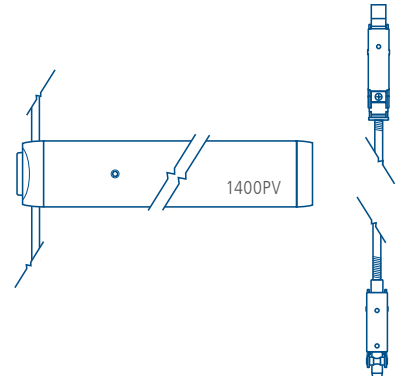
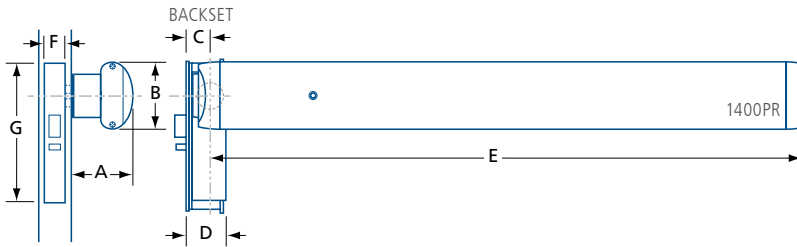

MODEL	A	B	C	D	E ¹	F	G
1400PR/PV 36	2 3/4 (70)	3 1/16 (78)	1 1/8 (28.6)	1 3/4 (44.5)	33 7/8 (860)	1 (25.4)	6 3/4 (171)
1400PR 42					39 7/8 (1013)		

IN(MM) (1) CAN BE CUT TO SIZE - SEE PRODUCT INSTALLATION INSTRUCTIONS

PARTS & ACCESSORIES



CBM118A
Mortise cylinder, 1 1/8" (28.6mm) long,
with cam A.



CMCAMA
Adams Rite-type cam.



1400ARCAM
1400AR exit device cam.



1400KVE
Mortise cylinder escutcheon mount.
Aluminum (-AL) or Dark bronze (-DU) finish.



EXTENSION KIT GUIDE

Use chart below to determine required extension kit
for 1400PR Exit Device only.

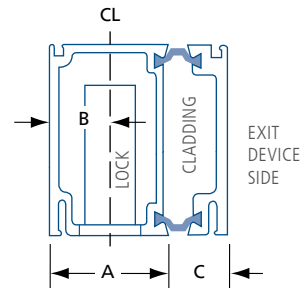

A	B	C	EXTENSION	KIT
2 (51)	1 (25.4)	-	4 mm	1400KRDT200
1 3/4 (44.5)	7/8 (22.4)	1/4 (6.5)	6 mm	1400KRDT225
2 1/4 (57)	1 1/8 (28.6)	-	6 mm	1400KRDT225
1 3/4 (44.5)	7/8 (22.4)	1/2 (12.7)	12 mm	1400KRDT500

IN(MM)



2295 SERIES

NARROW STILE EXIT DEVICE



- Certifications**
- UL listed, Panic Exit
 - 1 Year limited warranty

- Rail Assembly**
- High strength aluminum
 - Field sizable

- Handing**
- Non-handed

- Door Width**
- 30–38" (762–965 mm)
 - 36–44" (914–1118 mm) –option

- Door Thickness**
- 1 3/4" (45.5 mm)

Recommended for aluminum doors

- Stile Width**
- 1 3/4" (44.5 mm) minimum

Measured from door edge

- Projection**
- 2 1/16" (67 mm) from door surface

- Latchbolt**
- Stainless steel, 5/8" (15,9 mm)

- Strike**
- Steel, roller strike #2295S

- Dogging**
- Hex key dogging

- Hardware**
- Machine screws

- Trims**
- Escutcheon trim – available

Sold separately, see 2295TE

- Finish**
- 20D–Dark bronze; 28–Aluminum

Other finishes available by special order

2295PR	3	–	28
MODEL	SIZE		FINISH

SELECTION GUIDE

MODEL		SIZE	DOOR WIDTH ¹	DOGGING	FINISH	/CASE
2295PR	Panic Exit Hardware Rim Device	3	30-38 (762-965)	●	20D, 28	4
		4	36-44 (914-1118)			

(1) RECOMMENDED DOOR WIDTH, IN (MM), FOR NON-STANDARD SIZES OR INSTALLATIONS PLEASE CONTACT.

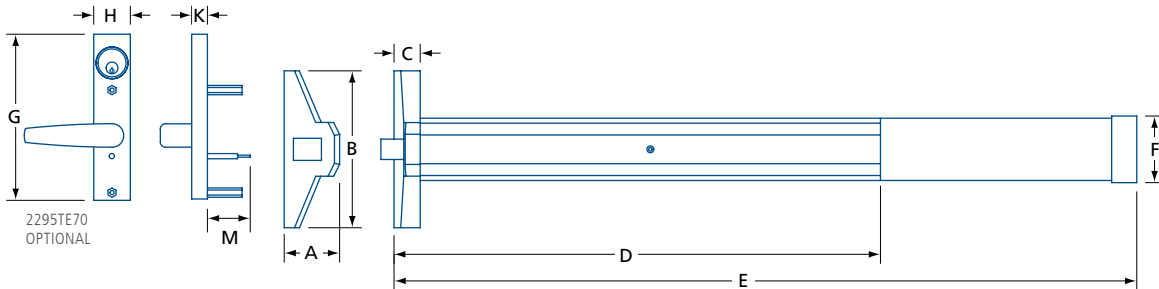

MODEL	A	B	C	D	E ¹	F	G	H	K	M
2295PR3	2 11/16 (67)	7 1/2 (191)	1 1/4 (32)	23 1/4 (591)	35 1/2 (902)	3 3/16 (81)	7 15/16 (201.6)	1 3/4 (44)	3/4 (19)	2 1/16 (52)
2295PR4					41 1/2 (1054)					

IN (MM) (1) CAN BE CUT TO SIZE - SEE PRODUCT INSTALLATION INSTRUCTIONS

2295TE ESCUTCHEON TRIM



Trim	2295TE70
Function	Entrance/Classroom
Finish	20D-Dark bronze, 28-Aluminum
Lever	Straight, no return
Cylinder ¹	1 1/4 (32) mortise
Door Thickness	1 3/4 (44.5)
Warranty	1 Year limited

IN (MM) (1) SOLID BRASS, 6-PIN CYLINDER, SCHLAGE "C", 2 KEYS INCLUDED - KEYING SERVICES AVAILABLE

PARTS & COMPONENTS



2295S
Standard roller strike.

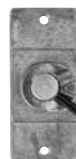

2295AD
Dogging mechanism.





LEFT HAND REVERSE MODEL SHOWN

- Certifications**
- Conforms to ANSI/BHMA A156.3, Grade 2
 - cUL listed, Panic Exit
 - 1 Year limited warranty

Handing • Handed, reversible

Door Thickness • 1 3/4" (45.5 mm)

Stile Width • 4 3/4" (121 mm) minimum
Measured from door edge

Projection • 4 3/4" (121 mm) from door surface

Latchbolt • Solid brass, 3/4" (19mm)

Crossbar

- Field sizable
- 38" (965 mm) steel tube
- 48" (1219 mm) steel tube – available

Strike • Steel, standard type (NHT10)

Dogging • Hex key dogging

Hardware • Wood and machine screws

Functions

- 1 Exit only, no trim
- 3 Passage with pull trim
- 4 Night latch with pull trim*
- 5 Entrance with thumbpiece trim*

(*) Keyed functions use standard rim cylinder, sold separately

Finish Aluminum

Other finishes available by special order

NH900	-3
MODEL	FUNCTION ¹

(1) SEE SELECTION GUIDE FOR DETAILS **PLEASE INDICATE REQUIRED HANDING WHEN ORDERING

SELECTION GUIDE

MODEL	FUNCTION	DOGGING	FINISH	/CASE	
NH900-1	Exit only, no exterior trim.	#1	●	Aluminum	12
NH900-3	Passage with pull trim. Latch always free.	#3	●	Aluminum	6
NH900-4	(Night Latch) Entrance with pull trim. Always locked. Latch operated by exterior rim cylinder.*	#4	●	Aluminum	6
NH900-5	Entrance with thumbpiece trim. Latch operated by thumbpiece, unless locked by exterior rim cylinder.*	#5	●	Aluminum	6

(*) RIM CYLINDER NOT INCLUDED, SOLD SEPARATELY. CBR114 OR MR118 RIM CYLINDERS RECOMMENDED.

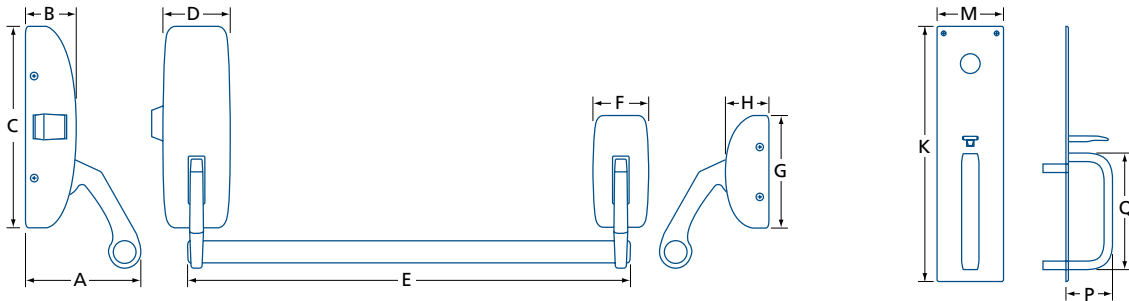

MODEL	A	B	C	D	E ¹	F	G	H	K	M	P	Q
NH900-1	4¾	2⅛	8½	2⅛	38	2¾	4⅝	2	—	—	—	—
NH900-3/4/5	(121)	(54)	(216)	(68)	(965)	(55)	(117)	(51)	16 (406)	3½ (89)	2⅛ (52)	7½ (190)

IN (MM) (1) CAN BE CUT TO SIZE - SEE PRODUCT INSTALLATION INSTRUCTIONS

PARTS & COMPONENTS



NH911
Crossbar end cap with screw.



NH912
Conversion kit, function #1 to #5.

NH913
Conversion kit, function #1 to #4.



NH914
Exterior pull trim, function #4.
Included with NH900-4.

NH915
Exterior thumbpiece trim, function #5.
Included with NH900-5.



NH926
38" (965mm) steel crossbar tube, chrome

NH926-48
48" (1219mm) steel crossbar tube, chrome



NHST10
Standard strike for panic rim device.



NHST11
Overlapping strike for double doors without mullion. See instructions for details.



NH990
Dogging screw

NH995
Coil spring for bar levers

NH998
Latch spring



CBR114-SCKD
6-pin, brass rim cylinder with aluminum clad face. 1¼" (32 mm) long with 2⅞" (62 mm) tailpiece. Schlage keyway.

MR118-SCKD6
6-pin, brass rim cylinder with aluminum clad face. 1⅝" (28.6 mm) long with 2⅞" (62 mm) tailpiece. Schlage keyway.

SEE PAGE 05.410 FOR DETAILS





- Certifications**
- cUL listed, Panic Exit
 - 1 Year limited warranty

- Handing**
- 1185: Non-handed (concealed vertical rod)
 - 1195: Handed (rim)

- Door Size**
- 30–36x84" (711–914x2134mm)
- For doors 36x48" (914x1219mm) order #1185-48 crossbar, sold separately*

- Door Thickness**
- 1 3/4" (45.5 mm)
- Recommended for aluminum doors*

- Stile Width**
- 1 3/4" (44.5 mm) minimum
- Measured from door edge*

- Projection**
- 4 5/8" (118 mm) from door surface

- Latchbolts**
- Zinc alloy, 1/2" (12.7 mm)

- Vertical Rods**
- Standard for 7' (2134mm) door
- 1185 concealed vertical rod model only*

- Crossbar**
- Field sizable
 - 36" (965 mm) aluminum extrusion
 - 48" (1219mm) aluminum extrusion – available

- Strike**
- 1185: Standard steel top & bottom strikes
 - 1195: Roller type steel strike #1195S

- Dogging**
- 1185: by outside cylinder
 - 1195: by slotted key

- Hardware**
- Machine screws

- Finish**
- C20D–Dark bronze; C28–Aluminum
- Other finishes available by special order*

1195	C28	LHR
MODEL ¹	FINISH	HAND ²

(1) SEE SELECTION GUIDE (2) LHR –LEFT HAND REVERSED RHR –RIGHT HAND REVERSED

SELECTION GUIDE

MODEL		DOOR SIZE ¹	DOGGING ²	FINISH	/CASE
1185	Panic exit hardware concealed vertical rod crossbar, non-handed	30–36x84 (762–914x2134)	•	C20D, C28	6
1195	Panic exit hardware rim crossbar, handed	30–36x84 (762–914x2134)	•	C20D, C28	6

(1) RECOMMENDED DOOR SIZE, IN (MM), FOR NON-STANDARD SIZES OR INSTALLATIONS PLEASE CONTACT. (2) 1185: BY CYLINDER 1195: BY SLOTTED KEY

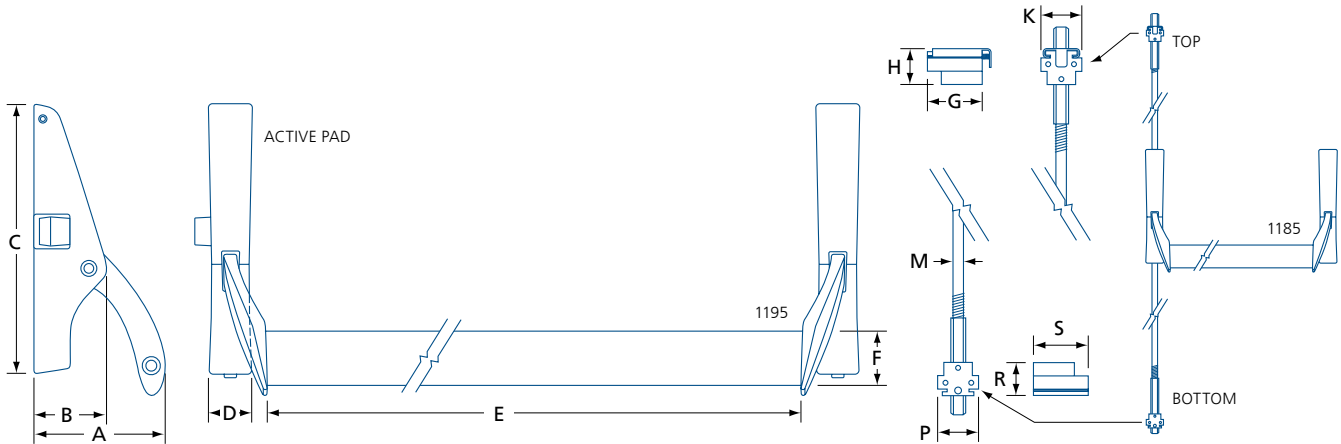

MODEL	A	B	C	D	E ¹	F	G	H	K	M	P	R	S
1185	4 ⁵ / ₈ (117)	2 (51)	7 ³ / ₈ (187)	1 ¹ / ₄ (32)	36 (914)	1 ¹ / ₂ (38)	1 ¹ / ₂ (38)	1 (25)	1 ³ / ₃₂ (28)	∅ 3 ¹ / ₈ (9.5)	1 ³ / ₃₂ (28)	1 ⁵ / ₁₆ (24)	1 ¹ / ₂ (38)
1195							—	—	—	—	—	—	—

IN (MM) (1) CAN BE CUT TO SIZE; 48" (1219MM) BAR AVAILABLE

PARTS & COMPONENTS

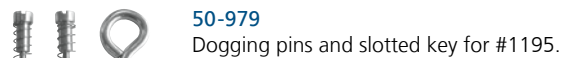
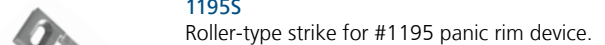
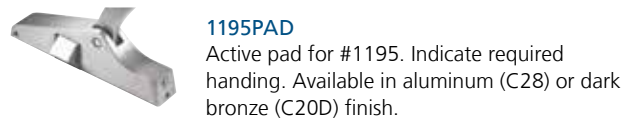
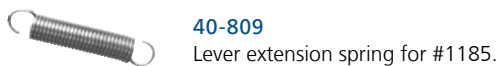
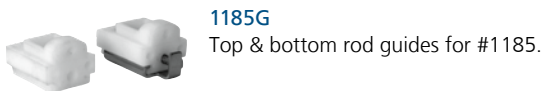
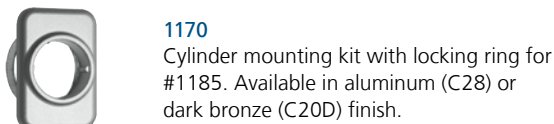
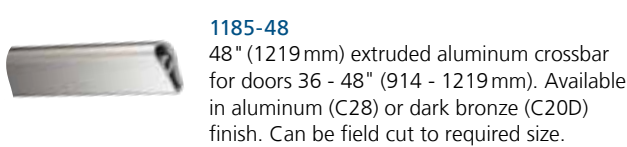

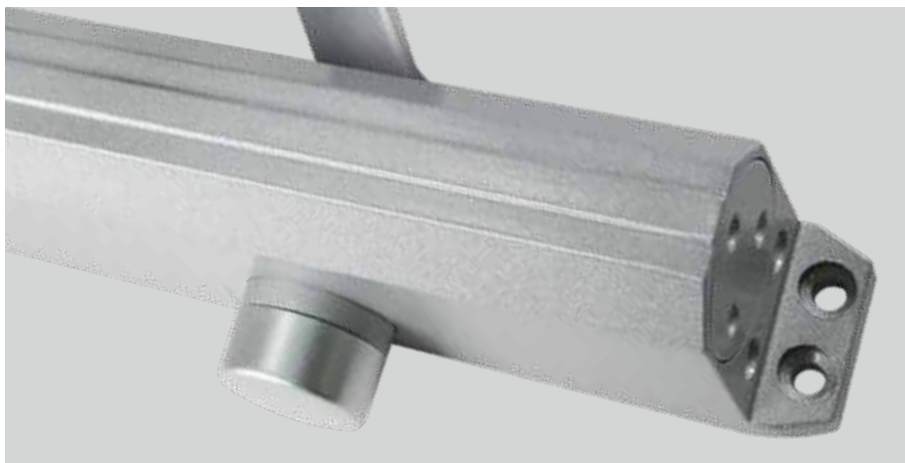

DOOR CONTROL TABLE OF CONTENTS

Door Closer Guide	ii
Door Closer Features.....	ii
Door Handing Guide.....	ii
Finish Guide.....	iii
Abbreviation Guide.....	iii

SURFACE DOOR CLOSERS

DOREX 441HD Series, Heavy Duty, Grade 1	03.005
DOREX 441 Series, Grade 1	03.006
DOREX 1901 Series, Grade 1 BHMA	03.010
DOREX 1900 Series, Grade 1	03.011
DOREX 1701 Series, Grade 1 BHMA	03.022
DOREX 1700 Series, Grade 1	03.024
DOREX 1761 Series.....	03.026
DOREX 851 Series, Grade 1 BHMA	03.030
DOREX 700 Series.....	03.040
D8DIVISION8 300 Series.....	03.044
D8DIVISION8 DC300 Series.....	03.045
TC603 Series.....	03.046

CONCEALED DOOR CLOSERS

DOREX DC3000 Series, Concealed in door.....	03.051
DOREX 30 Series, Concealed in transom	03.052
DOREX 40 Series, Concealed in floor.....	03.054
Concealed Spring Closers.....	03.056
PF100 Hydraulic Patch Fitting Closer	03.060
PF102 Hydraulic Patch Fitting Closer	03.062

AUXILIARY

Door Check	03.072
------------------	--------

OVERHEAD HOLDERS & STOPS

Concealed	03.100
Surface Mounted.....	03.102

DOOR COORDINATORS

Surface Mounted.....	03.200
Gravity Coordinator	03.201
Mullion.....	03.210

ELECTROMAGNETIC DOOR HOLDERS

Wall Mounted.....	03.300
Floor Mounted.....	03.301

R2026A10



DOOR CLOSER GUIDE

REGULAR MOUNT
(PULL SIDE)

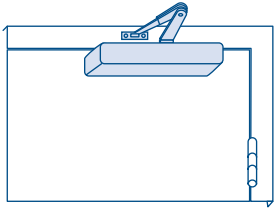

TOP JAMB MOUNT
(PUSH SIDE)

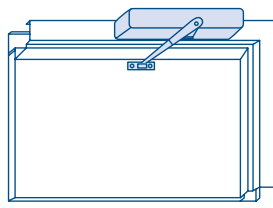

PARALLEL MOUNT
(PUSH SIDE)

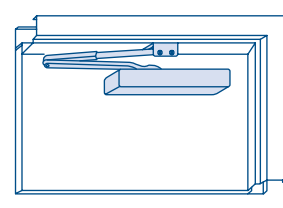

DOOR CLOSER FEATURES

SWEEP / LATCH SPEED

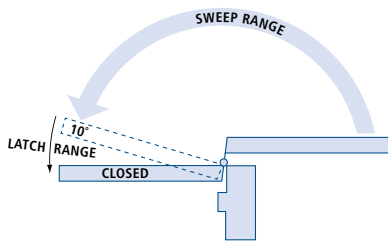

DELAYED ACTION

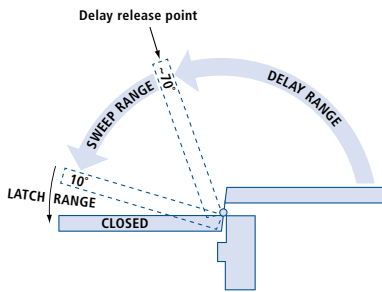

BACKCHECK

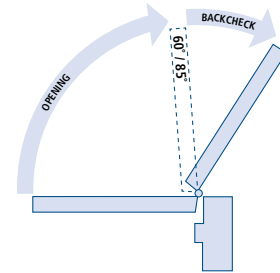

NOTE: CUSHIONING BACKCHECK DOES NOT REPLACE A PHYSICAL DOOR STOP.

DOOR HANDING GUIDE

LEFT HAND (LH)

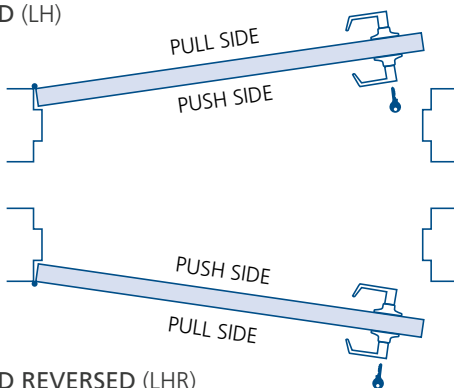

RIGHT HAND (RH)

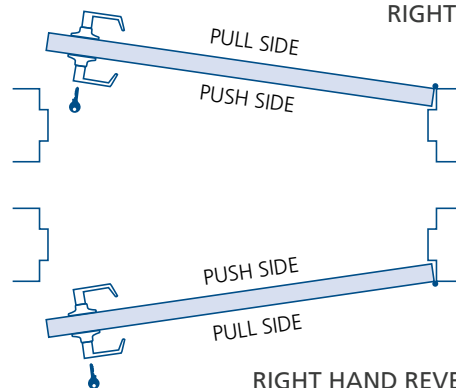







LEFT HAND REVERSED (LHR)

RIGHT HAND REVERSED (RHR)

PLEASE CONTACT OUR DOOR HARDWARE SPECIALISTS IF YOU HAVE ANY QUESTIONS CONCERNING OUR PRODUCTS OR NEED ASSISTANCE IN SELECTING THE CORRECT DOOR HARDWARE FOR YOUR APPLICATION OR SITUATION.

DOOR CONTROL GENERAL INFORMATION

FINISH GUIDE

					
	PAINTED	PLATED PAINTED			
	ALUMINUM	BRASS	DARK BRONZE	MATTE BLACK	SATIN NICKEL
CODE	AL, C28, 28	BP, PB, C3, 3	DJ, C20D, 20D	MB, C19, 19	SDN, SN, C15, 15
BHMA*	628, 689	605, 632, 677	649, 650, 690	622, 631	619, 646
					
	SATIN CHROME	SATIN STAINLESS STEEL	POLISHED STAINLESS STEEL	PLAIN STEEL, NO FINISH	
CODE	SC, C26D, 26D	SS, C32D, 32D	C32, 32	PS, SP	
BHMA*	626, 652	630	629		

ALL FINISHES IMAGES ABOVE ARE PHOTOGRAPHIC OR COLOUR APPROXIMATIONS, DELIVERED PRODUCT MAY VARY IN COMPARISON OR BETWEEN ORDERS/LOTS.

OTHER FINISHES AVAILABLE—PLEASE CONTACT.







(*) EQUIVALENT; CODES DIFFER DEPENDING ON BASE MATERIAL AND/OR FINISH PROCESS.

ABBREVIATION GUIDE

GENERAL

DIA, ∅	Diameter
KG	Kilograms
LBS	Pounds
LH	Left hand
LHR	Left hand reversed
MAX	Maximum
MIN	Minimum
N/A, —	Not applicable / Not available
QTY	Quantity (usually followed by notes)
RH	Right hand
RHR	Right hand reversed
SQ, ∅	Square
WT	Weight
/UNIT	Number of items per basic unit of sale (bagged or boxed)
/BOX, /BAG	Number of UNITS found in an inner carton or bag
/CASE	Number of BOXES or UNITS found in an outer (shipping) carton

LEGEND

	Product, configuration or option meets ADA (Americans with Disabilities Act) requirements.
	GRADE 1 product meets or exceeds standardized testing requirements for high traffic, commercial applications.
	Tested to Canadian and/or American safety and performance standards by Underwriters Laboratories® (UL).
	Certified by the Builders Hardware Manufacturers Association® / American National Standards Institute®.
  	Limited warranty length in years, applicable to mechanical, electronic, or finish aspects of a product.



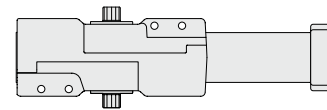

- Certifications**
- Conforms to ANSI/BHMA A156.4, Grade 1
 - cULus listed, 3hr fire-rating
 - ADA compliant, barrier free
 - 15 Year limited warranty
- Power Size**
- Adjustable size 1-6 (preset 3)
- See selection guide for details*
- Body Material**
- Heavy duty precision cast iron body, painted finish
- Mechanism**
- Hydraulic rack and pinion operation
- Fluid**
- Non-gumming, non-freezing hydraulic fluid
 - Operating range of -39° to 49° C (-38° to 120°F)
- Adjustments**
- Sweep speed adjustment valve
 - Latching speed adjustment valve
 - Cushioning backcheck adjustment valve
 - Delayed action adjustment valve
- Cover**
- Full body plastic cover, painted finish
- Handing**
- Non-handed
- Opening**
- 120° maximum
 - 180° maximum with parallel arm

- Mounting**
- Tri-Pack: regular¹, top jamb¹, parallel arm²
 - Maximum reveal: 2¾" (70 mm)
 - Forearm extension³ – available
 - Drop plates – available
- (1) Arm allows 15% power adjustment
(2) May reduce spring power efficiency by 25%
(3) For reveal up to 5" (127 mm)*
- Hardware**
- Wood screws & self-tapping machine screws
 - Sex nuts & thru-bolts
- Available Arms**
- Extra duty parallel arm
 - Heavy duty cushion stop arm, hold open
 - Heavy duty cushion stop arm, no hold open
 - Heavy duty spring stop arm, no hold open
- Finish**
- AL**–Aluminum, painted; **MB**–Matte black, painted
- Other finishes available by special order*

441HD BC – AL
MODEL FINISH

SEE SELECTION GUIDE FOR DETAILS

SELECTION GUIDE

MODEL	POWER SIZE	WEIGHT CAPACITY ¹	MAX. DOOR WIDTH ²		BACKCHECK	DELAYED ACTION	FINISH	/CASE
			INTERIOR	EXTERIOR				
441HDBC REGULAR ARM	1-6	330 (150)	60 (1524)	48 (1219)	■	■	AL, MB	2
441HDBCH CUSHION-STOP ARM, HOLD OPEN*								

CAUTION: ANY DOOR CLOSER INSTALLED AND ADJUSTED BASED ON ADA REDUCED FORCE REQUIREMENTS MAY NOT RELIABLY CLOSE AND LATCH DOOR.
(1) WEIGHT CAPACITY IN POUNDS (KILOGRAMS) (2) MAXIMUM DOOR WIDTH IN INCHES (MILLIMETRES) (*) NOT FOR USE ON FIRE RATED DOORS

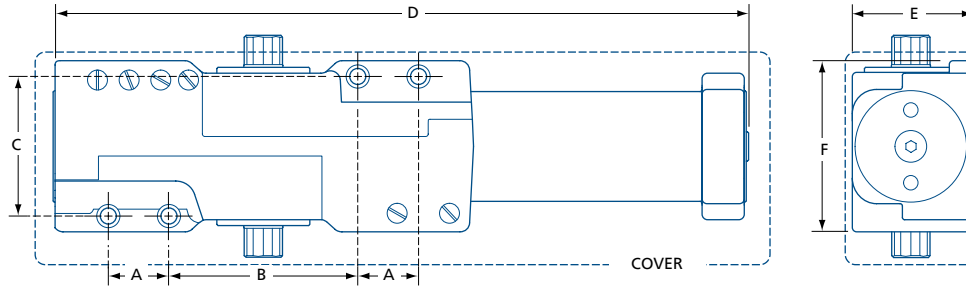

MODEL	A	B	C	D	E	F
441HD	1 (25)	3 (76)	2¼ (57)	11½ (281)	2 (51)	2¾ (70)
441HD with cover	1 (25)	3 (76)	2¼ (57)	12¾ (309)	2¼ (57)	3½ (89)

IN (MM)

PARTS & ACCESSORIES



ARM441HDC
Heavy duty cushion stop arm, no hold open.



ARM441HDH
Heavy duty cushion stop arm, hold open.
Not for use on fire rated doors. *Included with 441HDBCH.*



ARM441HDE
Parallel arm for extra-duty applications.



ARM441HDLR
Long forearm link for reveal greater than 2¾" (70 mm) up to 5" (127 mm).



DP441HD-18PA
For parallel arm installations where the door top rail height is insufficient for direct mounting.



DP441HD-18RG
For regular arm installations where the door top rail height is insufficient for direct mounting OR for top jamb installations where low ceiling prevents direct mounting.



DP441HD-18TJ
For top jamb installations where the door frame header height is insufficient for direct mounting.



SNB1420
Aluminum sex nut & steel thru-bolt kit (4) for doors 1¾" (44.5 mm) thick.

SNB51420
Steel sex nut & thru-bolt kit (4) for doors 1¾" (44.5 mm) thick.



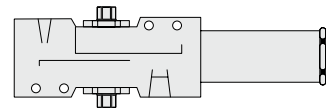

- Certifications**
- Conforms to ANSI/BHMA A156.4, Grade 1
 - cULus listed, 3hr fire-rating
 - ADA compliant, barrier free
 - 10 Year limited warranty
- Power Size**
- Adjustable size 1-6 (preset 3)
- See selection guide for details*
- Body Material**
- Precision cast iron body, painted finish
- Mechanism**
- Hydraulic rack and pinion operation
- Fluid**
- Non-gumming, non-freezing hydraulic fluid
 - Operating range of -30° to 49° C (-22° to 120° F)
- Adjustments**
- Sweep speed adjustment valve
 - Latching speed adjustment valve
 - Cushioning backcheck adjustment valve
- Cover**
- Full body plastic cover, painted finish
- Handing**
- Non-handed
- Opening**
- 120° maximum
 - 180° maximum with parallel arm

- Mounting**
- Tri-Pack: regular¹, top jamb¹, parallel arm²
 - Maximum reveal: 3" (76 mm)
 - Forearm extensions³ – available
 - Drop plates – available

(1) Arm allows 15% power adjustment

(2) May reduce spring power efficiency by 25%

(3) For reveal up to 5" (127 mm) or 9" (228 mm)

- Hardware**
- Wood screws & self-tapping machine screws
 - Sex nuts & thru-bolts

- Available Arms**
- Extra duty parallel arm
 - Friction hold open arm
 - Heavy duty cushion stop arm, hold open
 - Heavy duty cushion stop arm, no hold open
 - Heavy duty spring stop arm, no hold open

- Finish**
- AL—Aluminum, painted;
 - DU—Dark bronze, painted

Other finishes available by special order

441 BC	-	AL
MODEL		FINISH

SEE SELECTION GUIDE FOR DETAILS

SELECTION GUIDE

MODEL	POWER SIZE	WEIGHT CAPACITY ¹	MAX. DOOR WIDTH ²		BACKCHECK	DELAYED ACTION	FINISH	/CASE
			INTERIOR	EXTERIOR				
441 BC REGULAR ARM	Ⓢ						AL, DU	6
441 BCC CUSHION-STOP ARM, NO HOLD OPEN	Ⓢ	1-6	330 (150)	60 (1524)	●	—	AL	4
441 BCH CUSHION-STOP ARM, HOLD OPEN*	Ⓢ						AL	4

CAUTION: ANY DOOR CLOSER INSTALLED AND ADJUSTED BASED ON ADA REDUCED FORCE REQUIREMENTS MAY NOT RELIABLY CLOSE AND LATCH DOOR.
(1) WEIGHT CAPACITY IN POUNDS (KILOGRAMS) (2) MAXIMUM DOOR WIDTH IN INCHES (MILLIMETRES) (*) NOT FOR USE ON FIRE RATED DOORS

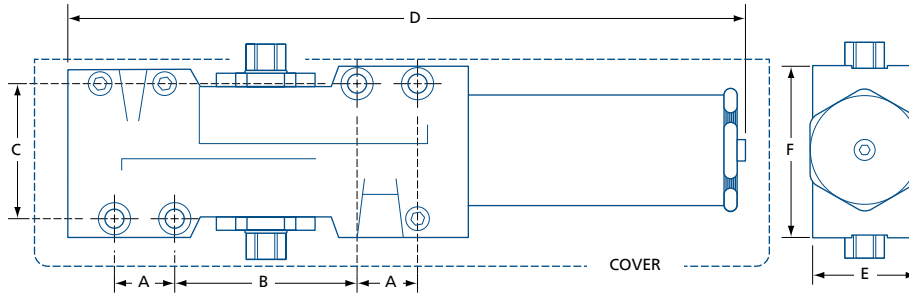

MODEL	A	B	C	D	E	F
441	1 (25)	3 (76)	2¼ (57)	11½ (287)	2 (51)	2¾ (70)
441 with cover	1 (25)	3 (76)	2¼ (57)	12¼ (311)	2¼ (57)	3½ (89)

IN (MM)

PARTS & ACCESSORIES



ARM441C
Heavy duty cushion stop arm, no hold open.
Included with 441BCC.



ARM441H
Heavy duty cushion stop arm, hold open.
Not for use on fire rated doors. *Included with 441BCH.*



ARM441E
Parallel arm for extra-duty applications.



ARM441HS
Heavy duty spring stop arm, hold open. Not for use on fire rated doors.



ARM441S
Heavy duty spring stop arm, no hold open.



ARM441F
Adjustable friction hold open arm, for standard, top jamb or parallel arm installation. Not for use on fire rated doors.



441LR
Long forearm link for reveal greater than 3" (76) up to 5" (127 mm).



441ELR
Extra long forearm link for reveals up to 5-9" (127-228 mm).



DP441-18
For regular arm installations where the door top rail height is insufficient for direct mounting.



DP441-18G
For top jamb installations where low ceiling clearance prevents direct mounting.



DP441-18PA
For parallel arm installations where the door top rail height is insufficient for direct mounting.



DP441-18TJ
For top jamb installations where the door frame header height is insufficient for direct mounting.

SNB1420
Aluminum sex nut & steel thru-bolt kit (4) for doors 1¾" (44.5 mm) thick.





- Certifications**
- Certified ANSI/BHMA A156.4, Grade 1
 - cULus listed, 3hr fire-rating
 - ADA compliant, barrier free
 - 10 Year limited warranty

- Power Size**
- Adjustable size 1-6 (preset 3)
- See selection guide for details*

- Body Material**
- Cast aluminum body, painted finish

- Mechanism**
- Hydraulic rack and pinion operation

- Fluid**
- Non-gumming, non-freezing hydraulic fluid
 - Operating range of -35° to 49°C (-31° to 120°F)

- Adjustments**
- Sweep speed adjustment valve
 - Latching speed adjustment valve
 - Cushioning backcheck adjustment valve
 - Delayed action adjustment valve – option

- Cover**
- Full body plastic cover, painted finish
 - Full body metal cover, plated finish (BP finish only) – option

- Handing**
- Non-handed

- Opening**
- 180° maximum

- Mounting**
- Tri-Pack: regular¹, top jamb¹, parallel arm²
 - Maximum reveal: 2¾" (70mm)
 - Drop plates – available

- (1) Arm shoe allows ±7.5% power adjustment
(2) May reduce spring power efficiency by 25%*

- Hardware**
- Wood screws & self-tapping machine screws
 - Sex nuts & thru-bolts

- Available Arms**
- Friction hold open arm
 - Heavy duty cushion stop arm, hold open
 - Heavy duty cushion stop arm, no hold open
 - Heavy duty spring stop arm, no hold open

- Finish**
- AL–Aluminum, painted; BP–Brass, plated; DU–Dark bronze, painted; MB–Matte black, painted

Other finishes available by special order

1901BC – AL
MODEL FINISH

SEE SELECTION GUIDE FOR DETAILS

SELECTION GUIDE

MODEL	POWER SIZE	WEIGHT CAPACITY ¹	MAX. DOOR WIDTH ²		BACKCHECK	DELAYED ACTION	FINISH	/CASE
			INTERIOR	EXTERIOR				
1901 BC REGULAR ARM	1-6	330 (150)	54 (1372)	48 (1219)	●	—	AL, BP, DU, MB	6
1901 BCDA REGULAR ARM								
1901 HC CUSHION-STOP ARM, HOLD OPEN*	1-6	330 (150)	54 (1372)	48 (1219)	●	—	AL	4
1901 NHC CUSHION-STOP ARM, NO HOLD OPEN								

CAUTION: ANY DOOR CLOSER INSTALLED AND ADJUSTED BASED ON ADA REDUCED FORCE REQUIREMENTS MAY NOT RELIABLY CLOSE AND LATCH DOOR.
 (1) WEIGHT CAPACITY IN POUNDS (KILOGRAMS) (2) MAXIMUM DOOR WIDTH IN INCHES (MILLIMETRES) (*) NOT FOR USE ON FIRE RATED DOORS

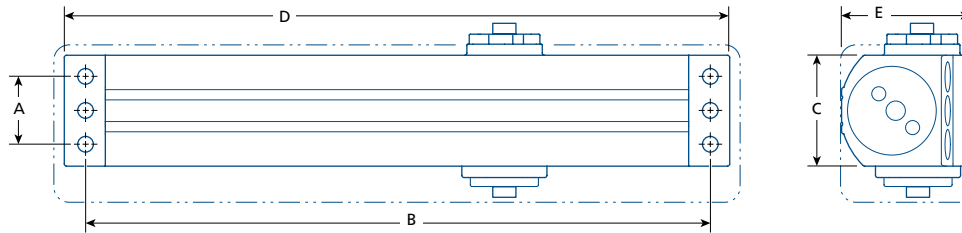

MODEL	A	B	C	D	E
1901	1 ¹ / ₈ (29)	11 ¹ / ₈ (283)	2 (51)	11 ⁷ / ₈ (302)	2 ³ / ₈ (61)
1901 with cover	1 ¹ / ₈ (29)	11 ¹ / ₈ (283)	3 (76)	12 ¹ / ₈ (308)	2 ¹ / ₂ (64)

IN (MM)

PARTS & ACCESSORIES



1901-CSA
Heavy-duty cushion stop arm, hold open.
Not for use on fire rated doors. *Included with 1901HC door closer.*



1901-CSANHO
Heavy-duty cushion stop arm, no hold open.
Included with 1901NHC door closer.



1901-SCSANHO
Heavy-duty cushion spring stop arm, no hold open.



1901-ARMF
Regular arm with adjustable friction hold open. Includes parallel arm bracket. Not for use on fire rated doors.



1901SANHO
Sliding arm, no hold open - for fire rated operation.

1901SAHO
Sliding arm, hold open - not for use on fire rated operation.



1901-DP
For regular arm installations where the door top rail height is insufficient for direct mounting.



1901-DPTJ
For top jamb installations where low ceiling clearance prevents direct mounting.



1901-DPTJN
Narrow plate for top jamb installations where the door frame header height is insufficient for direct mounting.



1901-DPPA
For parallel arm installations where the door top rail height is insufficient for direct mounting.



SNBS1420
Steel sex nut & thru-bolt kit (4) for doors 1³/₄" (44.5mm) thick.





- Certifications**
- Conforms to ANSI/BHMA A156.4, Grade 1
 - cULus listed, 3hr fire-rating
 - ADA compliant barrier free model – available
 - 10 Year limited warranty

- Power Size**
- Adjustable size 2-6 (preset 3)
 - Adjustable size 1-4 (preset 2), barrier free

See selection guide for details

- Body Material**
- Cast aluminum body, painted finish

- Mechanism**
- Hydraulic rack and pinion operation

- Fluid**
- Non-gumming, non-freezing hydraulic fluid
 - Operating range of -35° to 49°C (-31° to 120°F)

- Adjustments**
- Sweep speed adjustment valve
 - Latching speed adjustment valve
 - Cushioning backcheck adjustment valve
 - Delayed action adjustment valve – option

- Cover**
- Full body plastic cover, painted finish

- Handing**
- Non-handed

- Opening**
- 180° maximum

- Mounting**
- Tri-Pack: regular¹, top jamb¹, parallel arm²
 - Maximum reveal: 2¾" (70mm)
 - Drop plates – available

*(1) Arm shoe allows ±7.5% power adjustment
(2) May reduce spring power efficiency by 25%*

- Hardware**
- Wood screws & self-tapping machine screws
 - Sex nuts & thru-bolts – available

- Available Arms**
- Regular arm with adjustable hold open
 - Heavy duty cushion stop arm, hold open
 - Heavy duty cushion stop arm, no hold open
 - Sliding arm with optional hold open

- Finish**
- AL–Aluminum, painted; DU–Dark bronze, painted; MB–Matte black, painted

Other finishes available by special order

1900BF – AL
MODEL FINISH

SEE SELECTION GUIDE FOR DETAILS

SELECTION GUIDE

MODEL	POWER SIZE	WEIGHT CAPACITY ¹	MAX. DOOR WIDTH ²		BACKCHECK	DELAYED ACTION	FINISH	/CASE
			INTERIOR	EXTERIOR				
1900	2-6	330 (150)	54 (1372)	48 (1219)	•	—	AL, DU, MB	6
1900 BF 	1-4	265 (120)	48 (1219)	42 (1067)	•	•	AL, DU	6

CAUTION: ANY DOOR CLOSER INSTALLED AND ADJUSTED BASED ON ADA REDUCED FORCE REQUIREMENTS MAY NOT RELIABLY CLOSE AND LATCH DOOR.
 (1) WEIGHT CAPACITY IN POUNDS (KILOGRAMS) (2) MAXIMUM DOOR WIDTH IN INCHES (MILLIMETRES)

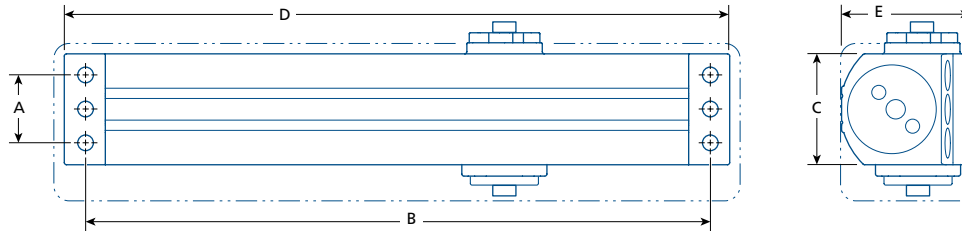

MODEL	A	B	C	D	E
1900	1 ¹ / ₈ (29)	11 ¹ / ₈ (283)	2 (51)	11 ⁷ / ₈ (302)	2 ³ / ₈ (61)
1900 with cover	1 ¹ / ₈ (29)	11 ¹ / ₈ (283)	3 (76)	12 ¹ / ₈ (308)	2 ¹ / ₂ (64)

IN (MM)

PARTS & ACCESSORIES



CSA1900
Heavy-duty cushion stop arm, hold open.
Not for use on fire rated doors.



DP1900
For parallel arm installations where the door top rail height is insufficient for direct mounting.



CSANHO1900
Heavy-duty cushion stop arm, no hold open.



735
Parallel arm bracket.



HOA1900
Regular arm with adjustable hold open and parallel arm bracket. Not for use on fire rated doors.



SNB1420
Aluminum sex nut & steel thru-bolt kit (4) for doors 1³/₄" (44.5 mm) thick.



SA1900
Sliding arm with optional hold open. Not for use on fire rated doors.





- Certifications**
- Certified ANSI/BHMA A156.4, Grade 1
 - cULus listed, 3hr fire-rating
 - ADA compliant, barrier free
 - 10 Year limited warranty

- Power Size**
- Adjustable size 1–5 (preset 3)

- Body Material**
- Cast aluminum body, painted finish

- Mechanism**
- Hydraulic rack and pinion operation

- Fluid**
- Non-gumming, non-freezing hydraulic fluid
 - Operating range of -30° to 49° C (-22° to 120° F)

- Adjustments**
- Sweep speed adjustment valve
 - Latching speed adjustment valve
 - Cushioning backcheck adjustment valve

- Cover**
- Low-profile, plastic cover with pinion cap, painted finish

- Handing**
- Non-handed

- Opening**
- 180° maximum

- Mounting**
- Tri-Pack: regular¹, top jamb¹, parallel arm²
 - Maximum reveal: 2¾" (70 mm)
 - Forearm extension³ – available
 - Drop plates – available

(1) Arm shoe allows ±7.5% power adjustment

(2) May reduce spring power efficiency by 25%

(3) For reveal up to 6¼" (159 mm)

- Hardware**
- Wood screws & self-tapping machine screws
 - Sex nuts & thru-bolts

- Available**
- Friction hold open arm

- Arms**
- Heavy duty cushion stop arm, hold open
 - Heavy duty cushion stop arm, no hold open
 - Heavy duty spring stop arm, no hold open

- Finish**
- AL–Aluminum, painted; DU–Dark bronze, painted; MB–Matte black, painted

Other finishes available by special order

1701 BC – AL

MODEL FINISH

SEE SELECTION GUIDE FOR DETAILS

SELECTION GUIDE

MODEL	POWER SIZE	WEIGHT CAPACITY ¹	MAX. DOOR WIDTH ²		BACKCHECK	DELAYED ACTION	FINISH	/CASE
			INTERIOR	EXTERIOR				
1701 BC	⑤ 1-5	265 (120)	48 (1219)	42 (1067)	●	—	AL, DU, MB	10

CAUTION: ANY DOOR CLOSER INSTALLED AND ADJUSTED BASED ON ADA REDUCED FORCE REQUIREMENTS MAY NOT RELIABLY CLOSE AND LATCH DOOR.
 (1) WEIGHT CAPACITY IN POUNDS (KILOGRAMS) (2) MAXIMUM DOOR WIDTH IN INCHES (MILLIMETRES)

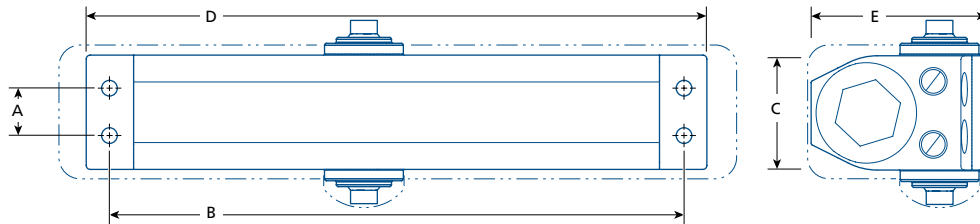

MODEL	A	B	C	D	E
1701	3/4 (19)	9 1/16 (230)	1 3/4 (44.5)	9 3/4 (248)	2 7/8 (73)
1701 with cover ¹	3/4 (19)	9 1/16 (230)	2 1/16 (53)	10 9/16 (269)	3 (76)

IN (MM) (1) ALL MODELS INCLUDE PINION CAP AND SLIM BODY COVER.

PARTS & ACCESSORIES



1901-CSA
Heavy-duty cushion stop arm, hold open. Not for use on fire rated doors.



1901-CSANHO
Heavy-duty cushion stop arm, no hold open.



1901-SCSANHO
Heavy-duty cushion spring stop arm, no hold open.



1901-ARMF
Regular arm with adjustable friction hold open. Includes parallel arm bracket. Not for use on fire rated doors.



1701-EXT
Arm extension rod for top jamb installation with reveal between 2 3/4–6 1/4" (70–159 mm).



1901SANHO
Sliding arm, no hold open - for fire rated operation.

1901SAHO
Sliding arm, hold open - not for use on fire rated operation.



1701-DP
Narrow plate for top jamb installations with low ceiling clearance or for regular arm installations where the door top rail height is insufficient for direct mounting.



1701-DPPA
For parallel arm installations where the door top rail height is insufficient for direct mounting.



SNBS1420
Steel sex nut & thru-bolt kit (4) for doors 1 3/4" (44.5 mm) thick.





- Certifications**
- Conforms to ANSI/BHMA A156.4, Grade 1
 - cULus listed, 3hr fire-rating
 - ADA compliant barrier free model –available
 - 5 Year limited warranty

- Power Size**
- Adjustable size 2-5 (preset 3)
 - Adjustable size 1-4 (preset 2), barrier free

See selection guide for details

- Body Material**
- Cast aluminum body, painted finish

- Mechanism**
- Hydraulic rack and pinion operation

- Fluid**
- Non-gumming, non-freezing hydraulic fluid
 - Operating range of -15° to 40°C (5° to 104°F)

- Adjustments**
- Sweep speed adjustment valve
 - Latching speed adjustment valve
 - Cushioning backcheck adjustment valve

- Cover**
- Low-profile, plastic cover with pinion cap, painted finish

- Handing**
- Non-handed
- Opening**
- 180° maximum

- Mounting**
- Tri-Pack: regular¹, top jamb¹, parallel arm²
 - Maximum reveal: 3" (76mm)
 - Drop plates – available

(1) Arm shoe allows ±7.5% power adjustment

(2) May reduce spring power efficiency by 25%

- Hardware**
- Wood screws & self-tapping machine screws
 - Sex nuts & thru-bolts

- Available Arms**
- Regular arm
 - Sliding arm with optional hold open

- Finish**
- AL–Aluminum, painted; BP–Brass, painted; DU–Dark bronze, painted

Other finishes available by special order

1700BF – AL
MODEL FINISH

SEE SELECTION GUIDE FOR DETAILS

SELECTION GUIDE

MODEL	POWER SIZE	WEIGHT CAPACITY ¹	MAX. DOOR WIDTH ²		BACKCHECK	DELAYED ACTION	FINISH	/CASE
			INTERIOR	EXTERIOR				
1700	2-5	265 (120)	48 (1219)	42 (1067)	●	—	AL, BP, DU	10
1700 BF 	1-4	190 (86)	42 (1067)	—	●	—	AL	10

CAUTION: ANY DOOR CLOSER INSTALLED AND ADJUSTED BASED ON ADA REDUCED FORCE REQUIREMENTS MAY NOT RELIABLY CLOSE AND LATCH DOOR.
 (1) WEIGHT CAPACITY IN POUNDS (KILOGRAMS) (2) MAXIMUM DOOR WIDTH IN INCHES (MILLIMETRES)

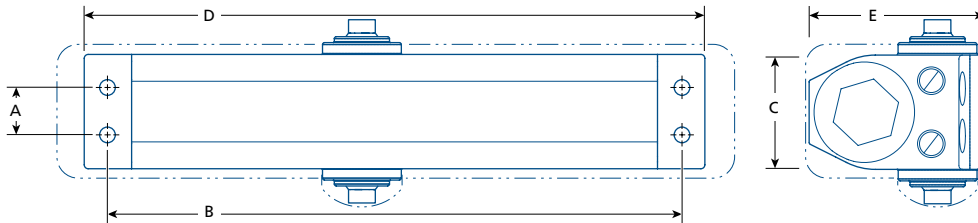

MODEL	A	B	C	D	E
1700	3/4 (19)	9 1/16 (230)	1 3/4 (44.5)	9 3/4 (248)	2 7/8 (73)
1700 with cover ¹	3/4 (19)	9 1/16 (230)	2 1/16 (53)	10 9/16 (269)	3 (76)

IN (MM) (1) ALL MODELS INCLUDE PINION CAP AND SLIM BODY COVER.

PARTS & ACCESSORIES



ARM754
Replacement regular arm.



SA1900
Sliding arm with optional hold open. Not for use on fire rated doors.



SNB1420
Aluminum sex nut & steel thru-bolt kit (4) for doors 1 3/4" (44.5 mm) thick.



DP754
For parallel arm installations where the door top rail height is insufficient for direct mounting.



DPN754
Narrow plate for top jamb installations with low ceiling clearance or for regular arm installations where the door top rail height is insufficient for direct mounting.



735
Parallel arm bracket.





- Certifications**
- cULus listed, 3hr fire-rating
 - ADA compliant, barrier free
 - 5 Year limited warranty

- Power Size**
- Adjustable size 1–5 (preset 3)
- See selection guide for details*

- Body Material**
- Cast aluminum body, painted finish

- Mechanism**
- Hydraulic rack and pinion operation

- Fluid**
- Non-gumming, non-freezing hydraulic fluid
 - Operating range of -39° to 49°C (-38° to 120°F)

- Adjustments**
- Sweep speed adjustment valve
 - Latching speed adjustment valve
 - Cushioning backcheck adjustment valve

- Cover**
- Plastic pinion cap, painted finish

- Handing**
- Non-handed

- Opening**
- 180° maximum

- Mounting**
- Tri-Pack: regular¹, top jamb¹, parallel arm²
 - Maximum reveal: 2½" (64.5 mm)

*(1) Arm shoe allows ±7.5% power adjustment
(2) May reduce spring power efficiency by 25%*

- Hardware**
- Wood screws & self-tapping machine screws
 - Sex-nut & thru-bolts

- Available Arms**
- Regular arm

- Finish**
- AL–Aluminum, painted; DU–Dark bronze, painted

Other finishes available by special order

1761 – AL
MODEL FINISH

SEE SELECTION GUIDE FOR DETAILS

SELECTION GUIDE

MODEL	POWER SIZE	WEIGHT CAPACITY ¹	MAX. DOOR WIDTH ²		BACKCHECK	DELAYED ACTION	FINISH	/CASE
			INTERIOR	EXTERIOR				
1761	 1-5	265 (120)	48 (1219)	42 (1067)	•	—	AL, DU	10

CAUTION: ANY DOOR CLOSER INSTALLED AND ADJUSTED BASED ON ADA REDUCED FORCE REQUIREMENTS MAY NOT RELIABLY CLOSE AND LATCH DOOR.
 (1) WEIGHT CAPACITY RANGE IN POUNDS (KILOGRAMS) (2) MAXIMUM DOOR WIDTH IN INCHES (MILLIMETRES)

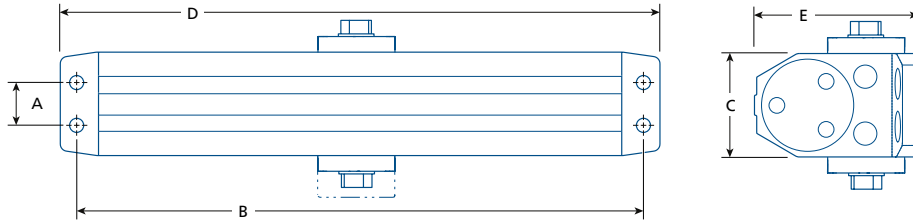

MODEL	A	B	C	D	E
1761	$\frac{3}{4}$ (19)	$9\frac{1}{16}$ (230)	$1\frac{13}{16}$ (46)	$9\frac{9}{16}$ (244.6)	$2\frac{13}{16}$ (71)

IN (MM)





- Certifications**
- Certified ANSI/BHMA A156.4, Grade 1
 - cULus listed, 3hr fire-rating
 - ADA compliant, barrier free
 - 10 Year limited warranty
- Power Size**
- Adjustable size 1-6 (preset 3)
- Body Material**
- Cast aluminum body, painted finish
- Mechanism**
- Hydraulic rack and pinion operation
- Fluid**
- Non-gumming, non-freezing hydraulic fluid
 - Operating range of -15° to 40°C (5° to 104°F)
- Adjustments**
- Sweep speed adjustment valve
 - Latching speed adjustment valve
 - Cushioning backcheck adjustment valve
 - Delayed action adjustment valve - option
- Cover**
- Narrow plastic cover with pinion cap, painted finish
 - Full body plastic cover, painted finish – available

- Handing**
- Non-handed
- Opening**
- 180° maximum
- Mounting**
- Tri-Pack: regular¹, top jamb¹, parallel arm²
 - Maximum reveal: 3" (76 mm)
 - Forearm extension³ – available
 - Drop plates – available
- (1) Arm shoe allows ±7.5% power adjustment
(2) May reduce spring power efficiency by 25%
(3) For reveal up to 4" (101.6 mm)*
- Hardware**
- Wood screws & self-tapping machine screws
 - Sex nuts & thru-bolts – available
- Available Arms**
- Regular arm, friction hold open
 - Heavy duty cushion stop arm, no hold open
 - Heavy duty cushion stop arm, hold open
 - Heavy duty spring cushion stop arm, no hold open
- Finish**
- AL–Aluminum, painted

Other finishes available by special order

851 BC - AL
MODEL FINISH

SEE SELECTION GUIDE FOR DETAILS

SELECTION GUIDE

MODEL	POWER SIZE	WEIGHT CAPACITY ¹	MAX. DOOR WIDTH ²		BACKCHECK	DELAYED ACTION	FINISH	/CASE
			INTERIOR	EXTERIOR				
851 BC	1-6	265	54	48	●	—	AL	6
851 BCDA	1-6	(120)	(1372)	(1219)	●	●	AL	6

CAUTION: ANY DOOR CLOSER INSTALLED AND ADJUSTED BASED ON ADA REDUCED FORCE REQUIREMENTS MAY NOT RELIABLY CLOSE AND LATCH DOOR.
 (1) WEIGHT CAPACITY IN POUNDS (KILOGRAMS) (2) MAXIMUM DOOR WIDTH IN INCHES (MILLIMETRES)

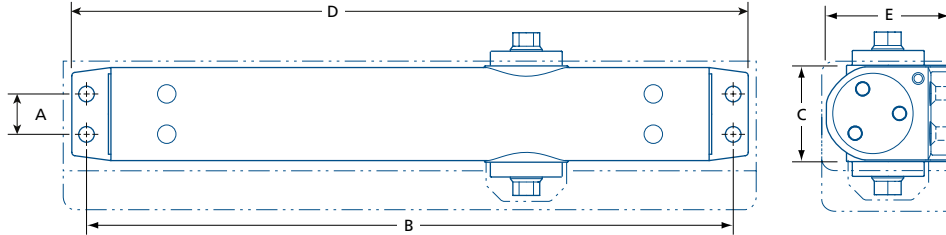

MODEL	A	B	C	D	E
851 WITH NARROW COVER ¹	3/4	11 15/16	1 7/8 (47)	12 3/4 (324)	2 (50.5)
851 WITH FULL BODY COVER ¹	(19)	(303)	3 (76)	13 (330)	2 1/16 (54.5)

IN (MM) (1) PIVOT CAP AND NARROW COVER INCLUDED; FULL BODY COVER SOLD SEPARATELY

PARTS & ACCESSORIES



CSA851
Heavy duty cushion stop arm, hold open. Not for use on fire rated doors.



CSANHO851
Heavy duty cushion stop arm, no hold open.



SCSANHO851
Heavy duty cushion spring stop arm, no hold open.



851-ARMF
Regular arm with adjustable friction hold open. Includes parallel arm bracket. Not for use on fire rated doors.



851-EXT
Long forearm link for reveal up to 4" (102 mm).



FULLCOVER851
Full body plastic cover.
LxWxD: 13 x 3 x 2 1/16" (330 x 76 x 52 mm)



851-DP
For regular installations where the door top rail height is insufficient for direct mounting.



851-DPTJ
For top jamb installations where the door frame header height is insufficient for direct mounting.



851-DPPA
For parallel arm installations where the door top rail height is insufficient for direct mounting.



SNB1420
Aluminum sex nut & steel thru-bolt kit (4) for doors 1 3/4" (44.5 mm) thick.





- Certifications**
- cULus listed, 3hr fire-rating
 - 5 Year limited warranty

- Power Size**
- Fixed power size 1, 2, 3, 4 or 5
- See selection guide for details*

- Body Material**
- Cast aluminum alloy, painted finish

- Mechanism**
- Hydraulic rack and pinion

- Fluid**
- Non-gumming, non-freezing hydraulic fluid
 - Operating range of -15° to 40°C (5° to 104°F)

- Adjustments**
- Sweep speed valve
 - Latching speed valve
 - Cushioning backcheck valve – option

- Cover**
- Plastic pinion cap, painted finish

- Handing**
- Non-handed

- Opening**
- 180° maximum

- Mounting**
- Tri-Pack: regular¹, top jamb¹, parallel arm²
 - Maximum reveal: 3" (76 mm)
 - Drop plates – available

(1) Arm shoe allows ±7.5% power adjustment

(2) May reduce spring power efficiency by 25%

- Hardware**
- Wood & machine screws
 - Sex nuts & thru-bolts – available

- Available Arms**
- Regular arm

- Finish**
- AL–Aluminum, painted; BP–Brass, painted; DU–Dark bronze, painted

Other finishes available by special order

754	AL
MODEL	FINISH

SEE SELECTION GUIDE FOR DETAILS

SELECTION GUIDE

MODEL	POWER SIZE	WEIGHT CAPACITY ¹	MAX. DOOR WIDTH ²		BACKCHECK	DELAYED ACTION	FINISH	/CASE
			INTERIOR	EXTERIOR				
751	1	33–80 (15–36)	32 (813)	—	—	—	AL, BP, DU	10
752	2	55–100 (25–45)	36 (914)	—	—	—	AL, BP, DU	10
753	3	90–145 (40–66)	44 (1118)	—	—	—	AL, BP, DU	10
783					•	—	AL	10
754	4	125–190 (57–86)	48 (1219)	36 (914)	—	—	AL, BP, DU	10
784					•	—	AL, DU	10
755	5	175–265 (80–120)	52 (1321)	44 (1118)	—	—	AL, BP, DU	10
785					•	—	AL, DU	10

CAUTION: ANY DOOR CLOSER INSTALLED AND ADJUSTED BASED ON ADA REDUCED FORCE REQUIREMENTS MAY NOT RELIABLY CLOSE AND LATCH DOOR.

(1) WEIGHT CAPACITY RANGE IN POUNDS (KILOGRAMS) (2) MAXIMUM DOOR WIDTH IN INCHES (MILLIMETRES)

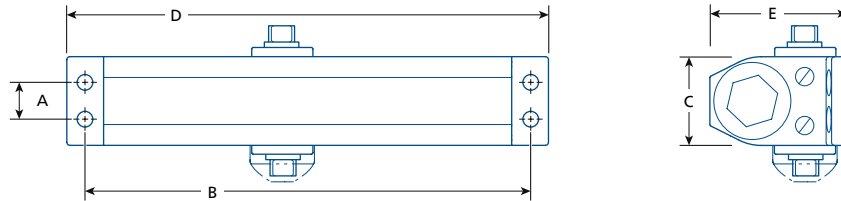

MODEL	A	B	C	D	E
751	¾ (19)	6½ (165)	1¹¹⁄₁₆ (43)	7⅞ (181)	2⁹⁄₁₆ (65)
752/753 (783)	¾ (19)	8³⁄₁₆ (208)	1¾ (45)	8⁷⁄₈ (225)	2⁷⁄₈ (73)
754/755 (784/785)	¾ (19)	9¹⁄₁₆ (230)	1¾ (45)	9¾ (248)	2⁷⁄₈ (73)

IN (MM)

PARTS & ACCESSORIES



ARM754

Arm for 752 to 785 door closers.



SNB1420

Aluminum sex nut & steel thru-bolt kit (4) for doors 1¾" (44.5 mm) thick.



715

Parallel arm bracket (sizes 1 & 2).



735

Parallel arm bracket (sizes 3, 4 and 5).



DP754

For parallel arm installations where the door top rail height is insufficient for direct mounting (models 754 / 755).



DPN754

Narrow plate for top jamb installations with low ceiling clearance or for regular arm installations where the door top rail height is insufficient for direct mounting.





- Certifications**
- cULus listed, 3hr fire-rating
 - 5 Year limited warranty

- Power Size**
- Fixed power size 2, 3, or 4
- See selection guide for details*

- Body Material**
- Cast aluminum alloy, painted finish

- Mechanism**
- Hydraulic rack and pinion operation

- Fluid**
- Non-gumming, non-freezing hydraulic fluid

- Adjustments**
- Sweep speed valve
 - Latching speed valve

- Cover**
- Plastic pinion cap, painted finish

- Handing**
- Non-handed

- Opening**
- 180° maximum

- Mounting**
- Tri-Pack: regular¹, top jamb¹, parallel arm²
 - Maximum reveal: 1½" (38mm)

*(1) Arm installation allows 15% power adjustment
(2) May reduce spring power efficiency by 25%*

- Hardware**
- Wood screws & self-tapping machine screws
 - Sex nuts & thru-bolts – available

- Available Arms**
- Forearm replacement

- Finish**
- AL–Aluminum, painted

Other finishes available by special order

302	AL
MODEL	FINISH

SEE SELECTION GUIDE FOR DETAILS

SELECTION GUIDE

MODEL	POWER SIZE	WEIGHT CAPACITY ¹	MAX. DOOR WIDTH ² INTERIOR	MAX. DOOR WIDTH ² EXTERIOR	BACKCHECK	DELAYED ACTION	FINISH	/CASE
302	2	55–100 (25–45)	36 (914)	—	—	—	AL	10
303	3	85–140 (38–63)	42 (1067)	—	—	—	AL	10
304	4	125–190 (57–86)	48 (1219)	42 (1067)	—	—	AL	10

CAUTION: ANY DOOR CLOSER INSTALLED AND ADJUSTED BASED ON ADA REDUCED FORCE REQUIREMENTS MAY NOT RELIABLY CLOSE AND LATCH DOOR.
(1) DOOR WEIGHT CAPACITY RANGE IN POUNDS (KILOGRAMS) (2) MAXIMUM DOOR WIDTH IN INCHES (MILLIMETRES)

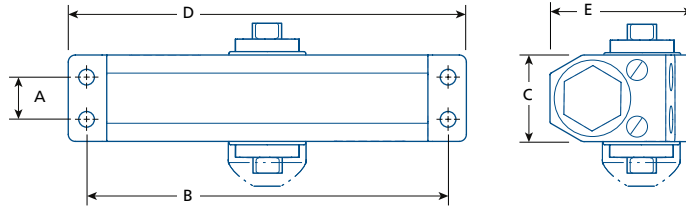

MODEL	A	B	C	D	E
302 / 303 / 304	$\frac{3}{4}$ (19)	$6\frac{3}{8}$ (162)	$1\frac{9}{16}$ (39)	$7\frac{1}{16}$ (180)	$2\frac{9}{16}$ (65)

IN (MM)

PARTS & ACCESSORIES



302-FARM
Replacement forearm for 302/303/304 door closer.



SNB1420
Aluminum sex nut & steel thru-bolt kit (4) for doors $1\frac{3}{4}$ " (44.5 mm) thick.



325
Parallel arm conversion kit.
Not recommended for 302 model.





- Certifications**
- cULus listed, 3hr fire-rating
 - 5 Year limited warranty

- Power Size**
- Fixed power size 3
- See selection guide for details*

- Body Material**
- Cast aluminum alloy, painted finish

- Mechanism**
- Hydraulic rack and pinion operation

- Fluid**
- Non-gumming, non-freezing hydraulic fluid
 - Operating range of -30° to 49°C (-22° to 120°F)

- Adjustments**
- Sweep speed valve
 - Latching speed valve

- Cover**
- Plastic pinion cap, painted finish

- Handing**
- Non-handed

- Opening**
- 180° maximum

- Mounting**
- Regular¹ or top jamb¹
 - Maximum reveal: 3" (76mm)

(1) Arm installation allows +12% power adjustment

- Hardware**
- Wood screws & self-tapping machine screws
 - Sex nuts & thru-bolts – available

- Finish** AL–Aluminum, painted
- Other finishes available by special order*

DC303	AL
MODEL	FINISH

SEE SELECTION GUIDE FOR DETAILS

SELECTION GUIDE

MODEL	POWER SIZE	WEIGHT CAPACITY ¹	MAX. DOOR WIDTH ² INTERIOR EXTERIOR	BACKCHECK	DELAYED ACTION	FINISH	/CASE
DC303	3	< 176 (< 80)	43 (1100)	—	—	AL	10

(1) DOOR WEIGHT CAPACITY RANGE IN POUNDS (KILOGRAMS) (2) MAXIMUM DOOR WIDTH IN INCHES (MILLIMETRES)

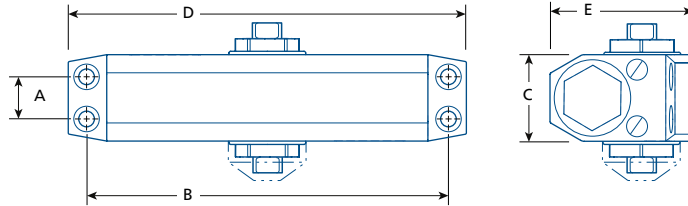

MODEL	A	B	C	D	E
DC303	$\frac{3}{4}$ (19)	$6\frac{3}{8}$ (162)	$1\frac{9}{16}$ (39)	7 (178)	$2\frac{7}{16}$ (62)

IN (MM)

PARTS & ACCESSORIES



SNB1420

Aluminum sex nuts & steel thru-bolt (4) for doors $1\frac{3}{4}$ " (44.5 mm) thick.



TC603 SERIES

DOOR CLOSER



- Certifications**
- cULus listed, 3hr fire-rating
 - 1 Year limited warranty

- Power Size**
- Fixed power size 3

- Body Material**
- Low profile
 - Cast aluminum alloy, painted finish

- Mechanism**
- Hydraulic rack and pinion operation

- Fluid**
- Non-gumming, non-freezing hydraulic fluid
 - Operating range of -30° to 49° C (-22° to 120°F)

- Adjustments**
- Sweep speed valve
 - Latching speed valve

- Cover**
- Aluminum cover plate
 - Plastic pinion cap, painted finish

- Handing**
- Non-handed

- Opening**
- 150° maximum

- Mounting**
- Regular¹ or top jamb¹
 - Parallel arm² bracket – available
 - Maximum reveal: 2½" (63.5 mm)

*(1) Arm installation allows 15% power adjustment
(2) May reduce spring power efficiency by 25%*

- Hardware**
- Wood screws
 - Sex nuts & thru-bolts – available

- Available Arms**
- Sliding arm with optional hold open

- Finish**
- AL–Aluminum; MB–Matte black

Other finishes available by special order

TC603	AL
MODEL	FINISH

SEE SELECTION GUIDE FOR DETAILS

SELECTION GUIDE

MODEL	POWER SIZE	WEIGHT CAPACITY ¹	MAX. DOOR WIDTH ² INTERIOR EXTERIOR	BACKCHECK	DELAYED ACTION	FINISH	/CASE
TC603	3	55–143 (25–65)	36 (914)	—	—	AL, MB	10

CAUTION: INSTALLATION POSITION WILL AFFECT THE FINAL CLOSING FORCE BETWEEN 1 AND 3 - SEE INSTALLATION INSTRUCTIONS FOR DETAILS.
(1) DOOR WEIGHT CAPACITY RANGE IN POUNDS (KILOGRAMS) (2) MAXIMUM DOOR WIDTH IN INCHES (MILLIMETRES)

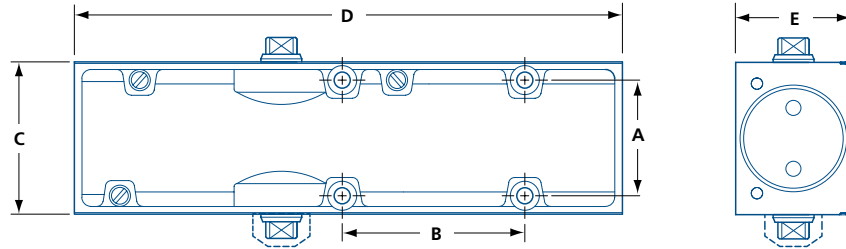

MODEL	A	B	C	D	E
TC603	1 1/2 (38)	2 3/8 (60)	2 (51)	7 1/8 (184)	1 9/16 (39)

IN (MM)

PARTS & ACCESSORIES



TC603-SA
Sliding arm with optional hold open. 120° opening. Not for use on fire rated doors. Available aluminum (AL) or matte black (MB).



TC603-PB
Parallel arm bracket for TC603.



SNB1420
Aluminum sex nuts & steel thru-bolt (4) for doors 1 3/4" (44.5 mm) thick.





- Certifications**
- cULus listed, 3hr fire-rating
 - 5 Year limited warranty

- Power Size**
- Fixed power size 3

- Body Material**
- Cast aluminum body, painted finish

- Mechanism**
- Hydraulic rack and pinion operation

- Fluid**
- Non-gumming, non-freezing hydraulic fluid
 - Operating range of -30° to 49° C (-22° to 120° F)

- Adjustments**
- Sweep speed adjustment valve
 - Latching speed adjustment valve

Cover —

- Handing**
- Non-handed

- Opening**
- 100° maximum (ehold open)
 - 120° maximum (no hold open)

- Door Type**
- For interior wood or hollow metal doors over 1¾" (44.5 mm) thick
 - Door must be hung using butt or pivot hinges

- Mounting**
- Installs in to top of door
 - Can be installed in door frame

- Hardware**
- Wood & machine screws

- Arm**
- Sliding arm , surface mounted, with adjustable hold open*

(*) Not to be used on fire rated doors

- Finish** AL—Aluminum, painted
Other finishes available by special order

DC3033	AL
MODEL	FINISH

SELECTION GUIDE

MODEL	POWER SIZE	WEIGHT CAPACITY ¹	MAX. DOOR WIDTH ²	BACKCHECK	DELAYED ACTION	FINISH	/CASE
DC3033	3	88-144 (40-65)	36 (914)	—	—	AL	10

(1) RECOMMENDED DOOR WEIGHT CAPACITY RANGE IN POUNDS (KILOGRAMS) (2) RECOMMENDED MAXIMUM DOOR WIDTH IN INCHES (MILLIMETRES)

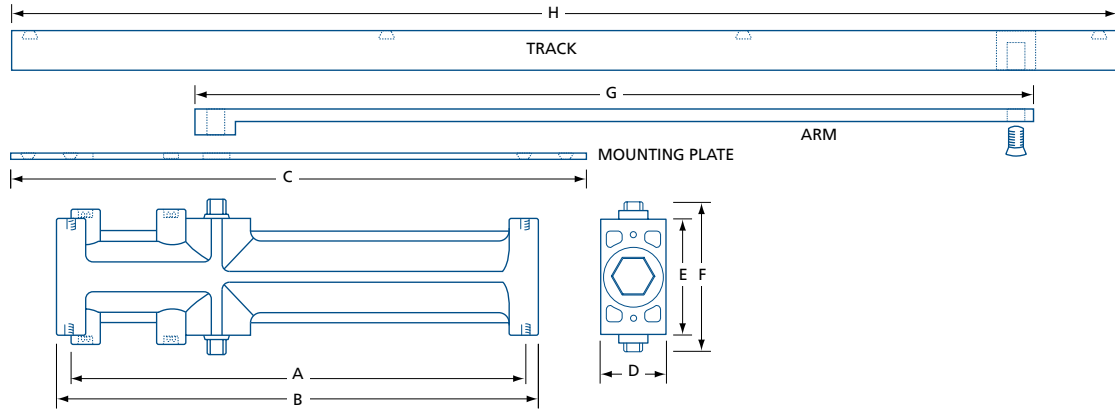

MODEL	A	B	C	D	E	F	G	H
DC3033	$8\frac{5}{8}$ (219)	$9\frac{1}{16}$ (230)	$10\frac{15}{16}$ (275)	$1\frac{1}{4}$ (32)	$2\frac{7}{32}$ (56)	$2\frac{7}{8}$ (72)	$14\frac{1}{2}$ (368)	$18\frac{1}{8}$ (460)

IN (MM)





- Certifications**
- EN1154 compliant for 500,000 cycles
 - 5 Year limited warranty

- Models**
- Light duty
 - Regular duty
 - Heavy duty

See selection guide for details

- Body Material**
- Compact cast steel body, painted finish

- Mechanism**
- Hydraulic, dual spring operation

- Fluid**
- Non-gumming, non-freezing hydraulic fluid
 - Operating range of -15° to 40°C (5° to 104°F)

- Adjustments**
- Sweep speed adjustment valve
 - Latching speed adjustment valve

Cover —

- Handing**
- Non-handed

- Opening**
- 90° maximum
 - 105° maximum – available
 - Mechanical hold open – available

See selection guide for details

- Door Types**
- Suitable for wood, metal or aluminum framed doors over 1¾" (44.5 mm) thick
 - Suitable for frame-less tempered glass doors up to ½" (13 mm) thick (patch fittings sold separately)

- Mounting**
- Universal single, double acting or centre-hung applications
 - Fits 1¾ x 4" (45 x 102 mm) header sections
- Interchangeable with JACKSON™ door closers*

- Hardware**
- Machine and wood screws
 - Mounting anchors

- Arms & Pivots**
- Side loading top arm
 - End loading top arm –option
 - Offset arm and channel –available
 - 18–20 mm channel depth pivot
 - 18–57 mm channel depth pivot –option

Finish —

30	RD	90	HO
MODEL	DUTY	OPENING	OPTION

HO-HOLD OPEN; NHO-NO HOLD OPEN
SEE SELECTION GUIDE FOR DETAILS

SELECTION GUIDE

MODEL	DESCRIPTION	MAXIMUM OPENING	OPTION ¹	WEIGHT CAPACITY ²	MAXIMUM DOOR SIZE ³	CLOSING FORCE Nm ⁴
30LD90	Light duty, bottom pivot, and side loading arm assembly.	90°	NHO	225 (100)	30x96 (732x2438)	13–18
30LD105		105°				
30RD90	Regular duty, bottom pivot, and side loading arm assembly. Available body-only (30B*)	90°	NHO, HO	225 (100)	42x96 (1067x2438)	18–26
30RD105		105°				
31RD90	Regular duty, 17 mm spindle, bottom pivot, and end loading arm assembly. Available body-only (31B*†)	90°	NHO, HO	225 (100)	42x96 (1067x2438)	18–26
31RD105		105°				
30HD90	Heavy duty, bottom pivot, and side loading arm assembly.	90°	NHO, HO	225 (100)	48x96 (1219x2438)	26–37
30HD105		105°				
31HD105	Heavy duty, 17 mm spindle, bottom pivot, and end loading arm assembly.	105°	NHO			

(1) NHO—NO HOLD OPEN; HO—HOLD OPEN (2) MAXIMUM DOOR WEIGHT IN POUNDS (KILOGRAMS). (3) MAXIMUM DOOR SIZE W X H IN INCHES (MILLIMETRES). (4) NOMINAL VALUES PROVIDED; MAY VARY WITH INSTALLATION. (*) SPECIAL ORDER. ARM, PIVOT, ANCHORS & MOUNTING HARDWARE NOT INCLUDED. (†) RECOMMENDED FOR FRAME-LESS TEMPERED GLASS DOOR APPLICATIONS.

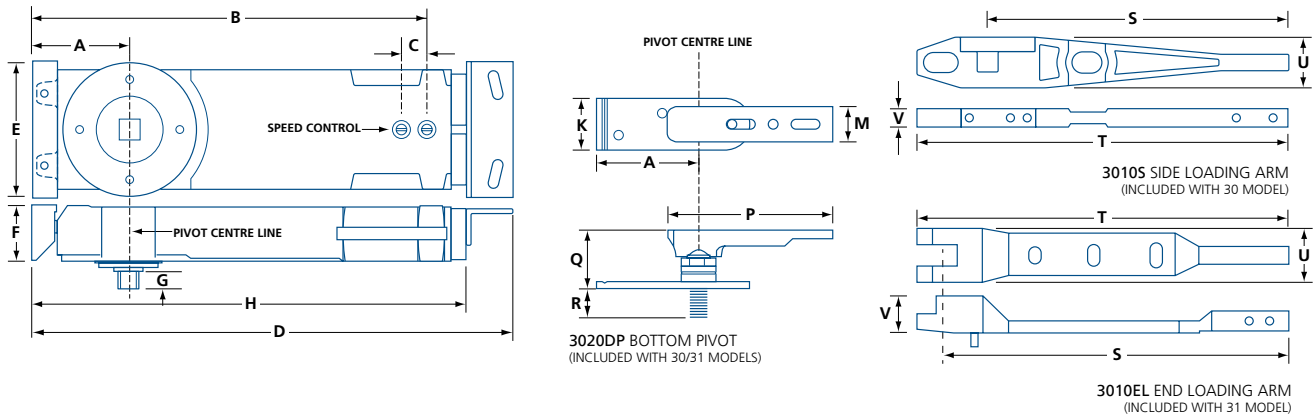

MODEL	A	B	C	D	E	F	G	H	K	M	P	Q	R	S	T	U	V
30	2¾ (70)	10¾ (273)	1¹⁄₁₆ (17.5)	12¾ (324)	3¹¹⁄₁₆ (94)	1½ (38)	½ (12.7)	11¾ (298)	1⅜ (35)	3¹⁄₃₂ (24)	4⁷⁄₁₆ (113)	1½–2¼ (38–57)	0–¾ (0–19)	8⅛ (206)	10 (254)	1⅜ (35)	17⁄₃₂ (13)
31							21⁄₃₂ (17)							8¹¹⁄₁₆ (220)	9⁷⁄₁₆ (240)		1 (25.4)

IN (MM)

PARTS & ACCESSORIES



3010S
Type “S” side loading arm assembly. Included with model 30.



3010OC
Offset arm and channel.



3010EL
Type “A” end loading arm for 1” (25.4mm) deep web. Included with model 31.



3010DP
Bottom pivot set (125 lbs / 56.8 kg max.), 18– 57 mm channel depth.



3010AMC
Anchor set. Included with 30 and 31 models.



3020DP
Bottom pivot set (125 lbs / 56.8 kg max.), 18– 20 mm channel depth. Included with 30 and 31 models.





Certifications • 5 Year limited warranty

- Models**
- Regular duty
 - Heavy duty

See selection guide for details

Body Material • Compact cast steel body, painted finish

Mechanism • Hydraulic, dual spring operation

- Fluid**
- Non-gumming, non-freezing hydraulic fluid
 - Operating range of -15° to 40°C (5° to 104°F)

- Adjustments**
- Sweep speed adjustment valve
 - Latching speed adjustment valve

Cover • Stainless steel cover plate, satin finish

Handing • Non-handed

- Opening**
- 90° maximum
 - 105° maximum – available
 - 130° maximum – available
 - Mechanical hold open – available

See selection guide for details

- Door Type**
- Suitable for wood, metal or aluminum framed doors over 1¾" (44.5 mm) thick
 - Suitable for frame-less tempered glass doors up to ½" (13 mm) thick (patch fittings sold separately)

- Mounting**
- Universal single, double acting or centre-hung applications
 - 1⅝" (41.3 mm) installation depth
 - Ideal for thin slab installations
- Interchangeable with JACKSON door closers*

- Hardware**
- Steel floor casing; 1⅝" (41.3 mm) installation depth
 - Required bolts, brackets and screws for casing installation

Finish C32D–Satin stainless steel
COVER PLATE ONLY
Other finishes available by special order

40B	RD	90	HO	–	RS
MODEL	DUTY	OPENING	OPTION		OPTION

HO-HOLD OPEN; NHO-NO HOLD OPEN; RS-REMOVABLE SPINDLE
SEE SELECTION GUIDE FOR DETAILS

SELECTION GUIDE

MODEL	DESCRIPTION	MAXIMUM OPENING	OPTION ¹	WEIGHT CAPACITY ²	MAXIMUM DOOR SIZE ³	CLOSING FORCE Nm ⁴
40 RD90	Regular duty, with bottom arm and top pivot assembly. Stainless steel cover included.	90°	HO	225 (100)	36x96 (914x2438)	18–26
40 RD105		105°				
40 RD130		130°				
40B RD90 -RS	Regular duty, body only, with removable 15 mm pivot with 3 mm extension.*	90°	HO	225 (100)	36x96 (914x2438)	18–26
40B RD130 -RS		130°	NHO			
40 HD90	Heavy duty, with bottom arm and top pivot assembly. Stainless steel cover included.	90°	HO	225 (100)	42x96 (1067x2438)	26–37
40 HD105		105°				
40 HD130		130°				

(1) NHO—NO HOLD OPEN; HO—HOLD OPEN (2) MAXIMUM DOOR WEIGHT IN POUNDS (KILOGRAMS). (3) MAXIMUM DOOR SIZE WXH IN INCHES (MILLIMETRES).

(4) NOMINAL VALUES PROVIDED; MAY VARY WITH INSTALLATION.

(*) RECOMMENDED FOR FRAME-LESS TEMPERED GLASS DOOR APPLICATIONS. CEMENT CASE, COVER & MOUNTING HARDWARE NOT INCLUDED. OTHER PIVOTS SOLD SEPARATELY.

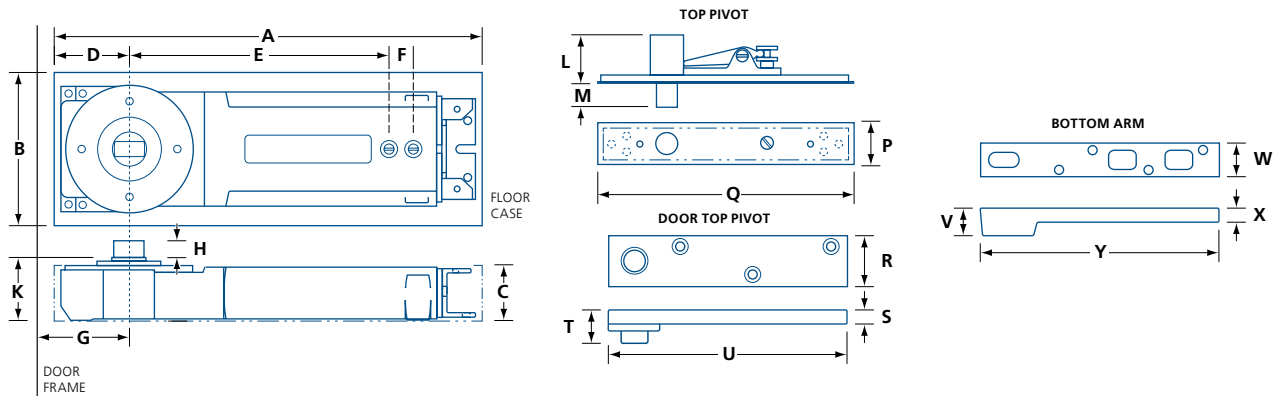

MODEL	A	B	C	D	E	F	G	H	K	L	M	P	Q	R	S	T	U	V	W	X	Y
40	12 ¹ / ₈ (308)	4 ¹ / ₄ (108)	1 ¹ / ₁₆ (40)	2 ¹ / ₈ (54)	7 ¹ / ₄ (184)	2 ³ / ₃₂ (18)	2 ³ / ₄ (70)	9 ¹ / ₁₆ (15)	1 ³¹ / ₃₂ (50)	1 ³ / ₈ (35)	2 ³ / ₃₂ (18.5)	1 ³ / ₁₆ (30)	6 ⁷ / ₈ (175)	1 ¹ / ₄ (32)	1 ⁵ / ₆₄ (6)	2 ⁵ / ₃₂ (20)	5 ²⁹ / ₃₂ (150)	1 ³ / ₁₆ (13)	1 ⁵ / ₁₆ (24)	7 ¹ / ₁₆ (11)	6 ⁵ / ₈ (168)

IN (MM)

PARTS & ACCESSORIES



40ESP-3
Removable 15 mm pivot, 3 mm extension.
Included with #40B.



40ESP-5
Removable 15 mm pivot, 5 mm extension.
Dimension K is 55 mm when installed.



40ESP-10
Removable 15 mm pivot, 10 mm extension.
Dimension K is 60 mm when installed.



40ESP-15
Removable 15 mm pivot, 15 mm extension.
Dimension K is 65 mm when installed.



40CP
Cover plate.
#40CPC3: Polished brass
#40CPC32D: Satin stainless steel



CONCEALED SPRING CLOSERS

SPECIALTY DOOR CLOSERS



CONCEALED SPRING CLOSER

PERKO



PERKO



ROUND CORNER MODEL
AVAILABLE BY SPECIAL ORDER

- cULus Listed for use on wood fire doors rated up to 30 minutes
- Concealed in door
- Suitable for interior doors up to 110 lbs (50 kg)
- Fits doors 1 $\frac{3}{8}$ –1 $\frac{3}{4}$ " (35–44.5 mm) thick
- Door opening depends on door thickness and hinge size - up to a maximum of 98°
- Not recommended for use on doors fitted with concealed hinges
- Adjustable spring power
- Non-handed
- Endurance tested for 500,000 cycles
- Available with round or square faceplates

Available in a variety of finishes. Please contact us to order.
Visit www.perkopower.com for product details.

PERKO	-	SCP
MODEL		FINISH

PLEASE CONTACT FOR SELECTION HELP



CONCEALED SPRING CLOSER – EXTENDED

PERKO-L, PERKO-LS



PERKO-L



PERKO-LS

- cULus Listed for use on wood fire doors rated up to 30 minutes
- Concealed in door
- Suitable for interior doors up to 110 lbs (50 kg) hung using standard hinges
- Fits doors 1 $\frac{3}{8}$ –1 $\frac{3}{4}$ " (35–44.5 mm) thick
- Door opening depends on door thickness and hinge size - up to a maximum of 180°
- Not recommended for use on doors fitted with concealed hinges
- Adjustable spring power
- Non-handed
- Endurance tested for 500,000 cycles
- Available with round or square faceplates

Available in a variety of finishes. Please contact us to order.
Visit www.perkopower.com for product details.

PERKO	-	LS	-	SCP
MODEL		TYPE		FINISH

PLEASE CONTACT FOR SELECTION HELP

CONCEALED SPRING CLOSERS

SPECIALTY DOOR CLOSERS



PERKOMATIC CONCEALED SPRING CLOSER

PERKOMATIC



- cULus Listed for use on wood fire doors rated up to 30 minutes
- Concealed in door
- Suitable for interior doors up to 165 lbs (75 kg)
- Fits doors 1¾" (44.5 mm) thick
- Door opening depends on installation - up to a maximum of 180°
- Not recommended for use on doors fitted with parliament (butterfly), concealed, projecting or rising butt hinges
- Adjustable latching speed
- Non-handed
- Endurance tested for 500,000 cycles

Available in a variety of finishes. Please contact us to order.
Visit www.perkopower.com for product details.

PERKOMATIC	-	C26D
MODEL		FINISH

PLEASE CONTACT FOR SELECTION HELP



POWERMATIC CONCEALED HYDRAULIC CLOSER

POWERMATIC



- cULus Listed for use on wood fire doors rated up to 45 minutes with intumescent mastic; up to 3 hours on metal doors
- Conforms to ANSI/BHMA 156.4 requirements
- Conforms to ADA maximum force requirements
- Concealed in door
- Suitable for latching and non-latching applications
- Suitable for doors up to 175 lbs (80 kg) and 37½" (950 mm) wide
- Fits doors 1¼–1¾" (32–44.5 mm) thick
- Door opening depends on installation - up to a maximum of 105°
- Not recommended for use on doors fitted with concealed hinges
- Adjustable latching and closing speed
- Non-handed
- Endurance tested for 500,000 cycles

Available in a variety of finishes. Please contact us to order.
Visit www.perkopower.com for product details.

POWERMATIC	-	C26D
MODEL		FINISH

PLEASE CONTACT FOR SELECTION HELP



PF100 SERIES

HYDRAULIC PATCH FITTING CLOSER



1
YEAR

-
- Certifications** • 1 Year limited warranty
- Panel Thickness** • $\frac{5}{16}$ – $\frac{1}{2}$ " (8–12.7 mm)
- Max. Door Width** • 39" (1000 mm)
- Max. Door Weight** • 220 lbs (100 kg)
- Max. Door Height** • For $\frac{5}{16}$ " (8 mm) glass: 84" (2134 mm)
• For $\frac{1}{2}$ " (12.7 mm) glass: 108" (2743 mm)
Recommended height. Please consult glass door manufacturer for more details.
- Body Material** • Machined aluminum
- Mechanism** • Hydraulic spring
- Fluid** • All weather hydraulic fluid
• Operating range of -20° to 49°C (-4° to 120°F)
- Adjustments** • Sweep speed adjustment
• Latching speed adjustment
• Door adjustments:
» Vertical / horizontal: $\pm \frac{1}{8}$ " (3 mm)
» CW /CCW: $\pm 4^\circ$
- Cover** • Stainless steel or aluminum* pinned cover
() When ordering aluminum (628) finish*
- Handing** • Non-handed
- Opening** • Double acting
• 150° maximum
• 90° hold open – option
- Mounting** • Floor surface mounted
- Hardware** • Screws and masonry anchors
- Finish** 628–Aluminum; 629–Polished stainless steel;
630–Satin stainless steel, 19–Matte black

PF100DC – 630

MODEL FINISH

SEE SELECTION GUIDE FOR DETAILS

SELECTION GUIDE

MODEL	WEIGHT CAPACITY ¹	MAX. DOOR WIDTH ²		MAX. DOOR HEIGHT ³	BACKCHECK	HOLD OPEN	FINISH
		INTERIOR	EXTERIOR				
PF100DC	220	39	—	84 or 108	—	—	628, 629
PF100DCHO	(100)	(1000)	—	(2134 or 2743)	—	●	630,19

(1) DOOR WEIGHT CAPACITY RANGE IN POUNDS (KILOGRAMS) (2) MAXIMUM DOOR WIDTH IN INCHES (MILLIMETRES)
 (3) FOR 5/16" (8MM) GLASS THICKNESS DO NOT EXCEED 84" (2134MM)

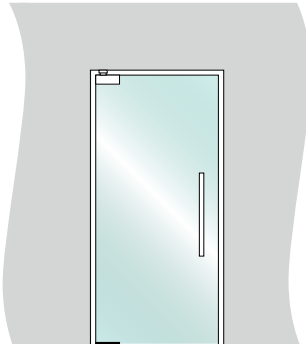

DOOR CLOSER
PF100DC / DCHO

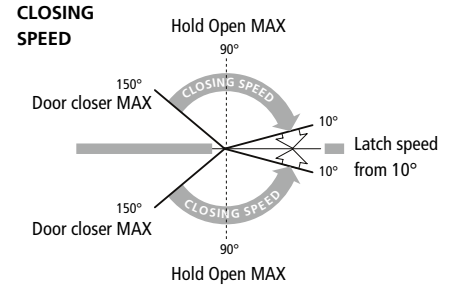
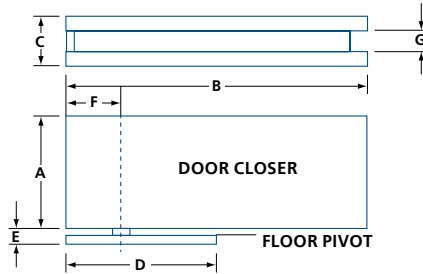

MODEL	A	B	C	D	E	F	G
PF100DC	2 ¹³ / ₁₆	7 ³ / ₁₆	1 ⁹ / ₁₆	4 ³ / ₈	1/2	2 ¹ / ₈	5 ¹ / ₁₆ to 1/2
PF100DCHO	(71.5)	(183)	(40)	(111)	(12.7)	(54)	(8 to 12.7)

IN (MM)

PARTS & ACCESSORIES



PF121
Top door patch fitting with extended covers. Available in matching finishes. See 04.400 for other glass patch fittings.



PF120TP1
Top pivot, surface mounted. Available in matte black (19) finish.



PF120TP2
Top walking pivot. Mortised, with adjustable pivot.



PF165CM
Ceiling mounted door stop. Cast stainless steel. Includes mounting screws and plastic anchors.



PF100DC-SD3 / PF100DCHO-SD3
Complete glass door kit. Includes PF100DC or PF100DCHO with PF121 and PF120TP1 in matching finishes.



Patch Fitting Door Locks
See 01.500 for a complete list of available patch fitting door locks.



Architectural Door Pulls
See 06.010 for a complete list of available architectural stainless steel door pulls.

- Including:
- Mitered door pulls
 - Ladder type door pulls
 - Offset door pulls



PF102 SERIES

HYDRAULIC PATCH FITTING CLOSER



1
YEAR

-
- Certifications** • 1 Year limited warranty
- Panel Thickness** • $\frac{5}{16}$ – $\frac{1}{2}$ " (8–12.7 mm)
- Max. Door Width** • 39" (1000 mm)
- Max. Door Weight** • 220 lbs (100 kg)
- Max. Door Height** • For $\frac{5}{16}$ " (8 mm) glass: 84" (2134 mm)
• For $\frac{1}{2}$ " (12.7 mm) glass: 108" (2743 mm)
Recommended height. Please consult glass door manufacturer for more details.
- Body Material** • Machined aluminum
- Mechanism** • Hydraulic spring
- Fluid** • All weather hydraulic fluid
• Operating range of -20° to 40°C (-4° to 104°F)
- Adjustments** • Sweep speed adjustment
• Latching speed adjustment
• Door adjustments:
» Vertical / horizontal: $\pm \frac{1}{32}$ " (1 mm)
» CW /CCW: $\pm 2^\circ$
- Cover** • Stainless steel snap-on cover
- Handing** • Non-handed
- Opening** • Double acting
• 170° Maximum
• 90° Hold open – option
- Mounting** • Floor surface mounted
- Hardware** • Screws and masonry anchors
- Finish** 630–Satin stainless steel; 19–Matte black*
() Special order–may require additional lead time and/or minimum order quantities*

PF102DC – 630

MODEL FINISH

SEE SELECTION GUIDE FOR DETAILS

SELECTION GUIDE

MODEL	WEIGHT CAPACITY ¹	MAX. DOOR WIDTH ²		MAX. DOOR HEIGHT ³	BACKCHECK	HOLD OPEN	FINISH
		INTERIOR	EXTERIOR				
PF102DC	220	39	—	84 or 108	—	—	630, 19*
PF102DCHO	(100)	(1000)	—	(2134 or 2743)	—	●	

(1) DOOR WEIGHT CAPACITY RANGE IN POUNDS (KILOGRAMS) (2) MAXIMUM DOOR WIDTH IN INCHES (MILLIMETRES)
 (3) FOR 5/16" (8MM) GLASS THICKNESS DO NOT EXCEED 84" (2134MM) (*)SPECIAL ORDER FINISH

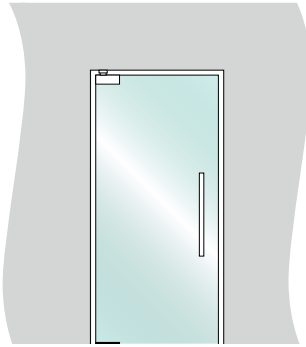

DOOR CLOSER
PF102DC / DCHO

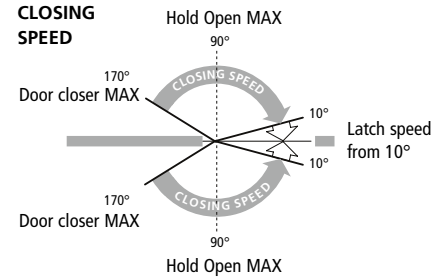
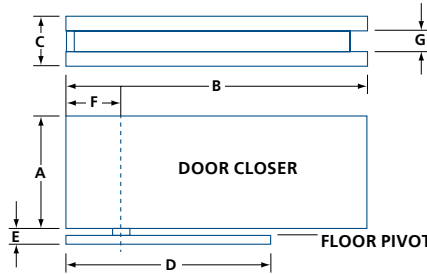

MODEL	A	B	C	D	E	F	G
PF102DC	2 ³ / ₄	7 ³ / ₁₆	1 ²¹ / ₃₂	4 ⁷ / ₈	1/2	2 ⁵ / ₁₆	1 ¹³ / ₃₂ to 1/2
PF102DCHO	(70)	(182)	(42)	(124)	(12.7)	(58)	(10 to 13)

IN (MM)

PARTS & ACCESSORIES



PF121
Top door patch fitting with extended covers. Available in matching finishes. See 04.400 for other glass patch fittings.



Patch Fitting Door Locks
See 01.500 for a complete list of available patch fitting door locks.



PF120TP1
Top pivot, surface mounted. Available in matte black (19) finish.



PF120TP2
Top walking pivot. Mortised, with adjustable pivot.



PF165CM
Ceiling mounted door stop. Cast stainless steel. Includes mounting screws and plastic anchors.



Architectural Door Pulls
See 06.010 for a complete list of available architectural stainless steel door pulls.

Including:
 – Mitered door pulls
 – Ladder type door pulls
 – Offset door pulls



AUXILIARY DOOR CLOSER

DOOR CHECK

DC500 SILENT DOOR CHECK

DC500



- For interior doors or walk-in freezer doors between 44–77 lbs (20–35 kg)
- 10 lbs (4.5 kg) closing force
- Non-handed
- Silent hydraulic mechanism
- Operating range of -10° to 40°C (14° to 104°F)
- Slows closing between 0° and 10°, preventing door slamming
- Surface mounted
- Includes standard hook for standard applications
- Other hooks available (sold separately)
 - #HH500: high hook for protruding door
 - #LH500: low hook for recessed door
- Mounting hardware included

DC500
MODEL

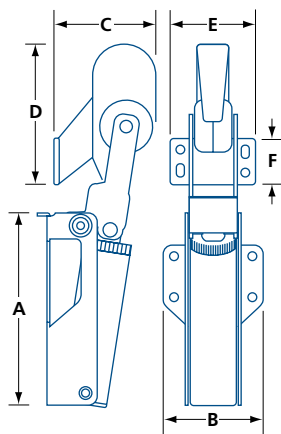

STANDARD HOOK FOR STANDARD DOORS

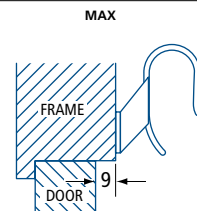
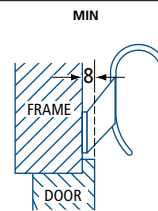
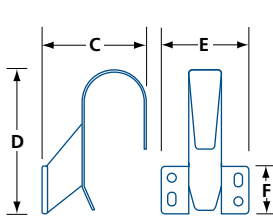

HIGH HOOK FOR PROTRUDING DOORS (HH500)

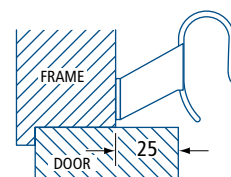
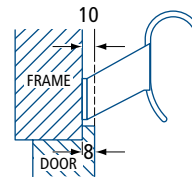
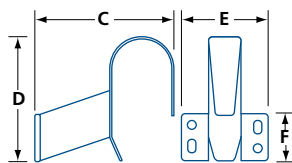

LOW HOOK FOR RECESSED DOORS (LH500)

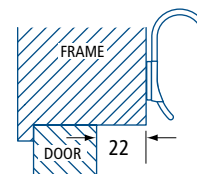
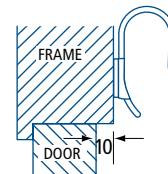
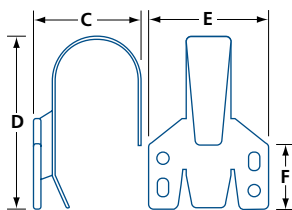

HH500
High Hook



LH500
Low Hook

MODEL	A	B	C	D	E	F
DC500	4 ³ / ₁₆ (106)	2 ⁷ / ₃₂ (56)	2 ⁷ / ₁₆ (62)	2 ³ / ₄ (70)	1 ⁷ / ₈ (48)	1 (25.4)
HH500*	—	—	3 ³ / ₁₆ (81)	2 ³ / ₄ (70)	1 ⁷ / ₈ (48)	1 (25.4)
LH500*	—	—	1 ¹ / ₁₆ (43.2)	2 ³ / ₄ (70)	1 ⁷ / ₈ (48)	1 (25.4)

IN (MM) (*)LOW AND HIGH HOOKS SOLD SEPARATELY

OVERHEAD STOPS & HOLDERS

CONCEALED MOUNT

ABH CONCEALED OVERHEAD STOP/HOLDER – HEAVY DUTY

ABH-1000



- UL Listed for use on wood fire doors rated up to 90 minutes and metal fire doors rated up to 3 hours (Stop Function Only)
- Concealed mount, heavy duty
- For Interior or exterior use on frequent traffic and heavy weight doors
- 1¾" (44.5 mm) minimum door thickness
- Stop, hold-open and friction functions available
- Single or Double acting doors
- Non-handed
- Standard installation from 85° to 110° of opening (5° increments)
- Shock absorbing spring provides 3° to 5° cushion before dead-stop

Available in a variety of finishes, models, options, and lengths. Please contact us to order. Visit www.abhmfg.com for product or warranty details (coverage may vary by region).

ABH-10	22	-32D
MODEL	TYPE	FINISH

PLEASE CONTACT FOR SELECTION HELP

ABH ADJUSTABLE CONCEALED OVERHEAD STOP/HOLDER – HEAVY DUTY

ABH-1000A



- UL Listed for use on wood fire doors rated up to 90 minutes and metal fire doors rated up to 3 hours (Stop Function Only)
- Concealed mount, heavy duty
- For Interior or exterior use on frequent traffic and heavy weight doors
- 1¾" (44.5 mm) minimum door thickness
- Stop, hold-open and friction functions available
- Single acting doors only
- Non-handed
- Degree of opening is field-adjustable after installation from 85° to 110° (5° increments)
- Shock absorbing spring provides 3° to 5° cushion before dead-stop

Available in a variety of finishes, models, options, and lengths. Please contact us to order. Visit www.abhmfg.com for product or warranty details (coverage may vary by region).

ABH-10	12	A	-32D
MODEL	TYPE		FINISH

PLEASE CONTACT FOR SELECTION HELP

OVERHEAD STOPS AND HOLDERS

CONCEALED MOUNT

ABH CONCEALED OVERHEAD STOP/HOLDER - SLIM LINE

ABH-1000SL



- UL Listed for use on wood fire doors rated up to 90 minutes and metal fire doors rated up to 3 hours (Stop Function Only)
- Concealed mount, heavy duty
- Slim line channel designed for aluminum store front doors
- For interior or exterior use on frequent traffic and heavy weight doors
- 1 3/4" (44.5 mm) minimum door thickness
- Stop and hold-open functions available
- Single or Double acting doors
- Non-handed
- Standard installation from 85° to 110° of opening (5° increments)
- Shock absorbing spring provides 3° to 5° cushion before dead-stop

Available in a variety of finishes, models, options, and lengths. Please contact us to order. Visit www.abhmfg.com for product or warranty details (coverage may vary by region).

ABH-10	12	SL	-32D
MODEL	TYPE	FINISH	

PLEASE CONTACT FOR SELECTION HELP

ABH CONCEALED OVERHEAD STOP/HOLDER - MEDIUM DUTY

ABH-4000



- UL Listed for use on wood fire doors rated up to 90 minutes and metal fire doors rated up to 3 hours (Stop Function Only)
- Concealed mount, medium duty
- For interior or exterior use on moderate traffic and medium weight doors
- 1 3/8" (35 mm) minimum door thickness
- Stop, hold-open and friction functions available
- Single or Double acting doors
- Non-handed
- Standard installation from 85° to 110° of opening (5° increments)
- Shock absorbing spring provides 3° to 5° cushion before dead-stop

Available in a variety of finishes, models, options, and lengths. Please contact us to order. Visit www.abhmfg.com for product or warranty details (coverage may vary by region).

ABH-40	24	-32D
MODEL	TYPE	FINISH

PLEASE CONTACT FOR SELECTION HELP



OVERHEAD STOPS & HOLDERS

SURFACE MOUNT

ABH OVERHEAD STOP/HOLDER – HEAVY DUTY

ABH-9000



- UL Listed for use on wood fire doors rated up to 90 minutes and metal fire doors rated up to 3 hours (Stop Function Only)
- Surface mount, heavy duty
- For Interior or exterior use on frequent traffic and heavy weight doors
- Standard fasteners supplied with sex bolts for 1¾–2¼" (44.5–57 mm) thick door (contact for other door thickness)
- Stop, hold-open and friction functions available
- Single acting doors only
- Non-handed
- Standard installation from 85° to 110° of opening (5° increments)
- Shock absorbing spring provides 3° to 5° cushion before dead-stop

Available in a variety of finishes, models, options, and lengths. Please contact us to order. Visit www.abhmfg.com for product or warranty details (coverage may vary by region).

ABH-90	22	-32D
MODEL	TYPE	FINISH

PLEASE CONTACT FOR SELECTION HELP

ABH OVERHEAD STOP/HOLDER – MEDIUM DUTY

ABH-4400



- UL Listed for use on wood fire doors rated up to 90 minutes and metal fire doors rated up to 3 hours (Stop Function Only)
- Surface mount, medium duty
- For Interior or exterior use on frequent traffic and heavy weight doors
- Standard fasteners supplied with sex bolts for 1¾–1⅞" (44.5–47.6 mm) thick door (contact for other door thickness)
- Stop, hold-open and friction functions available
- Single acting doors only
- Non-handed
- Standard installation from 85° to 110° of opening (5° increments)
- Shock absorbing spring provides 3° to 5° cushion before dead-stop

Available in a variety of finishes, models, options, and lengths. Please contact us to order. Visit www.abhmfg.com for product or warranty details (coverage may vary by region).

ABH-44	32	-32D
MODEL	TYPE	FINISH

PLEASE CONTACT FOR SELECTION HELP

OVERHEAD STOPS AND HOLDERS

SURFACE MOUNT

ABH ADJUSTABLE OVERHEAD STOP/HOLDER - MEDIUM DUTY

ABH-3300A



- UL Listed for use on wood fire doors rated up to 90 minutes and metal fire doors rated up to 3 hours (Stop Function Only)
- Surface mount, medium duty
- For Interior or exterior use on moderate traffic and medium weight doors
- Standard fasteners supplied with sex bolts for 1 $\frac{3}{4}$ –1 $\frac{7}{8}$ " (44.5–47.6mm) thick door (contact for other door thickness)
- Stop, hold-open and friction functions available
- Single acting doors only
- Non-handed
- Degree of opening is field adjustable from 85° to 110° (5° increments)
- Shock absorbing spring provides 3° to 5° cushion before dead-stop

Available in a variety of finishes, models, options, and lengths. Please contact us to order. Visit www.abhmfg.com for product or warranty details (coverage may vary by region).

ABH-33	23	A	-32D
MODEL	TYPE	FINISH	

PLEASE CONTACT FOR SELECTION HELP



DOOR COORDINATORS

SURFACE MOUNT

DOOR COORDINATOR – SURFACE MOUNTED

DCM, DCFB, DCMB



- UL listed fire door coordinator
- Use on paired doors (with astragal) to allow inactive door to close before active door
- Non-handed
- Surface mounted
- Aluminum extrusion with steel components
- Active door holding lever with adjustable tension
- Mounting hardware included: machine screws
- Anodized aluminum finish (28)
- Filler bars – available
- Mounting brackets for other components – available

DCSM	42	28
MODEL	SIZE	FINISH

SIZE	LENGTH	USAGE
32	32 (813)	For openings 34–52" (864–1320mm) or a pair of 24" (610mm) doors
42	42 (1067)	For openings 52–72" (1320–1829mm) or a pair of 30" (762mm) doors
52	52 (1320)	For openings 62–92" (1575–2337mm) or a pair of 36" (914mm) doors
60	60 (1524)	For openings 70–108" (1778–2743mm) or a pair of 42" (1067mm) doors

IN (MM)

MOUNTING BRACKETS



DCMB4250

- Allows other components to be installed over door coordinator
- Use with door frames with a door stop height of $\frac{5}{8}$ " (16mm) and a minimum door stop width of $2\frac{1}{2}$ " (64mm)
- Sold individually

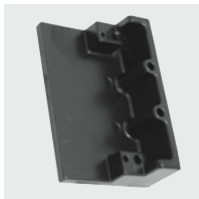

DCMB4750

- Allows other components to be installed over door coordinator
- Use with door frames with a door stop height of $\frac{5}{8}$ " (16mm) and a door stop width between $\frac{7}{8}$ – $2\frac{1}{4}$ " (22–57mm)
- Sold individually

FILLER BARS



DCFB

- DCSM coordinators do not always cover entire length of door stop. Filler bars are used maintain a clean aesthetic look.
- Aluminum extrusion, anodized finish (28)

ITEM	DIMENSIONS*
DCFB18-28	18 x $1\frac{5}{8}$ x $\frac{5}{8}$ (457 x 41 x 16)
DCFB32-28	32 x $1\frac{5}{8}$ x $\frac{5}{8}$ (813 x 41 x 16)
DCFB42-28	42 x $1\frac{5}{8}$ x $\frac{5}{8}$ (1067 x 41 x 16)

IN (MM) (*) LENGTH X WIDTH X HEIGHT

DOOR COORDINATORS

SURFACE MOUNT

GRAVITY DOOR COORDINATOR

DCG7, DCG9



- UL listed for fire doors, conforms to ANSI/BHMA 156.3 type 21
- For use on paired doors with astragal up to 4" (102 mm) to allow inactive door to close before active door
- Non-handed
- Surface mounted
- Solid brass, satin chrome finish
- Nylon and rubber rollers and strike plate provide quiet and efficient operation and help protect the doors from damage
- Mounting hardware included: machine screws

DCG9	-26D
MODEL	FINISH

MODEL	USAGE
-------	-------

DCG7	Use with paired doors with an active door size (with astragal) $\leq 48"$ (1290 mm) wide OR paired doors with an inactive door (with astragal) $\leq 40"$ (1016 mm) wide OR paired doors both with astragals $\leq 34"$ (864 mm) wide
------	---

DCG9	Use with paired doors with active door size (with astragal) $> 48"$ (1290 mm) wide OR paired doors with inactive door with astragal $> 40"$ (1016 mm) wide OR paired doors both with astragals $> 34"$ (864 mm) wide
------	--



DOOR COORDINATORS

DOOR MULLION

REMOVABLE DOOR MULLION

M418NF, M424FR



TOP
BRACKET



M418NF



BOTTOM
BRACKET



- Removable steel door mullion for use on standard or fire rated pairs of doors
- Provides a solid and secure center point for latching double doors
- Requires wide stile doors with a minimum width of 3¼" (82.5 mm)
- 2 x 3" (50.8 x 76 mm) steel tube, ⅛" (3mm) gauge for heavy duty use
- Can accommodate door frames up to 96" (2438 mm) high
- Lockable or removable
- Accepts standard rim cylinder and includes cylinder mounting hardware, rim cylinder not included, see rim cylinder on page 05.410
- Cast steel top and bottom brackets included
- Painted aluminum finish
- Mounting hardware included: machine screws and floor anchors
- #M418NF for standard paired doors up to 96" (2438 mm) high
- #M424FR UL Listed for fire rated paired doors up to 96" (2438 mm) high and includes longer floor anchors
- #M418BK Top and bottom brackets for M418NF
- #M424BK Top and bottom brackets for M424FR

M418NF
MODEL

ELECTROMAGNETIC DOOR HOLDERS

WALL MOUNT

ABH ELECTROMAGNETIC DOOR HOLDER – WALL MOUNT, LOW PROFILE

ABH-2400



- cULus listed for smoke barrier or labelled fire doors
- 1 $\frac{7}{8}$ " (48 mm) total projection from wall to face of door;
2 $\frac{7}{8}$ " (73 mm) if using included 1" (25.4 mm) armature extension
- Tri-voltage units for easy stocking and installation (12V DC, 24V AC/DC, or 120V AC)
- Includes 1" (25.4 mm) armature extension
- 35 lb. (16 kg) holding force
- All metal components – No plastic parts
- Outlet box required (not provided)
- Armature features a pivot point which each has 360° mobility to help door alignment and reduce installation time
- Positive release button alleviates residual magnetism
- Satin aluminum finish – other finishes available
- Various armature extension rod lengths available

Available in a variety of finishes, models, and options. Please contact us to order.
Visit www.abhmfg.com for product or warranty details (coverage may vary by region).

ABH-2400	-28
MODEL	FINISH

PLEASE CONTACT FOR SELECTION HELP

ABH ELECTROMAGNETIC DOOR HOLDER – SURFACE WALL MOUNT

ABH-2510



- cULus listed for smoke barrier or labelled fire doors
- 4 $\frac{1}{2}$ " (114 mm) total projection from wall to face of door;
5 $\frac{1}{2}$ " (127 mm) if using included 1" (25.4 mm) armature extension
- 24V AC/DC magnetic coil
- Includes 1" (25.4 mm) armature extension
- 300 lb. (136 kg) holding force
- All metal components – No plastic parts
- Outlet box required (not included)
- Armature features pivot points with 360° mobility to help door alignment and reduce installation time
- Positive release button alleviates residual magnetism
- Satin aluminum finish – other finishes available
- Various armature extension rod lengths available

Available in a variety of finishes, models, and options. Please contact us to order.
Visit www.abhmfg.com for product or warranty details (coverage may vary by region).

ABH-2510	-28
MODEL	FINISH

PLEASE CONTACT FOR SELECTION HELP

ELECTROMAGNETIC DOOR HOLDERS

FLOOR MOUNT

ABH ELECTROMAGNETIC DOOR HOLDER – FLOOR MOUNT, SINGLE

ABH-2600



- cULus listed for smoke barrier or labelled fire doors
- Tri-voltage units for easy stocking and installation (12V DC, 24V AC/DC, or 120V AC)
- Includes 1" (25.4 mm) armature extension
- 35 lb. (16 kg) holding force
- All metal components – No plastic parts
- Outlet box required (not included)
- Armature features pivot point with 360° mobility to help door alignment and reduce installation time
- Positive release button alleviates residual magnetism
- Satin aluminum finish – other finishes available
- Various armature extension rod lengths available

OFFICIAL DISTRIBUTOR Available in a variety of finishes and options. Please contact us to order. Visit www.abhmfg.com for product or warranty details (coverage may vary by region).

ABH-2600	-28
MODEL	FINISH

PLEASE CONTACT FOR SELECTION HELP

ABH ELECTROMAGNETIC DOOR HOLDER – FLOOR MOUNT, DOUBLE

ABH-2700



- cULus listed for smoke barrier or labelled fire doors
- Tri-voltage units for easy stocking and installation (12V DC, 24V AC/DC, or 120V AC)
- 24V AC/DC magnetic coil
- Includes 1" (25.4 mm) armature extension
- 35 lb. (16 kg) holding force
- All metal components – No plastic parts
- Outlet box required (not included)
- Armature features two pivot points with 360° mobility to help door alignment and reduce installation time
- Positive release button alleviates residual magnetism
- Satin aluminum finish – other finishes available
- Various armature extension rod lengths available

OFFICIAL DISTRIBUTOR Available in a variety of finishes and options. Please contact us to order. Visit www.abhmfg.com for product or warranty details (coverage may vary by region).

ABH-2700	-28
MODEL	FINISH

PLEASE CONTACT FOR SELECTION HELP





COMMERCIAL & RESIDENTIAL HINGES TABLE OF CONTENTS

Door Handing guide	ii
Finish Guide.....	ii
Abbreviation Guide.....	iii
COMMERCIAL HINGES	
DOREX BB1079, Full Mortise, Ball Bearing.....	04.016
DOREX CB1079, Full Mortise, Concealed Ball Bearing	04.018
DOREX PRO 1168, Full Mortise, Heavy Duty Ball Bearing	04.020
DOREX 1198, Full Mortise, Heavy Duty Ball Bearing	04.021
DOREX BB1068, Full Mortise, Heavy Duty Ball Bearing	04.022
DOREX 143, Full Mortise, Plain Bearing	04.031
DOREX BB1073, Half Surface, Ball Bearing	04.041
DOREX BB1077, Half Mortise, Ball Bearing.....	04.046
DOREX BB1048, Swing Clear, Ball Bearing	04.051
DOREX 1265, Reinforcement Hinge	04.060
Reinforcement & Filler Plates.....	04.065
DOREX 3310, Single Acting Spring Hinge.....	04.070
1310, Single Acting Spring Hinge.....	04.071
Commercial Spring Hinges.....	04.075
DOREX 1020, Universal Replacement Hinge.....	04.080
RESIDENTIAL HINGES	
Ball Bearing.....	04.100
Plain Bearing.....	04.101
Steel Entry	04.102
Decorative	04.103
Spring Hinge.....	04.103
Door Springs.....	04.104
CONTINUOUS GEARED HINGES	
ABH Continuous Geared Hinges BHMA	04.200
DOREX CGH Continuous Geared Hinges.....	04.210
PIVOTS	
Offset	04.300
Center Hung.....	04.311
Intermediate	04.312
Spring & Gravity Pivots.....	04.320
PATCH FITTINGS	
Glass Doors & Panels.....	04.400
ASSORTED	
Strap, Tee and Back Flap Hinges.....	04.500
Miscellaneous Hinges.....	04.501
Continuous (Piano) Hinges.....	04.502
SPECIALTY	
Invisible Hinges	04.600
Power Transfers	04.610

R20206410



DOOR HANDING GUIDE

LEFT HAND (LH)

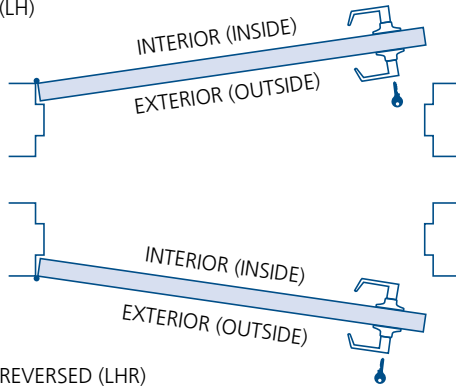

LEFT HAND REVERSED (LHR)

RIGHT HAND (RH)

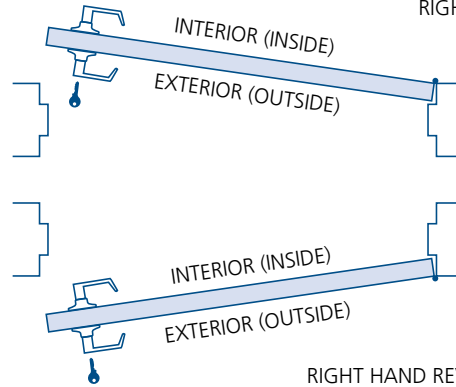

RIGHT HAND REVERSED (RHR)

FINISH GUIDE

PRIME COATED	BLACK JAPANED / LACQ.	MATTE BLACK LACQUER	ZINC PLATED	YELLOW ZINC PLATED
CODE CP	C1B, KJ	C1D	C2G, ZP	C2GY, YZ
BHMA* 600	601	693	603	
POLISHED BRASS	MIRROR POLISHED BRASS	SATIN BRASS	ANTIQU BRASS	ANTIQU BRONZE
BP, PB, C3, 3	C3M, 3M	C4, 4, SDB	AB, C5, 5	C11P, 11P
BHMA* 605, 632		606, 633	609, 638	617, 644
SATIN NICKEL	ANTIQU NICKEL	MATTE BLACK	DARK BRONZE / DURANODIC	POLISHED CHROME
SDN, SN, C15, 15	C15A, 15A	C19, 19	BLR, DU, C20D, 20D, C20	C26, 26
BHMA* 619, 646	620, 647	622, 631	650, 690, 695, 710	625, 651
SATIN CHROME	POLISHED STAINLESS STEEL	SATIN STAINLESS STEEL	ALUMINUM	PLAIN STEEL, NO FINISH
SC, C26D, 26D	C32, 32	SS, C32D, 32D	AL, C28, 28	PS
BHMA* 262, 652	629	630	628, 689	

ALL FINISHES IMAGES ABOVE ARE PHOTOGRAPHIC OR COLOUR APPROXIMATIONS, DELIVERED PRODUCT MAY VARY IN COMPARISON OR BETWEEN ORDERS/LOTS.

OTHER FINISHES AVAILABLE—PLEASE CONTACT.





(*) EQUIVALENT; CODES DIFFER DEPENDING ON BASE MATERIAL AND/OR FINISH PROCESS.

ABBREVIATION GUIDE

GENERAL

DIA, \varnothing	Diameter
KG	Kilograms
LBS	Pounds
LH	Left hand
LHR	Left hand reversed
MAX	Maximum
MIN	Minimum
N/A, —	Not applicable / Not available
QTY	Quantity (usually followed by notes)
RH	Right hand
RHR	Right hand reversed
SQ, \square	Square
WT	Weight
/UNIT	Number of items per basic unit of sale (bagged or boxed)
/BOX, /BAG	Number of UNITS found in an inner carton or bag
/CASE	Number of BOXES or UNITS found in an outer (shipping) carton

LEGEND

	Tested to Canadian and/or American safety and performance standards by Underwriters Laboratories® (UL).
 	Hinge available with rounded corners at indicated radius.
	Hinge mounting holes follow template hole pattern outlined by ANSI/BHMA A156.7.



COMMERCIAL HINGES

FULL MORTISE HINGES

DOREX BB1079 BALL BEARING TEMPLATE HINGE

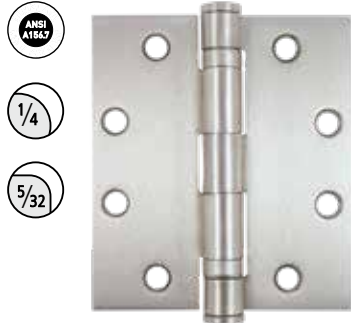

- Standard weight, full mortise
- 5 knuckles, 2 ball bearings
- Steel with steel pin
- Conforms to ANSI/BHMA A156.1
- ANSI/BHMA A156.7 template hole pattern

OPTIONS

- NRP: Non-removable pin
- A: NRP, radius corners: 1/4" (6.4 mm)*
- B: NRP, radius corners: 5/32" (4 mm)*

(*) Radius corners are only available for size 454 (4x4 1/2 in) hinges.

- Non-handed
- Flat tips with knock-out bottom
- Wood and undercut machine screws included

BB1079 - 454 - * - 26D - NRP

MODEL	SIZE	CORNER	FINISH	OPTION
(*) LEAVE BLANK FOR SQUARE CORNERS.				

(*) LEAVE BLANK FOR SQUARE CORNERS.

SIZE	INCHES	MM	GAUGE	HOLES	SCREWS INCLUDED		QTY ¹
					MACHINE	WOOD	
3535*	3 1/2 x 3 1/2	88.9 x 88.9	0.123	6	#10-24 x 1/2	#9 x 1	3/60
44*	4 x 4	101.6 x 101.6	0.130	8	#12-24 x 1/2	#12 x 1 1/4	3/60
454*	4 1/2 x 4	114.3 x 101.6	0.134	8	#12-24 x 1/2	#12 x 1 1/4	3/60
4545*	4 1/2 x 4 1/2	114.3 x 114.3	0.134	8	#12-24 x 1/2	#12 x 1 1/4	3/60
545*	5 x 4 1/2	127 x 114.3	0.146	8	#12-24 x 1/2	#12 x 1 1/4	3/30
55*	5 x 5	127.0 x 127.0	0.146	8	#12-24 x 1/2	#12 x 1 1/4	3/36

(1) 3/60: QUANTITY PER BOX / QUANTITY PER CASE. HINGES NOT SOLD INDIVIDUALLY. (*) FIRE RATING AS PER NFPA80 GUIDELINES.

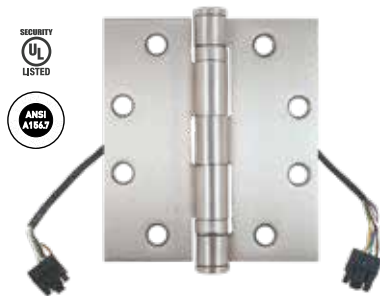

4-WIRE (28 AWG)
JC-603QC-BB1079-454-26D-ETW04

8-WIRE (28 AWG)
JC-603QC-BB1079-454-26D-ETW08

For more information, see page 04.620

1D	15	2G	26	26D	32D ¹	BLR	P
MATTE BLACK LACQUER	SATIN NICKEL	ZINC PLATED	POLISHED CHROME	SATIN CHROME	SATIN STAINLESS STEEL	DARK BRONZE	PRIME COATED

OTHER SIZES AND FINISHES AVAILABLE BY SPECIAL ORDER, PLEASE CONTACT FOR DETAILS.

(1) AVAILABLE ONLY FOR 454 AND 55 SIZES WITH NRP.

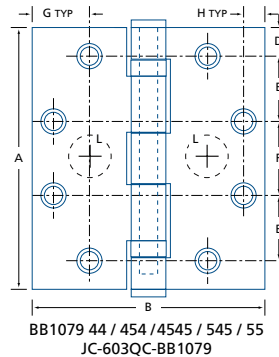
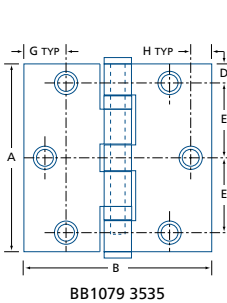

MODEL	A	B	C	D	E	F	G	H	K	L*
BB1079 3535	3 1/2 (88.9)	3 1/2 (88.9)	1/2 (12.7)	23/64 (9.1)	1 25/64 (35.4)	—	1 1/16 (17.5)	23/64 (9.1)	1/16 (1.6)	—
BB1079 44	4 (101.6)	4 (101.6)	9/16 (14)	1/2 (12.7)	1 (25.5)	31/32 (24.6)	3/4 (19.1)	3/8 (9.5)	1/16 (1.6)	—
BB1079 454 JC-603QC	4 1/2 (114.3)	4 (101.6)	19/32 (15.2)	1/2 (12.7)	1 1/8 (28.6)	1 15/64 (31)	1 (25.4)	3/8 (9.5)	1/16 (1.6)	Ø 19/32 (15)
BB1079 4545	4 1/2 (114.3)	4 1/2 (114.3)	19/32 (15.2)	1/2 (12.7)	1 1/8 (28.6)	1 15/64 (31)	1 (25.4)	3/8 (9.5)	1/16 (1.6)	—
BB1079 545	5 (127.0)	4 1/2 (114.3)	5/8 (15.9)	1/2 (12.7)	1 1/4 (31.8)	1 31/64 (37.7)	1 (25.4)	3/8 (9.5)	1/16 (1.8)	—
BB1079 55	5 (127)	5 (127)	5/8 (15.9)	1/2 (12.7)	1 1/4 (31.8)	1 31/64 (37.7)	1 (25.4)	3/8 (9.5)	1/16 (1.6)	—

DIMENSIONS IN INCHES (MILLIMETRES) AS PER ANSI A156.7

*DIMENSION OF THE NODE, NOT THE FRAME PREPARATION.

COMMERCIAL HINGES

FULL MORTISE HINGES

DOREX CB1079 CONCEALED BALL BEARING TEMPLATE HINGE



- Standard weight, full mortise
- 3 knuckles, concealed ball bearing
- Steel or stainless steel hinge and pin
- Conforms to ANSI/BHMA A156.1
- ANSI/BHMA A156.7 template hole pattern
- Non-handed
- Flush tips
- Wood and undercut machine screws included

CB1079	C26D	454	NRP
MODEL	FINISH	SIZE	OPTION

SIZE	INCHES	MM	GAUGE	HOLES	SCREWS INCLUDED MACHINE	SCREWS INCLUDED WOOD	QTY ¹
454*	4 1/2 x 4	114.3 x 101.6	0.134	8	#12-24 x 1/2	#12 x 1 1/4	3/60

(1) 3/60 : QUANTITY PER BOX / QUANTITY PER CASE. HINGES NOT SOLD INDIVIDUALLY. (*) FIRE RATING AS PER NFPA80 GUIDELINES.

C26D
SATIN
CHROME

OTHER SIZES AND FINISHES AVAILABLE BY SPECIAL ORDER, PLEASE CONTACT FOR DETAILS.
 (1) ALL SATIN STAINLESS STEEL HINGES (C32D) ARE 18-8 STAINLESS STEEL AND ARE NRP BY DEFAULT.

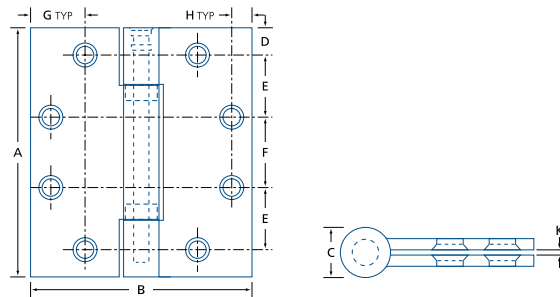

MODEL	A	B	C	D	E	F	G	H	K
CB1079 454	4 1/2 (114.3)	4 (101.6)	19/32 (15.2)	1/2 (12.7)	1 1/8 (28.6)	1 15/64 (31)	1 (25.4)	3/8 (9.5)	1/16 (1.6)

DIMENSIONS IN INCHES (MILLIMETRES) AS PER ANSI A156.7



COMMERCIAL HINGES

FULL MORTISE HINGES

DOREX PRO 1168 HEAVY DUTY BALL BEARING TEMPLATE HINGE



- Heavy weight, full mortise
- 5 knuckles, 4 ball bearings
- Steel or stainless steel hinge and pin
- Conforms to ANSI/BHMA A156.1
- ANSI/BHMA A156.7 template hole pattern

OPTIONS

B: Radius corners: $\frac{5}{32}$ " (4mm)

- Non-handed
- Flat tips with knock-out bottom
- Non-removable pin (NRP)
- Wood screws and undercut machine screws included

1168	C32D	454	B
MODEL	FINISH	SIZE	OPTION

SIZE	INCHES	MM	GAUGE	HOLES	SCREWS INCLUDED		QTY ¹
					MACHINE	WOOD	
454*	4½ x 4	114.3 x 101.6	0.1875	8	#12-24 x ½	#12 x 1¼	3/60

(1) 3/60 : QUANTITY PER BOX / QUANTITY PER CASE. HINGES NOT SOLD INDIVIDUALLY. (*) FIRE RATING AS PER NFPA80 GUIDELINES.

C15	C32D
SATIN NICKEL	SATIN STAINLESS STEEL

OTHER SIZES AND FINISHES AVAILABLE BY SPECIAL ORDER, PLEASE CONTACT FOR DETAILS.

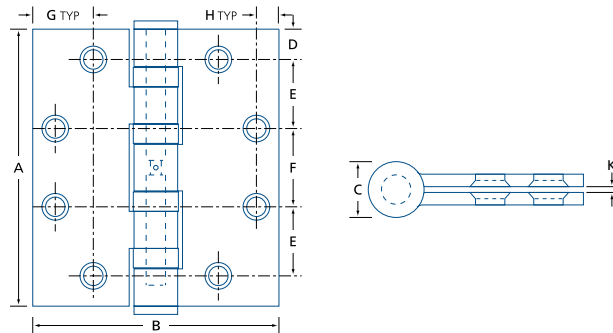

MODEL	A	B	C	D	E	F	G	H	K
1168 454	4½ (114.3)	4 (101.6)	$\frac{19}{32}$ (15.2)	½ (12.7)	1⅞ (28.6)	1⅝ ₆₄ (31)	1 (25.4)	¾ (9.5)	⅛ (1.6)

DIMENSIONS IN INCHES (MILLIMETRES) AS PER ANSI A156.7

COMMERCIAL HINGES

FULL MORTISE HINGES

DOREX 1198 HEAVY DUTY BALL BEARING TEMPLATE HINGE



- Heavy weight, full mortise
- 5 knuckles, 4 ball bearings
- Steel or stainless steel hinge and pin
- Conforms to ANSI/BHMA A156.1
- ANSI/BHMA A156.7 template hole pattern
- Non-handed
- Flat tips with knock-out bottom
- Non-removable pin (NRP)
- Wood screws and undercut machine screws included

1198	C26D	454
MODEL	FINISH	SIZE

SIZE	INCHES	MM	GAUGE	HOLES	SCREWS INCLUDED		QTY ¹
					MACHINE	WOOD	
454*	4 1/2 x 4	114.3 x 101.6	0.1875	8	#12-24 x 1/2	#12 x 1 1/4	3/60

(1) 3/60 : QUANTITY PER BOX / QUANTITY PER CASE. HINGES NOT SOLD INDIVIDUALLY. (*) FIRE RATING AS PER NFPA80 GUIDELINES.

C26D	C32D
SATIN CHROME	SATIN STAINLESS STEEL

OTHER SIZES AND FINISHES AVAILABLE BY SPECIAL ORDER, PLEASE CONTACT FOR DETAILS.

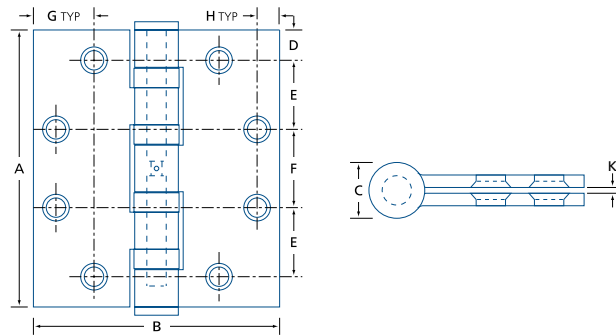

MODEL	A	B	C	D	E	F	G	H	K
1198 454	4 1/2 (114.3)	4 (101.6)	19/32 (15.2)	1/2 (12.7)	1 1/8 (28.6)	1 15/64 (31)	1 (25.4)	3/8 (9.5)	1/16 (1.6)

DIMENSIONS IN INCHES (MILLIMETRES) AS PER ANSI A156.7



COMMERCIAL HINGES

FULL MORTISE HINGES

DOREX BB1068 HEAVY DUTY BALL BEARING TEMPLATE HINGE



- Heavy weight, full mortise
- 5 knuckles, 4 ball bearings
- Steel or stainless steel hinge and pin
- Conforms to ANSI/BHMA A156.1
- ANSI/BHMA A156.7 template hole pattern
- Non-handed
- Flat tips with knock-out bottom
- Wood screws and undercut machine screws included

OPTIONS

NRP: Non-removable pin (NRP)

BB1068	- 4545	- 26D	- NRP
MODEL	SIZE	FINISH	OPTION

SIZE	INCHES	MM	GAUGE	HOLES	SCREWS INCLUDED		QTY ¹
					MACHINE	WOOD	
4545*	4½ x 4½	114.3 x 114.3	0.180	8	#12-24 x ½	#12 x 1¼	3/48
545*	5 x 4½	127 x 114.3	0.190	8	#12-24 x ½	#12 x 1¼	3/48
55*	5 x 5	127 x 127	0.190	8	#12-24 x ½	#12 x 1¼	3/48

(1) 3/48 : QUANTITY PER BOX / QUANTITY PER CASE. HINGES NOT SOLD INDIVIDUALLY. (*) FIRE RATING AS PER NFPA80 GUIDELINES.

P	26D	32D
PRIME COATED	SATIN CHROME	SATIN STAINLESS STEEL

OTHER SIZES AND FINISHES AVAILABLE BY SPECIAL ORDER, PLEASE CONTACT FOR DETAILS.

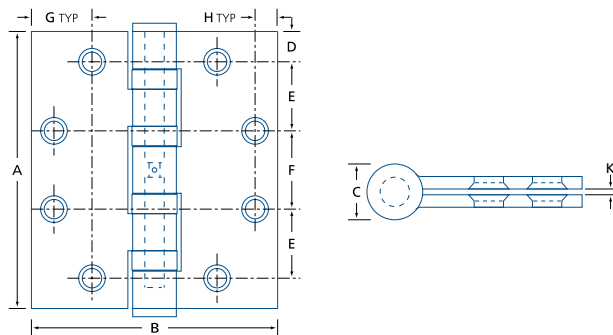

MODEL	A	B	C	D	E	F	G	H	K
BB1068 4545	4½ (114.3)	4½ (114.3)	¾ (19)	½ (12.7)	1⅞ (28.6)	1⅞ ₆₄ (31)	1 (25.4)	⅜ (9.5)	⅛ (1.8)
BB1068 545	5 (127.0)	4½ (114.3)	¾ (19)	½ (12.7)	1⅞ (28.6)	1⅞ ₆₄ (31)	1 (25.4)	⅜ (9.5)	⅛ (1.8)
BB1068 55	5 (127.0)	5 (127.0)	¾ (19)	½ (12.7)	1¼ (31.8)	1⅞ ₃₂ (37.7)	1 (25.4)	⅜ (9.5)	⅛ (1.8)

DIMENSIONS IN INCHES (MILLIMETRES) AS PER ANSI A156.7

COMMERCIAL HINGES

FULL MORTISE HINGES

DOREX 143 PLAIN BEARING TEMPLATE HINGE



- Standard weight, full mortise
- 5 knuckles, plain bearing
- Steel with non-rising steel pin
- ANSI/BHMA A156.7 template hole pattern
- Non-handed
- Flat tips with knock-out bottom
- Wood and undercut machine screws included

143	C15	454
MODEL	FINISH	SIZE

SIZE	INCHES	MM	GAUGE	HOLES	SCREWS INCLUDED MACHINE	WOOD	QTY ¹
454	4½ x 4	114.3 x 101.6	0.134	8	#12-24 x ½	#12 x 1¼	3/60

(1) 3/60 : QUANTITY PER BOX / QUANTITY PER CASE. HINGES NOT SOLD INDIVIDUALLY.

C15
SATIN NICKEL

OTHER SIZES AND FINISHES AVAILABLE BY SPECIAL ORDER, PLEASE CONTACT FOR DETAILS.

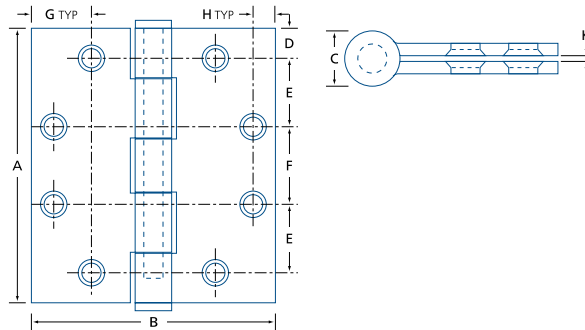

MODEL	A	B	C	D	E	F	G	H	K
143 454	4½ (114.3)	4 (101.6)	19/32 (15.2)	½ (12.7)	1⅛ (28.6)	1¹⁵/₆₄ (31)	1 (25.4)	¾ (9.5)	⅛ (1.6)

DIMENSIONS IN INCHES (MILLIMETRES) AS PER ANSI A156.7

COMMERCIAL HINGES

FULL MORTISE HINGES

DOREX 1079/1091 PLAIN BEARING TEMPLATE HINGE



- Standard weight, full mortise
- 5 knuckles, plain bearing
- Steel or stainless steel hinge and pin
- ANSI/BHMA A156.7 template hole pattern

- Non-handed
- Flat tips with knock-out bottom
- Wood and undercut machine screws included

MODELS

- 1079: Steel hinge and pin
- 1091: Stainless steel hinge and pin

OPTIONS

- N: Non-removable pin (NRP)

1079	-	44	-	26D	-	N
MODEL		SIZE		FINISH		OPTION

SIZE	INCHES	MM	GAUGE	HOLES	SCREWS INCLUDED		QTY ¹
					MACHINE	WOOD	
3535	3½ x 3½	88.9 x 88.9	0.125	6	#10-24 x ½	#9 x 1	3/48
44	4 x 4	101.6 x 101.6	0.130	8	#12-24 x ½	#12 x 1¼	3/48
4545	4½ x 4½	114.3 x 114.3	0.134	8	#12-24 x ½	#12 x 1¼	3/48

(1) 3/48 : QUANTITY PER BOX / QUANTITY PER CASE. HINGES NOT SOLD INDIVIDUALLY.

P	26D	32D*
PRIME COATED	SATIN CHROME	SATIN STAINLESS STEEL

OTHER SIZES AND FINISHES AVAILABLE BY SPECIAL ORDER, PLEASE CONTACT FOR DETAILS.
 (*) 304 STAINLESS STEEL, 1091-4545 ONLY

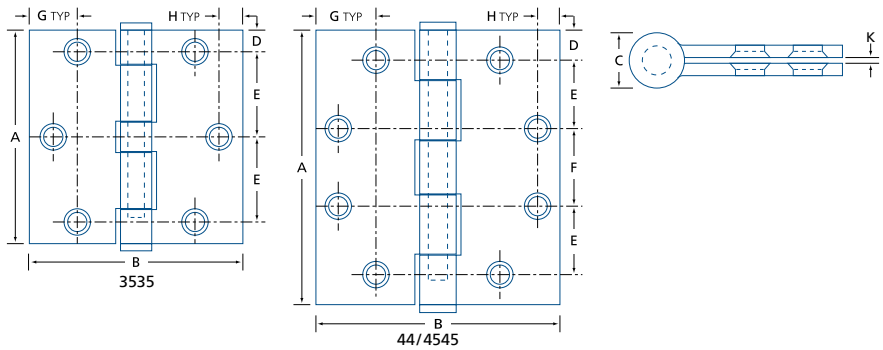

MODEL	A	B	C	D	E	F	G	H	K
1079/1091 3535	3½ (88.9)	3½ (88.9)	½ (12.7)	23/64 (9.1)	125/64 (35.4)	—	11/16 (17.5)	23/64 (9.1)	1/16 (1.6)
1079/1091 44	4 (101.6)	4 (101.6)	9/16 (14)	½ (12.7)	1 (25.5)	31/32 (24.6)	3/4 (19.1)	3/8 (9.5)	1/16 (1.6)
1079/1091 4545	4½ (114.3)	4½ (114.3)	19/32 (15.2)	½ (12.7)	1 1/8 (28.6)	1 15/64 (31)	1 (25.4)	3/8 (9.5)	1/16 (1.6)

DIMENSIONS IN INCHES (MILLIMETRES) AS PER ANSI A156.7

COMMERCIAL HINGES

HALF SURFACE HINGES

DOREX BB1073 HALF SURFACE TEMPLATE HINGE



- Standard weight, half surface
- 5 knuckles, 2 ball bearings
- Steel with steel pin
- ANSI/BHMA A156.7 template hole pattern
- Handed
- Flat tips with knock-out bottom
- Non-removable pin (NRP)
- High quality primer coat finish (CP)

BB1073	L	-	45	-	P	-	N
MODEL	HAND	SIZE	FINISH				

L : LEFT HAND R : RIGHT HAND

SIZE	HINGE SIZE INCHES	MM	GAUGE	HOLES	BOLT / SCREWS INCLUDED BOLT	WOOD	QTY ¹
45	4 1/2	114.3	0.134	7	#1/4 x 20 (x3)*	#12 x 1 1/4 (x4)	3/48
50	5	127	0.146	8	#1/4 x 20 (x3)*	#12 x 1 1/4 (x4)	3/48

(*) FOR DOORS 1 3/4" (45MM) THICK (1) 3/48 : QUANTITY PER BOX / QUANTITY PER CASE. HINGES NOT SOLD INDIVIDUALLY.

P
PRIME COATED

OTHER SIZES AND FINISHES AVAILABLE BY SPECIAL ORDER, PLEASE CONTACT FOR DETAILS.

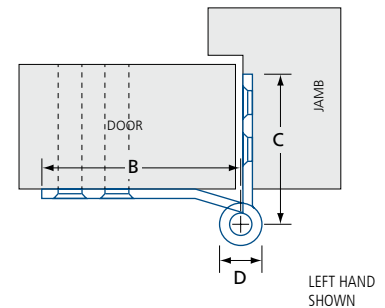
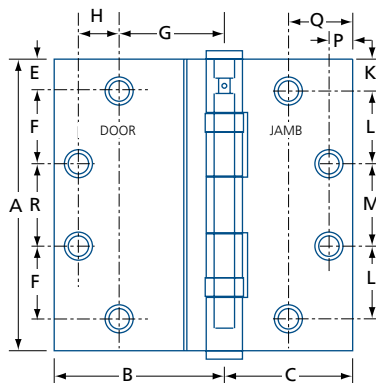
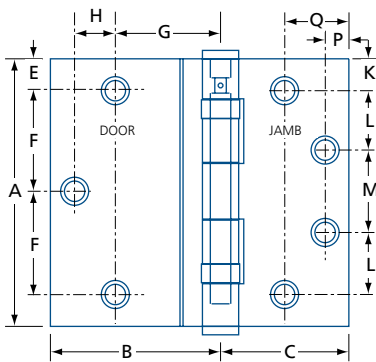

MODEL	A	B	C	D	E	F	G	H	K	L	M	P	Q	R
BB1073 45	4 1/2 (114.3)	2 9/16 (65)	2 1/16 (52.4)	39/64 (15.4)	1/2 (12.7)	1 3/4 (44.5)	1 1/2 (38.1)	9/16 (14.3)	1/2 (12.7)	1 1/8 (28.6)	1 7/32 (31.3)	3/8 (9.5)	1 (25.4)	—
BB1073 50	5 (127)	2 7/8 (73.0)	2 1/16 (52.4)	5/8 (15.8)	1/2 (12.7)	1 1/4 (31.8)	1 1/2 (38.1)	7/8 (22.2)	1/2 (12.7)	1 1/4 (31.8)	1 31/64 (37.7)	3/8 (9.5)	1 (25.4)	1 1/2 (38.1)

IN(MM)

COMMERCIAL HINGES

HALF MORTISE HINGES

DOREX BB1077 HALF MORTISE TEMPLATE HINGE



- Standard weight, half mortise
- 5 knuckles, 2 ball bearings
- Steel with steel pin
- ANSI/BHMA A156.7 template hole pattern
- Handed
- Flat tips with knock-out bottom
- Wood and undercut machine screws and through-bolts included

OPTIONS

N: Non-removable pin (NRP)

BB1077	L	-	45	-	P	-	N
MODEL	HAND	SIZE	FINISH				

L : LEFT HAND R : RIGHT HAND

SIZE	HINGE SIZE		GAUGE	HOLES	BOLT / SCREWS INCLUDED		QTY ¹
	INCHES	MM			BOLT	WOOD	
45	4 1/2	114.3	0.134	7	#1/4x20 (x3)*	#12x1 1/4(x4)	3/48

(*) FOR DOORS 1 3/4" (45 MM) THICK (1) 3/48 : QUANTITY PER BOX / QUANTITY PER CASE. HINGES NOT SOLD INDIVIDUALLY.

P
PRIME COATED

OTHER SIZES AND FINISHES AVAILABLE BY SPECIAL ORDER, PLEASE CONTACT FOR DETAILS.

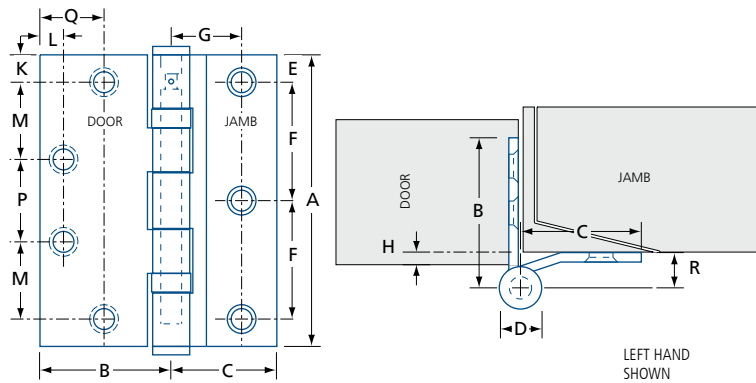

MODEL	A	B	C	D	E	F	G	H	K	L	M	P	Q
BB1077 45	4 1/2	2 1/16	1 1/2	19/32	1/2	1 3/4	1	—	1/2	3/8	1 1/8	17/32	1
	(114.3)	(52.4)	(38)	(15)	(12.7)	(44.5)	(25.4)		(12.7)	(9.5)	(28.6)	(31.3)	(25.4)

IN (MM)



COMMERCIAL HINGES

SWING CLEAR HINGES

DOREX BB1048 SWING CLEAR TEMPLATE HINGE



- Standard weight
- 5 knuckles, 2 ball bearings
- Steel with non-rising steel pin
- ANSI/BHMA A156.7 template hole pattern
- Allows door to fully clear door opening
- For non-bevelled (square) doors
- Handed, field reversible
- Flat tips with knock-out bottom

BB1048 L - 454 - 15

MODEL HAND SIZE FINISH

L: LEFT HAND R: RIGHT HAND

SIZE	INCHES	MM	GAUGE	HOLES	SCREWS INCLUDED		QTY ¹
					MACHINE	WOOD	
454*	4 1/2 x 4	114.3 x 101.6	0.134	8	#12-24 x 1/2	#12 x 1 1/4	3/30

(1) 3/30 : QUANTITY PER BOX / QUANTITY PER CASE. HINGES NOT SOLD INDIVIDUALLY. (*) FIRE RATING AS PER NFPA80 GUIDELINES. OTHER FINISHES AVAILABLE BY SPECIAL ORDER, PLEASE CONTACT FOR DETAILS.

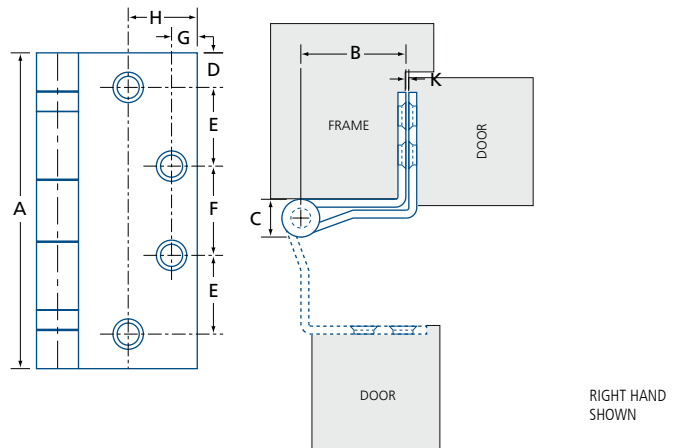

MODEL	A	B	C	D	E	F	G	H	K
BB1048 454	4 1/2 (114.3)	1 5/8 (41.3)	19/32 (15.2)	1/2 (12.9)	1 1/8 (28.6)	1 15/64 (31.3)	3/8 (9.5)	1 (25.4)	1/16 (1.6)

IN(MM)

COMMERCIAL HINGES

REINFORCEMENT HINGES & PLATES

DOREX PRO 1265 REINFORCEMENT HINGE



1265RH

- Heavy weight, full surface
 - 2 knuckles, 1 ball bearings
 - Steel with steel fixed pin
- Reinforces sagging or unevenly hung doors
 - Handed
 - Mounting hardware:
 - » Wood screws
 - » Machine screws
 - » Thru-bolts with sexnut for 1 3/4" (44.5) door
 - » Threaded Jack-Nut inserts with installation tool

1265	RH
MODEL	HAND

LH : LEFT HAND RH : RIGHT HAND

MODEL	HINGE SIZE		FINISH	HOLES	SCREWS INCLUDED		QTY ¹
	INCHES	MM			WOOD	MACHINE	
1265	3 1/4 x 6 1/8	82.6 x 155.7	Satin zinc plated	9	1/4 x 1 1/2	1/4-20 x 1	1/30

(1) 1/30 : QUANTITY PER BOX / QUANTITY PER CASE.

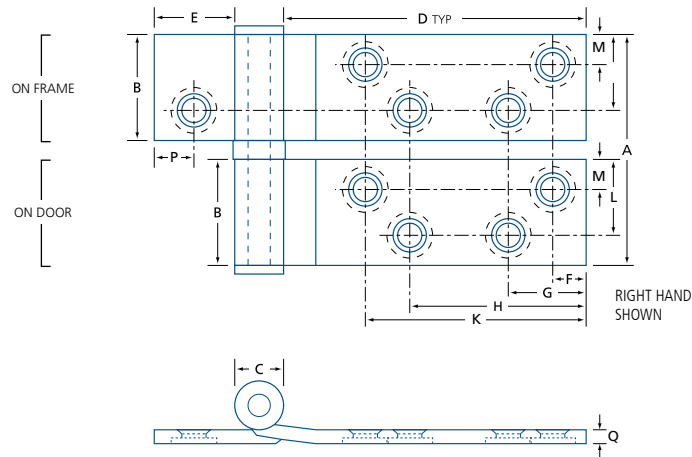

MODEL	A	B	C	D	E	F	G	H	K	M	P	Q
1265	3 1/4 (82.5)	1 1/2 (38.1)	1 1/16 (17.5)	4 9/16 (109)	1 5/32 (29.1)	1/2 (12.7)	1 1/8 (28.6)	2 3/8 (60.30)	3 (76.2)	1/2 (12.7)	5/8 (16)	0.190 (4.8)

IN (MM)

COMMERCIAL HINGES

REINFORCEMENT & FILLER PLATES

DOREX REINFORCEMENT & FILLER PLATES

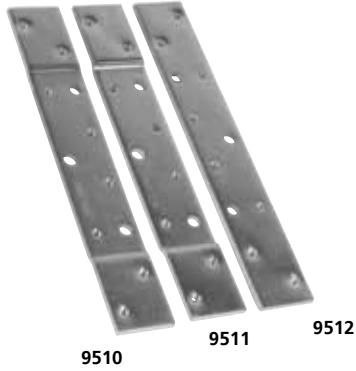

- Steel reinforcement plate
- ANSI/BHMA A156.7 template hole pattern
- Available with various offsets
- Holes accommodate #12-24 screws
- Fastening hardware NOT included

MODEL	FINISH	DESCRIPTION	QTY ¹
9510	Zinc plated	8 x 1 ³ / ₁₆ " (201 x 30 mm) Template reinforcement plate for 4 ¹ / ₂ " (114.3) hinge, with ³ / ₃₂ " (2.5) offset	12/120
9511	Zinc plated	8 x 1 ³ / ₁₆ " (201 x 30 mm) Template reinforcement plate for 4 ¹ / ₂ " (114.3 mm) hinge, with ¹ / ₁₆ " (1.2 mm) offset	12/120
9512	Zinc plated	8 x 1 ³ / ₁₆ " (201 x 30 mm) Template reinforcement plate for 4 ¹ / ₂ " (114.3 mm) hinge, flat, no offset	12/120

(1) 12/120 : QUANTITY PER BOX / QUANTITY PER CASE.



- Steel filler plate
- ANSI/BHMA A156.7 template hole pattern
- Holes accommodate #12-24 screws
- Fastening hardware included

MODEL	FINISH	DESCRIPTION	QTY ¹
9515EXW	White epoxy	Template filler plate for 4 ¹ / ₂ x 1 ¹ / ₂ " (114.3 x 38 mm) hinge leaf	50/150
9515ZP	Zinc plated		

(1) 50/150 : QUANTITY PER BOX / QUANTITY PER CASE.

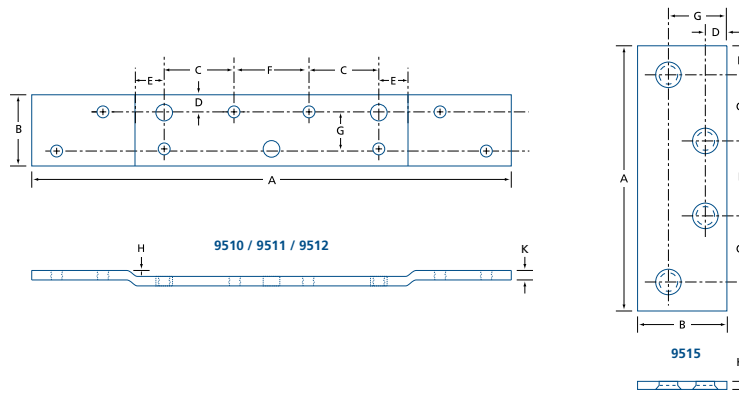

MODEL	A	B	C	D	E	F	G	H	K
9510	7 ¹⁵ / ₁₆ (202)	1 ³ / ₁₆ (30)	1 ¹ / ₈ (28.6)	1 ⁷ / ₆₄ (6.7)	1 ⁷ / ₃₂ (13.5)	1 ¹⁵ / ₆₄ (31)	5/ ₈ (15)	3 ³ / ₃₂ (2.5)	5 ₃₂ (4)
9511	7 ¹⁵ / ₁₆ (202)	1 ³ / ₁₆ (30)	1 ¹ / ₈ (28.6)	1 ⁷ / ₆₄ (6.7)	1 ⁷ / ₃₂ (13.5)	1 ¹⁵ / ₆₄ (31)	5/ ₈ (15)	1 ₁₆ (1.2)	5 ₃₂ (4)
9512	7 ¹⁵ / ₁₆ (202)	1 ³ / ₁₆ (30)	1 ¹ / ₈ (28.6)	1 ⁷ / ₆₄ (6.7)	1 ⁷ / ₃₂ (13.5)	1 ¹⁵ / ₆₄ (31)	5/ ₈ (15)	—	5 ₃₂ (4)
9515	4 1 ₂ (114.3)	1 ¹ / ₂ (38.1)	1 ¹ / ₈ (28.6)	3/ ₈ (9.5)	3 ³ / ₆₄ (13.1)	1 ¹⁵ / ₆₄ (31)	1 (25.4)	—	5 ₃₂ (4)

DIMENSIONS IN INCHES (MILLIMETRES) AS PER ANSI A156.7



COMMERCIAL HINGES

SPRING HINGES

DOREX PRO 3310 SINGLE ACTION SPRING HINGES



- Standard weight, full mortise
- 3 knuckle, 2 anti-friction nylon washers
- Steel with steel components
- ANSI/BHMA A156.7 template hole pattern
- cULus listed¹

- Non-handed
- Adjustable spring tension (tool included)
- Wood and/or undercut machine screws included

OPTIONS

3311: Radius corners: 1/4" (6.4 mm)

NOTE: For best results, use with DOREX PRO ball bearing hinges of the same size.

(1) Minimum of two (2) 3310 hinges per labelled fire door



3310	C15	454
MODEL	FINISH	SIZE

SIZE	INCHES	MM	GAUGE	FIRE RATING*	HOLES	SCREWS INCLUDED MACHINE	WOOD	QTY ¹
3535	3 1/2 x 3 1/2	88.9 x 88.9	0.125	90 min.	6	—	#9 x 3/4	2 / 40
44	4 x 4	101.6 x 101.6	0.125	90 min.	8	—	#9 x 3/4	2 / 40
44	4 x 4 (RC)	101.6 x 101.6 (RC)	0.125	90 min.	8	—	#10 x 3/4	2 / 40
454	4 1/2 x 4	114.3 x 101.6	0.134	180 min.	8	#12-24 x 1/2	#12 x 1 1/4	2 / 40

(*) MAX. FIRE RATING BASED ON NFPA80 GUIDELINES. (1) 2/40 : QUANTITY PER BOX / QUANTITY PER CASE. HINGES NOT SOLD INDIVIDUALLY. (RC) RADIUS CORNERS.

C15	C26D	C3	C3M	C5
SATIN NICKEL	SATIN CHROME	POLISHED BRASS	MIRROR POLISH BRASS	ANTIQUÉ BRASS

OTHER FINISHES AVAILABLE, MAY REQUIRE SPECIAL ORDER AND/OR ADDITIONAL LEAD TIME.

CAUTION: Misaligned and/or twisted door frames or doors, door bottoms or gasketing for smoke, sound, weather, air pressure differences or improper latch installation/adjustment may prevent door from latching. Some installations may require additional spring hinges.

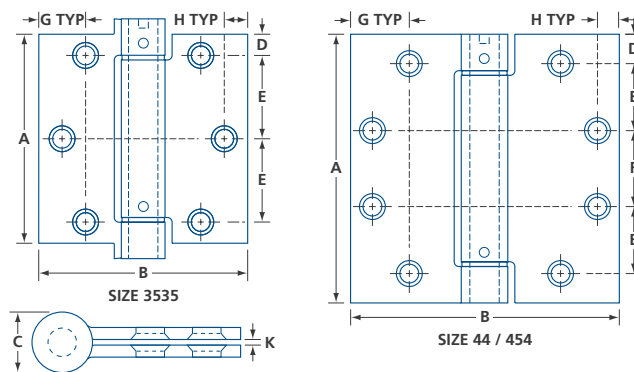

SIZE	MAXIMUM DOOR WT. ¹	SPRING HINGES	BUTT HINGES ²
3535	50 (22.7)	1	2
	70 (31.8)	2	1
	80 (36.3)	3	—
44	60 (27.2)	1	2
	85 (38.6)	2	1
	100 (45.5)	3	—
454	70 (31.8)	1	2
	90 (40.9)	2	1
	120 (54.5)	3	—

(1) LB(KG) MAXIMUM SIZE: 48 X 90" (1219 X 2286 MM). MAX. FIRE DOOR SIZE: 36 X 84" (914 X 2134 MM).

(2) FOR BEST RESULTS, USE DOREX PRO179 HINGES OF THE SAME SIZE.

MODEL	A	B	C	D	E	F	G	K
3310 3535	3 1/2 (88.9)	3 1/2 (88.9)	1 1/16 (17.5)	23/64 (9.1)	125/64 (35.4)	—	1 1/16 (17.5)	1/16 (1.6)
3310/11 44	4 (101.6)	4 (101.6)	1 1/16 (17.5)	1/2 (12.7)	1 (25.5)	31/32 (24.6)	3/4 (19.1)	1/16 (1.6)
3310 454	4 1/2 (114.3)	4 (101.6)	25/32 (19.6)	1/2 (12.7)	1 1/8 (28.6)	1 15/64 (31)	1 (25.4)	1/16 (1.6)

DIMENSIONS IN INCHES (MILLIMETRES) AS PER ANSI A156.7

COMMERCIAL HINGES

REINFORCEMENT & FILLER PLATES

1310 SINGLE ACTION SPRING HINGES



- Standard weight, full mortise
- 3 knuckle, 2 anti-friction nylon washers
- Steel with steel components
- ANSI/BHMA A156.7 template hole pattern
- cULus listed¹

- Non-handed
- Adjustable spring tension (tool included)
- Wood and/or undercut machine screws included

NOTE: For best results, use with ball bearing hinges of the same size.

(1) Minimum of two (2) 1310 hinges per labelled fire door



1310	C15	454
MODEL	FINISH	SIZE

SIZE	INCHES	MM	GAUGE	FIRE RATING*	HOLES	SCREWS INCLUDED MACHINE	WOOD	QTY ¹
454	4 1/2 x 4	114.3 x 101.6	0.134	180 min.	8	#12-24 x 1/2	#12 x 1 1/4	2 / 48

(*) MAX. FIRE RATING BASED ON NFPA 80 GUIDELINES. (1) 2/48 : QUANTITY PER BOX / QUANTITY PER CASE. HINGES NOT SOLD INDIVIDUALLY.

C15	C1D	C26D
SATIN NICKEL	MATTE BLACK	SATIN CHROME

OTHER FINISHES AVAILABLE, MAY REQUIRE SPECIAL ORDER AND/OR ADDITIONAL LEAD TIME.

CAUTION: Misaligned and/or twisted door frames or doors, door bottoms or gasketing for smoke, sound, weather, air pressure differences or improper latch installation/adjustment may prevent door from latching. Some installations may require additional spring hinges.

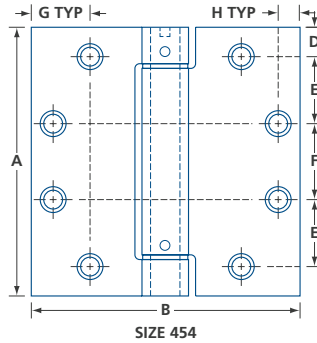

SIZE	MAXIMUM DOOR WT. ¹	SPRING HINGES	BUTT HINGES ²
454	110 (50.0)	2	1
	120 (54.5)	3	—

(1) LB(KG) MAXIMUM SIZE: 48 X 90" (1219 X 2286 MM).

MAX. FIRE DOOR SIZE: 36 X 84" (914 X 2134 MM).

(2) FOR BEST RESULTS, USE BALL BEARING HINGES OF THE SAME SIZE.

MODEL	A	B	C	D	E	F	G	H	K
1310 454	4 1/2 (114.3)	4 (101.6)	19/32 (15.2)	1/2 (12.7)	1 1/8 (28.6)	1 15/64 (31)	1 (25.4)	3/8 (9.5)	1/16 (1.6)

DIMENSIONS IN INCHES (MILLIMETRES) AS PER ANSI A156.7

COMMERCIAL HINGES

SPRING HINGES



4300 SERIES SINGLE ACTING TEMPLATE SPRING HINGES



4310
Square Corner

- BHMA Certified, Grade 1
- ANSI/BHMA A156.7 template hole pattern
- cULus listed for fire door application

- Non-handed
- Steel with steel components
- Self-lubricating bearings
- Adjustable spring tension
- Aligns with full mortise BOMMER hinges of the same size

Minimum 2 hinges per door.

4310 MODEL	C26D FINISH	454 SIZE
---------------	----------------	-------------

C15	C26D	C32D
SATIN NICKEL	SATIN CHROME	SATIN STAINLESS STEEL

OTHER FINISHES AVAILABLE. SOME SIZE/FINISH/OPTION COMBINATIONS MAY REQUIRE SPECIAL ORDER AND/OR ADDITIONAL LEAD TIME.

Available in a variety of architectural finishes, models and sizes – please contact to order or visit www.bommer.com for details



3000 SERIES DOUBLE ACTING SPRING HINGES



3029/3029A
Full Mortise

- Non handed
- Steel with steel components
- Adjustable spring tension
- Does not align with standard full mortise hinges
- Do not use on door with bevelled hinge edge
- ANSI/BHMA A156.7 template models available
- Box clamp flanges are NOT ADJUSTABLE, available for fixed door thicknesses only

Available in a variety of architectural finishes, models and sizes – please contact to order or visit www.bommer.com for details



COMMERCIAL HINGES

REINFORCEMENT & FILLER PLATES

DOREX UNIVERSAL REPLACEMENT HINGE

1020



- Non handed
- Surface mounted
- Anti-friction ball bearings for smooth pin rotation
- Precision machined, extruded aluminum
- For aluminum frame doors up to 300 lbs (136 kg)
- $\frac{1}{8}$ " (3 mm) Vertical door adjustment
- Can accommodate $\frac{1}{8}$ " (3 mm) recessed doors
- Easy installation

INCLUDES

- (2) Hinges
- (2) #1020S $\frac{1}{8}$ " (3 mm) shim plates (matching finish)
- (4) Adhesive cover strips (matching finish)
- (1) Hex key
- (12) Tamper resistant fasteners

#1020SC Shim plate pairs available separately.

1020	C28
MODEL	FINISH

MODEL	HINGE SIZE INCHES	MM	GAUGE	HOLES	QTY ¹
1020	3 1/4 x 5	82.6 x 127	0.218	6	8 / 32

(1) 8 / 32 : QUANTITY PER INNER CARTON / QUANTITY PER CASE. HINGES SOLD IN PAIRS, NOT SOLD INDIVIDUALLY.

C20D	C28
DARK BRONZE	ALUMINUM

OTHER FINISHES AVAILABLE, MAY REQUIRE SPECIAL ORDER AND/OR ADDITIONAL LEAD TIME.

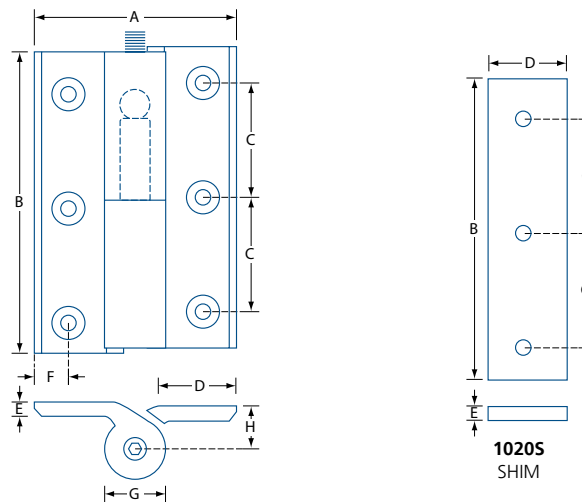

MODEL	A	B	C	D	E	F	G	H
1020	3 1/4 (82.6)	5 (127)	2 (50.8)	1 (25.4)	7/32 (5.6)	9/16 (14)	1 (25.4)	3/4 (19)
1020S	—	5 (127)	2 (50.8)	1 (25.4)	1/8 (3.2)	7/32 (5.6)	1 (25.4)	—

IN (MM)

RESIDENTIAL HINGES

BALL BEARING HINGES

B848 SERIES BALL BEARING HINGES

B848



B848 C15 33
3 x 3"
Square corners

- For wood door and frame applications
- Full mortise
- 5 knuckles, 2 ball bearings
- Steel hinge and pin
- Non-rising, removable pin
- Sold in boxed pairs
- Wood screws included

OPTIONS

-A: ¼" Radius corners (3535 only)



B848 C15 3535
3 ½ x 3 ½"
Square corners



B848 C15 3535 -A
3 ½ x 3 ½"
¼" (6.4 mm)
Radius Corners

B848	C15	3535	-A
MODEL	FINISH	SIZE	OPTION

SIZE	INCHES	MM	FINISH ¹	HOLES	WOOD SCREWS	QTY ²
33	3 x 3	76 x 76	C15	6	#8 x ¾"	2/100
3535	3 ½ x 3 ½	88.9 x 88.9	C15	6	#8 x ¾"	2/100

(1) OTHER FINISHES AVAILABLE (2) 2/100 : QUANTITY PER BOX / QUANTITY PER CASE. HINGES NOT SOLD INDIVIDUALLY.

BB2500 SERIES BALL BEARING HINGES

BB2589, BB2590



BB2589
3 ½ x 3 ½"
Square Corner

- For wood door and frame applications
- Full mortise
- 5 knuckles, 2 ball bearings
- Steel hinge and pin
- Non-rising, removable pin
- Sold in boxed pairs
- Wood screws included



BB2590
3 ½ x 3 ½"
¼" (6.4 mm)
Radius Corners

BB2589	C15	33	P
MODEL	FINISH	SIZE	

BB2589

SIZE	INCHES	MM	FINISH ¹	HOLES	SCREWS	/CASE ²
33	3 x 3	76.2 x 76.2	C15	6	#9 x ¾"	2/100
3535	3 ½ x 3 ½	88.9 x 88.9	C15	6	#9 x ¾"	2/100

(1) OTHER FINISHES AVAILABLE (2) 2/100 : QUANTITY PER BOX / QUANTITY PER CASE. HINGES NOT SOLD INDIVIDUALLY.

BB2590

SIZE	INCHES	MM	FINISH ¹	HOLES	SCREWS	/CASE ²
3535	3 ½ x 3 ½	88.9 x 88.9	C15, C26D	6	#9 x ¾"	2/100

(1) OTHER FINISHES AVAILABLE (2) 2/100 : QUANTITY PER BOX / QUANTITY PER CASE. HINGES NOT SOLD INDIVIDUALLY.

RESIDENTIAL HINGES

PLAIN BEARING HINGES

2500 SERIES RESIDENTIAL STEEL HINGES

2589, 2590, 2591



2589
Square Corner

- For wood door and frame applications
- Full mortise
- 5 knuckles, plain bearing
- Steel hinge and removable pin
- Unassembled hinge by default
- Wood screws included
- Packaged in bulk

OPTIONS

- A: Assembled hinge, with screws
- P: Boxed pair (assembled), with screws



2590
1/4" (6.4 mm)
Radius Corners

2589	C15	3535	A
MODEL	FINISH	SIZE	OPTION*
(*) LEAVE BLANK FOR UNASSEMBLED			

2589

SIZE	INCHES	MM	FINISH ¹	HOLES	SCREWS	/CASE ²
33	3 x 3	76.2 x 76.2	C15, C19, C2G	6	#9 x 3/4	100
3535	3 1/2 x 3 1/2	88.9 x 88.9	C15, C2G	6	#9 x 3/4	100
44	4 x 4	101.6 x 101.6	C2G	6	#9 x 3/4	100

(1) OTHER FINISHES AVAILABLE (2) 50 BOXED PAIRS OR 100 INDIVIDUAL HINGES.

2590

SIZE	INCHES	MM	FINISH ¹	HOLES	SCREWS	/CASE ²
33	3 x 3	76.2 x 76.2	C11P, C15, C15A, C19	6	#9 x 3/4	100
3535	3 1/2 x 3 1/2	88.9 x 88.9	C15, C26, C26D, C2G	6	#9 x 3/4	100

(1) OTHER FINISHES AVAILABLE (2) 50 BOXED PAIRS OR 100 INDIVIDUAL HINGES.



2591
3/8" (16 mm)
Radius Corners

2591

SIZE	INCHES	MM	FINISH ¹	HOLES	SCREWS	/CASE ²
33	3 x 3	76.2 x 76.2	C11P, C15, C15A, C19, C26, C26D, C2G, C3	6	#9 x 3/4	100
3535	3 1/2 x 3 1/2	88.9 x 88.9	C15, C19, C26D, C2G	6	#9 x 3/4	100

(1) OTHER FINISHES AVAILABLE (2) 50 BOXED PAIRS OR 100 INDIVIDUAL HINGES.

BULK ORDERS

Bulk or volume orders are available for original equipment manufacturers (OEM), project builds, and other contractors.

Custom options and non-stock finishes may require additional lead time or minimum quantity orders.

Please contact for details, including options, available sizes and finishes.

Common options include:

- Delivery without screws
- Delivery in split packaging
- Specific non-stock finish



RESIDENTIAL HINGES

PLAIN BEARING HINGES

DOREX STAINLESS STEEL HINGES

84



- For wood door and frame applications
- Full mortise
- 5 knuckles, plain bearing
- Stainless steel
- Removable pin
- Sold in boxed pairs
- Wood screws included

84	C32D	33
MODEL	FINISH	SIZE

SIZE	INCHES	MM	GUAGE	FINISH ¹	HOLES	SCREWS	QTY ²
33	3 x 3	76.2 x 76.2	2.3	C32D	6	#8 x 3/4	2 / 100
3535	3 1/2 x 3 1/2	88.9 x 88.9	2.3	C32D	6	#9 x 1	2 / 60

(1) OTHER FINISHES AVAILABLE (2) 2/100 : QUANTITY PER BOX / QUANTITY PER CASE. HINGES NOT SOLD INDIVIDUALLY.

RESIDENTIAL HINGES

ASSORTED HINGES

2600 SERIES DECORATIVE HINGES

2698



2698
 $\frac{3}{8}$ " (16 mm)
 Radius Corners
 Steeple Tip

- For wood door and frame applications
- Full mortise
- 5 knuckles, plain bearing
- Steel hinge and pin
- Sold in assembled pairs, boxed
- Wood screws included

2698	C19	33
MODEL	FINISH	SIZE

SIZE	INCHES	MM	FINISH ¹	HOLES	SCREWS	/CASE ²
33	3 x 3	76.2 x 76.2	C19	6	#9 x $\frac{3}{4}$	2/100

(1) OTHER FINISHES AVAILABLE (2) 2/100 : QUANTITY PER BOX / QUANTITY PER CASE. HINGES NOT SOLD INDIVIDUALLY.

LIGHT DUTY DOUBLE ACTING SPRING HINGE

9290



- For light duty residential applications
- Non handed
- Adjustable spring tension
- Does not align with standard full mortise hinges
- Do not use on door with bevelled hinge edge
- Sold in pairs
- Required fasteners included

9290	SDN	3
MODEL	FINISH	SIZE

SIZE	A	B	FINISH	DOOR THICKNESS	QTY ¹
3	3 (76)	$2\frac{23}{32}$ (69.4)	SDB, SDN	$1\frac{1}{4}$ (31.8)	2
4	4 (102)	$3\frac{25}{32}$ (95.8)	KJ, SDN	$1\frac{1}{4}$ (31.8)	2
5	5 (127)	$4\frac{5}{8}$ (117.4)	KJ, SDB, SDN	$1\frac{1}{2}$ (38.1)	2
6	6 (152)	$5\frac{9}{16}$ (141.4)	KJ, SDB, SDN	$1\frac{7}{8}$ (48.6)	2

IN (MM) (1) SOLD IN PAIRS. NOT SOLD INDIVIDUALLY.

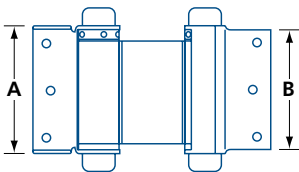

RESIDENTIAL HINGES

SCREEN DOOR SPRINGS



HALF SURFACE SCREEN DOOR SPRING HINGE

2930

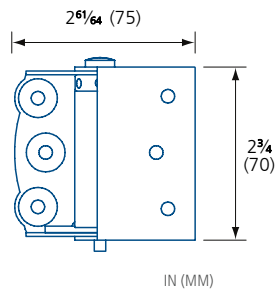

- Non-handed
- Steel hinge with loose pin
- Half surface (full surface model available)
- Available with reversible spring
- Adjustable spring tension
- Mounting hardware included

Available in a variety of architectural finishes and models – please contact to order or visit www.bommer.com for details

2930	C2G
MODEL	FINISH



FULL SURFACE SCREEN DOOR SPRING HINGE – ADJUSTABLE

2980

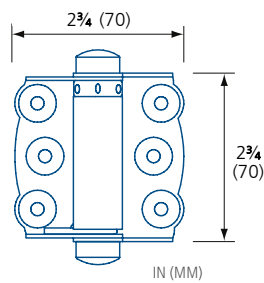

- Non-handed
- Steel hinge with button tip
- Full surface (half surface model available)
- Adjustable spring tension
- Mounting hardware included

Available in a variety of architectural finishes and models – please contact to order or visit www.bommer.com for details

2980	C2G
MODEL	FINISH

FULL SURFACE SCREEN DOOR SPRING HINGE

960

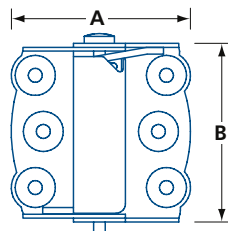

- Non-handed
- Steel hinge with fixed pin
- Full Surface
- Fixed spring tension (not adjustable)
- Mounting hardware included

960	ZP
MODEL	FINISH

MODEL	A	B	FINISH	/BOX	/CASE
960	3 (76)	2 ²³ / ₃₂ (69.4)	ZP	—	200
2960	4 (102)	3 ²⁵ / ₃₂ (95.8)	C2G	2	40



IN (MM)

RESIDENTIAL HINGES

DOOR SPRING



AUXILIARY DOOR SPRING

2430, 2520

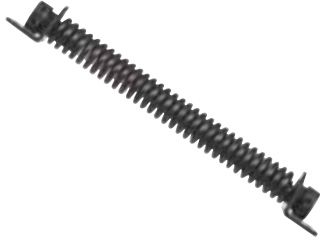

- Non-handed
- Economical closing device
- Adjustable spring tension
- Do not apply more than three (3) hole tension
- Maximum capacity: 50 lbs (22.7 kg)
- Mounting hardware included

Available in a variety of architectural finishes and models – please contact to order or visit www.bommer.com for details

2430	C1B
MODEL	FINISH



CONTINUOUS GEARED HINGES

FULL CONCEALED / HALF SURFACE

ABH FULL CONCEALED ALUMINUM GEARED HINGES

ABH-A110HD

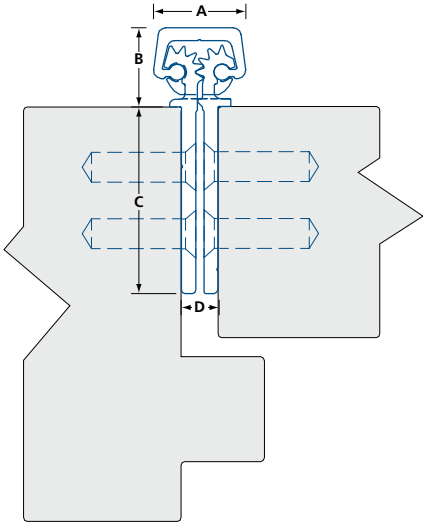

- Certified ANSI/BHMA A156.26, Grade 1
- cULus fire rated, 90/60 min.*
- Full mortise, heavy duty
- No door inset, flush mount
- 48" (1219 mm) door width maximum
- 450 lbs (204 kg) door weight maximum
- Undercut Tek screws included
- Power transfer ready model available (PT)
- 1000 lbs (454 kg) high capacity model available for lead lined doors

*Metal door / wood door

Available in a variety of finishes, models, options, and lengths. Please contact us to order. Visit www.abhmfg.com for product or warranty details (coverage may vary by country).

STANDARD LENGTHS

Inch: 79 / 83 / 85 / 95 / 120
MM: 2006 / 2108 / 2159 / 2413 / 3048

FINISHES

B-Black anodized
C-Clear anodized
D-Dark bronze anodized

ABH-A110	HD	C	095	-PT
MODEL	TYPE	FINISH	LENGTH	OPTION
HD: HEAVY DUTY LL: HIGH CAPACITY PT: POWER TRANSFER				

MODEL	A	B	C	D	E	CAPACITY ¹
ABH-A110HD	$\frac{25}{32}$ (19.8)	$\frac{21}{32}$ (16.7)	$\frac{19}{16}$ (39.7)	$\frac{5}{16}$ (7.9)	—	450 (204)

IN(MM) (1) LBS (KG) - HIGH CAPACITY MODEL AVAILABLE

ABH HALF SURFACE ALUMINUM GEARED HINGES

ABH-A530HD

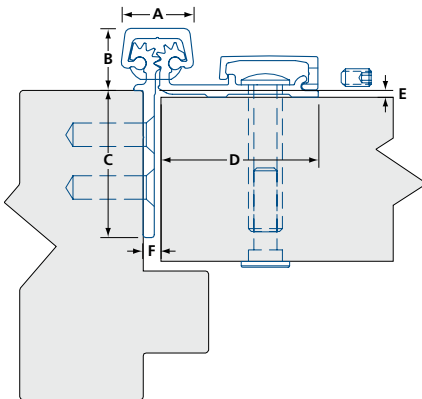

- Certified ANSI/BHMA A156.26, Grade 1
- cULus fire rated, 90/60 min.*
- Half surface, heavy duty
- $\frac{3}{32}$ " (2.4 mm) door inset
- 48" (1219 mm) door width maximum
- 450 lbs (204 kg) door weight maximum
- Undercut Tek screws and sex-nut bolts included

*Metal door / wood door

Available in a variety of finishes, models, options, and lengths. Please contact us to order. Visit www.abhmfg.com for product or warranty details (coverage may vary by country).

STANDARD LENGTHS

Inch: 79 / 83 / 85 / 95 / 120
MM: 2006 / 2108 / 2159 / 2413 / 3048

FINISHES

B-Black anodized
C-Clear anodized
D-Dark bronze anodized

ABH-A530	HD	C	083
MODEL	TYPE	FINISH	LENGTH
HD: HEAVY DUTY LL: HIGH CAPACITY PT: POWER TRANSFER			

MODEL	A	B	C	D	E ¹	F	CAPACITY ²
ABH-A530HD	$\frac{25}{32}$ (19.8)	$\frac{11}{16}$ (17.5)	$\frac{19}{16}$ (39.7)	$\frac{11}{16}$ (42.9)	$\frac{3}{32}$ (2.4)	$\frac{13}{64}$ (5.1)	450 (204)

IN(MM) (1) DOOR INSET (2) LBS (KG)

CONTINUOUS GEARED HINGES

FULL SURFACE

ABH FULL SURFACE ALUMINUM GEARED HINGES (SWING CLEAR)

ABH-A210HD

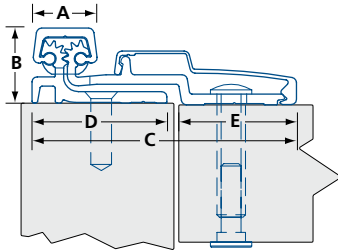

- Certified ANSI/BHMA A156.26, Grade 1
- cULus fire rated, 90/60 min.*
- Full surface, heavy duty
- Swing clear application
- No door inset, flush mount
- 48" (1219mm) door width maximum
- 450 lbs (204 kg) door weight maximum
- Undercut Tek screws and sex-nut bolts included

STANDARD LENGTHS

Inch: 79 / 83 / 85 / 95 / 120
MM: 2006 / 2108 / 2159 / 2413 / 3048

FINISHES

B–Black anodized
C–Clear anodized
D–Dark bronze anodized

*Metal door / wood door

Available in a variety of finishes, models, options, and lengths. Please contact us to order. Visit www.abhmfg.com for product or warranty details (coverage may vary by country).

ABH-A210	HD	C	083
MODEL	TYPE	FINISH	LENGTH

MODEL	A	B	C	D	E	CAPACITY ¹
ABH-A210HD	$\frac{25}{32}$ (19.8)	$\frac{29}{32}$ (23)	$3 \frac{5}{32}$ (80.6)	$1 \frac{5}{8}$ (41.3)	$1 \frac{35}{64}$ (39.3)	450 (204)

(1) LBS (KG) OTHER HIGH CAPACITY MODELS AVAILABLE

ABH FULL SURFACE ALUMINUM GEARED HINGES - CENTER PIVOT

ABH-A570HD

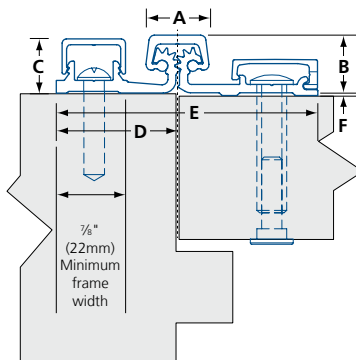

- Certified ANSI/BHMA A156.26, Grade 1
- cULus fire rated, 90/60 min.*
- Full surface, heavy duty
- For narrow-faced frames, $\frac{7}{8}$ " (22mm) minimum frame width
- $\frac{1}{16}$ " (1.6 mm) door inset
- 48" (1219 mm) door width maximum
- 450 lbs (204 kg) door weight maximum
- Undercut Tek screws and sex-nut bolts included

STANDARD LENGTHS

Inch: 79 / 83 / 85 / 95 / 120
MM: 2006 / 2108 / 2159 / 2413 / 3048

FINISHES

B–Black anodized
C–Clear anodized
D–Dark bronze anodized

*Metal door / wood door

Available in a variety of finishes, models, options, and lengths. Please contact us to order. Visit www.abhmfg.com for product or warranty details (coverage may vary by country).

ABH-A570	HD	C	083
MODEL	TYPE	FINISH	LENGTH

MODEL	A	B	C	D	E ¹	F	CAPACITY ²
ABH-A570HD	$\frac{23}{32}$ (18.3)	$\frac{23}{32}$ (18.3)	$2 \frac{1}{32}$ (16.7)	$1 \frac{15}{32}$ (37.3)	$3 \frac{3}{16}$ (81)	$\frac{1}{16}$ (1.6)	450 (204)

IN(MM) (1) DOOR INSET (2) LBS (KG)



CONTINUOUS GEARED HINGES

FULL CONCEALED

DOREX FULL CONCEALED ALUMINUM GEARED HINGE

CGHFM HD

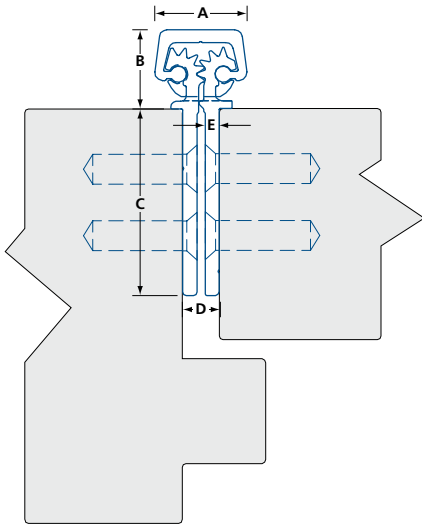

- Conforms to ANSI/BHMA A156.26 Grade 1
- 10 Year limited warranty
- Extruded 6063 aluminum alloy continuous geared hinges with self-lubricating thrust bearings
- Full concealed mounting (no mortise required), heavy duty
- No door inset, flush mount
- For doors 1 $\frac{3}{4}$ – 2 $\frac{1}{4}$ " (44.5 – 57 mm) thick, up to 48" (1219 mm) wide
- 400 lbs (182 kg) door weight maximum
- Doors heavier than 200 lbs (90.7 kg) require door and frame reinforcement
- Mounting hardware included for metal door and frame:
 - » #12-24x $\frac{5}{8}$ " (16 mm) self-drilling/tapping TEK screws (undercut)

STANDARD LENGTHS

Inch: 83 / 95 / 120
MM: 2108 / 2413 / 3048

FINISHES

AL–Aluminum anodized
DU–Dark bronze anodized
MB–Matte black anodized

CGH	FM	120	HD	-	AL
MODEL	TYPE	LENGTH	DUTY		FINSH
HD: HEAVY DUTY					

MODEL	A	B	C	D	E	CAPACITY
CGHFM HD	$\frac{25}{32}$ (20)	$\frac{3}{4}$ (19)	$1\frac{9}{16}$ (40)	$\frac{5}{16}$ (8)	$\frac{1}{8}$ (3)	400 (182)

IN(MM) LBS (KG)

CONTINUOUS GEARED HINGES

FULL SURFACE

DOREX® FULL SURFACE ALUMINUM GEARED HINGE (SWING CLEAR)

CGHFSSC HD

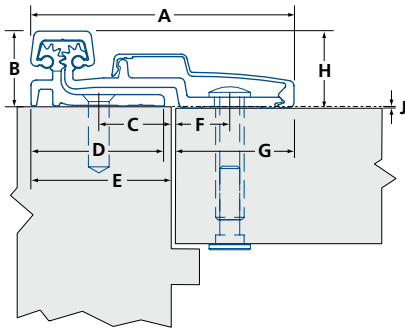

- Conforms to ANSI/BHMA A156.26 Grade 1
- 10 Year limited warranty
- Extruded 6063 aluminum alloy continuous geared hinges with self-lubricating thrust bearings
- Full surface, heavy duty
- Swing clear application
- 1/32" (0.8 mm) door inset
- For doors 1 3/4" – 2 1/4" (44.5 – 57 mm) thick, up to 48" (1219 mm) wide
- For door frames at least 1 3/4" (44 mm) wide when aligned with door gap
- 400 lbs (182 kg) door weight maximum
- Doors heavier than 200 lbs (90.7 kg) require door and frame reinforcement
- Mounting hardware included for metal door and frame:
 - » #12-24x5/8" (16 mm) self-drilling/tapping TEK screws (undercut)
 - » 1/4-20 Sex bolt and machine screws for doors up to 2 1/4" (57 mm) thick

STANDARD LENGTHS

Inch: 83 / 95 / 120
MM: 2108 / 2413 / 3048

FINISHES

AL–Aluminum anodized
DU–Dark bronze anodized
MB–Matte black anodized

CGH	FSSC	120	HD	–	AL
MODEL	TYPE	LENGTH	DUTY		FINISH

HD: HEAVY DUTY

MODEL	A	B	C	D	E	F	G	H	J'	CAPACITY ²
CGHFSSC HD	3.18 (81)	0.91 (23)	0.72 (18)	1.37 (35)	1.73 (44)	0.67 (17)	1.27 (32)	0.94 (24)	0.03 (0.8)	400 (182)

IN(MM) (1) DOOR INSET (2) LBS (KG)

DOREX® FULL SURFACE ALUMINUM GEARED HINGE (CENTER PIVOT)

CGHFSS HD

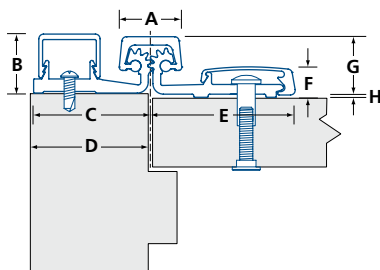

- Conforms to ANSI/BHMA A156.26 Grade 1
- 10 Year limited warranty
- Extruded 6063 aluminum alloy continuous geared hinges with self-lubricating thrust bearings
- Full surface, heavy duty
- 1/16" (1.6 mm) door inset
- For doors 1 3/4" – 2 1/4" (44.5 – 57 mm) thick, up to 48" (1219 mm) wide
- For narrow-faced door frames at least 1 1/2" (38 mm) when aligned with door gap; 7/8" (22 mm) when offset
- 400 lbs (182 kg) door weight maximum
- Doors heavier than 200 lbs (90.7 kg) require door and frame reinforcement
- Mounting hardware included for metal door and frame:
 - » #12-24x5/8" self-drilling/tapping TEK screws (undercut)
 - » 1/4-20 Sex bolt and machine screws for doors up to 2 1/4" (57 mm) thick

STANDARD LENGTHS

Inch: 83 / 95 / 120
MM: 2108 / 2413 / 3048

FINISHES

AL–Aluminum anodized
DU–Dark bronze anodized
MB–Matte black anodized

CGH	FS	120	HD	–	AL
MODEL	TYPE	LENGTH	DUTY		FINISH

HD: HEAVY DUTY

MODEL	A	B	C	D	E	F	G	H'	CAPACITY ²
CGHFSS HD	25/32 (20)	3/4 (19)	1 15/32 (37)	1 1/2 (38)	1 7/8 (48)	3/8 (9.5)	3/4 (19)	1/16 (1.6)	400 (182)

IN(MM) (1) DOOR INSET (2) LBS (KG)



PIVOTS

OFFSET

DOREX J SERIES 3/4" OFFSET PIVOT SETS

J25, J26, J28, J31

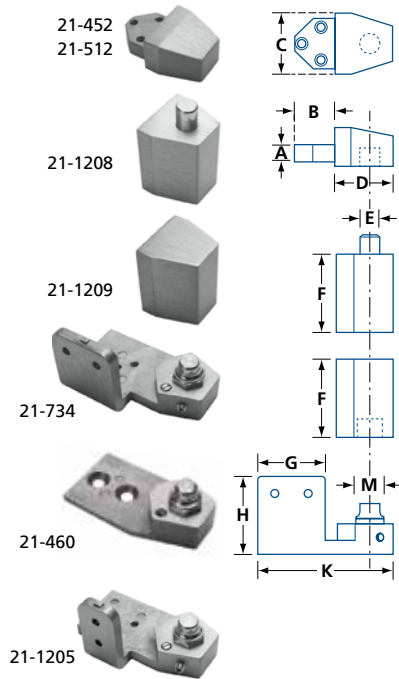

- For aluminum door and frame
 - Handed or non-handed – see chart
 - Capacity up to 125 lbs (57 kg)
 - 1/8" (3 mm) vertical adjustment range
 - Aluminum die-cast housing
 - All-weather acrylic coating
 - Oilite bronze bushing in frame top unit
 - Spring loaded pivot in door top unit
 - Full race ball bearing in door bottom unit
 - Case-hardened steel stub in frame bottom unit
- Modular design, all set components available individually – see chart

J2501	AL
SET	FINISH

J25 / J26 / J28 / J31

TYPE	SET	HAND	FINISH	FRAME TOP	DOOR TOP	DOOR BOTTOM	FRAME BOTTOM
Flush, jamb mount	J2501	RIGHT	AL	21-452	21-1208	21-1209	21-734
	J2502	LEFT	AL				21-738
1/8" Recess, jamb mount	J2601	RIGHT	AL	21-512	21-1208	21-1209	21-734
	J2602	LEFT	AL				21-738
1/8" Recess, non-handed	J2800	—	AL	21-512	21-1208	21-1209	21-460
1/8" Recess, narrow	J3101	RIGHT	AL	21-512	21-1208	21-1209	21-1205
	J3202	LEFT	AL				21-1204

	A	B	C	D	E	F	G	H	K	M
J25	13/32 (10)	29/32 (23)	1 3/8 (34.8)	1 9/32 (32.4)	7/16 (11)	1 3/4 (44.4)	1 1/2 (38.1)	1 3/4 (44.3)	3 1/32 (77)	1 1/16 (17.2)
J26	13/32 (10)	29/32 (23)	1 3/8 (34.8)	1 9/32 (32.4)	7/16 (11)	1 3/4 (44.4)	1 1/2 (38.1)	1 3/4 (44.3)	3 1/32 (77)	1 1/16 (17.2)
J28	13/32 (10)	29/32 (23)	1 3/8 (34.8)	1 9/32 (32.4)	7/16 (11)	1 3/4 (44.4)	—	—	3 1/32 (77)	1 1/16 (17.2)
J31/32	13/32 (10)	29/32 (23)	1 3/8 (34.8)	1 9/32 (32.4)	7/16 (11)	1 3/4 (44.4)	7/8 (22.2)	1 3/4 (44.3)	3 1/32 (77)	1 1/16 (17.2)

IN(MM)

PIVOTS

OFFSET

ABH 3/4" OFFSET PIVOT SET – JAMB MOUNT

ABH-0117.25



0180

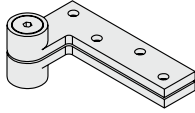

0117.25

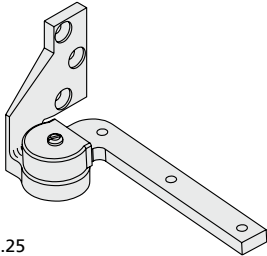

- Handed - indicate handing
- Maximum door width 42" (1066 mm) - interior doors only
- Maximum door load 250 lbs (113 kg)
- UL listed for use on 3-hour fire rated doors
- Conforms to ANSI C07162/3530A (modified)
- Heavy duty bearings
- Stainless steel base material
- Top pivot (#0180), header mount
- Bottom pivot (#0117.25), jamb mount
- Extended spindles available (special order)
- Use with ABH-019 intermediate pivot

Available in a variety of finishes, models, and options. Please contact us to order.
Visit www.abhmfg.com for product or warranty details (coverage may vary by country).

ABH-0117.25	-32D	-RH
MODEL	FINISH	HAND

LH : LEFT HAND RH : RIGHT HAND

ABH 3/4" OFFSET PIVOT SET

ABH-0147



0180

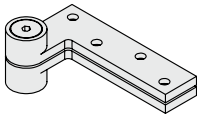

0147

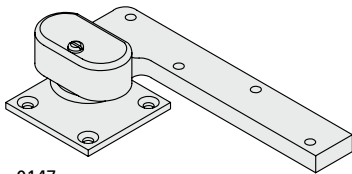

- Handed - indicate handing
- Maximum door load 600 lbs (272 kg)
- Maximum door width 48" (1219 mm); 36" (914 mm) for exterior doors
- UL listed for use on 3-hour fire rated doors
- Conforms to ANSI C07162/3530A (modified)
- Heavy duty bearings
- Stainless steel base material
- Top pivot (#0180), header mount
- Bottom pivot (#0147), floor mount
- Use with ABH-019 intermediate pivot

Available in a variety of finishes, models, and options. Please contact us to order.
Visit www.abhmfg.com for product or warranty details (coverage may vary by country).

ABH-0147	-32D	-RH
MODEL	FINISH	HAND

LH : LEFT HAND RH : RIGHT HAND



ABH CENTER HUNG PIVOT SET – JAMB MOUNT

ABH-0127

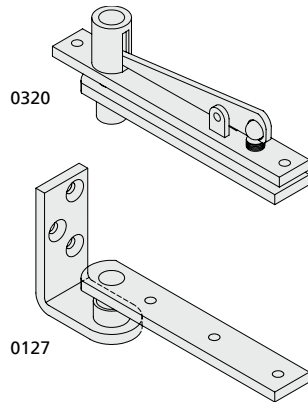

- Non handed
- Maximum door load 200 lbs (91 kg)
- Maximum door size 42 x 102" (1066 x 2591 mm) – interior doors only
- Conforms to ANSI C071042
- Heavy duty bearings
- Stainless steel base material
- Light duty top pivot (#0320), header mount
- Bottom pivot (#0127), jamb mount
- Extended spindles available (special order)
- Can be used with ABH Rescue Stops – please contact

Available in a variety of finishes, models, and options. Please contact us to order.
Visit www.abhmfg.com for product or warranty details (coverage may vary by country).

ABH-0127	- 32D
MODEL	FINISH

ABH CENTER HUNG PIVOT SET

ABH-0128

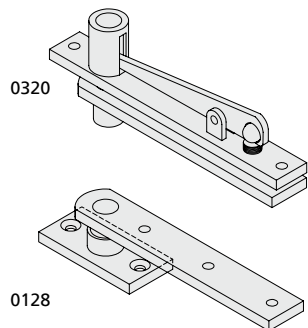

- Non-handed
- Maximum door load 250 lbs (113 kg)
- Maximum door size 42 x 102" (1066 x 2591 mm) – interior doors only
- Conforms to ANSI C07032/3530 (modified)
- Heavy duty bearings
- Stainless steel base material
- Light duty top pivot (#0320), header mount
- Bottom pivot (#0128), floor mount
- Extended spindles available (special order)
- Available with ABH CR4550 Rescue Strike – please contact

Available in a variety of finishes, models, and options. Please contact us to order.
Visit www.abhmfg.com for product or warranty details (coverage may vary by country).

ABH-0128	- 32D
MODEL	FINISH

PIVOTS

CENTER HUNG

ABH CENTER HUNG PIVOT SET – HEAVY DUTY

ABH-0370

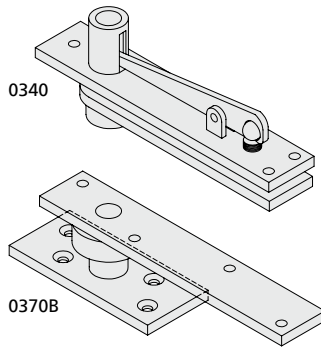

- Non-handed
- Maximum door load 500lbs (227kg)
- Maximum door size 44 x 102" (1118 x 2591 mm) – interior doors only
- Conforms to ANSI C07032
- Heavy duty bearings
- Stainless steel base material
- Heavy duty top pivot (#0340), header mount
- Bottom pivot (#0370B), floor mount
- Extended spindles available (special order)
- Top and bottom pivots available individually

Available in a variety of finishes, models, and options. Please contact us to order. Visit www.abhmfg.com for product or warranty details (coverage may vary by country).

ABH-0370	-32D
MODEL	FINISH

ABH REINFORCEMENT PIVOT – 3/4" OFFSET

ABH-0923

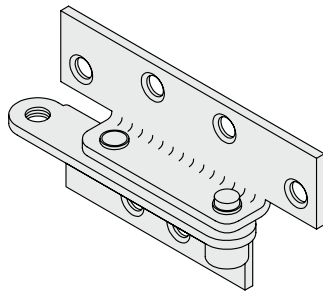

- Helps take load off failing top hinge and eliminate door sagging
- Surface mounts to the frame header and door face
- For 1/8" (3 mm) inset door with 3/4" (19 mm) offset
- Non-handed
- Maximum door load 300lbs (137 kg)
- Steel base material

Available in a variety of finishes, models, and options. Please contact us to order. Visit www.abhmfg.com for product or warranty details (coverage may vary by country).

ABH-0923	-32D
MODEL	FINISH

ABH INTERMEDIATE PIVOT – 3/4" OFFSET

ABH-019

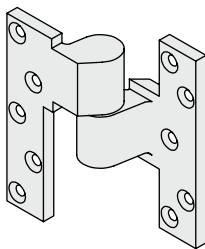

- Doors ranging from 60" tall should use one intermediate pivot. An additional intermediate pivot should be used for each additional 30" in door height. (ie, 90" tall door should use two intermediate pivots)
- Mortises into side jamb and hinge edge of door
- Handed
- For use with 3/4" (19 mm) offset pivot sets
- UL listed for use on 3-hour fire rated doors
- Helps maintain door alignment
- Heavy duty stainless steel needle bearings
- Stainless steel base material

Available in a variety of finishes, models, and options. Please contact us to order. Visit www.abhmfg.com for product or warranty details (coverage may vary by country).

ABH-019	LH	-32D
MODEL	HAND	FINISH

LH: LEFT HAND RH: RIGHT HAND



PIVOTS

SPRING & GRAVITY PIVOTS

7512P GRAVITY PIVOT



- Steel with nylon pivot bearing
- Non handed
- No spring, door self closing with door weight
- Double acting $\pm 90^\circ$, with $\frac{5}{8}$ " (16mm) door vertical rise
- Door thickness $\frac{7}{8}$ " to $1\frac{3}{4}$ " (22mm to 44mm)
- Maximum door width: 30" (762mm)
- Maximum door weight: 50 lbs (22.7kg)
- Surface mounted top & bottom door pivots
- Surface mounted mounting brackets
- Included #10 x 1" long mounting wood screws
- Zinc plated
- 7512P-H with hold-open feature

7512P	2G
MODEL	FINISH



7100 SERIES ADJUSTABLE SPRING PIVOTS



7112
Surface Pivot



7122
Mortise Pivot

- Non-handed
- For doors up to 36" (812mm) wide, $2\frac{1}{2}$ " (64mm) thick
- Maximum door weight: 75 lbs (34 kg)
- Cast steel with steel components
- Double acting
- Self-lubricating bearing
- Adjustable spring tension
- Flat door bracket for doors not less than 1" (25.4mm) thick
- Flat jamb bracket: $1\frac{1}{4}$ " (31.8mm) wide

7112	C2G
MODEL	FINISH

Available in a variety of architectural finishes, models and sizes – please contact to order or visit www.bommer.com for details

PIVOTS

SPRING & GRAVITY PIVOTS

7800 SERIES HORIZONTAL SPRING PIVOTS



- Non handed
- Light, medium and heavy duty models available
- Double acting
- Anti-friction bearing
- Maximum door width: 36" (914mm)
- Door thickness: 1 $\frac{3}{8}$ –1 $\frac{3}{4}$ " (35–44.5 mm)
- Hold open models available
- Top pivot and plate included

7801-C26D
SATIN CHROME

Light (35 lbs/16 kg)
Floor Mounted
Hold Open at 85°

7811P-H-19
MATTE BLACK

7811P-H-32D
SATIN STAINLESS STEEL

Medium (77 lbs/35 kg)
Floor Mounted
Hold Open at
88° and 116°

7813HD-C2G
ZINC PLATED

Heavy (150 lbs/68 kg)
Floor Mounted
No Hold Open

7811P-H - 32D	
MODEL	FINISH



PATCH FITTINGS

GLASS DOOR & PANELS

PF120 TOP DOOR PATCH FITTING

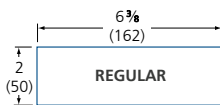

PF120TP1
Top Pivot



PF120TP2
Walking Pivot

- Recommended for use with top pivot #PF120TP1 or walking pivot #PF120TP2
- Also recommended for use with corner patch fitting #PF140 or wall mounted patch fitting #PF130
- Capacity: 220 lbs (100 kg)

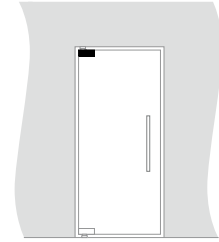

Maximum Door Size:
39 x 108 in (100 x 274 cm)

PF120	-	630
MODEL		FINISH

628	629	630	19
ALUMINUM	POLISHED STAINLESS STEEL	SATIN STAINLESS STEEL	MATTE BLACK

PF121 TOP DOOR PATCH FITTING – EXTENDED COVER

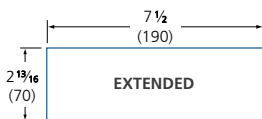

PF120TP1
Top Pivot



PF120TP2
Walking Pivot

- Recommended for use with #PF120TP1 top pivot or #PF120TP2 walking pivot
- Extended cover used to match #PF100DC/DCHO hydraulic patch fitting closer (see page 03.060)
- Capacity: 220 lbs (100 kg)

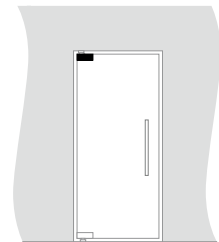

Maximum Door Size:
39 x 108 in (100 x 274 cm)

PF121	-	630
MODEL		FINISH

628	629	630	19
ALUMINUM	POLISHED STAINLESS STEEL	SATIN STAINLESS STEEL	MATTE BLACK

PATCH FITTINGS

GLASS DOOR & PANELS

PF150 TOP DOOR PATCH FITTING

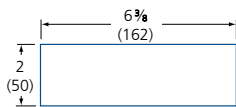

DOREX 30 Series
Door Closer

- Recommended for use with DOREX 30 concealed overhead door closer (see page 03.052)
- Capacity: 220 lbs (100 kg)

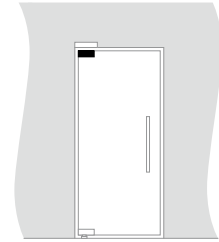

Maximum Door Size:
39 x 108 in (100 x 274 cm)

PF150	-	630
MODEL		FINISH

628	629	630	19*
ALUMINUM	POLISHED STAINLESS STEEL	SATIN STAINLESS STEEL	MATTE BLACK

(*) SPECIAL ORDER

PF110 BOTTOM DOOR PATCH FITTING

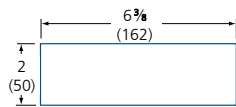

DOREX 40 Series
Door Closer



PF110BP1
Bottom Door Pivot

- Recommended for use with #PF110BP1 bottom door pivot or with DOREX 40 Series concealed floor closer (see page 03.054)
- Capacity: 220 lbs (100 kg)

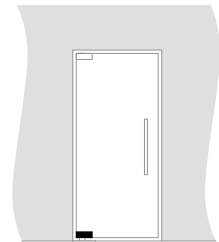

Maximum Door Size:
39 x 108 in (100 x 274 cm)

PF110	-	630
MODEL		FINISH

628	629	630	19*
ALUMINUM	POLISHED STAINLESS STEEL	SATIN STAINLESS STEEL	MATTE BLACK

(*) SPECIAL ORDER



PATCH FITTINGS

GLASS DOORS AND PANELS

PF160 TRANSOM CORNER PATCH FITTING WITH DOOR STOP



- For use with glass transom and sidelight
- For single glass door applications
- Capacity: 220 lbs (100 kg)

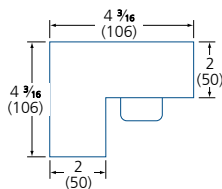
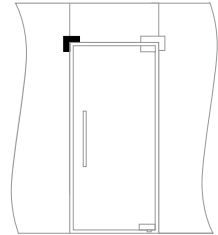

PF160	–	630
MODEL		FINISH

628	629	630	19*
ALUMINUM	POLISHED STAINLESS STEEL	SATIN STAINLESS STEEL	MATTE BLACK

(*) SPECIAL ORDER

PF165 TRANSOM CONNECTOR WITH DOOR STOP



- For use with glass transom
- For double glass door applications
- Capacity: 220 lbs (100 kg)

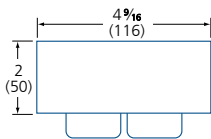
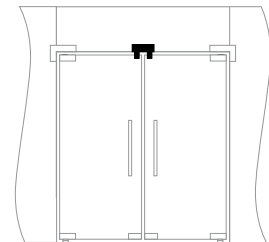

PF165	–	630
MODEL		FINISH

628	629	630	19*
ALUMINUM	POLISHED STAINLESS STEEL	SATIN STAINLESS STEEL	MATTE BLACK

(*) SPECIAL ORDER

PF165CM CEILING MOUNTED DOOR STOP



- Installed on ceiling or solid transom
- For single or double glass door applications
- Cast stainless steel
- Includes mounting screws and plastic anchors

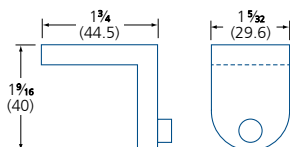
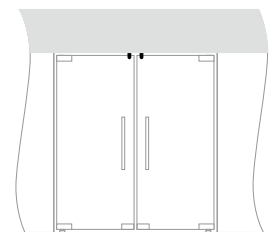

PF165CM	–	630
MODEL		FINISH

PATCH FITTINGS

GLASS DOOR & PANELS

PF140 TRANSOM CORNER PATCH FITTING WITH PIVOT



- For use with glass transom and sidelight
- Recommended for use with top door patch fitting #PF120
- Capacity: 220 lbs (100 kg)

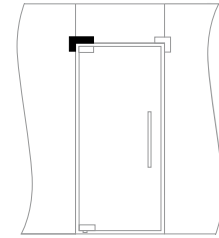

Maximum Door Size:
39 x 108 in (100 x 274 cm)

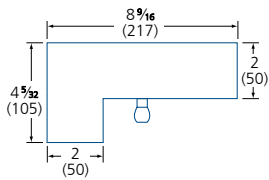

PF120
Top Door Patch Fitting

PF140	-	630
MODEL		FINISH

628	629	630	19
ALUMINUM	POLISHED STAINLESS STEEL	SATIN STAINLESS STEEL	MATTE BLACK



PATCH FITTINGS

GLASS DOORS AND PANELS

PF130 WALL MOUNT TRANSOM PATCH FITTING WITH PIVOT

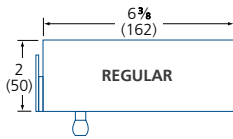

PF120
Top Door Patch Fitting

- For wall mounted installation with glass transom
- Recommended for use with top door patch fitting #PF120
- Includes machine screws and anchors
- Capacity: 220 lbs (100 kg)

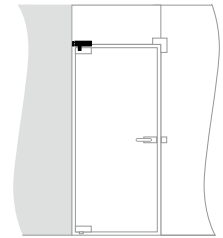

Maximum Door Size:
39 x 108 in (100 x 274 cm)

PF130	-	630
MODEL		FINISH

628	629	630	19*
ALUMINUM	POLISHED STAINLESS STEEL	SATIN STAINLESS STEEL	MATTE BLACK

(*) SPECIAL ORDER

PF131 WALL MOUNT TRANSOM PATCH FITTING WITH PIVOT - EXTENDED COVER

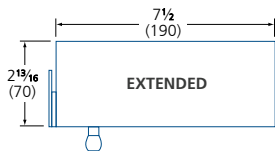

PF100DC / PF102DC
Door Closer



PF121
Top Door Patch Fitting

- For wall mounted installation with glass transom
- Recommended for use with #PF100DC or #PF102DC door closers (see page 03.060 or 03.062) and top door patch fitting #PF121
- Includes machine screws and anchors
- Capacity: 220 lbs (100 kg)

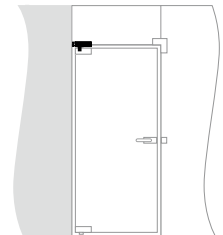

Maximum Door Size:
39 x 108 in (100 x 274 cm)

PF131	-	630
MODEL		FINISH

628	629	630	19*
ALUMINUM	POLISHED STAINLESS STEEL	SATIN STAINLESS STEEL	MATTE BLACK

(*) SPECIAL ORDER

PATCH FITTINGS

GLASS DOOR & PANELS

PF163 WALL MOUNT TRANSOM PATCH FITTING WITH DOOR STOP

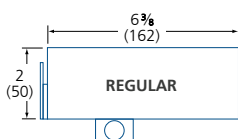

- For wall mounted installation with glass transom
- Includes regular machine screws and anchors
- Capacity: 220 lbs (100 kg)

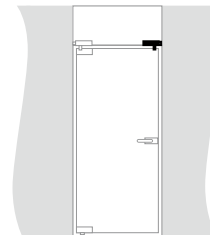

PF163	-	630
MODEL		FINISH

628	629	630	19*
ALUMINUM	POLISHED STAINLESS STEEL	SATIN STAINLESS STEEL	MATTE BLACK

(*)SPECIAL ORDER

PF164 WALL MOUNT TRANSOM PATCH FITTING WITH DOOR STOP – EXTENDED COVER

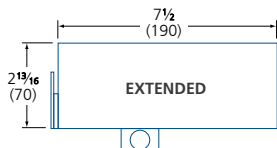

- For wall mounted installation with glass transom
- Recommended for use with #PF100DC or #PF102DC door closers (see page 03.060 or 03.062) and top door patch fitting #PF121
- Includes regular machine screws and anchors
- Capacity: 220 lbs (100 kg)

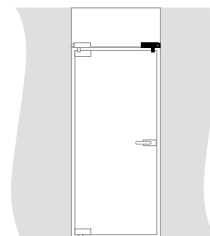

PF164	-	630
MODEL		FINISH

628	629	630	19*
ALUMINUM	POLISHED STAINLESS STEEL	SATIN STAINLESS STEEL	MATTE BLACK

(*)SPECIAL ORDER



PF100DC / PF102DC
Door Closer



PF121
Top Door Patch Fitting



ASSORTED HINGES

STRAP, TEE & BACK FLAP HINGES

STRAP HINGE

1209



- Heavy duty steel hinge, fixed pin
- Counter-sunk holes
- Screws not included

1209	ZP	4
MODEL	FINISH	SIZE

MODEL	HINGE SIZE (LxW)		FINISH	HOLES	SCREWS NOT INCLUDED	QTY ¹
	INCHES	MM				
1209 4	3 1/2 x 4	88.9 x 88.9	ZP	6	#8	2/10
1209 6	4 x 6	101.6 x 101.6	ZP	6	#8	2/10

(1) 2/10 : QUANTITY PER BOX / PAIRS PER CASE. HINGES NOT SOLD INDIVIDUALLY.
ZP-ZINC PLATED

TEE HINGE

1609

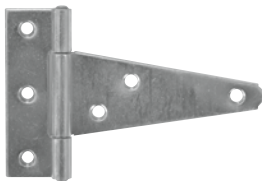

- Heavy duty steel hinge, fixed pin
- Counter-sunk holes
- Screws not included

1609	ZP	4
MODEL	FINISH	SIZE

MODEL	HINGE SIZE (LxW)		FINISH	HOLES	SCREWS NOT INCLUDED	QTY ¹
	INCHES	MM				
1609 4	3 3/8 x 4	86 x 107	ZP	6	#8	2/10
1609 6	4 1/2 x 6	113 x 153	ZP	6	#8	2/5

(1) 2/10 : QUANTITY PER BOX / PAIRS PER CASE. HINGES NOT SOLD INDIVIDUALLY.
ZP-ZINC PLATED

BACK FLAP HINGE

1002, 4002, 4012

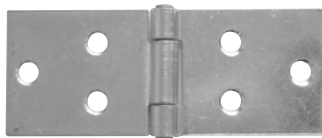

1002-114
Fixed pin

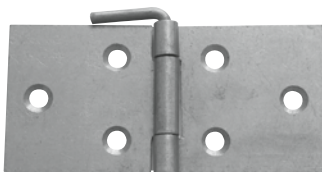

4012
Bent loose pin

- Steel hinge, fixed or bent loose pin
- Counter-sunk holes
- Screws not included

1002-114
MODEL

MODEL	HINGE SIZE (LxW)		FINISH	HOLES	SCREWS NOT INCLUDED	QTY ¹
	INCHES	MM				
1002-114	1 1/4 x 3 1/4	32 x 83	ZP	6	#6	2/10
1002-112	1 1/2 x 3 1/2	38 x 89	ZP	6	#7	2/10
1002-2	2 x 4 1/2	51 x 114	ZP	6	#8	2/10
4002	2 x 4 1/4	51 x 107	PS	6	#8	2/10
4012	2 x 4 1/4	51 x 107	PS	6	#8	2/10

(1) 2/10 : QUANTITY PER BOX / PAIRS PER CASE. HINGES NOT SOLD INDIVIDUALLY.
ZP-ZINC PLATED; PS-PLAIN STEEL

ASSORTED HINGES

MISCELLANEOUS HINGES

3-LEAF PANEL HINGES

130



130, 130A,
130ST

130L

- For light weight panels
- 3½x2¼" (89x57 mm) steel hinge
- Fixed or loose pin
- Nylon bearings
- Screws NOT included

OPTIONS

- A: Lose pin, assembled
- L: Extended 2½" (64mm) center leaf
- ST: Steeple tip

FINISH

- C15: Satin nickel
- C2G: Zinc plated
- C4: Satin brass

130	ST	C4
MODEL	OPTION	FINISH

AVAILABLE 50 PAIRS / BOX

GRAVITY PIVOT HINGE – LIGHT DUTY

3000



- For ¾" (19 mm) or thicker light weight panels
- Steel with nylon bearings
- Adjustable panel plum
- Hold open at 110°
- Brass plated

3000
MODEL

AVAILABLE 10 PAIRS / BOX

LIFT-HINGE

4570



- Light duty
- 3x2¼" (76x57 mm) steel hinge
- Handed
- Swagged
- Unfinished plain steel
- Screws NOT included

4570	L
MODEL	HAND

L-LEFT; R-RIGHT AVAILABLE 10 PAIRS / BOX



ASSORTED HINGES

CONTINUOUS HINGE

CONTINUOUS HINGES

1116, 114, 112, 2, 3



- Steel hinge with steel pin
- Only available in 72" (1829mm) lengths
- Screws are not included
- Stainless steel models available—see chart
- Aluminum models available—see chart

OPTIONS

NH: No Holes

2AL	NH
MODEL	OPTION
PLEASE CONTACT FOR OPTION/FINISH AVAILABILITY	

MODEL	MATERIAL	SIZE OPEN WIDTH	HOLE SPACING	KNUCKLE WIDTH	SCREWS NOT INCLUDED	QTY ¹
3PS	Steel	3 (76)	2 (50.8)	½ (12.7)	N/A*	100
1116ST		1⅞ (27)			#5	100
114ST		1¼ (32)			#5	100
112ST	Stainless steel	1½ (38)	2 (50.8)	½ (12.7)	#6	50
2ST		2 (51)			#6	50
3ST		3 (76)			N/A*	50
112AL	Aluminum	1½ (38)	2	½	#6	100
2AL		2 (51)	(50.8)	(12.7)	#6	50

IN (MM) (*) ONLY AVAILABLE WITHOUT HOLES (1) QUANTITY PER CASE

SPECIALTY HINGES

INVISIBLE HINGES

SOSS INVISIBLE HINGES

SOSS



S220
5½" (140mm)

- For wood or metal applications
- Models can accommodate cabinet to full-sized doors
- Hinge cannot be seen or tampered with when closed
- Zinc body with steel pins
- Opens 180°
- Smooth operation
- All hinges include wood screws; machine screws available (please specify)
- Fire rated (UL Listed) models up to 180 minutes available
- Power Transfer models available
- Extreme weight or size models available
- Surface mounted models for metal cabinets available
- Steel door reinforcement plates available



S220PT
5½" (140mm)
Power Transfer



S106
2¾" (60mm)
Rear-mount

Available in a wide variety of finishes, models, sizes, and options. Please contact us to order. Visit www.soss.com for product or warranty details.

S220	FR	C26D
MODEL	OPTION	FINISH

PLEASE CONTACT TO ORDER

SOSS INVISIBLE SPRING HINGE CLOSER

SOSS

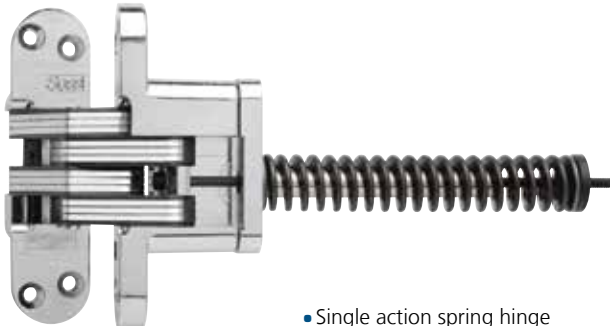

- Single action spring hinge
- For solid wood or hollow core doors 1¾–2" (35–51 mm) thick
- Maximum opening: 180°
- Hinge cannot be seen or tampered with when closed
- Adjustable closing speed after installation by hex key
- Can be installed inside door or jamb
- Recommend one spring hinge for every 20" (508 mm) height or every 55 lbs (25 kg)
- Supporting invisible hinges are required
- Fire rated (UL Listed) models up to 180 minutes available

Available in a wide variety of finishes, models, sizes, and options. Please contact us to order. Visit www.soss.com for product or warranty details.

S220IC	C26D
MODEL	FINISH

PLEASE CONTACT TO ORDER

SPECIALTY HINGES

INVISIBLE HINGES

SOSS INVISIBLE BARREL HINGES

SOSS



- Not recommended for vertical or load bearing applications - light applications only
- Hinge cannot be seen or tampered with when closed
- Easy press-fit installation; additional screw can be used to additional strength on some sizes
- Solid brass
- Opens to 180°

Available in a wide variety of finishes, models, sizes, and options. Please contact us to order. Visit www.soss.com for product or warranty details.

SBH124	C4
MODEL	FINISH

PLEASE CONTACT TO ORDER



SPECIALTY HINGES

POWER TRANSFER

ABH POWER TRANSFER – PRE-WIRED

ABH-PT200, ABH-PT1000



- Allows transferring electrical power & data from the frame to the door in a secure and discreet manner.
- Unit mortises into the edges of the door and frame and is completely concealed when the door is in the closed position.
- All metal construction including backboxes - NO PLASTIC PARTS
- Ideal for high abuse or heavy traffic situations
- UL/ULC Listed for use on fire doors
- For doors at least 1 $\frac{3}{4}$ " (45mm) thick
- Maximum door opening: 180°
- Not for use with swing clear hinges, pocket pivots, butt hinges larger than 6" (152 mm), 1 $\frac{1}{2}$ " (38mm) offset pivots or center hung doors
- ABH-PT200: (2) 18 AWG Wires (Max. 24VDC, 5A or 120VAC NEC Class 3), Max. Surge (In-Rush): 16A
- ABH-PT1000: (10) 24 AWG Wires (MAX. 24VDC, 1A)

Available in a wide variety of finishes and options
– please contact to order or visit www.abhmfg.com for details

ABH-PT200	–	28
MODEL		FINISH

PLEASE CONTACT TO ORDER

ABH POWER TRANSFER

ABH-PT105, AB-PT180



- Models provide housing for running wires from the frame to the door in a secure and discreet manner
- Stainless steel housing and spring conduit
- Spring conduit fits wire bundles up to $\frac{5}{16}$ " (8mm) thick
- Works with most butt hinges, continuous hinges and $\frac{3}{4}$ " (19mm) offset pivots
- Maximum door opening
 - » ABH-PT105: 105°
 - » ABH-PT180: 180°
- Available with square or round corners

Available in a wide variety of finishes and options
– please contact to order or visit www.abhmfg.com for details

ABH-PT105	–	32D
MODEL		FINISH

PLEASE CONTACT TO ORDER

SPECIALTY HINGES

POWER TRANSFER

DOOR LOOP

SDL-20



- A door loop is a simple method of transferring low voltage power from the door frame to the locking device
- Commonly used with electric mortise and cylindrical locks, electric exit trims and latch pullback devices.
- Surface mounted
- Non-wired
- Field sizeable flexible armoured conduit
- Minimum conduit length included: 20" (508mm)
- Maximum electrical wires: 7 ea. 18 awg, 10 ea. 22 awg
- Pre-drilled mounting holes
- Available in aluminum finish (AL)
- Dark bronze finish available by special order

SDL-20	AL
MODEL	FINISH

AL: ALUMINUM

DOOR LOOP – CONCEALED

CDL



- A door loop is a simple method of transferring low voltage power from the door frame to the locking device
- Unlike surface door loops, the armoured conduit slides into the door and/or door frame.
- For continuous or butt hinge, full mortise, half mortise or half surface applications
- Supports up to 180° openings
- Concealed mounting
- Non-wired
- Flexible 6" (152.4 mm) armoured conduit, 1/4" (6.4 mm) diameter
- Aluminum end-caps

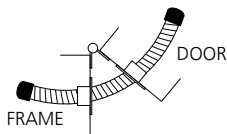
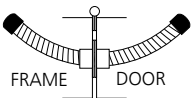

CDL	-	AL
MODEL		FINISH

AL: ALUMINUM



SPECIALTY HINGES

POWER TRANSFER

POWER TRANSFER HINGE

JC-603QC-BB1079

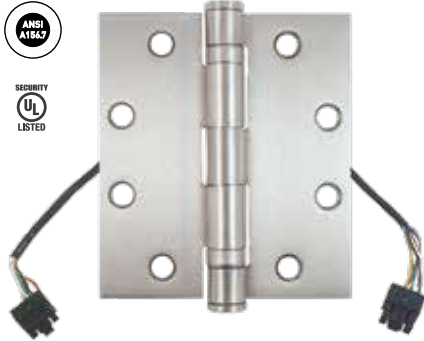

- Standard weight, full mortise
- 5 knuckles, 2 ball bearings
- Steel with non-removable steel pin
- ANSI/BHMA A156.7 template hole pattern
- UL Security Listed

OPTIONS

- ETW04: 4 Wires
- ETW08: 8 Wires

- For hollow door and frame
- 8 or 4 wire transfer with molex connector
- Wood and undercut machine screws included
- Must be installed with two other ball bearing hinges of the same size

JC-603QC0-BB1079	- 454	- 26D	- ETW08
MODEL	SIZE	FINISH	OPTION

SIZE	INCHES	MM	LEAF GAUGE	HOLES	SCREWS INCLUDED		QTY ¹
					MACHINE	WOOD	
454	4 1/2 x 4	114.3 x 101.6	0.134	8	#12-24 x 1/2	#12 x 1 1/4	1

(1) SOLD BY UNIT

WIRING DETAILS

- Wiring: 28 AWG stranded w/PTFE insulation, NEMA HP-3
- Maximum Amp: 4 amp continuous for wires up to 9in (228.6mm) @ 24v AC or DC
EX: 8 wires = 0.5amp / wire
- Maximum Surge (in-rush): 16amp pulse for 300msec / 10amp pulse for 250 msec.

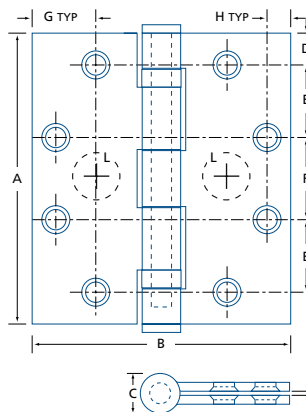

A	B	C	D	E	F	G	H	K	ø L*
4 1/2	4	19/32	1/2	1 1/8	1 15/64	1	3/8	1/16	19/32
(114.3)	(101.6)	(15.2)	(12.7)	(28.6)	(31)	(25.4)	(9.5)	(1.6)	(ø15)

DIMENSIONS IN INCHES (MILLIMETRES) AS PER ANSI A156.7
SEE INSTALLATION INSTRUCTIONS FOR DETAILS

*DIMENSION OF THE NODE, NOT FRAME PREPARATION.









TABLE OF CONTENTS SECURITY HARDWARE

Finish Guide.....	ii
Abbreviation Guide.....	iii
PADLOCKS & ACCESSORIES	
GUARD Padlocks.....	05.010
Padlocks	05.020
VIRO Padlocks.....	05.040
Specialty Padlocks.....	05.060
STOREFRONT HARDWARE	
DOREX Mortise Locks.....	05.200
VIRO Mortise Locks	05.210
Door Handles & Paddles.....	05.240
Electric Strikes.....	05.260
CYLINDERS	
Mortise Cylinders.....	05.400
Rim Cylinders.....	05.410
Cylinder Trim Rings.....	05.420
Guards & Latch Protectors.....	05.430
Profile Cylinders.....	05.440
DOOR SECURITY	
Door Viewers.....	05.600
Door Guards & Chains	05.610
Rim Locks	05.630
Door Protection	05.640
ASSORTED SMALL LOCKS	
Cam Locks.....	05.700
KEY ACCESSORIES	
Key Cabinets.....	05.800
Key Rings & Tags	05.810





R2026A10





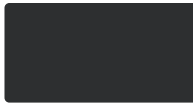

				
PRIME COATED	BLACK JAPANED / LACQ.	MATTE BLACK LACQUER	ZINC PLATED	YELLOW ZINC PLATED
CODE CP	C1B, KJ	C1D	C2G, ZP	C2GY, YZ
BHMA* 600	601	693	603	

				
POLISHED BRASS	MIRROR POLISHED BRASS	SATIN BRASS	ANTIQUE BRASS	SATIN BRONZE
CODE BP, BP032, C3, 3	C3M, 3M	C4, 4, SDB	AB, C5, 5	C10, 10
BHMA* 605, 632		606, 633	609, 638	612, 639

				
OIL RUBBED BRONZE	POLISHED NICKEL	SATIN NICKEL	ANTIQUÉ NICKEL	MATTE BLACK
CODE C10B, 10B	NP, C14, 14	SDN, SN, C15, 15	AN, C15A, 15A	C19, 19
BHMA* 613, 640	645	619, 646	620, 647	622, 631

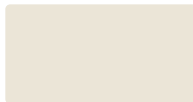
				
DARK BRONZE	POLISHED CHROME	SATIN CHROME	POLISHED STAINLESS STEEL	SATIN STAINLESS STEEL
CODE BLR, DU, C20D, 20D	CHR, C26, 26	SC, C26D, 26D	C32, 32	SS, ST, C32D, 32D
BHMA* 650, 690, 695	625, 651	626, 652	629	630

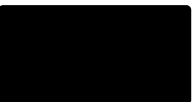
	
ALUMINUM	PLAIN STEEL, NO FINISH
CODE AL, C28, 28	PS
BHMA* 628, 689	

				
ALMOND WHITE	LIGHT BRONZE	EPOXY BLACK	EPOXY WHITE	SATIN WHITE
CODE ALMOND, AW	BZ	EXB	EXW	WSILK
BHMA*				

			
WHITE	BROWN	SILVER PAINT	GOLD PAINT
CODE WH, WHITE	B	SL	GD
BHMA*			

ALL FINISHES IMAGES ABOVE ARE PHOTOGRAPHIC OR COLOUR APPROXIMATIONS, DELIVERED PRODUCT MAY VARY IN COMPARISON OR BETWEEN ORDERS/LOTS.
OTHER FINISHES AVAILABLE—PLEASE CONTACT.
(*) EQUIVALENT; CODES DIFFER DEPENDING ON BASE MATERIAL AND/OR FINISH PROCESS.

SECURITY HARDWARE ABBREVIATION GUIDE

GENERAL

BS	Backset
DIA, Ø	Diameter
KG	Kilograms
LBS	Pounds
LH	Left hand
LHR	Left hand reversed
MAX	Maximum
MIN	Minimum
N/A, —	Not applicable / Not available
QTY	Quantity (usually followed by notes)
RH	Right hand
RHR	Right hand reversed
SQ, ▣	Square
WT	Weight
/UNIT	Number of items per basic unit of sale (bagged or boxed). The default is 1.
/BOX, /BAG	Number of UNITS found in an inner carton or bag.
/CASE	Number of UNITS found in an outer (shipping) carton.

CURRENT

AC	Alternating current
DC	Direct current
V	Volts, voltage
A	Amperes
Ω	Ohms

KEYING

CKD	Completely knocked down
KA	Keyed alike
KA2	Keyed alike in pairs
KD	Keyed different
MK	Master keyed
SA	Sub-assembled
UP	Unpinned

KEYWAY / CYLINDER TYPE

DM	Dummy
SC	Schlage C
WEI, WR	Weiser
T1	Thumbturn profile 1
Y9	Yale #9

LEGEND



Tested to Canadian and/or American safety and performance standards by Underwriters Laboratories® (UL).



Tested to Canadian and/or American safety and performance standards by Warnok Hersey/Intertek® (WH).



GUARD PADLOCKS

SECURITY HARDWARE

GUARD SOLID BRASS PADLOCKS

800 SERIES



- Solid brass body, sanded finish
- Hardened steel shackle, chrome plated
- Single or double locking shackle
- Long shackle (L) model available
- Stainless steel springs
- Pick resistant mushroom pins
- Brass cylinder with 2 keys

KEYING

- KA: Keyed alike
 - KD: Keyed different
 - KDC: Retail packaging (keyed different)
 - MK: Master keyed
 - UP: Unpinned
- Engraving – please contact

*Keying services available

835L	KA
MODEL	KEYING

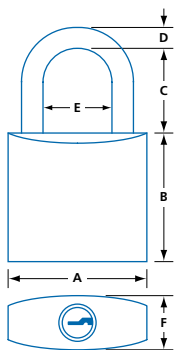

MODEL	SIZE	PINS	KEYING	BODY SIZE			SHACKLE SIZE			QTY ¹
				A	B	F	C	E	ø D	
SINGLE LOCKING										
831	20	3	KA, KD	¾ (19.4)	¾ (20.0)	⅝ (10.9)	½ (11.5)	⅜ (9.6)	⅛ (3.2)	12/576
832	25	4	KA, KD	1 (25.1)	1 (24.3)	½ (11.9)	½ (14.2)	½ (12.6)	⅛ (4.0)	12/324
DOUBLE LOCKING										
833	30	4	KA, KD, UP	1¼ (31.4)	1¼ (30.3)	½ (13.5)	¾ (19.6)	⅝ (16.7)	¼ (5.0)	12/216
834*	40	5	KA, KD, MK, UP	1½ (37.7)	1⅝ (36.5)	⅝ (15.2)	⅞ (22.5)	¾ (19.5)	¼ (6.4)	12/96
834L*	40	5	KA, KD, UP	1½ (37.7)	1⅝ (36.5)	⅝ (15.2)	2½ (63.0)	¾ (19.5)	¼ (6.4)	6/96
835	45	5	KA, KD, UP	1¾ (43.9)	1⅝ (41.4)	⅝ (17.0)	1 (26.5)	⅞ (22.5)	¼ (7.9)	6/72
835L	45	5	KA, KD	1¾ (43.9)	1⅝ (41.4)	⅝ (17.0)	2½ (63.0)	⅞ (22.5)	¼ (7.9)	6/72
836	50	5	KA, KD, MK, UP	2 (50.3)	1¾ (45.6)	¾ (18.5)	1⅝ (28.0)	1 (25.4)	⅜ (9.5)	6/72
836L	50	5	KA, KD	2 (50.3)	1¾ (45.6)	¾ (18.5)	2½ (63.0)	1 (25.4)	⅜ (9.5)	6/48

IN (MM) (1) 12/600 : UNITS PER BOX / UNITS PER CASE. (*) AVAILABLE WITH CORBIN (A), CISA (C) OR GUARD (V) REVERSE KEYWAYS
IMPERIAL MEASUREMENTS ARE FOR REFERENCE ONLY, ROUNDED TO NEAREST 1/16"

GUARD PADLOCKS

SECURITY HARDWARE

GUARD LAMINATED PADLOCKS

700 SERIES



- Laminated steel plate body
- Hardened steel shackle, chrome plated
- Single or double locking shackle
- Stainless steel springs
- Pick resistant mushroom pins
- Brass cylinder with 2 keys

KEYING

- KA: Keyed alike
- KD: Keyed different
- KDC: Retail packaging (keyed different)

*Keying services available

740	KD
MODEL	KEYING

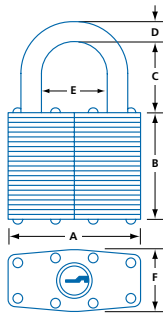

MODEL	SIZE	PINS	KEYING	BODY SIZE			SHACKLE SIZE			QTY ¹
				A	B	F	C	E	∅ D	
SINGLE LOCKING										
730	30	3	KA, KD	1 ³¹ / ₃₂ (50.0)	1 ⁹ / ₁₆ (40.0)	1 ¹¹ / ₁₆ (17.5)	1 ³ / ₃₂ (27.5)	1 ⁵ / ₃₂ (29.5)	1 ¹¹ / ₁₆ (17.5)	12/216
DOUBLE LOCKING										
740	40	5	KA, KD	2 ³ / ₈ (60.0)	1 ¹³ / ₁₆ (46.0)	7 ⁷ / ₈ (20.5)	1 ¹⁵ / ₃₂ (37.5)	1 ³ / ₈ (35.0)	7 ⁷ / ₈ (20.5)	12/96
744	45	5	KA, KD	1 ⁹ / ₁₆ (40.0)	1 ⁵ / ₁₆ (33.0)	2 ¹ / ₃₂ (16.5)	2 ⁹ / ₃₂ (23.0)	1 ⁵ / ₁₆ (24.0)	2 ¹ / ₃₂ (16.5)	12/96
750	50	5	KA, KD	1 ³¹ / ₃₂ (50.0)	1 ⁹ / ₁₆ (40.0)	1 ¹¹ / ₁₆ (17.5)	1 ³ / ₃₂ (27.5)	1 ⁵ / ₃₂ (29.5)	1 ¹¹ / ₁₆ (17.5)	6/72

IN (MM) (1) 12/216 : UNITS PER BOX / UNITS PER CASE. IMPERIAL MEASUREMENTS ARE FOR REFERENCE ONLY, ROUNDED TO NEAREST 1/8"

GUARD MARINE PADLOCKS – LONG SHACKLE

936L



- Solid brass body, chrome finish
- Stainless steel shackle
- Double locking long shackle
- Stainless steel springs
- Pick resistant mushroom pins
- Includes 2 keys

KEYING

- KA: Keyed alike
- KD: Keyed different

*Keying services available

963L	KD
MODEL	KEYING

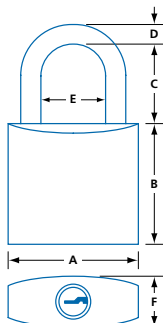

MODEL	SIZE	PINS	KEYING	BODY SIZE			SHACKLE SIZE			QTY ¹
				A	B	F	C	E	∅ D	
DOUBLE LOCKING										
936L	50	5	KD	2 (49.9)	1 ⁵ / ₈ (40.2)	5 ⁵ / ₈ (16.8)	3 ¹ / ₂ (88.0)	1 ¹ / ₈ (29.0)	1 ¹ / ₄ (7.9)	6/48

IN (MM) (1) 6/48 : UNITS PER BOX / UNITS PER CASE. IMPERIAL MEASUREMENTS ARE FOR REFERENCE ONLY, ROUNDED TO NEAREST 1/8"



GUARD PADLOCKS

SECURITY HARDWARE

GUARD[®] PADLOCK KEYING PARTS

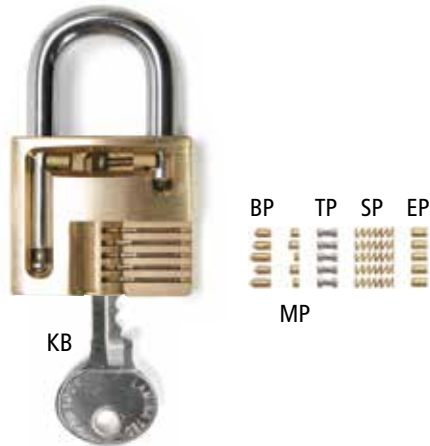

PART	SPECIFICATION	PIN #
BP	833	-1

PARTS

BP: Bottom pin
 MP: Master pin
 TP: Top pin
 SP: Spring
 EP: End plug

SPECIFICATION

832: 832 padlock
 833: 833 padlock
 834-35: 834/35 padlock
 836: padlock

PIN

-1: Pin #1
 -2: Pin #2
 -3: Pin #3
 -4: Pin #4
 -5: Pin #5

KEY	SPECIFICATION	KEYWAY
KB	834-35	A

KEY

KB: Key blank
 MK: Master key

SPECIFICATION

730: 730 padlock
 740: 740 padlock
 744-50: 740/750 padlock
 831: 831 padlock
 832: 832 padlock
 833: 833 padlock
 834-35: 834/35 padlock
 836: padlock

KEYWAY*

A: Corbin
 C: Cisa
 V: Guard (reverse)

*Optional keyways ONLY available for 834 or 834L padlocks.

BRASS PADLOCKS

SECURITY HARDWARE

SOLID BRASS PADLOCKS



- Solid brass body, polished finish
- Hardened steel shackle, nickel plated
- Single or double locking shackle
- Long shackle (L) models available
- Re-keyable cylinder with 3 keys

KEYING

KD: Keyed alike

*Keying services available

263L	KD
MODEL	KEYING

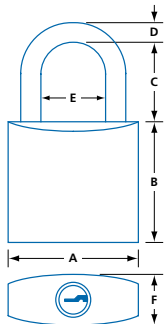

MODEL	SIZE	PIN	KEYING	BODY SIZE			SHACKLE SIZE			KEY ¹	/BOX
				A	B	F	C	E	øD		
SINGLE LOCKING											
261	20	3	KD	1 ³ / ₁₆ (20.6)	2 ⁵ / ₃₂ (19.5)	1 ³ / ₃₂ (10.4)	1 ³ / ₃₂ (10.5)	1 ³ / ₃₂ (10.7)	1/8 (3.2)	KB261	12
262	25	4	KD	3 ¹ / ₃₂ (24.9)	3 ¹ / ₃₂ (24.8)	1 ⁵ / ₃₂ (12.1)	3 ¹ / ₃₂ (24.8)	1/2 (12.5)	3/16 (4.4)	KB262	6
DOUBLE LOCKING											
263	32	4	KD	1 ¹ / ₄ (31.6)	1 ³ / ₁₆ (30.0)	9/16 (13.9)	1 ³ / ₁₆ (30.0)	2 ¹ / ₃₂ (16.8)	7/32 (5.4)	KB263	6
263L	32	5	KD	1 ¹ / ₄ (31.6)	1 ³ / ₁₆ (30.0)	9/16 (13.9)	1 ³ / ₁₆ (30.0)	2 ¹ / ₃₂ (16.8)	7/32 (5.4)	KB263	6
264	38	5	KD	1 ¹ / ₂ (37.8)	1 ³ / ₈ (35.0)	5/8 (15.6)	1 ³ / ₈ (35.0)	2 ⁵ / ₃₂ (19.7)	1/4 (6.3)	KB263	6
264L	38	5	KD	1 ¹ / ₂ (37.8)	1 ³ / ₈ (35.0)	5/8 (15.6)	1 ³ / ₈ (35.0)	2 ⁵ / ₃₂ (19.7)	1/4 (6.3)	KB263	6
265	50	6	KD	1 ³¹ / ₃₂ (49.8)	1 ¹¹ / ₁₆ (42.9)	3/4 (19.1)	1 (25.0)	1 (25.4)	1 ¹ / ₃₂ (8.7)	KB265	6

IN (MM)

(1) INDICATE HANDING WHEN ORDERING KEY BLANKS

IRON PADLOCKS

SECURITY HARDWARE

SOLID IRON PADLOCKS



- Solid iron body
- Hardened steel shackle, nickel plated
- Solid brass internal parts
- Single or double locking
- Key removable in both locked and unlocked position
- 2 keys supplied with models 361 and 362
- 3 keys supplied with models 363 to 367

KEYING

KD: Keyed alike

*Keying services available

263L	KA
MODEL	KEYING

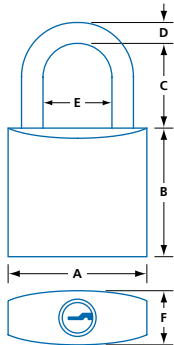

MODEL	SIZE	PINS	BODY SIZE			SHACKLE SIZE			KEY ¹	/BOX
			A	B	F	C	E	∅D		
DOUBLE LOCKING										
363	32	5	1¼ (32.0)	1¾/16 (30.0)	19/32 (15.0)	19/64 (5.2)	5/8 (16.0)	13/64 (5.2)	KB263	6
364	38	5	1½ (38.0)	1¾/8 (35.0)	11/16 (17.0)	¼ (6.3)	¾ (19.0)	¼ (6.3)	KB263	6
365	50	6	2 (51.0)	11¼/16 (43.0)	23/32 (18.4)	11/32 (8.8)	1 (25.0)	11/32 (8.8)	KB265	6

IN (MM)

(1) INDICATE HANDING WHEN ORDERING KEY BLANKS



VIRO PADLOCKS

SECURITY HARDWARE

Viro SOLID BRASS PADLOCKS



- Solid brass body, sanded finish
- Hardened steel shackle, nickel plated
- Solid brass cylinder, bolts and pins
- Stainless steel springs
- Key removable in locked or unlocked position
- Includes 2 nickel plated brass keys

OPTIONS

- KD:** Keyed different (LH default)
- SA:** Sub-assembled, indicate keyway handing (RH/LH)
- CKD:** Completely knocked down, indicate keyway handing (RH/LH)

*Keying services available

302	KD
MODEL	KEYING

Wide variety of padlocks and specialty locks available
– please contact to order or visit www.viro.it for details

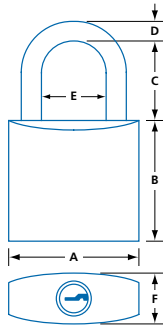

MODEL	SIZE	PINS	BODY SIZE			SHACKLE SIZE*			KEYING	QTY ¹
			A	B	F	C	E	∅D		
301	30	4	30.0	27.0	13.0	15.0	15.7	5.0	KD, SA, CKD	12
302	40	5	40.0	32.0	15.0	20.0	23.0	6.4	KD, SA, CKD	12
303	50	5	50.0	40.0	17.0	28.0	30.0	8.0	KD, SA, CKD	6
304	60	5	60.0	46.0	20.0	35.0	35.0	10.0	KD, SA, CKD	6
305	70	5	70.0	51.0	23.0	42.0	38.0	12.0	KD, SA	6

MM

(1) 12 : UNITS PER CASE

(*) OPTIONAL SHACKLE LENGTHS AVAILABLE – SEE AVAILABILITY CHART BELOW



MODEL	SIZE	SHACKLE SIZE			VIRO KEYWAY	KEY ¹
		C	E	∅D		
301.30		30.0	15.7	5.0		
301.40	30	40.0	15.7	5.0	011	301KB
301.64		64.0	15.7	5.0		
302.40		40.0	23.0	6.4		
302.64	40	64.0	23.0	6.4	013	302KB
302.90		90.0	23.0	6.4		
303.48		40.0	30.0	8.0		
303.64	50	64.0	30.0	8.0	015	302KB
303.90		90.0	30.0	8.0		
304.64	60	64.0	35.0	10.0	015	302KB
304.90		90.0	35.0	10.0		
305.64	70	64.0	38.0	12.0	015	302KB
305.90		90.0	38.0	12.0		

MM

PLEASE CONTACT REPRESENTATIVE FOR HELP ORDERING CUSTOM PADLOCKS OR SHACKLES

(1) KEY BLANKS AVAILABLE SEPARATELY

SPECIALTY PADLOCKS

SECURITY HARDWARE

Viro ARMoured PADLOCKS

PANZER, MONOLITH



4115 / 4116 / 4117

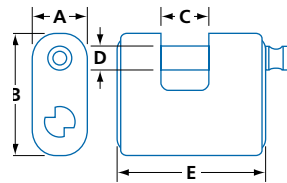

4125 / 4126

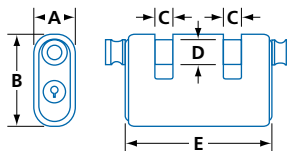

PANZER

- Solid forged brass one-piece padlock
- Chrome plated case-hardened steel main and side armour
- Chrome plated case-hardened steel anti-drill and pull resistant plate protecting the plug
- Case-hardened steel rotating lock bolt
- Lockbolt security protected by break-off handle if forced
- Mechanism: key-retaining, ball-type locking
- Cylinder: 7-pin Viro039 keyway, re-keyable
- Supplied with 3 nickel plated brass keys
- Parts and pins available-please contact

Wide variety of padlocks and specialty locks available – please contact to order or visit www.viro.it for details



4117KB039

Nickel plated
brass key blank

MODEL	KEYING	SIZE	KEYWAY	A	B	C	ø D	E	/BOX
4115	KD	62	039RH	$\frac{29}{32}$ (23)	2 (51)	$\frac{25}{32}$ (20)	$\frac{13}{32}$ (10)	$\frac{27}{16}$ (62)	1
4116	KD	77	039RH	$\frac{15}{32}$ (29)	$\frac{27}{16}$ (62)	$\frac{1}{16}$ (27)	$\frac{15}{32}$ (12)	$\frac{31}{32}$ (77)	1
4117	KD	86	039RH	$\frac{15}{32}$ (29)	$\frac{27}{32}$ (72)	$\frac{113}{32}$ (36)	$\frac{15}{32}$ (12)	$\frac{33}{8}$ (86)	1
4125	KD	78	039RH	$\frac{29}{32}$ (23)	2 (51)	$\frac{13}{32}$ (10)	$\frac{13}{32}$ (10)	$\frac{31}{16}$ (78)	1
4126	KD	86	039RH	$\frac{15}{32}$ (29)	$\frac{27}{16}$ (62)	$\frac{7}{16}$ (11.5)	$\frac{15}{32}$ (12)	$\frac{33}{8}$ (86)	1

IN (MM)

MONOLITH

- One-piece, special case-hardened and tempered steel body, corrosion-resistant nickel plating
- Case-hardened and tempered steel rotating lockbolt
- Lockbolt security protected by break-off handle if forced
- 7-pin security system, replaceable and rekeyable, protected by a rotating anti-drill plate in special case-hardened, tempered $\frac{3}{16}$ " (4.4 mm) thick steel
- Supplied with 2 nickel plated brass keys



4143 / 4144

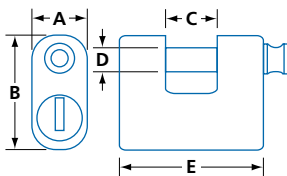

MODEL	KEYING	SIZE	KEYWAY	A	B	C	ø D	E	/BOX
4143	KD	78	039RH	$\frac{13}{16}$ (30)	$\frac{27}{16}$ (62)	$\frac{13}{32}$ (28)	$\frac{1}{2}$ (13)	$\frac{31}{16}$ (78)	1
4144	KD	87	039RH	$\frac{13}{16}$ (30)	$\frac{23}{4}$ (70)	$\frac{115}{32}$ (37)	$\frac{1}{2}$ (13)	$\frac{37}{16}$ (87)	1

IN (MM)

DOREX MORTISE LOCKS

SECURITY HARDWARE

DOREX DL2400 DEADLATCH LOCK

DL24

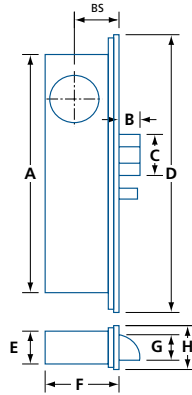

- Heavy zinc plated steel construction
- Chrome plated latch bolt with Delrin insert for smooth, quiet latching
- ½" (12.7 mm) latch throw
- Zinc alloy dead locking pin
- Left or right handed, field reversible
- Cylinder backset: ¾" (24.6 mm) or 1 ⅛" (28.6 mm)
- Lock accepts standard 1 ⅝" (29.4 mm) diameter mortise cylinder with cam A (Adams Rite type)
- Key or turn-button controlled latch dogging
- Radius anodized aluminum (#FP32) faceplate included
- Strike not included
- Other faceplates, strikes, and accessories available, see page 05.203

MODEL	FINISH	HANDING	BS	A	B	C	D	E	F	G	H	/CASE
DL2412-2	AL, DU	LH	¾" (24.6)	5 ⅞" (148.1)	½" (12.7)	1 (25.3)	6 ⅞" (174.6)	⅞" (22.2)	1 ⅝" (41.3)	⅝" (16.2)	1 (25.4)	25
DL2422-2	AL, DU	RH										
DL2413-2	AL, DU	LH	1 ⅛" (28.6)	5 ⅞" (148.1)	½" (12.7)	1 (25.3)	6 ⅞" (174.6)	⅞" (22.2)	1 ¾" (44.5)	⅝" (16.2)	1 (25.4)	25
DL2423-2	AL, DU	RH										

IN (MM)

DOREX DL2500 DEADLATCH LOCK – HEAVY DUTY

DL25

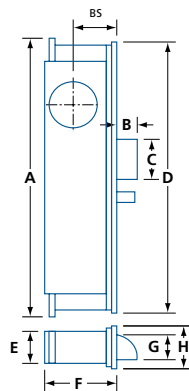

- Heavy zinc plated steel construction
- Adjustable mounting studs for easy lock alignment
- Solid zinc alloy latch bolt with ½" (12.7 mm) throw
- Zinc alloy dead locking pin
- Left or right handed, field reversible
- Cylinder backset: ¾" (24.6 mm) or 1 ⅛" (28.6 mm)
- Lock accepts standard 1 ⅝" (29.4 mm) diameter mortise cylinder with cam A (Adams Rite type)
- Key or turn-button controlled latch dogging
- Radius anodized aluminum (#FP32) faceplate included
- Strike not included
- Other faceplates, strikes, and accessories available, see page 05.203

MODEL	FINISH	HANDING	BS	A	B	C	D	E	F	G	H	/CASE
DL2512-2	AL, DU	LH	¾" (24.6)	7 (177.8)	½" (12.7)	1 (25.4)	6 ⅞" (174.6)	⅞" (22.5)	1 ⅞" (40.6)	⅝" (15.7)	1 (25.4)	25
DL2522-2	AL, DU	RH										
DL2513-2	AL, DU	LH	1 ⅛" (28.6)	7 (177.8)	½" (12.7)	1 (25.4)	6 ⅞" (174.6)	⅞" (22.5)	1 ¾" (44.5)	⅝" (15.7)	1 (25.4)	25
DL2523-2	AL, DU	RH										

IN (MM)

DOREX MORTISE LOCKS

SECURITY HARDWARE

DOREX DB2100 DEADBOLT LOCK

DB21

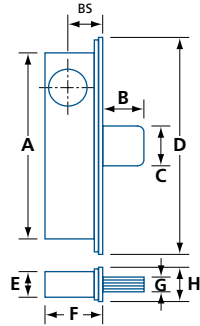

- Heavy zinc plated steel construction
- 5-ply laminated steel pivot bolt with 3 case-hardened center plies plus hardened roll pin (sawing test meets ANSI performance specifications)
- 1³/₈" (35.1 mm) bolt throw
- Non-handed
- Cylinder backset: 7⁷/₈" (22.2 mm), 3¹/₂" (24.6 mm) or 1¹/₈" (28.6 mm)
- Lock accepts standard 1⁵/₃₂" (29.4 mm) diameter mortise cylinder with cam A (Adams Rite type)
- Flat anodized aluminum (#FP11) faceplate included
- Strike not included
- Other faceplates, strikes, and accessories available, see page 05.203

MODEL	FINISH	BS	A	B	C	D	E	F	G	H	/CASE
DB2101-1	AL, DU	7 ⁷ / ₈ (22.2)	6 (152.7)	1 ³ / ₈ (35.1)	1 ³ / ₈ (34.4)	6 ⁷ / ₈ (174.6)	2 ⁹ / ₃₂ (22.8)	1 ¹⁹ / ₃₂ (40.0)	5 ⁵ / ₈ (15.3)	1 (25.4)	25
DB2102-1	AL, DU	3 ¹ / ₂ (24.6)	6 (152.7)	1 ³ / ₈ (35.1)	1 ³ / ₈ (34.4)	6 ⁷ / ₈ (174.6)	2 ⁹ / ₃₂ (22.8)	1 5/8 (41.2)	5 ⁵ / ₈ (15.3)	1 (25.4)	25
DB2103-1	AL, DU	1 ¹ / ₈ (28.6)	6 (152.7)	1 ³ / ₈ (35.1)	1 ³ / ₈ (34.4)	6 ⁷ / ₈ (174.6)	2 ⁹ / ₃₂ (22.8)	1 25/32 (45.1)	5 ⁵ / ₈ (15.3)	1 (25.4)	25

IN (MM)

DOREX DB2200 DEADBOLT LOCK – SHORT THROW

DB22

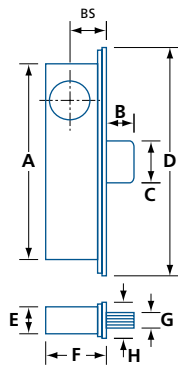

- Heavy zinc plated steel construction
- 5-ply laminated steel pivot bolt with 3 case-hardened center plies plus hardened roll pin (sawing test meets ANSI performance specifications)
- 1³/₁₆" (20.5 mm) bolt throw
- Non-handed
- Cylinder backset: 3¹/₂" (24.6 mm) or 1¹/₈" (28.6 mm)
- Lock accepts standard 1⁵/₃₂" (29.4 mm) diameter mortise cylinder with cam A (Adams Rite type)
- Flat anodized aluminum (#FP21) faceplate included
- Strike not included
- Other faceplates, strikes, and accessories available, see page 05.203

MODEL	FINISH	BS	A	B	C	D	E	F	G	H	/CASE
DB2202-1	AL, DU	3 ¹ / ₂ (24.6)	6 (152.7)	1 ³ / ₁₆ (20.5)	1 ¹¹ / ₃₂ (34.1)	6 ⁷ / ₈ (174.6)	2 ⁹ / ₃₂ (22.9)	1 ⁵ / ₈ (41.4)	5 ⁵ / ₈ (15.3)	1 (25.4)	25
DB2203-1	AL, DU	1 ¹ / ₈ (28.6)	6 (152.7)	1 ³ / ₁₆ (20.5)	1 ¹¹ / ₃₂ (34.1)	6 ⁷ / ₈ (174.6)	2 ⁹ / ₃₂ (22.9)	1 ²⁵ / ₃₂ (45.1)	5 ⁵ / ₈ (15.3)	1 (25.4)	25

IN (MM)



DOREX MORTISE LOCKS

SECURITY HARDWARE

DOREX HB2300 HOOKBOLT LOCK

HB23

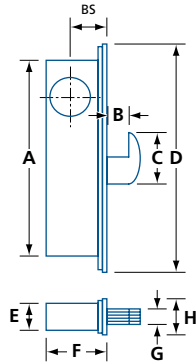

- Heavy zinc plated steel construction
- 5-ply laminated steel pivot bolt with 3 case-hardened center plies plus hardened roll pin (sawing test meets ANSI performance specifications)
- $1\frac{9}{16}$ " (20.5 mm) bolt throw
- Non-handed
- Cylinder backset: $\frac{31}{32}$ " (24.6 mm) or $1\frac{1}{8}$ " (28.6 mm)
- Lock accepts standard $1\frac{5}{32}$ " (29.4 mm) diameter mortise cylinder with cam A (Adams Rite type)
- Flat anodized aluminum (#FP21) faceplate included
- Strike not included
- Other faceplates, strikes, and accessories available, see page 05.203

MODEL	FINISH	BS	A	B	C	D	E	F	G	H	/CASE
HB2302-1	AL, DU	$\frac{31}{32}$ (24.6)	6 (152.7)	$\frac{17}{32}$ (13.4)	$1\frac{1}{4}$ (31.8)	$\frac{67}{8}$ (174.6)	$\frac{29}{32}$ (22.9)	$1\frac{5}{8}$ (41.4)	$\frac{5}{8}$ (15.3)	1 (25.4)	25
HB2303-1	AL, DU	$1\frac{1}{8}$ (28.6)	6 (152.7)	$\frac{17}{32}$ (13.4)	$1\frac{1}{4}$ (31.8)	$\frac{67}{8}$ (174.6)	$\frac{29}{32}$ (22.9)	$1\frac{25}{32}$ (45.1)	$\frac{5}{8}$ (15.3)	1 (25.4)	25

IN (MM)

DOREX MORTISE LOCKS

SECURITY HARDWARE

DOREX MORTISE LOCK FACEPLATES

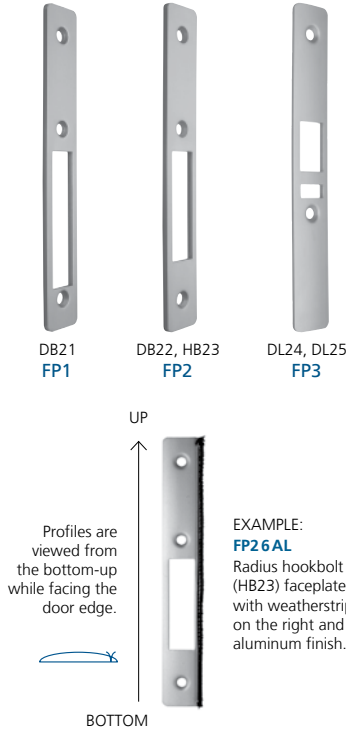

SERIES	PROFILE	DESCRIPTION	MODEL	FINISH	/CASE
DB21	1	Flat 6 $\frac{7}{8}$ x1 (174.6x25.4)	FP11	AL DU	25
HB23, DB22			FP21		
DL24, DL25			FP31		
DB21	3	Bevelled, left 6 $\frac{7}{8}$ x1 (174.6x25.4)	FP13	AL DU	25
HB23, DB22			FP23		
DL24, DL25			FP33		
DB21	4	Bevelled, right 6 $\frac{7}{8}$ x1 (174.6x25.4)	FP14	AL DU	25
HB23, DB22			FP24		
DL24, DL25			FP34		
DB21	2	Radius 6 $\frac{7}{8}$ x1 (174.6x25.4)	FP12	AL DU	25
HB23, DB22			FP22		
DL24, DL25			FP32		
DB21	5	Radius, weatherstrip left 6 $\frac{7}{8}$ x1 (174.6x25.4)	FP15	AL DU	25
HB23, DB22			FP25		
DL24, DL25			FP35		
DB21	6	Radius, weatherstrip right 6 $\frac{7}{8}$ x1 (174.6x25.4)	FP16	AL DU	25
HB23, DB22			FP26		
DL24, DL25			FP36		

IN (MM) ALL FACEPLATES ARE ANODIZED ALUMINUM

DOREX MORTISE LOCK GUARDS

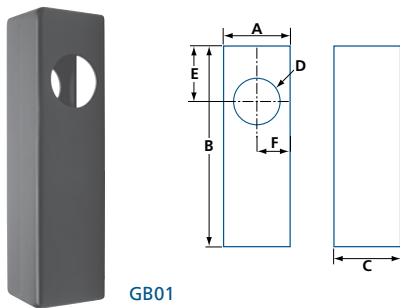

GB01 GUARD BOX

- Heavy gauge steel guard box for DB or HB series for added protection
- Accepts standard 1 $\frac{1}{8}$ " (28.6mm) backset mortise deadbolt or hookbolt with 1 $\frac{5}{32}$ " (29.4mm) diameter mortise cylinder

MODEL	A	B	C	D	E	F
GB01	1 $\frac{31}{32}$ (50)	7 (177.8)	1 $\frac{3}{4}$ (44.5)	1 $\frac{1}{4}$ (31.8)	1 $\frac{11}{16}$ (42.9)	2 $\frac{7}{32}$ (21.4)

IN (MM)

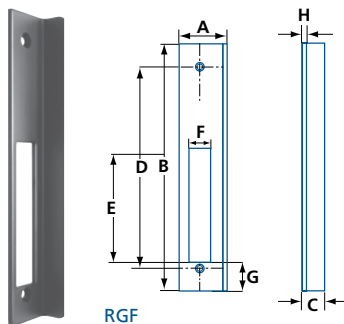

LGf/RGf FACEPLATE GUARD

- Heavy gauge steel faceplate guard provides added protection
- Used with guard box #GB01

MODEL	A	B	C	D	E	F	G	H
LGf/RGf	1 $\frac{1}{4}$ (31.8)	6 $\frac{7}{8}$ (174.6)	5 $\frac{5}{8}$ (15.9)	5 $\frac{5}{8}$ (142.9)	3 $\frac{3}{16}$ (80.9)	5 $\frac{5}{8}$ (15.9)	1 $\frac{3}{16}$ (20.6)	1 $\frac{1}{8}$ (3.2)

IN (MM)



DOREX MORTISE LOCKS

SECURITY HARDWARE

DOREX MORTISE LOCK STRIKES



LS01 DL STRIKE

- Standard flat stainless steel deadlatch strike
- Includes dustbox, mounting plate and machine screws

LS02 DL STRIKE

- Flat reversible stainless steel deadlatch strike (used when converting to DL series from door prepped for DB or HB series)
- Includes black plastic dust box, steel mounting plate and machine screws



DBSTR DB STRIKE

- Heavy duty zinc plated deadbolt strike

HBSTR HB STRIKE

- Heavy duty zinc plated hookbolt strike

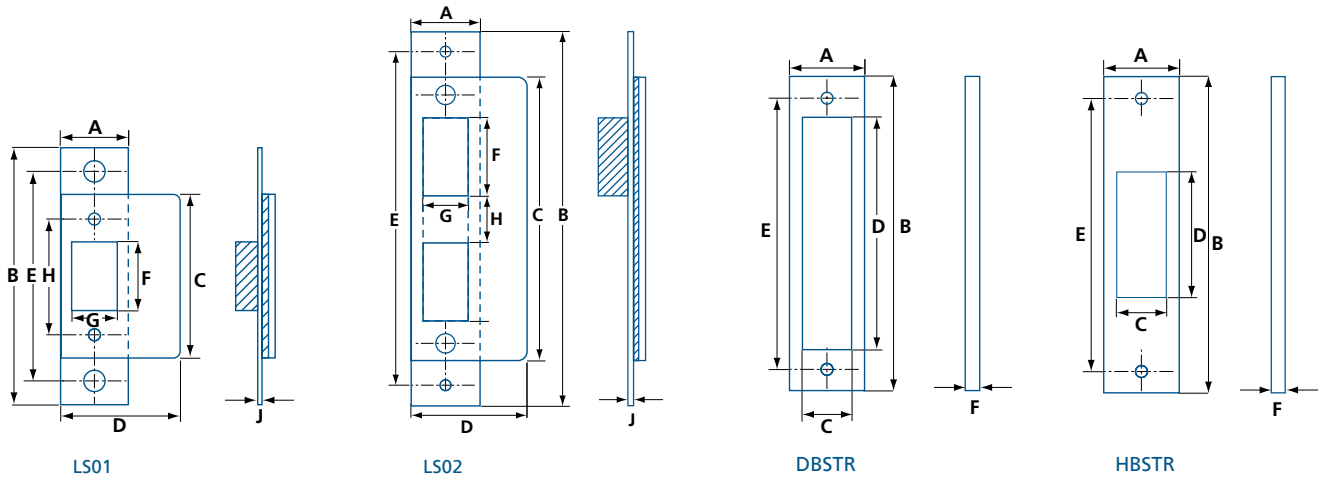

MODEL	A	B	C	D	E	F	G	H	J
LS01	1 $\frac{1}{8}$ (28.6)	4 $\frac{9}{64}$ (105)	2 $\frac{5}{8}$ (66.7)	1 $\frac{29}{32}$ (48.4)	3 $\frac{3}{4}$ (85.7)	1 $\frac{1}{8}$ (28.6)	$\frac{3}{4}$ (19.1)	1 $\frac{7}{8}$ (47.6)	$\frac{3}{32}$ (2.4)
LS02	1 $\frac{1}{8}$ (28.6)	6 $\frac{3}{32}$ (154.7)	4 $\frac{5}{8}$ (117.5)	1 $\frac{29}{32}$ (48.4)	5 $\frac{3}{8}$ (136.5)	1 $\frac{1}{8}$ (28.6)	$\frac{3}{4}$ (19.1)	$\frac{7}{8}$ (22.2)	$\frac{3}{32}$ (2.4)
DBSTR	1 $\frac{3}{16}$ (30.2)	4 $\frac{7}{8}$ (47.6)	$\frac{5}{8}$ (15.9)	3 $\frac{3}{8}$ (85.7)	4 $\frac{1}{16}$ (103.2)	$\frac{1}{8}$ (3.2)	—	—	—
HBSTR	1 $\frac{3}{16}$ (30.2)	4 $\frac{7}{8}$ (47.6)	$\frac{5}{8}$ (15.9)	1 $\frac{5}{8}$ (41.3)	4 $\frac{1}{16}$ (103.2)	$\frac{1}{8}$ (3.2)	—	—	—

IN (MM)

VIRO MORTISE LOCKS

SECURITY HARDWARE

VIRO DEADLATCH LOCK

8516, 8517, 8518, 8519

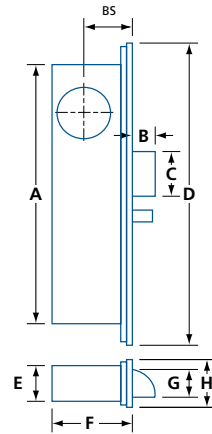

- Heavy galvanized steel construction
- Solid zinc alloy latch bolt
- Zinc alloy dead locking pin with ball bearing tip
- $1\frac{7}{32}$ " (13.6 mm) latch throw
- Reversible
- Cylinder backset: $\frac{7}{8}$ " (22.2 mm), $\frac{31}{32}$ " (24.6 mm), $1\frac{1}{8}$ " (28.6 mm) or $1\frac{1}{2}$ " (38.1 mm)
- Lock accepts standard $1\frac{5}{32}$ " (29.4 mm) diameter mortise cylinder with cam A (Adams Rite type)
- Key or turn-button controlled latch dogging
- Faceplate #9902C28 sold separately

Wide variety of padlocks and specialty locks available – please contact to order or visit www.viro.it for details

MODEL	BS	A	B	C	D	E	F	G	H
8516	$\frac{7}{8}$ (22.2)	$5\frac{13}{16}$ (147.3)	$\frac{17}{32}$ (13.6)	1 (25.3)	$6\frac{7}{8}$ (174.9)	$\frac{7}{8}$ (22.4)	$1\frac{1}{2}$ (38.2)	$\frac{5}{8}$ (16.0)	1 (25.2)
8517	$\frac{31}{32}$ (24.6)	$5\frac{13}{16}$ (147.3)	$\frac{17}{32}$ (13.6)	1 (25.3)	$6\frac{7}{8}$ (174.9)	$\frac{7}{8}$ (22.4)	$1\frac{19}{32}$ (40.6)	$\frac{5}{8}$ (16.0)	1 (25.2)
8518	$1\frac{1}{8}$ (28.6)	$5\frac{13}{16}$ (147.3)	$\frac{17}{32}$ (13.6)	1 (25.3)	$6\frac{7}{8}$ (174.9)	$\frac{7}{8}$ (22.4)	$1\frac{3}{4}$ (44.6)	$\frac{5}{8}$ (16.0)	1 (25.2)
8519	$1\frac{1}{2}$ (38.1)	$5\frac{13}{16}$ (147.3)	$\frac{17}{32}$ (13.6)	1 (25.3)	$6\frac{7}{8}$ (174.9)	$\frac{7}{8}$ (22.4)	$2\frac{1}{8}$ (54.1)	$\frac{5}{8}$ (16.0)	1 (25.2)

IN (MM)

VIRO DEADBOLT LOCK

8506, 8507, 8508

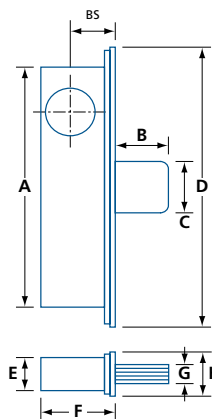

- Heavy galvanized steel construction
- Tough laminated swinging deadbolt
- $1\frac{3}{8}$ " (34.9 mm) latch throw
- Non-handed
- Cylinder backset: $\frac{7}{8}$ " (22.2 mm), $\frac{31}{32}$ " (24.6 mm), or $1\frac{1}{8}$ " (28.6 mm)
- Lock accepts standard $1\frac{5}{32}$ " (29.4 mm) diameter mortise cylinder with cam A (Adams Rite type)
- Faceplate #9934C28 sold separately

Wide variety of padlocks and specialty locks available – please contact to order or visit www.viro.it for details

MODEL	BS	A	B	C	D	E	F	G	H
8506	$\frac{7}{8}$ (22.2)	6 (152.5)	$1\frac{3}{8}$ (34.9)	$1\frac{3}{8}$ (34.3)	$6\frac{7}{8}$ (174.9)	1 (25.2)	$1\frac{17}{32}$ (38.9)	$\frac{19}{32}$ (15.0)	1 (25.2)
8507	$\frac{31}{32}$ (24.6)	6 (152.5)	$1\frac{3}{8}$ (34.9)	$1\frac{3}{8}$ (34.3)	$6\frac{7}{8}$ (174.9)	1 (25.2)	$1\frac{5}{8}$ (41.3)	$\frac{19}{32}$ (15.0)	1 (25.2)
8508	$1\frac{1}{8}$ (28.6)	6 (152.5)	$1\frac{3}{8}$ (34.9)	$1\frac{3}{8}$ (34.3)	$6\frac{7}{8}$ (174.9)	1 (25.2)	$1\frac{23}{32}$ (45.3)	$\frac{19}{32}$ (15.0)	1 (25.2)

IN (MM)

VIRO MORTISE LOCKS

SECURITY HARDWARE

VIRO HOOKBOLT LOCK

8513, 8514

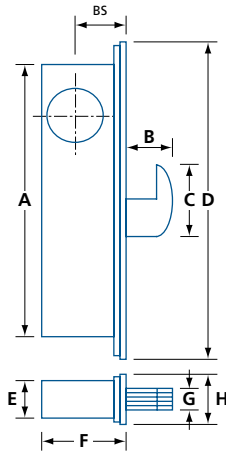

- Heavy galvanized steel construction
- Tough laminated swinging hookbolt
- $1\frac{3}{16}$ " (20.6 mm) latch throw
- Non-handed
- Cylinder backset: $1\frac{1}{8}$ " (28.6 mm) or $1\frac{1}{2}$ " (38.1 mm)
- Lock accepts standard $1\frac{5}{32}$ " (29.4 mm) diameter mortise cylinder with cam A (Adams Rite type)
- Faceplate #9946C28 sold separately

Wide variety of padlocks and specialty locks available – please contact to order or visit www.viro.it for details

MODEL	BS	A	B	C	D	E	F	G	H
8513	$1\frac{1}{8}$ (28.6)	6 (152.5)	$1\frac{3}{16}$ (20.6)	$1\frac{1}{4}$ (31.3)	$6\frac{7}{8}$ (174.9)	$\frac{7}{8}$ (22.0)	$1\frac{23}{32}$ (45.3)	$\frac{5}{8}$ (16.0)	1 (25.2)
8514	$1\frac{1}{2}$ (38.1)	6 (152.5)	$1\frac{3}{16}$ (20.6)	$1\frac{1}{4}$ (31.3)	$6\frac{7}{8}$ (174.9)	$\frac{7}{8}$ (22.0)	$2\frac{1}{4}$ (56.8)	$\frac{5}{8}$ (16.0)	1 (25.2)

IN (MM)

VIRO FACEPLATES

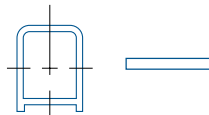

- Faceplates for VIRO deadlatch, deadbolt and hookbolt locks
- Flat anodized aluminum faceplate

MODEL	LOCK	WIDTH	LENGTH	THICKNESS	/BOX
9902C28	Deadlatch				
9934C28	Deadbolt	1 (25.4)	$6\frac{7}{8}$ (174.9)	$\frac{1}{8}$ (3.2)	20
9946C28	Hookbolt				

IN (MM)



HANDLES & PADDLES

SECURITY HARDWARE

DOREX LEVER HANDLE



RIGHT HAND (RH)
HANDLE SHOWN

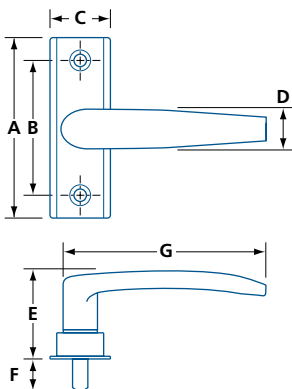

- Lever handle with cam for DL2000 series deadlatch, to be used on 1 $\frac{3}{4}$ " (44 mm) thick aluminum doors
- Left hand or right hand, field reversible
- Sturdy and dependable aluminum alloy construction
- Hardened steel spindle and cam
- 3" (76 mm) center to center mounting holes
- Cam (#0112PLUGLH / RH) included but also sold separately

#0112RH for Right Hand Reverse (RHR) or right hand (RH) doors

#0112LH for Left Hand Reverse (LHR) or left hand (LH) doors

For LH handle in Left Hand Reversed use #0112PLUGRH
For RH handle in Right Hand Reversed use #0112PLUGLH

MODEL	HAND	FINISH	A	B	C	D	E	F	G	/CASE
0112	LH, RH	C20D, C28	4 (101.5)	3 (76.0)	1 $\frac{11}{32}$ (34.0)	$\frac{7}{8}$ (22.4)	1 $\frac{15}{16}$ (48.8)	2 $\frac{3}{32}$ (18.0)	3 $\frac{3}{4}$ (95.1)	50

IN (MM) LH: LEFT HAND, RH: RIGHT HAND

DOREX PUSH/PULL PADDLE

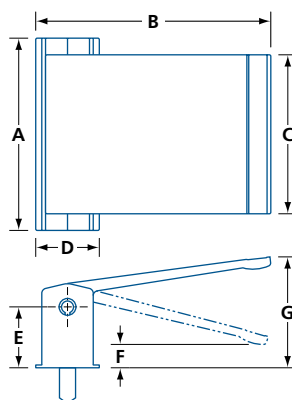
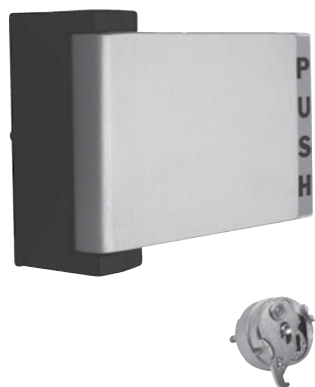

- PUSH / PULL paddle with cam for DL2000 series deadlatch
- Left hand or right hand, field reversible
- Zinc alloy base
- Extruded and anodized aluminum paddle
- 3" (76.2 mm) center to center concealed mounting holes
- Spring (#5590S) and extension kit (#5590SPK) for 2 $\frac{1}{4}$ " (57.2 mm) door thickness are available
- Cam (0112PLUGLH / RH) included but also sold separately

#5590*R for Right Hand Reverse (RHR) or right hand (RH) outswing doors

#5590*L for Left Hand Reverse (LHR) or left hand (LH) outswing doors

For LH handle in Left Hand Reversed use #0112PLUGRH
For RH handle in Right Hand Reversed use #0112PLUGLH

MODEL	FINISH	HAND	A	B	C	D	E	F	G	/CASE
5590	C20D, C28	L, R	4 $\frac{1}{32}$ (102.8)	4 $\frac{15}{16}$ (125.7)	3 $\frac{11}{32}$ (85.0)	1 $\frac{11}{32}$ (34.0)	1 $\frac{5}{16}$ (33.0)	$\frac{9}{16}$ (14.0)	2 $\frac{3}{8}$ (60.0)	20

IN (MM) L: LEFT HAND, R: RIGHT HAND

ELECTRIC STRIKES

SECURITY HARDWARE

UNIVERSAL ELECTRIC STRIKE

SGT78

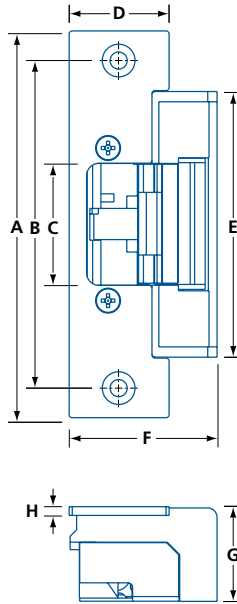

- Heavy duty (Grade 2 – 900,000 cycles)
- Low profile body fits most metal frames
- Non handed, reversible
- 12/24 AC/DC voltage (300mA@12VDC / 150mA@24VDC)
- Varistor included (surge protection)
- Static strength: 1000 lbs (454 kg)
- Dynamic strength: 50 ft-lbs (68 N-m)
- Field configurable Fail Safe (unlocked) / Fail Secure (locked)
- Includes three (3) stainless steel faceplates: ANSI Round, ANSI Square and Wood Door (see below)
- 5-year limited warranty

MODEL	FINISH	A	B	C	D	E	F	G	H
SGT78	630	47/8 (123)	41/8 (104)	117/32 (39)	11/4 (32)	33/8 (85)	17/8 (47)	17/32 (31)	1/8 (3)

IN (MM)



FP6145Q

FP604RO

FP608RO

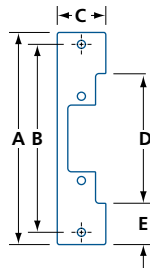

- Stainless steel face plates
- Included with #SGT78 only, not available individually
- FP604RO & FP608RO, with 5/32" (4 mm) radius

FACEPLATE TYPE		A	B	C	D	E
FP6145Q	ANSI SQUARE	47/8 (123)	41/8 (104)	11/4 (32)	33/8 (85)	3/4 (19)
FP604RO	ANSI ROUND					
FP608RO	WOOD DOOR	715/16 (203)	71/2 (189)	17/16 (37)	33/8 (85)	29/32 (58)

IN (MM)

ELECTRIC STRIKES

SECURITY HARDWARE



ELECTRIC STRIKES

700, 710

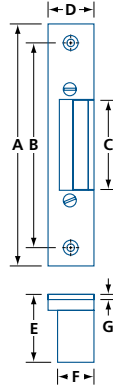

- Tough zinc alloy strike latch for wood frame application
- Reliable, mechanical and electrical components
- $\frac{5}{32}$ " (4.0 mm) horizontal adjustment after installation
- Designed for a latch projection up to $\frac{5}{8}$ " (15.9 mm)
- Symmetrical construction, non-handed
- Faceplate finish: heavy coat of metallic silver lacquer
- Electrical mode: "Fail Secure (locked)"
- Buzz sound occurs only if AC current is used
- Duty cycle: Intermittent (60 seconds maximum)
- 2-year limited warranty (excessive force and coil burn-out not included)

MODEL	MODE	DUTY CYCLE	VOLTAGE	CURRENT	RESISTANCE	SOUND
700-16	Fail Secure (locked)	Intermittent	8-24 AC	0.36-1.09A	18 Ω	Buzz (AC only)
			8-16 DC	0.44-0.89A	18 Ω	

MODEL	A	B	C	D	E	F	G	/CASE
700	$\frac{57}{32}$ (133)	$\frac{47}{16}$ (112.6)	$\frac{115}{16}$ (49.6)	1 (25.2)	$\frac{115}{32}$ (37.7)	$\frac{13}{16}$ (20.4)	$\frac{1}{8}$ (3.2)	100

IN (MM)

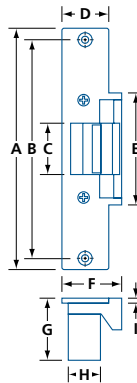

- Tough zinc alloy strike latch for metal frame application
- Reliable, well-functioning mechanical and electrical components
- $\frac{5}{32}$ " (4.0 mm) horizontal adjustment after installation
- Designed for a latch projection up to $\frac{5}{8}$ " (15.9 mm)
- Symmetrical construction, non-handed
- Faceplate finish: heavy coat of metallic silver lacquer
- Electrical mode: "Fail Secure (locked)"
- Buzz sound occurs only if AC current is used
- Duty cycle: Intermittent (60 seconds maximum)
- 2-year limited warranty (excessive force and coil burn-out not included)

MODEL	MODE	DUTY CYCLE	VOLTAGE	CURRENT	RESISTANCE	SOUND
710-16	Fail Secure (locked)	Intermittent	16-24 AC	0.36-1.09A	40 Ω	Buzz (AC only)
			16-24 DC	0.44-0.89A	18 Ω	
710-24	Fail Secure (locked)	Intermittent	8-24 AC	0.30-0.45A	18 Ω	Buzz (AC only)
			8-16 DC	0.40-0.60A	18 Ω	

MODEL	A	B	C	D	E	F	G	H	I	/CASE
710	$\frac{529}{32}$ (149.9)	$\frac{55}{16}$ (134.7)	1¼ (31.9)	$\frac{15}{32}$ (29.1)	$\frac{223}{32}$ (69.1)	$\frac{115}{32}$ (37.2)	$\frac{117}{32}$ (38.5)	$\frac{25}{32}$ (19.9)	$\frac{1}{8}$ (3.2)	100

IN (MM)



MORTISE CYLINDERS

SECURITY HARDWARE

MORTISE CYLINDERS – BRASS

MC



MC



KEY CYLINDER

- Solid brass cylinder with 5 or 6 pins
- Drilled for Construction Master Key (CMK)
- Adams Rite type (A) cam included
- Trim ring NOT included; sold separately (#COL6-26D)
- Keyways: Schlage (SC), Yale (YA) or Weiser (WR)
- Includes 2 keys
- Cam type B available; sold separately (#MC-CAMB)

MC	118	A	-	SC	KD6	-	26D
MODEL	LENGTH	CAM	KEY	KEYING	FINISH		

MODEL	LENGTH	∅A	B	∅C	CAM	KEYWAY	KEYING	PINS	FINISH	/CASE
MC	100	1 ³ / ₈ (35)	1 (25.4)	1 ⁵ / ₃₂ (29.1)	A	SC, YA, WR	KD, KAX2	5	26D	100
MC	118	1 ³ / ₈ (35)	1 ¹ / ₈ (29)	1 ⁵ / ₃₂ (29.1)	A	SC, YA, WR	KD6	6	26D, 10B	100
MC	114	1 ³ / ₈ (35)	1 ¹ / ₄ (32)	1 ⁵ / ₃₂ (29.1)	A	SC, YA	KD6	6	26D	100

IN (MM) (*) FULL KEYING SERVICES AVAILABLE. KAX2: KEYED ALIKE, PAIRED CYLINDERS, 50 PAIRS PER CASE
 KD: KEYED DIFFERENT, 5 PIN, DRILLED 6
 KD6: KEYED DIFFERENT, 6PINS



M-D

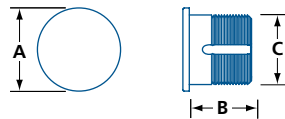

DUMMY CYLINDER

- Solid brass construction (not hollow)
- Trim ring NOT included; sold separately (#COL6-26D)

M	100	-	D	-	20D
MODEL	LENGTH	TYPE	FINISH		



M-T

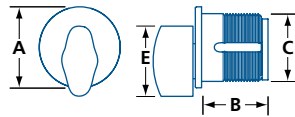

THUMB-TURN CYLINDERS

- Solid brass construction
- Ergonomic ADA thumb-turn for easy turning (TA)
- Regular thumb-turn available (T)
- Adams Rite type (A) cam included
- Trim ring NOT included; sold separately (#COL6-26D)
- Cam type B available; sold separately (#MC-CAMB)



M-TA

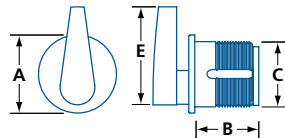

M	118	A	-	TA	-	26D
MODEL	LENGTH	CAM	TYPE	FINISH		

MODEL	LENGTH	∅A	B	∅C	E	CAM	TYPE	FINISH	/CASE
M	100	1 ³ / ₈ (35)	1 (25.4)	1 ⁵ / ₃₂ (29.1)	—	—	D, T, TA	26D, 10B	100
M	118	1 ³ / ₈ (35)	1 ¹ / ₈ (29)	1 ⁵ / ₃₂ (29.1)	1 (25.4)	A	TA	26D	100
M	114	1 ³ / ₈ (35)	1 ¹ / ₄ (32)	1 ⁵ / ₃₂ (29.1)	1 ³ / ₄ (44.5)	A	TA	26D	100

IN (MM)

MORTISE CYLINDERS

SECURITY HARDWARE

MORTISE CYLINDERS – BRASS

CBM

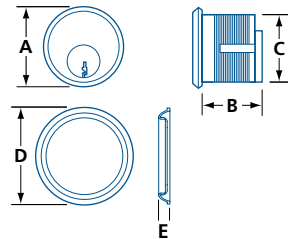

KEY CYLINDER

- Solid brass construction with aluminum clad face
- 5-pin, or 5-pin drilled for 6-pin
- Trim ring included
- Keyways: Schlage (SC), Yale #9 (Y9) or Weiser (WR)
- Includes 2 keys
- Cams: Adams Rite type (cam A) or Yale type (cam B)

CBM	118	A	-	SC	KD	-	28
MODEL	LENGTH	CAM	KEY	KEYING	FINISH		

MODEL	LENGTH	∅A	B	∅C	D	E	CAM	KEYWAY	KEYING	PINS	FINISH	/CASE
CBM	034	1 ³ / ₈ (35)	3/4 (19)	1 ⁵ / ₃₂ (29.1)	1 ⁹ / ₁₆ (40)	7/32 (5.7)	A, B	SC, Y9, WR	KA, KA2, KD	5	20D, 26D, 28	100
CBM	100	1 ³ / ₈ (35)	1 (25.4)	1 ⁵ / ₃₂ (29.1)	1 ⁹ / ₁₆ (40)	7/32 (5.7)	A, B	SC, Y9, WR	KA, KA2, KD	5	20D, 26D, 28	100
CBM	118	1 ³ / ₈ (35)	1 ¹ / ₈ (29)	1 ⁵ / ₃₂ (29.1)	1 ⁹ / ₁₆ (40)	7/32 (5.7)	A, B	SC, Y9, WR	KA, KA2, KD	5*	20D, 26D, 28	100
CBM	114	1 ³ / ₈ (35)	1 ¹ / ₄ (32)	1 ⁵ / ₃₂ (29.1)	1 ⁹ / ₁₆ (40)	7/32 (5.7)	A, B	SC, Y9, WR	KA, KA2, KD	5*	20D, 26D, 28	100

IN (MM) (*) 5-PIN CYLINDER, DRILLED 6

KA: KEYED ALIKE KA2: KEYED ALIKE, PAIRED CYLINDERS, 50 PAIRS PER CASE
KD: KEYED DIFFERENT

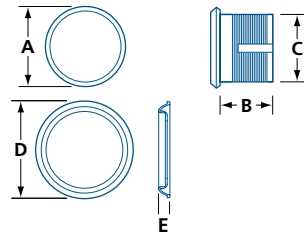

DUMMY CYLINDER

- Solid brass construction with aluminum clad face
- Trim ring included

CBM	100	-	DM	-	28
MODEL	LENGTH	TYPE	FINISH		

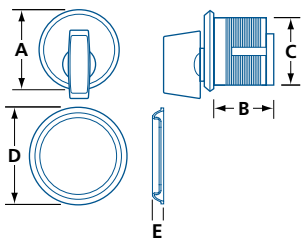

THUMB-TURN CYLINDER

- Solid brass construction with aluminum clad face
- Trim ring included
- Cams: Adams Rite type (cam A) or Yale type (cam B)

CBM	100	A	-	T1	-	28
MODEL	LENGTH	CAM	TYPE	FINISH		

MODEL	LENGTH	∅A	B	∅C	D	E	CAM*	TYPE	FINISH	/CASE
CBM	100	1 ³ / ₈ (35)	1 (25.4)	1 ⁵ / ₃₂ (29.1)	1 ⁹ / ₁₆ (40)	7/32 (5.7)	A, B	DM, T1	20D, 28	100

IN (MM) (*) LEAVE BLANK WHEN ORDERING DUMMY CYLINDER



MORTISE CYLINDERS

SECURITY HARDWARE

MORTISE CYLINDERS – ZINC

CZM

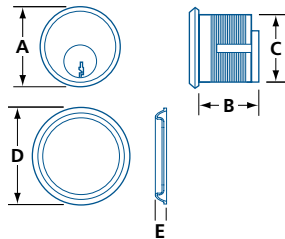

KEY CYLINDER

- Solid zinc construction with aluminum clad face
- 5-pin cylinder
- Trim ring included
- Keyways: Schlage (SC), Yale #9 (Y9) or Weiser (WR)
- Includes 2 keys
- Cams: Adams Rite type (cam A) or Yale type (cam B)

CZM	100	A	-	SC	KD	-	28
MODEL	LENGTH	CAM	KEY	KEYING	FINISH		

MODEL	LENGTH	∅A	B	∅C	D	E	CAM	KEYWAY	KEYING	PINS	FINISH	/CASE
CZM	100	1 3/8 (35)	1 (25.4)	1 5/32 (29.1)	1 9/16 (40)	7/32 (5.7)	A, B	SC, Y9, WR	KA, KA2, KD	5	1B, 26D, 28	100

IN (MM) KA: KEYED ALIKE KA2: KEYED ALIKE, PAIRED CYLINDERS, 50 PAIRS PER CASE KD: KEYED DIFFERENT

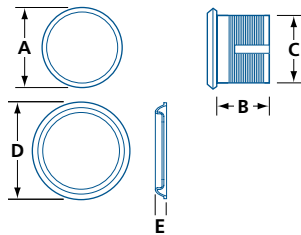

DUMMY CYLINDER

- Solid zinc construction with aluminum clad face
- Trim ring included

CZM	100	-	DM	-	28
MODEL	LENGTH	TYPE	FINISH		

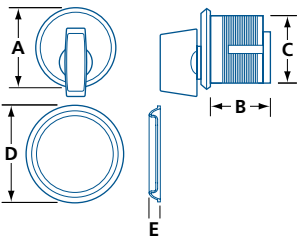

THUMB-TURN CYLINDER

- Solid zinc construction with aluminum clad face
- Trim ring included
- Cams: Adams Rite type (cam A) or Yale type (cam B)

CZM	100	A	-	T1	-	28
MODEL	LENGTH	CAM	TYPE	FINISH		

MODEL	LENGTH	∅A	B	∅C	D	E	CAM*	TYPE	FINISH	/CASE
CZM-DM	100	1 3/8 (35)	7/8 (22.8)	1 5/32 (29.1)	1 9/16 (40)	7/32 (5.7)	A, B	DM, T1	1B, 28	100
CZM-T1	100	1 3/8 (35)	1 (25.4)	1 5/32 (29.1)	1 9/16 (40)	7/32 (5.7)	A, B	DM, T1	1B, 28	100

IN (MM) (*) LEAVE BLANK WHEN ORDERING DUMMY CYLINDER

MORTISE CYLINDERS

SECURITY HARDWARE

Viro MORTISE CYLINDERS



731731

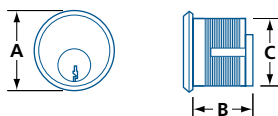

732

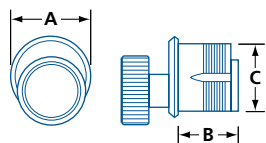

- Solid brass cylinder and trim ring
- 5-pin Viro #015 keyway
- Supplied with 3 nickel-plated brass keys per pair of cylinders
- Supplied with cam A; cam B (#CAM991) available separately
- Packaged and sold in pairs
- Keyed alike in pairs
- Key blank: #303KB015RH

Wide variety of padlocks and specialty locks available – please contact to order or visit www.viro.it for details

MODEL	∅A	B	∅C
731731	1¼	1	1½ ₃₂
732	(31.8)	(25.3)	(29.1)

IN (MM)

MODEL	FINISH	MATERIAL	LENGTH	CAM	KEYWAY	KEYING	/UNIT	/BOX
731731	C3, C15	Brass	1 (25.3)	A	Viro #015	KA2	2	6*
732	C15	Brass	1 (25.3)	A	—	—	1	6

(*) 3 PAIRS



RIM CYLINDERS

SECURITY HARDWARE

RIM CYLINDER

MR

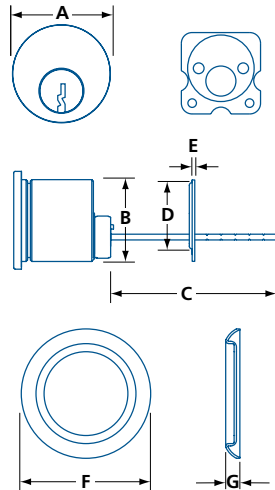

- Solid brass cylinder, trim ring included
- Cylinder length: 118 = 1 1/8" (28.6 mm)
- 6-pin, drilled for Construction Master Key (CMK)
- Keyways: Schlage (SC) or Weiser (WR)
- 2 keys included
- Tailpiece converts between horizontal and vertical positions
- Screw-on retaining cap

MR	118	- WR	KD6	-	26D
MODEL	LENGTH	KEY	KEYING		FINISH

MODEL	øA	øB	C	D	E	F	G
MR	1 3/8 (34.5)	1 5/32 (29.1)	2 7/16 (60)	1 13/64 (31)	3/16 (1.2)	1 13/16 (45.8)	3/16 (5)

IN (MM)

MODEL	LENGTH	CAM	KEYWAY	KEYING*	PINS	FINISH	/CASE
MR	118	—	SC, WR	KD6	6	19, 26D	100

(*) FULL KEYING SERVICES AVAILABLE – PLEASE CONTACT

KD: KEYED DIFFERENT

RIM CYLINDER

CBR

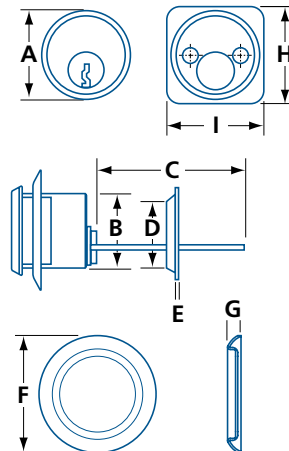
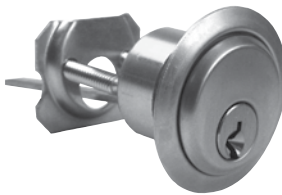

- Solid brass with aluminum clad face, trim ring included
- Cylinder length: 114 = 1 1/4" (32 mm)
- Keyways: 6-pin Schlage (SC) or special order 5-pin Yale #9 (Y9)
- 2 keys included
- Standard tailpiece and mounting hardware

CBR	114	- Y9	KD	-	26D
MODEL	LENGTH	KEY	KEYING		FINISH

MODEL	øA	øB	C	D	E	F	G	H	I
CBR	1 3/8 (34.5)	1 5/32 (29.1)	2 7/16 (62)	1 5/32 (29.4)	1/16 (1.6)	1 9/16 (40)	7/32 (5.7)	1 5/16 (33)	1 5/16 (33)

IN (MM)

MODEL	LENGTH	CAM	KEYWAY	KEYING	PINS	FINISH	/CASE
CBR	114	—	SC, Y9*	KD	6	19, 26D	100

(*) SPECIAL ORDER

KD: KEYED DIFFERENT

RIM CYLINDERS

SECURITY HARDWARE

DUMMY RIM CYLINDER

160

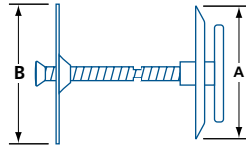

- Solid brass construction
- Covers cylinder hole in doors up to 2¼" (57.2 mm) thick
- Supplied with mounting backplate and 2" (50.8 mm) long break away screw
- Available in brass plated (BP) or satin chrome (C26D) finishes

MODEL	FINISH	øA	øB	/CASE
160	BP, C26D	1 ¹³ / ₁₆ (46)	1 ⁷ / ₈ (48)	300

IN (MM)



CYLINDER TRIM RINGS

SECURITY HARDWARE

CYLINDER TRIM RINGS & GUARDS

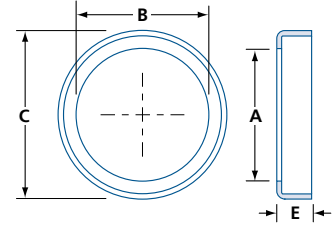

MODEL	FINISH	MATERIAL	∅A	∅B	∅C	D	E	/BOX
811A	C26D, C28	Aluminum	1 ¹³ / ₃₂ (36.0)	1 ⁵ / ₃₂ (29.3)	1 ¹ / ₂ (38.0)	⁷ / ₃₂ (5.5)	—	100
812A	C26D, C28	Aluminum	1 ¹³ / ₃₂ (36.0)	1 ⁵ / ₃₂ (29.3)	1 ⁹ / ₁₆ (39.6)	⁷ / ₃₂ (5.5)	—	100

IN (MM)

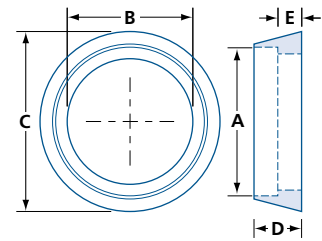
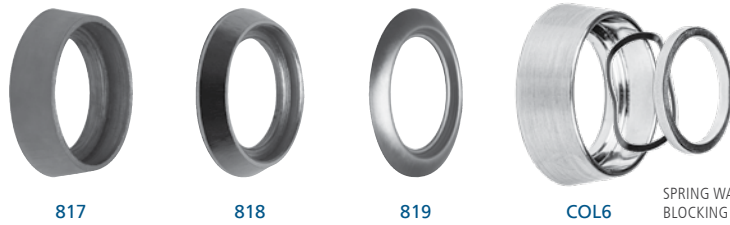

SPRING WASHER AND
BLOCKING RING INCLUDED.

MODEL	FINISH	MATERIAL	∅A	∅B	∅C	D	E	/BOX
817S	C26D	Hardened steel	1 ¹³ / ₃₂ (36.0)	1 ³ / ₁₆ (30.0)	1 ¹¹ / ₁₆ (42.9)	⁷ / ₁₆ (11.4)	⁵ / ₃₂ (4.0)	50
818S	C28, C26D	Hardened steel	1 ¹ / ₂ (37.8)	1 ³ / ₁₆ (30.0)	1 ¹¹ / ₁₆ (42.9)	⁹ / ₃₂ (7.3)	³ / ₁₆ (4.4)	50
819A	C28	Aluminum	1 ¹¹ / ₃₂ (34.0)	1 ⁷ / ₃₂ (31)	1 ⁷ / ₈ (47.6)	¹ / ₈ (3.75)	³ / ₃₂ (2.0)	100
COL6	C26D, C19	Hardened steel	1 ¹³ / ₃₂ (36.0)	1 ³ / ₁₆ (30.0)	1 ⁷ / ₁₆ (36.6)	⁹ / ₁₆ (14.3)	³ / ₁₆ * (4.5*)	100

IN (MM) (*) ³/₁₆" (7.5MM) WITH INCLUDED ¹/₈" (3MM) BLOCKING RING.

ADJUSTABLE CYLINDER TRIM RING

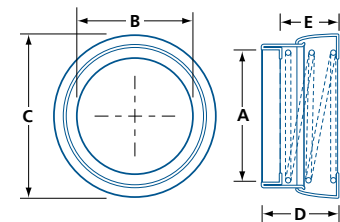

MODEL	FINISH	MATERIAL	∅A	∅B	∅C	D	E	/BOX
814S	C26D, C28	Steel	1 ³ / ₈ (35.0)	1 ³ / ₁₆ (30.0)	2 (50.8)	⁹ / ₁₆ - ⁷ / ₈ (14.3-22.2)	²⁷ / ₆₄ - ⁴⁷ / ₆₄ (10.7-18.6)	250

IN (MM)

CYLINDER TRIM RINGS

SECURITY HARDWARE

BLOCKING RING

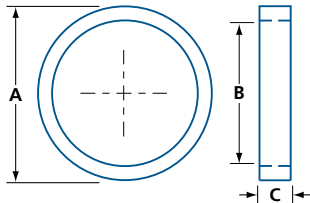

- Solid aluminum blocking ring for 1 $\frac{5}{32}$ " (29 mm) mortise cylinder

MODEL	MATERIAL	$\varnothing A$	$\varnothing B$	C	/BOX
815AC28	Aluminum	1 $\frac{3}{8}$ (35)	1 $\frac{5}{32}$ (29)	$\frac{1}{4}$ (6.4)	100

IN (MM)

SPRING WASHER

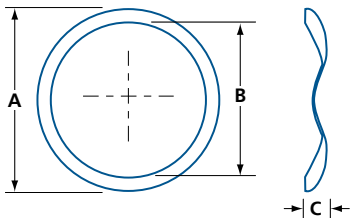

- Stainless steel spring washer for 1 $\frac{5}{32}$ " (29 mm) mortise cylinder

MODEL	MATERIAL	$\varnothing A$	$\varnothing B$	C	/BOX
820S	Stainless steel	1 $\frac{3}{8}$ (35)	1 $\frac{5}{32}$ (29)	$\frac{5}{32}$ (4.1)	500

IN (MM)

MORTISE CYLINDER RING NUT

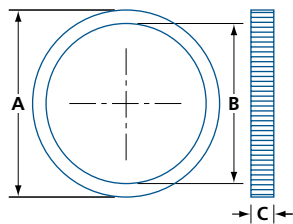

- Solid brass threaded locking ring nut for 1 $\frac{5}{32}$ " (29 mm) mortise cylinder

MODEL	MATERIAL	$\varnothing A$	$\varnothing B$	C	/BOX
2315-2	Brass	1 $\frac{5}{16}$ (33.5)	1 $\frac{1}{8}$ (28.6)	$\frac{5}{32}$ (4.1)	100

IN (MM)



GUARDS & LATCH PROTECTORS

SECURITY HARDWARE

CYLINDER GUARD

5510

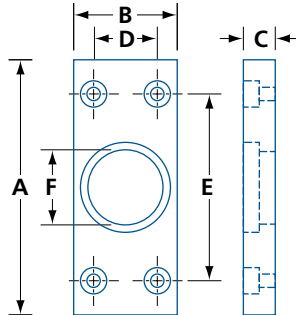

- Heavy aluminum plate
- Mounts to metal door with 4 steel $\frac{3}{16}$ " (4.8 mm) pop rivets (included)
- $\frac{1}{4}$ " (6.4 mm) cylinder recess

MODEL	FINISH	A	B	C	D	E	∅F	/BOX
5510	Aluminum	4 (102)	1 $\frac{5}{8}$ (41.4)	$\frac{1}{2}$ (12.8)	1 (25.5)	3 (76)	1 $\frac{3}{16}$ (30.1)	20

IN (MM)

CYLINDER / LATCH GUARD

LPA

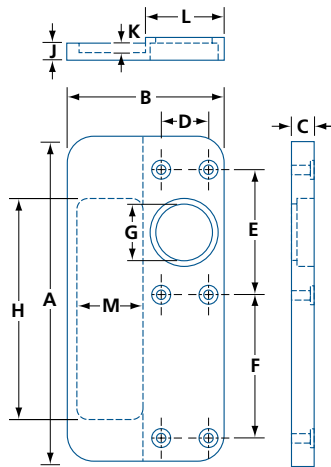

- Solid 6061 aluminum plate
- Handed
- Mounts to metal door with 6 steel $\frac{3}{16}$ " (4.8 mm) pop rivets (included)
- For use on narrow style aluminum doors
- Protects latch, cylinder and strike
- $1\frac{1}{32}$ " (8.7 mm) cylinder recess
- Cylinder spacers included

LPA45C for flush doors

LPA45D for offset doors

LPA45F for offset doors with wide electric strike

MODEL	A	B	C	D	E	F	∅G	H	J	K	L	M
LPA45C	6 $\frac{3}{4}$ (171)	3 $\frac{1}{4}$ (82.5)	$\frac{1}{2}$ (12.7)	1 (25.4)	2 $\frac{19}{32}$ (66)	3 (76)	1 $\frac{3}{16}$ (30)	—	—	—	—	—
LPA45D	6 $\frac{3}{4}$ (171)	3 $\frac{1}{4}$ (82.5)	$\frac{1}{2}$ (12.7)	1 (25.4)	2 $\frac{19}{32}$ (66)	3 (76)	1 $\frac{3}{16}$ (30)	—	$\frac{3}{8}$ (9.5)	—	1 $\frac{5}{8}$ (41)	—
LPA45F	6 $\frac{3}{4}$ (171)	3 $\frac{1}{4}$ (82.5)	$\frac{1}{2}$ (12.7)	1 (25.4)	2 $\frac{19}{32}$ (66)	3 (76)	1 $\frac{3}{16}$ (30)	4 $\frac{3}{4}$ (120)	$\frac{3}{8}$ (9.5)	$\frac{9}{32}$ (7.1)	1 $\frac{5}{8}$ (41)	1 $\frac{1}{2}$ (38.1)

IN (MM)

GUARDS & LATCH PROTECTORS

SECURITY HARDWARE

LATCH PROTECTORS



- Unit covers the latch area of the door, thereby providing added protection from burglaries, vandalism or abuse
- For use with maximum 2½" (63.5 mm) diameter mortise or 3¾" (92.1 mm) cylindrical lock
- Made of heavy gauge steel
- 311P and 311LP are supplied with security pin to prevent separation of the door and frame
- Individually packed and supplied with carriage bolts and nuts

#311BOLTKIT Bolt kit for exterior doors with weatherstripping

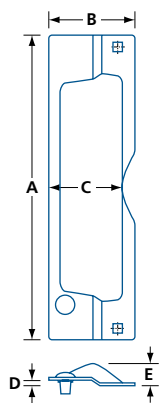

MODEL	FINISH	A	B	C	D	E	/CASE
307	C28	7	3	—	$\frac{9}{32}$ (7)	$\frac{3}{4}$ (19)	40
307L		(177.7)	(76.3)	$2\frac{9}{16}$ (65.0)			
311P	C28	$10\frac{7}{8}$ (276.5)	$3\frac{3}{32}$ (78.2)	—	$\frac{9}{32}$ (7)	$\frac{3}{4}$ (19)	40
311S				$2\frac{7}{8}$ (73.0)			
311LP				$2\frac{5}{8}$ (67.0)			

IN (MM)



PROFILE CYLINDERS

SECURITY HARDWARE

Viro DOUBLE CYLINDER

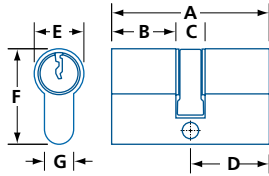

- Solid extruded tear-drop profile cylinder for sliding door mortise locks
- 5-pin Viro #062 keyway
- 3 keys and 3" (76mm) fastening screw included
- Escutcheon plate #721 sold separately; 2 required per cylinder

Wide variety of padlocks and specialty locks available – please contact to order or visit www.viro.it for details



721BP Brass Plated
721NP Nickel Plated

- Supplied with mounting screws



KB062 Nickel Plated
Keyblank

9203	KD	C15
MODEL	KEYING	FINISH

MODEL	NO.OF PINS	KEYWAY	KEYING	FINISH	A	B	C	D	E	F	G	/BOX
9203	5	Viro #062	KD	C3, C15	2 ³ / ₈ (60)	1 (25)	1 ³ / ₃₂ (10.1)	1 ³ / ₁₆ (30)	2 ¹ / ₃₂ (17)	1 ⁵ / ₁₆ (33)	3 ⁸ / ₈ (10)	10
92015	5	Viro #062	KD	C3	2 ³ / ₄ (70)	1 ³ / ₁₆ (30)	1 ³ / ₃₂ (10.1)	1 ³ / ₈ (35)	2 ¹ / ₃₂ (17)	1 ⁵ / ₁₆ (33)	3 ⁸ / ₈ (10)	10
921	5	Viro #062	KD	C3, C15	2 ¹ / ₈ (54)	7 ⁸ / ₈ (22.2)	3 ⁸ / ₈ (9.5)	1 ¹ / ₁₆ (27)	2 ¹ / ₃₂ (17)	1 ⁵ / ₁₆ (33)	3 ⁸ / ₈ (10)	10

IN (MM)

Viro THUMBTURN CYLINDER

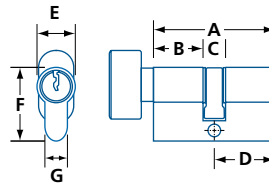

- Solid extruded tear-drop profile cylinder for sliding door mortise locks
- Brass knob, removable, easy to grip, with rounded edges
- 5-pin Viro #015 keyway
- 3 keys and fastening screw included
- Escutcheon plate #721 sold separately; 2 required per cylinder
- Viro keyblank #303KB available

Wide variety of padlocks and specialty locks available – please contact to order or visit www.viro.it for details



721BP Brass Plated
721NP Nickel Plated

- Supplied with mounting screws



303KB Nickel Plated
Keyblank

7407	KD	C15
MODEL	KEYING	FINISH

MODEL	NO.OF PINS	KEYWAY	KEYING	FINISH	A	B	C	D	E	F	G	/BOX
7407	5	Viro #015	KD	C3, C15	2 ³ / ₄ (70)	1 ³ / ₁₆ (30)	1 ³ / ₃₂ (10.1)	1 ³ / ₈ (35)	2 ¹ / ₃₂ (17)	1 ⁵ / ₁₆ (33)	3 ⁸ / ₈ (10)	10

IN (MM)

DOOR VIEWERS

SECURITY HARDWARE

DOOR VIEWERS



B02

- Solid brass door viewer
- Acrylic optical lens
- Individually boxed

MODEL	FINISH	DOOR THICKNESS	ø BORE	FIRE RATING	VISION ANGLE	/BOX
B02	C26D		12mm	—	160°	25
B03	C3, C26D	1 $\frac{3}{8}$ –2 $\frac{1}{4}$ (35–57)	14mm	—	180°	25
B04	C3, C26D		16mm	—	200°	10

IN (MM)



DV160



DV180, DV200

- Solid brass door viewer
- cULus 20 minute fire rating for labelled fire doors
- Polished glass and acrylic optical lenses
- Individually boxed

MODEL	FINISH	DOOR THICKNESS	ø BORE	FIRE RATING	VISION ANGLE	/BOX
DV160	26, 26D	1 $\frac{3}{8}$ –2 (35–51)	12mm	20 min	160°	25
DV180	26D, 19		14mm	20 min	180°	25
DV200	26D	1 $\frac{3}{8}$ –2 $\frac{1}{4}$ (35–57)	14mm	20 min	200°	10

IN (MM)



DV1012SRG



DV1012BRQ



DV1012BLQ

- Solid brass door viewer
- cULus 90 minute fire rating for labelled fire doors
- Polished glass and quartz lens
- Individually boxed

MODEL	FINISH	DOOR THICKNESS	ø BORE	FIRE RATING	VISION ANGLE	/BOX
DV1012SRG	15, 19, 26D	1 $\frac{1}{16}$ –1 $\frac{1}{16}$ (17.5–27)	12mm	90min	160°	25
DV1012BRQ	26	1 $\frac{3}{8}$ –2 (35–51)	12mm	90min	160°	42
DV1012BLQ	19, 26		12mm	90min	200°	25
DV1014BLQ	C15, C19, C26, 26D	1 $\frac{3}{4}$ –2 $\frac{1}{4}$ (44.5–57)	14mm	90min	200°	25

IN (MM)

DOOR VIEWERS

SECURITY HARDWARE

REVOLVING DOOR VIEWER

511

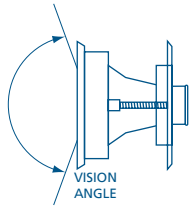

- Revolving door viewer
- Stamped brass components
- Crystal optical glass lenses
- Individually boxed
- 511 KTD Extension kit available for 2" (50.3 mm) thick doors

MODEL	FINISH	DOOR THICKNESS	Ø BORE	FIRE RATING	VISION ANGLE	/UNIT
511	C3, C26D, C19	1 ³ / ₈ – 1 ³ / ₄ * (35–44)	2 ³ / ₈ (60.3)	—	140°	1

IN (MM) *UP TO 2" (50.3 MM) WITH EXTENSION KIT

REFLEX DOOR VIEWER

DS1000, DS2000

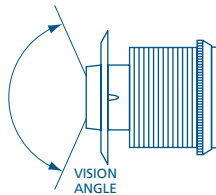

- Reflex door viewer with 2" (50.3 mm) screen
- Warnock Hersey listed for 20 minutes fire rated location when used with firestop sealant (not supplied) on a wood composite fire door
- Precision optics, no image distortion, clear viewing up to 7 feet away
- Individually carded

MODEL	FINISH	MATERIAL	DOOR THICKNESS	Ø BORE	FIRE RATING	VISION ANGLE	/UNIT
DS1000	BL, BR, GR	ABS plastic	1 ³ / ₈ –2 (35–51)	2 ³ / ₈ (60.3)	20 min	132°	1
DS2000	SL, BL	Aluminum					

IN (MM)

DOOR VIEWER – LARGE

DS300



DS300CHR-COVER

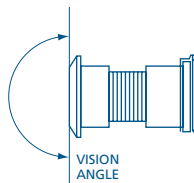

- Zinc die cast door viewer
- Polished glass optical lens
- Viewer is intended for use with classified fire door rated up to and including 90 minutes
- Detachable lens cover is included
- Individually boxed
- Replacement lens cover: #DS300CHR-COVER

MODEL	FINISH	DOOR THICKNESS	Ø BORE	FIRE RATING	VISION ANGLE	/BOX
DS300	BP, CHR	1 ³ / ₈ –2 (35–51)	3 ¹ / ₃₂ (24.5)	90 min	180°	15

IN (MM)



DOOR GUARDS & CHAINS

SECURITY HARDWARE

PRIVACY DOOR GUARD

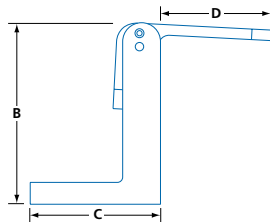
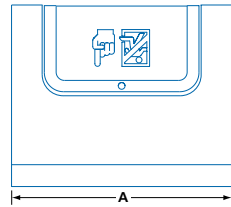

- Listed for use on fire rated openings (3 hrs)
- ADA Compliant
- Zinc die-cast body and latch
- Allows door to open 4°
- Silicone pads protect door and reduce noise
- Easy to install and operate
- Includes sheet-metal screws, machine screws and rivet nuts
- Rivet nut tool not included
- Non-listed model available (#PDG)

MODEL	FINISH	A	B	C	D	/BOX
PDGF	19, 15,	2 ⁵ / ₈	2 ⁵ / ₃₂	1 ⁹ / ₁₆	1 ⁵ / ₁₆	10
PDG	26D	(66.6)	(54.7)	(39)	(33)	

IN (MM)

DOOR GUARD

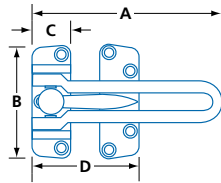
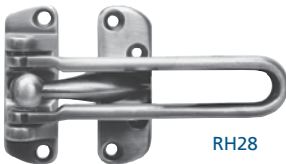

- High security zinc alloy door guard, supplied with mounting screws
- RH28 finish: antique brass, antique bronze, antique nickel, polished brass, polished chrome, satin chrome or satin nickel
- Protective edge plates for door guard RH28EP, 9/16 x 1 x 1 3/16" (14.3 x 25.4 x 30 mm) sold separately
- Finish: RH28EP: aluminum(C28), polished brass (C3)
AP34: satin chrome (626)



MODEL	FINISH	A	B	C	D	/BOX
RH28	AB, AN, BP, C11P, CHR, SC, SN	4 ¹ / ₄ (108)	2 ⁷ / ₁₆ (62)	1 ³ / ₁₆ (21)	2 ⁵ / ₈ (67)	10

IN (MM)

DOOR CHAIN

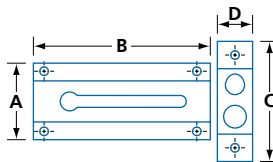
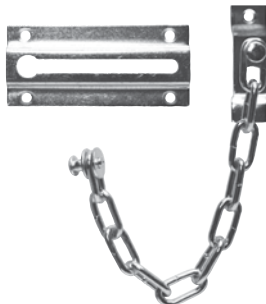

- Economical model plated steel chain guard with welded steel chain in poly bag
- Supplied with mounting screws
- Nickel plated (NP) finish

MODEL	CHAIN	A	B	C	D	/BOX
232.620NP	8 (203)	1 ⁷ / ₁₆ (36)	3 ³ / ₈ (86.0)	2 ⁵ / ₁₆ (58)	1 ¹ / ₁₆ (17.1)	10

IN (MM)

RIM LOCKS

SECURITY HARDWARE

NIGHT LATCH

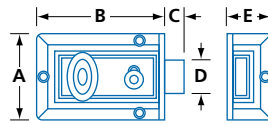
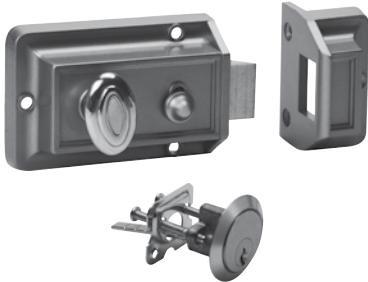

- Zinc alloy case and strike
- Solid brass bolt and deadlatch button
- Solid brass 5-pin Yale #9 keyway rim cylinder and trim ring included
- $\frac{9}{16}$ " (14.4 mm) latch throw
- Cylinder screws for up to $2\frac{1}{4}$ " (57 mm) door thickness
- Supplied with mounting screws
- Finish: painted gold color

MODEL	A	B	C	D	E	/BOX
0508-1	$2\frac{1}{2}$ (63)	$3\frac{5}{8}$ (91.9)	$\frac{9}{16}$ (14.4)	$\frac{15}{16}$ (24.1)	$1\frac{1}{4}$ (31.9)	12

IN (MM)

JIMMY PROOF DEADLOCK

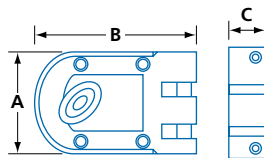
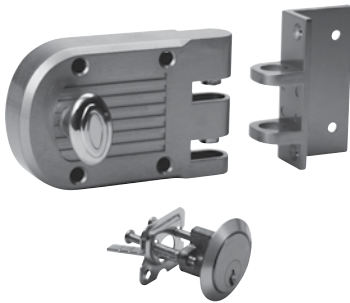

- Zinc alloy case and keeper
- Brass plated reinforced steel vertical bolts
- Solid brass 5-pin Yale #9 keyway rim cylinder and trim ring included
- Available keyed alike (KA) or keyed different (KD)
- Cylinder screws for up to $2\frac{1}{4}$ " (57 mm) door thickness
- Supplied with mounting screws
- Finish: painted gold color

MODEL	A	B	C	/BOX
0515-1	$2\frac{25}{32}$ (70.5)	$4\frac{13}{32}$ (112.0)	1 (25.5)	12

IN (MM)

JIMMY PROOF DEADLOCK – DOUBLE CYLINDER

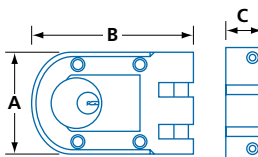
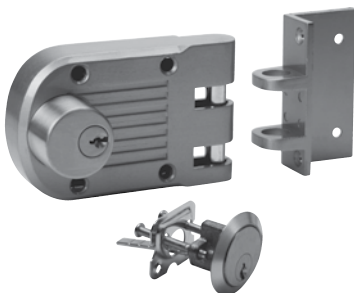

- Zinc alloy case and keeper
- Brass plated reinforced steel vertical bolts
- 2 solid brass 5-pin Yale #9 keyway rim cylinders and trim rings included
- Cylinder screws for up to $2\frac{1}{4}$ " (57 mm) door thickness
- Supplied with mounting screws
- Finish: painted gold color

MODEL	A	B	C	/BOX
0515A-1	$2\frac{25}{32}$ (70.5)	$4\frac{13}{32}$ (112.0)	1 (25.5)	12

IN (MM)

DOOR PROTECTION

SECURITY HARDWARE

WRAP AROUND PLATES

WP4B, WP9B, WDC12B, WDCP12B



WP9



WDC12



WDCP12

- For cylindrical locks with 2 1/8" (54mm) bore hole
- For 1 3/4" (45mm) door thickness
- 22 gauge stainless steel
- Latch faceplate recess fits:
1 1/8 x 2 1/4" (28.5 x 57mm) latches
- Mounting screws included

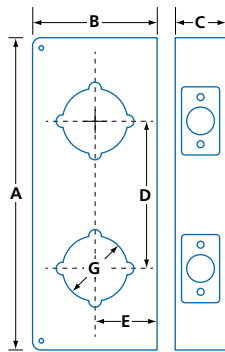

MODEL	A	B	C	D	E	∅G
WP4BA-32D	4 1/2 (114.5)	4 (102)	1 3/4 (45)	—	2 3/8 (60)	2 1/8 (54)
WP4BB-32D		4 1/4 (108)			2 3/4 (70)	
WP9BA-32D	9 (229)	4 (102)	1 3/4 (45)	—	2 3/8 (60)	2 1/8 (54)
WP9BB-32D		4 1/4 (108)			2 3/4 (70)	
WDC12BA-32D	12 (305)	4 (102)	1 3/4 (45)	5 1/2 (140)	2 3/8 (60)	2 1/8 (54)
WDC12BB-32D		4 1/4 (108)			2 3/4 (70)	
WDCP12BA-32D	12 (305)	4 (102)	1 3/4 (45)	5 1/2 (140)	2 3/8 (60)	2 1/8 (54)
WDCP12BB-32D		4 1/4 (108)			2 3/4 (70)	

IN (MM)

CAM LOCKS

SECURITY HARDWARE

Viro SOLID BRASS CAM LOCK

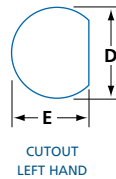
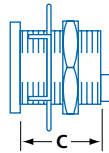
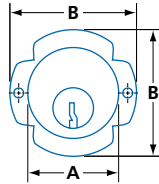

- Solid brass, fully threaded, pin tumbler cylinder
- Handed models supplied RH, LH available on special order
- Milled on one side to prevent rotation (single "D")
- 1012 and 1013 come with center plug position
- Universal use, easy to install on wood or metal cabinet and mailbox
- Supplied with 4 prong steel washer, securing nut, cam screw and 2 keys
- Custom keyed systems available
- Supplied with cam, please specify cam model
- Finish: natural brass (C3) or nickel plated (C15)

1053	KD	C15
MODEL	KEYING	FINISH

Wide variety of padlocks and specialty locks available – please contact to order or visit www.viro.it for details



301KB for 1012 & 1052 cam locks
302KB for 1003, 1004, 1005, 1013, 1053, 1054, 1055 & 1056 cam locks
 All key blanks are nickel plated brass

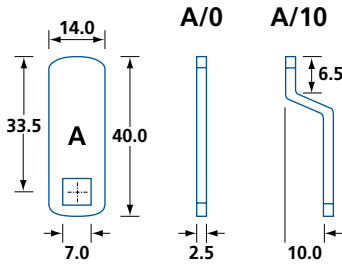

CAM dimensions are in millimetres.

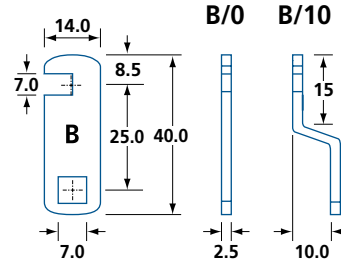

MODEL	DEGREE OF TURN	PLUG POSITION	KEY REMOVAL	KEYWAY	HANDING	øA	øB	C	D	E	/BOX
1003	90°	Vertically offset	Locked	013	Right hand	15/16 (24.0)	1 9/32 (32.8)	1 3/16 (21.0)	2 5/32 (20.0)	2 3/32 (18.3)	12
1004	90°	Vertically offset	Locked	013	Right hand	15/16 (24.0)	1 9/32 (32.8)	1 1/32 (26.0)	2 5/32 (20.0)	2 3/32 (18.3)	12
1005	90°	Vertically offset	Locked	013	Right hand	15/16 (24.0)	1 9/32 (32.8)	1 7/32 (31.0)	2 5/32 (20.0)	2 3/32 (18.3)	12
1012	90°	Centered	Locked or Unlocked	011	Non-handed*	15/16 (24.0)	1 9/32 (32.8)	1 1/16 (17.5)	2 5/32 (20.0)	2 3/32 (18.3)	12
1013	90°	Centered	Locked or Unlocked	013	Non-handed*	15/16 (24.0)	1 9/32 (32.8)	1 3/16 (21.0)	2 5/32 (20.0)	2 3/32 (18.3)	12
1052	180°	Vertically offset	Locked	011	Non-handed*	15/16 (24.0)	1 9/32 (32.8)	1 1/16 (17.5)	2 5/32 (20.0)	2 3/32 (18.3)	12
1053	180°	Vertically offset	Locked	013	Non-handed*	15/16 (24.0)	1 9/32 (32.8)	1 3/16 (21.0)	2 5/32 (20.0)	2 3/32 (18.3)	12
1054	180°	Vertically offset	Locked	013	Non-handed*	15/16 (24.0)	1 9/32 (32.8)	1 1/32 (26.0)	2 5/32 (20.0)	2 3/32 (18.3)	12
1055	180°	Vertically offset	Locked	013	Non-handed*	15/16 (24.0)	1 9/32 (32.8)	1 7/32 (31.0)	2 5/32 (20.0)	2 3/32 (18.3)	12
1056	180°	Vertically offset	Locked	013	Non-handed*	15/16 (24.0)	1 9/32 (32.8)	1 3/8 (35.0)	2 5/32 (20.0)	2 3/32 (18.3)	12

IN (MM) (*) CONFIGURED FOR RIGHT-HAND USE, CAN BE CONVERTED TO LEFT-HAND

CAM LOCKS

SECURITY HARDWARE

MAILBOX CAM LOCK



S4103

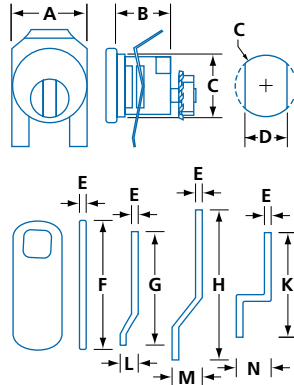

- Nickel plated zinc alloy body with clip mounting
- Panel thickness: $\frac{1}{16}$ " to $\frac{3}{16}$ " (1.5 to 4.5 mm)
- Keyable 4-pin tumbler cylinder with brass pins, key only retractable when in locked position
- 2 keys included
- Left turning key
- 4 different cams included
- Packaged in a poly bag
- Finish: nickel plated



S4103KB

- Nickel plated brass key blank

MODEL	øA	B	øC*	D*	E	F	G	H	K	L	M	N	/BOX
S4103	$\frac{7}{8}$ (22.2)	$\frac{21}{32}$ (16.7)	$\frac{3}{4}$ (19)	$\frac{5}{8}$ (16)	$\frac{9}{64}$ (2.0)	$1\frac{17}{32}$ (38.5)	$1\frac{3}{16}$ (30)	$1\frac{13}{16}$ (46)	$\frac{17}{32}$ (31.2)	$\frac{1}{4}$ (6.3)	$\frac{11}{32}$ (8.7)	$\frac{13}{32}$ (10.4)	10

IN (MM) *FOR HOLE IN PANEL

MAILBOX CAM LOCK – WITH KEYHOLE SHUTTER



S4103C

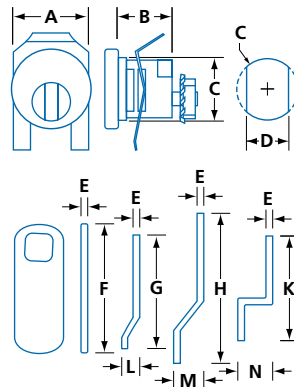

- Nickel plated zinc alloy body with clip mounting
- Panel thickness: $\frac{1}{16}$ " to $\frac{3}{16}$ " (1.5 to 4.5 mm)
- Keyable 4-pin tumbler cylinder with brass pins, key only retractable when in locked position
- 2 keys included
- Right turning key
- 4 different cams included
- Includes keyhole shutter - slide shutter to the right with the tip of the key to enter key
- Packaged in a poly bag
- Finish: nickel plated



S4103KB

- Nickel plated brass key blank

MODEL	øA	B	øC*	D*	E	F	G	H	K	L	M	N	/BOX
S4103C	1 (25.4)	$\frac{21}{32}$ (16.7)	$\frac{3}{4}$ (19)	$\frac{5}{8}$ (16)	$\frac{9}{64}$ (2.0)	$1\frac{17}{32}$ (38.5)	$1\frac{3}{16}$ (30)	$1\frac{13}{16}$ (46)	$\frac{17}{32}$ (31.2)	$\frac{1}{4}$ (6.3)	$\frac{11}{32}$ (8.7)	$\frac{13}{32}$ (10.4)	10

IN (MM) *FOR HOLE IN PANEL



KEY CABINETS

SECURITY HARDWARE

KEY CABINET

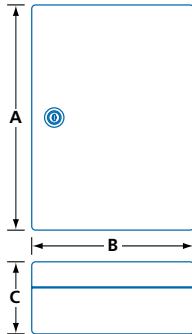

- Sturdy all metal construction with rounded corners allow for greater strength and durability
- Heavy gauge seamless steel
- Scratch-resistant light grey paint
- Rust proof
- Complete with key hooks, key tags, 2 screws and plugs
- Pre-slotted mounting holes
- Lockable cabinet standard KD version, KA version available with purchase of replacement CL50 keyed alike cam locks (see below), 2 keys per cabinet / cam lock supplied



CL50

- Replacement cam lock for 50 series key cabinet
- Key is removable in locked or unlocked position with 90° angle rotation
- Suitable for panel thickness up to $\frac{3}{32}$ " (2.4 mm)
- Available keying KA1, KA2, KD



KB50 / KB50-2

- 4 pins
- Nickel plated brass key blank
- Available keyway 101 & 102

MODEL	NUMBER OF KEY HOOKS	A	B	C	/CASE
50-20	20	$9\frac{7}{8}$ (250)	$7\frac{1}{8}$ (180)	$3\frac{1}{8}$ (80.5)	12
50-40	40				8
50-50	50	$11\frac{13}{16}$ (300)	$9\frac{1}{8}$ (230)	$3\frac{3}{16}$ (90)	6
50-70	70				8
50-105	105				
50-120	120	$14\frac{3}{16}$ (360)	$9\frac{7}{8}$ (250)	$4\frac{3}{8}$ (110)	6
50-140	140				

IN (MM)

EMERGENCY BOX

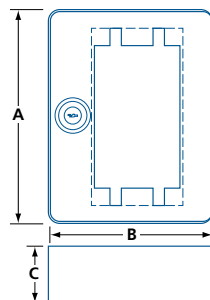

- Sturdy heavy gauge steel construction
- Scratch resistant, painted red
- Single key hook
- Includes steel hammer-rod and cord
- Lockable cabinet; 2 keys supplied
- Pre-drilled mounting holes
- Includes wood screws and plastic anchors
- #EB02G: Replacement glass

MODEL	A	B	C	/CASE
EB-02	$5\frac{29}{32}$ (150)	$4\frac{17}{32}$ (115)	$1\frac{1}{16}$ (40)	25

IN (MM)

KEY RINGS

SECURITY HARDWARE

SPLIT KEY RINGS



20600 / TKR



P412

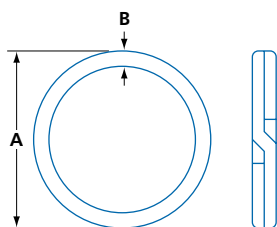

- Strong tempered spring steel split ring (20600 and TKR series)
- Strong tempered steel light-duty split ring (P412 series)
- Finish: nickel plated

MODEL	∅A	B	/ BOX ¹	/ CASE ²
20616	5/8 (16)	3/64 (1.2)	100	500
20619	3/4 (19)	1/16 (1.6)	100	1000
20623	7/8 (22)	1/16 (1.6)	100	1000
20625	1 (25)	1/16 (1.6)	100	1000
20628	1 1/8 (28.3)	1/16 (1.6)	100	500
20632	1 9/32 (32.2)	5/64 (2.0)	100	500
20635	1 3/8 (35.2)	5/64 (2.0)	100	500
20638	1 1/2 (38)	5/64 (2.0)	100	500
20645	1 3/4 (45)	3/32 (2.4)	50	400
20651	2 (51)	3/32 (2.4)	50	200
TKR16	2 3/16 (55)	3/32 (2.4)	—	50
TKR24	3 (76)	1/8 (3.2)	—	25
P412A	5/8 (16)	1/16 (1.6)	10,000	40,000
P412B	1 (25)	1/16 (1.6)	1,000	20,000

IN (MM) (1) UNITS PER BAG (2) UNITS PER CASE

PULL-APART KEY RING

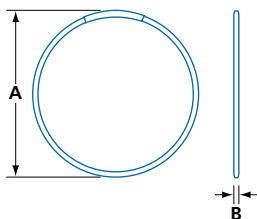

- Pull-apart tempered steel key ring
- Finish: nickel plated

MODEL	∅A	B	/ BOX
PAR3	3 3/4 (95)	1/8 (3.1)	25
PAR4	5 (127)	1/8 (3.1)	25
PAR6	6 (152)	1/8 (3.1)	25

IN (MM)

HOOK KEY RING

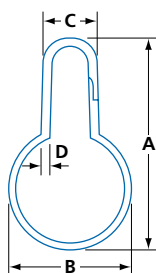

- Tempered steel hook key ring

MODEL	A	∅B	C	D	/ BOX
CP4	2 11/16 (68.6)	1 1/16 (39.7)	11/16 (17.6)	1/8 (3)	100

IN (MM)



KEY RINGS & TAGS

SECURITY HARDWARE

keyline EASY-JOIN KEY RING

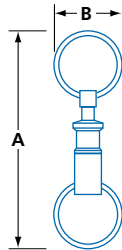

- Easy-join key ring with 2 tempered steel spring split rings and solid brass coupling
- Finish: nickel plated
- Retail card display with 12 key rings
- Not sold individually

MODEL	A	øB	/BOX
D603B	3 ¹ / ₈ (80)	1 (25.4)	120

IN (MM)

keyline KEY TAG WITH SPLIT RING

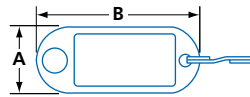

- Coloured plastic label holder with split ring
- H8036: 100 pieces per box
- Available colors: black, blue, light green, orange, purple, red and yellow
- Display box also available as H8036STV200 with 200 pieces of 8 different colors: black, blue, light blue, light green, orange, purple, red and yellow



H8036STV200

MODEL	A	B	/BOX
H8036	7 ⁷ / ₈ (21.5)	2 (51.0)	100
H8036STV200	7 ⁷ / ₈ (21.5)	2 (51.0)	200

IN (MM)

keyline KEY TAG WITH SPLIT RING

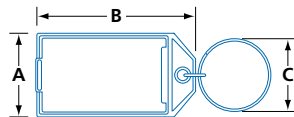

- Durable key tag with split ring
- Made from polypropylene
- Open and close flap with identification paper insert
- Available colors: blue, clear, green, magenta, orange, purple, red, and yellow

MODEL	A	B	øC	/BOX
H8040	1 ⁵ / ₃₂ (29.5)	2 ⁹ / ₃₂ (57.8)	1 (25.4)	100

IN (MM)

KEY RINGS & TAGS

SECURITY HARDWARE

BRASS KEY TAG

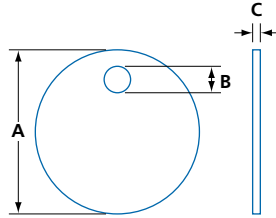

- Solid polished brass tag
- For engraving
- 1¼" (31.8 mm) diameter
- 100 pieces per poly bag

MODEL	øA	B	C	/BOX
104.120	1¼ (31.8)	⅜ (5.0)	⅛ (1.0)	500

IN (MM)



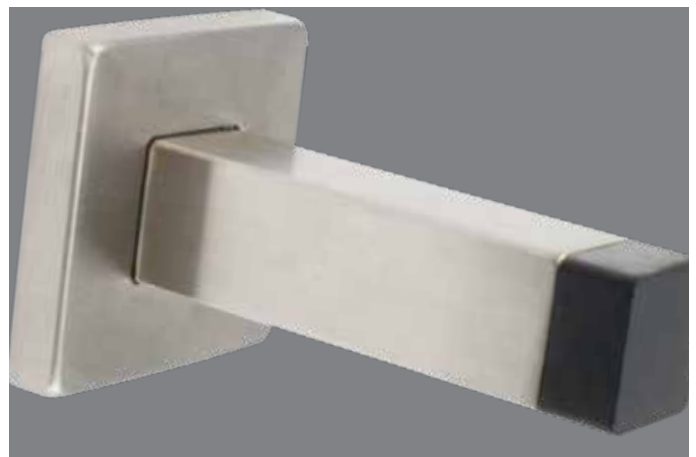

TABLE OF CONTENTS GENERAL HARDWARE

Finish Guide.....	ii
Abbreviation Guide.....	iii

PULL HANDLES & PLATES

Door Pulls	06.010
Aluminum Door Pulls	06.023
Flush Pulls	06.025
Edge Pulls	06.030
Pulls, Multi-purpose	06.040
Door Pulls & Plates	06.050
Push & Kick Plates.....	06.060
Kick, Push & Back Plates.....	06.061

DOOR STOPS & HOLDERS

Floor Stops.....	06.110
Wall Stops	06.120
Roller Bumpers.....	06.125
Hinge Pin Stops.....	06.130
Door Stops with Holder.....	06.140
Door Holders	06.150
Check Chains.....	06.160

DOOR ACCESSORIES

Mail Slots.....	06.200
Signage	06.220
Weather Stripping and Gasketing	06.250

BOLTS & HASPS

Flush Bolts	06.300
Surface Bolts.....	06.320
Tower & Barrel Bolts	06.330
Padbolts & Gate Latches	06.340
Safety Hasps	06.350

TRIMMER HARDWARE

Closet Hardware	06.510
Wardrobe Hooks.....	06.520
Handrail Brackets.....	06.530
Door Catches & Latches	06.540

LAVATORY HARDWARE

Lavatory Partition	06.600
Bath Hardware.....	06.610

CABINET HARDWARE

Magnetic Catches	06.700
Ball & Roller Catches	06.710
Reinforcement Hardware	06.740

SLIDING HARDWARE





Sliding Door Hardware	06.810
By-Pass Door Hardware.....	06.820
Bi-Fold Door Hardware	06.830
Sliding Tracks.....	06.840
Accessories	06.850



WINDOW HARDWARE





Window Catches & Latches.....	06.900
Window Hardware, Cremona	06.910







GENERAL HARDWARE FINISH GUIDE





				
PRIME COATED	BLACK JAPANED / LACQ.	MATTE BLACK LACQUER	ZINC PLATED	YELLOW ZINC PLATED
CODE CP	C1B, KJ	C1D	C2G, ZP	C2GY, YZ
BHMA* 600	601	693	603	

				
POLISHED BRASS	MIRROR POLISHED BRASS	SATIN BRASS	ANTIQUE BRASS	SATIN BRONZE
CODE BP, BP032, C3, 3	C3M, 3M	C4, 4, SDB	AB, C5, 5	C10, 10
BHMA* 605, 632		606, 633	609, 638	612, 639

				
OIL RUBBED BRONZE	POLISHED NICKEL	SATIN NICKEL	ANTIQUE NICKEL	MATTE BLACK
CODE C10B, 10B	NP, C14, 14	SDN, SN, C15, 15	AN, C15A, 15A	C19, 19
BHMA* 613, 640	645	619, 646	620, 647	622, 631

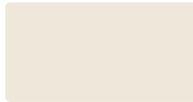
				
DARK BRONZE	POLISHED CHROME	SATIN CHROME	POLISHED STAINLESS STEEL	SATIN STAINLESS STEEL
CODE BLR, DU, C20D, 20D	CHR, C26, 26	SC, C26D, 26D	C32, 32	SS, ST, C32D, 32D
BHMA* 650, 690, 695	625, 651	626, 652	629	630

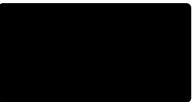
	
ALUMINUM	PLAIN STEEL, NO FINISH
CODE AL, C28, 28	PS
BHMA* 628, 689	

				
ALMOND WHITE	LIGHT BRONZE	EPOXY BLACK	EPOXY WHITE	SATIN WHITE
CODE ALMOND, AW	BZ	EXB	EXW	WSILK
BHMA*				

			
WHITE	BROWN	SILVER PAINT	GOLD PAINT
CODE WH, WHITE	B	SL	GD
BHMA*			

ALL FINISHES IMAGES ABOVE ARE PHOTOGRAPHIC OR COLOUR APPROXIMATIONS, DELIVERED PRODUCT MAY VARY IN COMPARISON OR BETWEEN ORDERS/BATCHES. OTHER FINISHES AVAILABLE—PLEASE CONTACT.
 (*) EQUIVALENT; CODES DIFFER DEPENDING ON BASE MATERIAL AND/OR FINISH PROCESS.

GENERAL HARDWARE ABBREVIATION GUIDE

GENERAL

BS	Backset
DIA, \varnothing	Diameter
KG	Kilograms
LBS	Pounds
LH	Left hand
LHR	Left hand reversed
MAX	Maximum
MIN	Minimum
N/A, —	Not applicable / Not available
QTY	Quantity (usually followed by notes)
RH	Right hand
RHR	Right hand reversed
SQ, \square	Square
WT	Weight
/UNIT	Number of items per basic unit of sale (bagged or boxed)
/BOX, /BAG	Number of UNITS found in an inner carton or bag
/CASE	Number of BOXES or UNITS found in an outer (shipping) carton

LEGEND



Tested to Canadian and/or American safety and performance standards by Underwriters Laboratories® (UL).



DOOR PULLS

GENERAL HARDWARE

DOREX 19R-E SERIES

LADDER PULLS, ROUND, 1 1/4" DIAMETER



1 1/4"
32 mm
Diameter (E)



Single pulls are thru-bolt mounted with round end-caps

APPLICATIONS

- For wood or metal doors 1 3/8–2 1/4" (35–57 mm) thick
- For glass doors 5/16–1/2" (8–13 mm) thick

FEATURES

- 304 Stainless steel
- Available in paired or single pulls
- Single pulls are thru-bolt mounted with round end-caps
- All necessary mounting hardware included
- Matching washers for different finishes included
- Packaged in an eco-friendly, fully recyclable, box



630
SATIN STAINLESS
STEEL



19
MATTE BLACK

SELECTION GUIDE

SERIES	LENGTH [†]	DIAMETER	TYPE	FINISH	DESCRIPTION
19R	24	E	B	630	Ladder Pull, 1 1/4" (32 mm) Round, 24" Center-to-Center, Back-to-Back, Satin Stainless Steel
	12, 24, 36 48, 60, 72	E 1-1/4 (32)	B Back-to-Back S Single	630 Satin Stainless Steel 19 Matte black	

IN (MM), (†) CENTER-TO-CENTER.

NOT ALL COMBINATIONS OF STANDARD LENGTHS, TYPES & FINISHES ARE STOCKED. PLEASE REFER TO PRICE LIST OR CONTACT CANAROPA SALES AND SERVICE FOR DETAILS.

DIMENSIONS

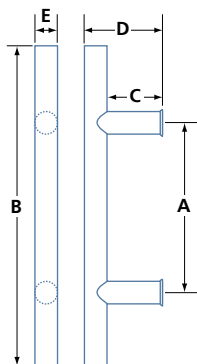

MODEL	A CENTER-TO-CENTER	B TOTAL LENGTH	C POSTS	D PROJECTION	E DIAMETER
19R12	12 (305)	24 (610)	2 7/16 (62)	3 11/16 (94)	1 1/4 (32)
19R24	24 (610)	36 (915)	2 7/16 (62)	3 11/16 (94)	1 1/4 (32)
19R36	36 (915)	48 (1220)	2 7/16 (62)	3 11/16 (94)	1 1/4 (32)
19R48	48 (1220)	60 (1524)	2 7/16 (62)	3 11/16 (94)	1 1/4 (32)
19R60	60 (1524)	72 (1829)	2 7/16 (62)	3 11/16 (94)	1 1/4 (32)
19R72	72 (1829)	84 (2134)	2 7/16 (62)	3 11/16 (94)	1 1/4 (32)

IN (MM)

DOOR PULLS

GENERAL HARDWARE

DOREX 19R-E45 SERIES

LADDER PULLS, ROUND, 1 1/4" DIAMETER, OFFSET POSTS



APPLICATIONS

- For wood or metal doors 1 3/8–2 1/4" (35–57 mm) thick
- For glass doors 5/16–1/2" (8–13 mm) thick

FEATURES

- 304 Stainless steel
- Available in paired or single pulls
- Pull is offset for better functionality and aesthetics
- Simplified Stock Management: Convert back-to-back pairs to singles, and vice-versa (kit sold separately)
- Single pulls are thru-bolt mounted with round end-caps
- All necessary mounting hardware included
- Matching washers for different finishes included
- Offset clearance 2 25/32" (70.6 mm)

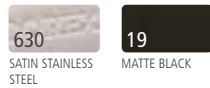

SELECTION GUIDE

SERIES	LENGTH†	DIAMETER	TYPE	OPTION	FINISH	DESCRIPTION
19R	24	E	B	45	630	Ladder Pull, 1 1/4" (32 mm) Round, 24" Center-to-Center, Back-to-Back, 45°, Satin Stainless Steel
	12, 24, 36 48, 60, 72	E 1-1/4 (32)	B Back-to-Back S Single	45 45 Degree	630 Satin Stainless Steel 19 Matte black	

IN (MM), †) CENTER-TO-CENTER.

NOT ALL COMBINATIONS OF STANDARD LENGTHS, TYPES & FINISHES ARE STOCKED. PLEASE REFER TO PRICE LIST OR CONTACT CANAROPA SALES AND SERVICE FOR DETAILS.



Single pulls are thru-bolt mounted with round end-caps

ACCESSORIES

19R45-B2B2SING-KIT-630	Kit to Reconfigure 1x 19R45-B2B PAIR to 2x 19R45-SINGLE-630
19R45-B2B2SING-KIT-19	Kit to Reconfigure 1x 19R45-B2B PAIR to 2x 19R45-SINGLE-19
19R45-2SING2B2B-KIT-630	Kit to Reconfigure 2x 19R45-SINGLE to 1x 19R45-B2B PAIR-630
19R45-2SING2B2B-KIT-19	Kit to Reconfigure 2x 19R45-SINGLE to 1x 19R45-B2B PAIR-19

DIMENSIONS

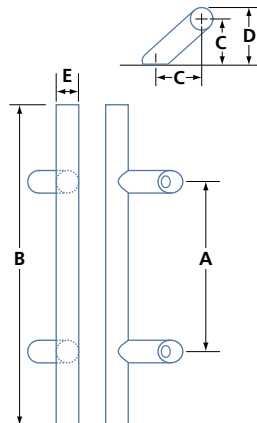

MODEL	A CENTER-TO-CENTER	B TOTAL LENGTH	C POSTS	D PROJECTION	E DIAMETER
19R12	12 (305)	24 (610)	2 25/32 (70.6)	3 13/32 (86.6)	1 1/4 (32)
19R24	24 (610)	36 (915)	2 25/32 (70.6)	3 13/32 (86.6)	1 1/4 (32)
19R36	36 (915)	48 (1220)	2 25/32 (70.6)	3 13/32 (86.6)	1 1/4 (32)
19R48	48 (1220)	60 (1524)	2 25/32 (70.6)	3 13/32 (86.6)	1 1/4 (32)
19R60	60 (1524)	72 (1829)	2 25/32 (70.6)	3 13/32 (86.6)	1 1/4 (32)
19R72	72 (1829)	84 (2134)	2 25/32 (70.6)	3 13/32 (86.6)	1 1/4 (32)

IN (MM)



DOOR PULLS

GENERAL HARDWARE

DOREX 19R-E 316 SERIES

LADDER PULLS, ROUND, 1 1/4" DIAMETER, 316 MARINE GRADE



APPLICATIONS

- For wood or metal doors 1 3/8–2 1/4" (35–57 mm) thick
- For glass doors 5/16– 1/2" (8–13 mm) thick
- Ideal for outdoor use

FEATURES

- Marine grade, 316 stainless steel
- Available in paired or single pulls
- Single pulls are thru-bolt mounted with round end-caps
- All necessary mounting hardware included
- Washers included
- Packaged in an eco-friendly, fully recyclable, box



SELECTION GUIDE

SERIES	LENGTH†	DIAMETER	TYPE	FINISH	DESCRIPTION
19R	24, 36, 48, 60	E 1-1/4 (32)	B Back-to-Back S Single	316 Satin Stainless Steel	Ladder Pull, 1 1/4" (32 mm) Round, 24" Center-to-Center, Back-to-Back, 316 Satin Stainless Steel

IN (MM), †) CENTER-TO-CENTER.

NOT ALL COMBINATIONS OF STANDARD LENGTHS, TYPES & FINISHES ARE STOCKED. PLEASE REFER TO PRICE LIST OR CONTACT CANAROPA SALES AND SERVICE FOR DETAILS.



Single pulls are thru-bolt mounted with round end-caps

DIMENSIONS

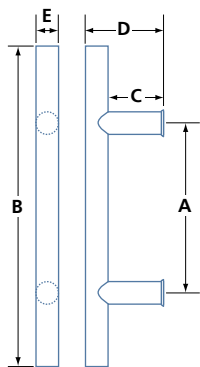

MODEL	A CENTER-TO-CENTER	B TOTAL LENGTH	C POSTS	D PROJECTION	E DIAMETER
19R12	12 (305)	24 (610)	2 7/16 (62)	3 11/16 (94)	1 1/4 (32)
19R24	24 (610)	36 (915)	2 7/16 (62)	3 11/16 (94)	1 1/4 (32)
19R36	36 (915)	48 (1220)	2 7/16 (62)	3 11/16 (94)	1 1/4 (32)
19R48	48 (1220)	60 (1524)	2 7/16 (62)	3 11/16 (94)	1 1/4 (32)
19R60	60 (1524)	72 (1829)	2 7/16 (62)	3 11/16 (94)	1 1/4 (32)

IN (MM)

DOOR PULLS

GENERAL HARDWARE

DOREX 19Q-E SERIES

LADDER PULLS, SQUARE, 1 1/4"

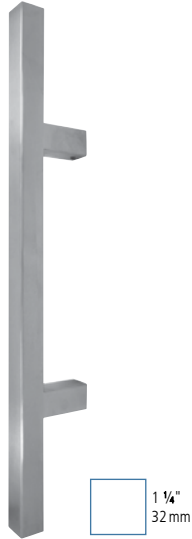

Single pulls are thru-bolt mounted with round end-caps

APPLICATIONS

- For wood or metal doors 1 3/8–2 1/4" (35–57 mm) thick
- For glass doors 5/16– 1/2" (8–13 mm) thick

FEATURES

- 304 Stainless steel
- Available in paired or single pulls
- Single pulls are thru-bolt mounted with round end-caps
- All necessary mounting hardware included
- Matching washers for different finishes included
- Packaged in an eco-friendly, fully recyclable, box



SELECTION GUIDE

SERIES	LENGTH†	DIAMETER	TYPE	FINISH	DESCRIPTION
19Q	24	E	B	630	Ladder Pull, 1 1/4" (32 mm) Square, 24" Center-to-Center, Back-to-Back, Satin Stainless Steel
	12, 24, 36 48, 60, 72	E 1-1/4 (32)	B Back-to-Back S Single	630 Satin Stainless Steel 19 Matte black	

IN (MM), †) CENTER-TO-CENTER.

NOT ALL COMBINATIONS OF STANDARD LENGTHS, TYPES & FINISHES ARE STOCKED. PLEASE REFER TO PRICE LIST OR CONTACT CANAROPA SALES AND SERVICE FOR DETAILS.

DIMENSIONS

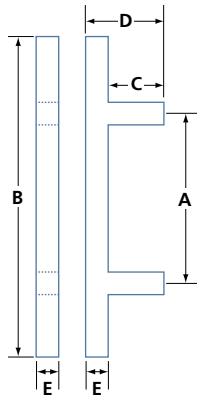

MODEL	A CENTER-TO-CENTER	B TOTAL LENGTH	C POSTS	D PROJECTION	E GRIP
19Q12	12 (305)	24 (610)	27/16 (62)	3 1/16 (94)	1 1/4 (32)
19Q24	24 (610)	36 (915)	27/16 (62)	3 1/16 (94)	1 1/4 (32)
19Q36	36 (915)	48 (1220)	27/16 (62)	3 1/16 (94)	1 1/4 (32)
19Q48	48 (1220)	60 (1524)	27/16 (62)	3 1/16 (94)	1 1/4 (32)
19Q60	60 (1524)	72 (1829)	27/16 (62)	3 1/16 (94)	1 1/4 (32)
19Q72	72 (1829)	84 (2134)	27/16 (62)	3 1/16 (94)	1 1/4 (32)

IN (MM)



DOOR PULLS

GENERAL HARDWARE

DOREX 18R-E SERIES

STRAIGHT ROUND PULLS, MITERED, 1¼" DIAMETER

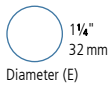

APPLICATIONS

- For wood or metal doors 1⅜ – 2¼" (35–57 mm) thick
- For glass doors ⅝ – ½" (8–13 mm) thick

FEATURES

- 304 Stainless steel
- Available in paired or single pulls
- Single pulls are thru-bolt mounted with round end-caps
- All necessary mounting hardware included
- Matching washers for different finishes included
- Packaged in an eco-friendly, fully recyclable, box



SELECTION GUIDE

SERIES	LENGTH†	DIAMETER	TYPE	FINISH	DESCRIPTION
18R	24	E	B	630	Straight Round Pull, 1¼" (32 mm) Mitered, 24" Center-to-Center, Back-to-Back, Satin Stainless Steel
	36		S	19	
	48, 60, 72	E 1-1/4 (32)	B Back-to-Back S Single	630 Satin Stainless Steel 19 Matte black	

IN (MM), † CENTER-TO-CENTER.

NOT ALL COMBINATIONS OF STANDARD LENGTHS, TYPES & FINISHES ARE STOCKED. PLEASE REFER TO PRICE LIST OR CONTACT CANAROPA SALES AND SERVICE FOR DETAILS.



Single pulls are thru-bolt mounted with round end-caps

DIMENSIONS

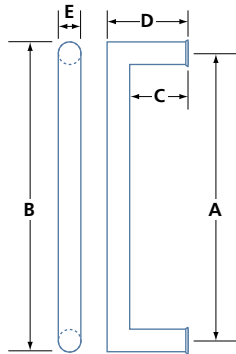

MODEL	A CENTER-TO-CENTER	B TOTAL LENGTH	C POSTS	D PROJECTION	E DIAMETER
18R24	24 (610)	25¼ (641)	27/16 (62)	31/16 (94)	1¼ (32)
18R36	36 (915)	37¼ (946)	27/16 (62)	31/16 (94)	1¼ (32)
18R48	48 (1220)	49¼ (1251)	27/16 (62)	31/16 (94)	1¼ (32)
18R60	60 (1524)	61¼ (1556)	27/16 (62)	31/16 (94)	1¼ (32)
18R72	72 (1829)	73¼ (1861)	27/16 (62)	31/16 (94)	1¼ (32)

IN (MM)

DOOR PULLS

GENERAL HARDWARE

DOREX 18Q-E SERIES

STRAIGHT SQUARE PULLS, MITERED, 1 1/4"



Single pulls are thru-bolt mounted with round end-caps

APPLICATIONS

- For wood or metal doors 1 3/8–2 1/4" (35–57 mm) thick
- For glass doors 5/16–1/2" (8–13 mm) thick

FEATURES

- 304 Stainless steel
- Available in paired or single pulls
- Single pulls are thru-bolt mounted with round end-caps
- All necessary mounting hardware included
- Matching washers for different finishes included
- Packaged in an eco-friendly, fully recyclable, box



SELECTION GUIDE

SERIES	LENGTH†	DIAMETER	TYPE	FINISH	DESCRIPTION
18Q	24	E	B	630	Straight Square Pull, 1 1/4" (32 mm) Mitered, 24" Center-to-Center, Back-to-Back, Satin Stainless Steel
	24, 36	E 1-1/4 (32)	B Back-to-Back	630 Satin Stainless Steel	
	48, 60, 72		S Single	19 Matte black	

IN (MM), †) CENTER-TO-CENTER.

NOT ALL COMBINATIONS OF STANDARD LENGTHS, TYPES & FINISHES ARE STOCKED. PLEASE REFER TO PRICE LIST OR CONTACT CANAROPA SALES AND SERVICE FOR DETAILS.

DIMENSIONS

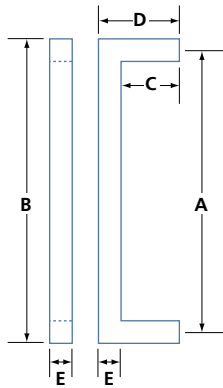

MODEL	A CENTER-TO-CENTER	B TOTAL LENGTH	C POSTS	D PROJECTION	E GRIP
18Q24	24 (610)	25 1/4 (641)	27/16 (62)	3 11/16 (94)	1 1/4 (32)
18Q36	36 (915)	37 1/4 (946)	27/16 (62)	3 11/16 (94)	1 1/4 (32)
18Q48	48 (1220)	49 1/4 (1251)	27/16 (62)	3 11/16 (94)	1 1/4 (32)
18Q60	60 (1524)	61 1/4 (1556)	27/16 (62)	3 11/16 (94)	1 1/4 (32)
18Q72	72 (1829)	73 1/4 (1861)	27/16 (62)	3 11/16 (94)	1 1/4 (32)

IN (MM)



DOOR PULLS

GENERAL HARDWARE

DOREX 18T-F SERIES

STRAIGHT RECTANGULAR PULLS, MITERED, 1½" x 1"

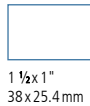

1 ½" x 1"
38 x 25.4 mm



Single pulls are thru-bolt mounted with round end-caps

APPLICATIONS

- For wood or metal doors 1¾–2¼" (35–57mm) thick
- For glass doors ⅝–½" (8–13 mm) thick

FEATURES

- 304 Stainless steel
- Available in paired or single pulls
- Single pulls are thru-bolt mounted with round end-caps
- All necessary mounting hardware included
- Matching washers for different finishes included
- Packaged in an eco-friendly, fully recyclable, box



SELECTION GUIDE

SERIES	LENGTH†	DIMENSION	TYPE	FINISH	DESCRIPTION
18T	24	F	B	630	Straight Rectangular Pull, 1½x1" (38x25.4 mm) Mitered, 24" Center-to-Center, Back-to-Back, Satin Stainless Steel
	24, 36 48, 60, 72	F 1-1/2x1 (38x25.4)	B Back-to-Back S Single	630 Satin Stainless Steel 19 Matte black	

IN (MM), †) CENTER-TO-CENTER.

NOT ALL COMBINATIONS OF STANDARD LENGTHS, TYPES & FINISHES ARE STOCKED. PLEASE REFER TO PRICE LIST OR CONTACT CANAROPA SALES AND SERVICE FOR DETAILS.

DIMENSIONS

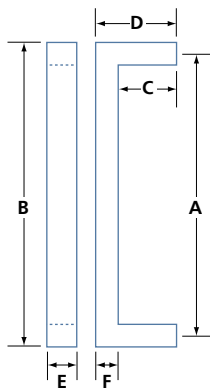

MODEL	A CENTER-TO-CENTER	B TOTAL LENGTH	C POSTS	D PROJECTION	E GRIP WIDTH	F GRIP HEIGHT
18T24	24 (610)	25 (635)	2⅝ (67)	3⅝ (92.4)	1½ (38)	1 (25.4)
18T36	36 (915)	37 (940)	2⅝ (67)	3⅝ (92.4)	1½ (38)	1 (25.4)
18T48	48 (1220)	49 (1245)	2⅝ (67)	3⅝ (92.4)	1½ (38)	1 (25.4)
18T60	60 (1524)	61 (1549)	2⅝ (67)	3⅝ (92.4)	1½ (38)	1 (25.4)
18T72	72 (1829)	73 (1854)	2⅝ (67)	3⅝ (92.4)	1½ (38)	1 (25.4)

IN (MM)

DOOR PULLS

GENERAL HARDWARE

DOREX 20R-E SERIES

OFFSET ROUND D-PULLS, MITERED, 1¼" DIAMETER



APPLICATIONS

- For wood or metal doors 1⅜–2¼" (35–57 mm) thick
- For glass doors ⅝–½" (8–13 mm) thick

FEATURES

- 304 Stainless steel
- Available in paired or single pulls
- Single pulls are thru-bolt mounted with round end-caps
- All necessary mounting hardware included
- Matching washers for different finishes included
- Packaged in an eco-friendly, fully recyclable, box

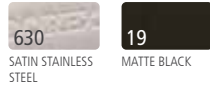

SELECTION GUIDE

SERIES	LENGTH†	DIAMETER	TYPE	FINISH	DESCRIPTION
20R	24	E	B	630	Offset Round D-Pull, 1¼ (32 mm) Mitered, 24" Center-to-Center, Back-to-Back, Satin Stainless Steel Finish
	10, 24, 36 48, 60	E 1-1/4 (32)	B Back-to-Back S Single	630 Satin Stainless Steel 19 Matte black	

IN (MM), (†) CENTER-TO-CENTER.

NOT ALL COMBINATIONS OF STANDARD LENGTHS, TYPES & FINISHES ARE STOCKED. PLEASE REFER TO PRICE LIST OR CONTACT CANAROPA SALES AND SERVICE FOR DETAILS.



Single pulls are thru-bolt mounted with round end-caps

DIMENSIONS

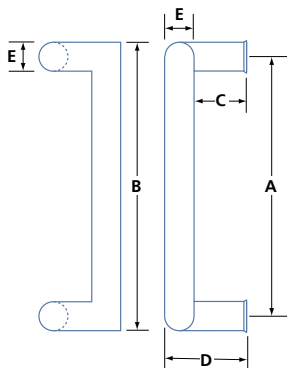

MODEL	A CENTER-TO-CENTER	B TOTAL LENGTH	C POSTS	D PROJECTION	E DIAMETER
20R10	10 (254)	11¼ (286)	2⅞ (62)	3⅞ (94)	1¼ (32)
20R24	24 (609.6)	25¼ (641)	2⅞ (62)	3⅞ (94)	1¼ (32)
20R36	36 (914.4)	37¼ (946)	2⅞ (62)	3⅞ (94)	1¼ (32)
20R48	48 (1219.2)	49¼ (1251)	2⅞ (62)	3⅞ (94)	1¼ (32)
20R60	60 (1524)	61¼ (1556)	2⅞ (62)	3⅞ (94)	1¼ (32)

IN (MM)



DOOR PULLS

GENERAL HARDWARE

DOREX 20T-E SERIES

OFFSET RECTANGULAR D-PULLS, MITERED, 1 1/4" x 3/4" DIAMETER



1 1/4 x 3/4"
32 x 19 mm

APPLICATIONS

- For wood or metal doors 1 3/8"–2 1/4" (35–57 mm) thick
- For glass doors 5/16"–1/2" (8–13 mm) thick

FEATURES

- 304 Stainless steel
- Available in paired or single pulls
- Single pulls are thru-bolt mounted with round end-caps
- All necessary mounting hardware included
- Matching washers for different finishes included
- Can be installed on 2" (51 mm) aluminum doors and frame with 1/2" (12.7 mm) door stop
- Packaged in an eco-friendly, fully recyclable, box



630
SATIN STAINLESS
STEEL



19
MATTE BLACK



Single pulls are thru-bolt mounted with round end-caps

SELECTION GUIDE

SERIES	LENGTH [†]	DIMENSION	TYPE	FINISH	DESCRIPTION
20T	24	E	B	630	Offset Rectangular D-Pull, 1 1/4 x 3/4" (32 x 19 mm) Mitered, 24" Center-to-Center, Back-to-Back, Satin Stainless Steel
	10, 24, 36 48, 60	E 1-1/4 x 3/4 (32 x 19)	B Back-to-Back S Single	630 Satin Stainless Steel 19 Matte black	

IN (MM), (†) CENTER-TO-CENTER.

NOT ALL COMBINATIONS OF STANDARD LENGTHS, TYPES & FINISHES ARE STOCKED. PLEASE REFER TO PRICE LIST OR CONTACT CANAROPA SALES AND SERVICE FOR DETAILS.

DIMENSIONS

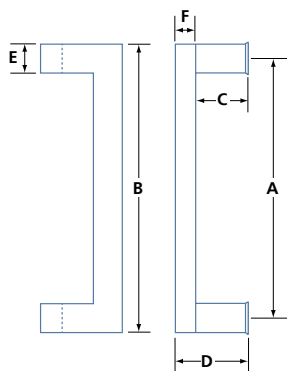

MODEL	A CENTER-TO-CENTER	B TOTAL LENGTH	C POSTS	D PROJECTION	E GRIP WIDTH	F GRIP HEIGHT
20T10	10 (254)	11 1/4 (286)	2 1/16 (68)	3 7/16 (87)	1 1/4 (32)	3/4 (19)
20T24	24 (609.6)	25 1/4 (641)	2 1/16 (68)	3 7/16 (87)	1 1/4 (32)	3/4 (19)
20T36	36 (914.4)	37 1/4 (946)	2 1/16 (68)	3 7/16 (87)	1 1/4 (32)	3/4 (19)
20T48	48 (1219.2)	49 1/4 (1251)	2 1/16 (68)	3 7/16 (87)	1 1/4 (32)	3/4 (19)
20T60	60 (1524)	61 1/4 (1556)	2 1/16 (68)	3 7/16 (87)	1 1/4 (32)	3/4 (19)

IN (MM)

DOOR PULLS

GENERAL HARDWARE

DOREX 18R-B SERIES

STRAIGHT ROUND PULLS, MITERED, $\frac{3}{4}$ " DIAMETER



APPLICATIONS

- For wood or metal doors & panels $1\frac{3}{8}$ – $2\frac{1}{4}$ " (35–57 mm) thick
- For glass doors $\frac{5}{16}$ – $\frac{1}{2}$ " (8–13 mm) thick
- Ideal for millwork/cabinet applications

FEATURES

- Stainless steel
- Available in paired or single pulls
- Single pulls are thru-bolt mounted with round end-caps
- All necessary mounting hardware included
- Washers included (clear plastic)



SELECTION GUIDE

SERIES	LENGTH†	DIAMETER	TYPE	FINISH	DESCRIPTION
18R	24	B	B	630	Straight Round Pull, $\frac{3}{4}$ " (19 mm) Mitered, 24" Center-to-Center, Back-to-Back, Satin Stainless Steel
	12, 16, 24	B $\frac{3}{4}$ (19)	B Back-to-Back S Single	630 Satin Stainless Steel 19 Matte black	

IN (MM), †) CENTER-TO-CENTER.

NOT ALL COMBINATIONS OF STANDARD LENGTHS, TYPES & FINISHES ARE STOCKED. PLEASE REFER TO PRICE LIST OR CONTACT CANAROPA SALES AND SERVICE FOR DETAILS.



Single pulls are thru-bolt mounted with round end-caps



18R-BWBB-KIT-630 BOWL WASHERS

- Replaces included washers for an optional aesthetic look
- 2 Washers per kit

DIMENSIONS

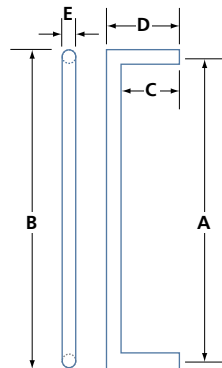

MODEL	A CENTER-TO-CENTER	B TOTAL LENGTH	C POSTS	D PROJECTION	E DIAMETER
18R12	$11\frac{13}{16}$ (300)	$12\frac{9}{16}$ (319)	$1\frac{3}{4}$ (44)	$2\frac{1}{2}$ (63.5)	$\frac{3}{4}$ (19)
18R16	$15\frac{3}{4}$ (400)	$16\frac{1}{2}$ (419)	$1\frac{3}{4}$ (44)	$2\frac{1}{2}$ (63.5)	$\frac{3}{4}$ (19)
18R24	$23\frac{5}{8}$ (600)	$24\frac{3}{8}$ (619)	$1\frac{3}{4}$ (44)	$2\frac{1}{2}$ (63.5)	$\frac{3}{4}$ (19)

IN (MM)



DOOR PULLS

GENERAL HARDWARE

DOREX 19R-B SERIES

LADDER ROUND PULLS, 3/4" DIAMETER



APPLICATIONS

- For wood or metal doors & panels 1 3/8–2 1/4" (35–57 mm) thick
- For glass doors 5/16– 1/2" (8–13 mm) thick
- Ideal for millwork/cabinet applications

FEATURES

- Stainless steel
- Available in paired or single pulls
- Single pulls are thru-bolt mounted with round end-caps
- All necessary mounting hardware included
- Washers included (clear plastic)



SELECTION GUIDE

SERIES	LENGTH†	DIAMETER	TYPE	FINISH	DESCRIPTION
19R	24	B	B	630	Ladder Pull, 3/4" (19mm) Round, 24" Center-to-Center, Back-to-Back, Satin Stainless Steel
	12, 16, 24	B 3/4 (19)	B Back-to-Back S Single	630 Satin Stainless Steel 19 Matte black	

IN (MM), †) CENTER-TO-CENTER.

NOT ALL COMBINATIONS OF STANDARD LENGTHS, TYPES & FINISHES ARE STOCKED. PLEASE REFER TO PRICE LIST OR CONTACT CANAROPA SALES AND SERVICE FOR DETAILS.



Single pulls are thru-bolt mounted with round end-caps



18R-BWBB-KIT-630 BOWL WASHERS

- Replaces included washers for an optional aesthetic look
- 2 Washers per kit

DIMENSIONS

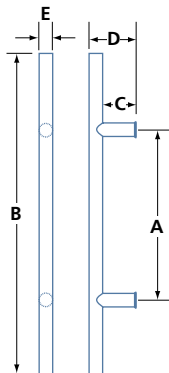

MODEL	A CENTER-TO-CENTER	B TOTAL LENGTH	C POSTS	D PROJECTION	E DIAMETER
19R12	11 13/16 (300)	17 3/4 (450)	1 3/4 (44)	2 1/2 (63.5)	3/4 (19)
19R16	15 3/4 (400)	21 5/8 (550)	1 3/4 (44)	2 1/2 (63.5)	3/4 (19)
19R24	21 5/8 (550)	27 9/16 (700)	1 3/4 (44)	2 1/2 (63.5)	3/4 (19)

IN (MM)

FLUSH PULLS

GENERAL HARDWARE

ARCHITECTURAL FLUSH PULLS

FP



FP414-60



FP410-135



FP412-135



FPC402-135



FP416-300



FPC406-300

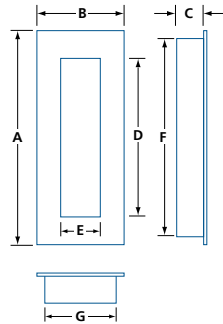

- For wood doors or panels
- Press fit mounting
- Stainless steel
- Available with or without spring cover

Dimensions for reference only.

Please request samples prior to door preparation.

MODEL	FINISH	A	B	C	D	E	F	G
FP410-135	-629,	5 ⁵ / ₁₆	2 ³ / ₄	1 ¹ / ₁₆	3 ¹⁵ / ₁₆	1	4 ¹⁵ / ₁₆	1 ¹³ / ₁₆
	-630	(135)	(70)	(17)	(100)	(25)	(125)	(46)
FP412-135	-629,	5 ⁵ / ₁₆	2 ³ / ₁₆	1 ¹ / ₁₆	3 ¹⁵ / ₁₆	1	4 ¹⁵ / ₁₆	1 ¹³ / ₁₆
	-630	(135)	(55)	(17)	(100)	(25)	(125)	(46)
FP414-60	-629,	2 ³ / ₈	2 ³ / ₈	1 ¹ / ₁₆	1 ³ / ₁₆	1 ³ / ₁₆	2	2
	-630	(60)	(60)	(17)	(30)	(30)	(50)	(50)
FP416-300	-629,	11 ¹³ / ₁₆	2 ³ / ₁₆	1 ¹ / ₁₆	1	1	10 ⁷ / ₈	1 ¹³ / ₁₆
	-630	(300)	(55)	(17)	(25)	(25)	(276)	(46)
WITH SPRING COVER								
FPC402-135*	-629,	5 ⁵ / ₁₆	2 ³ / ₁₆	1 ¹ / ₁₆	3 ¹⁵ / ₁₆	1	4 ¹⁵ / ₁₆	1 ¹³ / ₁₆
	-630	(135)	(55)	(17)	(100)	(25)	(125)	(46)
FPC406-300*	-629,	11 ¹³ / ₁₆	2 ³ / ₁₆	1 ¹ / ₁₆	9 ¹³ / ₁₆	1	10 ¹⁵ / ₁₆	1 ¹³ / ₁₆
	-630	(300)	(55)	(17)	(250)	(25)	(278)	(46)

IN (MM) (*) SPECIAL ORDER



FP224-70



FP224-110

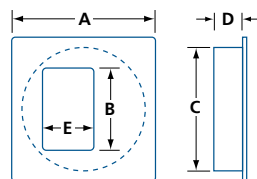

- For wood doors or panels
- Stainless steel
- Back-to-back mounting possible

Dimensions for reference only.

Please request samples prior to door preparation.

MODEL	FINISH	A	B	∅ C	D	E	F	G
FP224-70	-630	∅ 2 ³ / ₄ (70)	1 ¹ / ₂ (40)	2 ³ / ₈ (60)	5/8 (15)	1 (25)	—	—
FP224-110	-630	∅ 4 ⁵ / ₁₆ (110)	2 ¹¹ / ₁₆ (68)	4 (102)	5/8 (15)	1 ⁵ / ₁₆ (34)	—	—

IN (MM)

FLUSH PULLS

GENERAL HARDWARE

ARCHITECTURAL FLUSH PULLS

FP



FP231-180

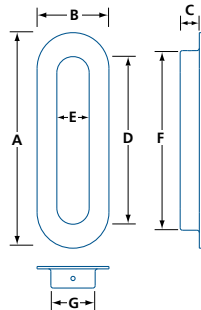

- For wood doors or panels
- Stainless steel
- Mounting screws included
- Back-to-back mounting possible

*Dimensions for reference only.
Please request samples prior to door preparation.*

MODEL	FINISH	A	B	C	D	E	F	G
FP231-180	-630	7 ³ / ₃₂ (180)	2 ³ / ₈ (60)	⁹ / ₁₆ (14)	5 ¹ / ₂ (140)	1 ¹ / ₁₆ (26)	5 ¹³ / ₁₆ (148)	1 ⁷ / ₁₆ (37)

IN (MM)



FP225-50

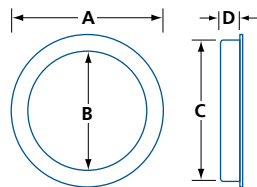

- For wood doors or panels
- Stainless steel
- Sizes 50 and 70 include mounting screws
- Back-to-back mounting possible

*Dimensions for reference only.
Please request samples prior to door preparation.*



FP225-70

MODEL	FINISH	∅ A	∅ B	∅ C	D	E	F	G
FP225-50	-630	2 (50)	1 ¹ / ₄ (31)	1 ⁹ / ₁₆ (40)	⁷ / ₁₆ (10.7)	—	—	—
FP225-70	-630, -19	2 ³ / ₄ (70)	2 (50)	2 ³ / ₈ (60)	¹ / ₂ (13.2)	—	—	—
FP225-110	-630	4 ⁵ / ₁₆ (110)	3 ³ / ₈ (86)	4 (102)	⁹ / ₁₆ (14)	—	—	—

IN (MM)



FP225-110



FLUSH PULLS

GENERAL HARDWARE

ARCHITECTURAL FLUSH PULLS

FP

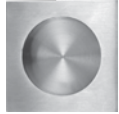

FP223R-64

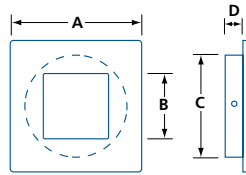

- For wood doors or panels
- Stainless steel
- Mounting screws included
- Back-to-back mounting possible

*Dimensions for reference only.
Please request samples prior to door preparation.*



FP223-70

MODEL	FINISH	A	B	∅ C	D	E	F	G
FP223R-64	-630, -19	2 1/2 (64)	1 3/4 (45)	2 1/8 (54)	1/2 (12.7)	—	—	—
FP223-50	-630, -19	2 (50)	1 (26)	1 9/16 (40)	7/16 (11.5)	—	—	—
FP223-70	-630, -19	2 3/4 (70)	1 9/16 (40)	2 3/8 (60)	1/2 (13.2)	—	—	—

IN (MM)



FP227-120



FP228-120

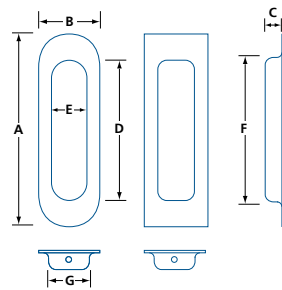

- For wood doors or panels
- Stainless steel
- Mounting screws included
- Back-to-back mounting possible

*Dimensions for reference only.
Please request samples prior to door preparation.*

MODEL	FINISH	A	B	C	D	E	F	G
FP227-120	-630, -19	4 11/16 (120)	1 5/8 (40)	7/16 (11)	3 5/16 (85)	7/8 (22)	3 5/8 (92)	1 1/16 (27)
FP228-120	-630, -19	4 11/16 (120)	1 5/8 (40)	7/16 (11)	3 5/16 (85)	7/8 (22)	3 5/8 (92)	1 1/16 (27)

IN (MM)



FP412-135B

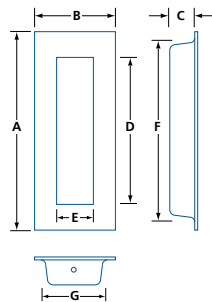

- For wood doors or panels
- Stainless steel
- Mounting screws included
- Back-to-back mounting possible

*Dimensions for reference only.
Please request samples prior to door preparation.*

MODEL	FINISH	A	B	C	D	E	F	G
FP412-135B	-630, -19	5 5/16 (135)	2 3/16 (55)	7/16 (11.5)	3 15/16 (100)	1 (25)	4 1/2 (114.5)	1 1/4 (32)

IN (MM)

FLUSH PULLS

GENERAL HARDWARE

MISCELLANEOUS FLUSH PULLS



2530C26

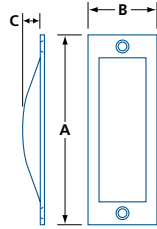

- For wood doors or panels
- Steel
- Wood screws included

MODEL	FINISH	A	B	C	CUT-OUT DIMENSION	/BOX
2530	BP, C15, C15A, C19, C26, CHR, C26D	4½ (114)	1⅝ (40)	½ (12.7)	1⅝ x 3½ x ½ (33.3 x 89 x 12.7)	50

IN (MM)



3503-26D

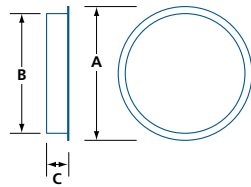

- For wood doors or panels
- Steel
- Fasteners NOT included

MODEL	FINISH	øA	øB	C	CUT-OUT DIMENSION	/BOX
3503	15, 19, 26, 26D	2⅞ (62)	2⅞ (53.5)	⅜ (9.5)	2⅞ DIA x ½ (54 DIA x 12.7)	150

IN (MM)



4100SS

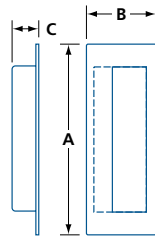

- For wood doors or panels
- Stainless steel
- Fasteners NOT included

MODEL	FINISH	A	B	C	CUT-OUT DIMENSION	/BOX
4100SS	Stainless steel	4½ (114)	1⅝ (40)	½ (12.7)	1⅝ x 3¾ x ⅝ (33.3 x 95 x 15.9)	25

IN (MM)



EDGE PULLS

GENERAL HARDWARE

EDGE PULLS

EP310, EP312, 3512

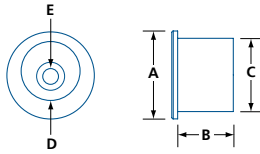

- For wood panels
- Stainless steel
- Wood screws included

MODEL	FINISH	MATERIAL	ø A	B	ø C	ø D	ø E
EP310-30	-630	Stainless Steel	1 ³ / ₁₆ (30)	¾ (19.5)	1 (25)	1 ³ / ₁₆ (20.5)	¾ (4.5)

IN (MM)

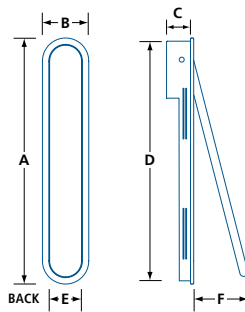

- For wood doors or panels
- Stainless steel

MODEL	FINISH	MATERIAL	A	B	C	D	E	F
EP312-154	-630	Stainless Steel	6 ³ / ₁₆ (158)	1 ³ / ₁₆ (30)	5/ ₈ (16)	5 ¹³ / ₁₆ (151)	1 (25)	3 ⁵ / ₁₆ (84)

IN (MM)

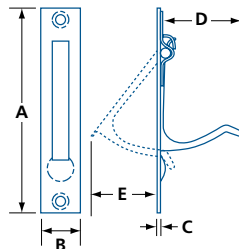

- For wood doors or panels
- Brass
- Wood screws included

MODEL	FINISH	MATERIAL	A	B	C	D	E	/BOX
3512	-32D	Brass	3 ⁷ / ₈ (98)	¾ (19.1)	5/ ₆₄ (2)	1 ⁹ / ₁₆ (39.6)	1 ¹ / ₄ (31.8)	25

IN (MM)

OTHER PULLS

GENERAL HARDWARE

BI-FOLD DOOR PULLS

3520, 3521

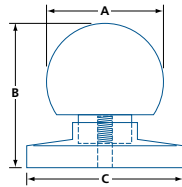

- For 1 $\frac{3}{8}$ " (35 mm) thick doors

MODEL	FINISH	MATERIAL	øA	B	øC	/BOX
3520	C3, C5, C15, C15A, C19, C26, C26D	Zinc die-cast	1 $\frac{1}{4}$ (31.8)	1 $\frac{5}{8}$ (41.3)	1 $\frac{3}{4}$ (44.5)	50

IN (MM)

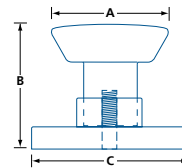

- For 1 $\frac{3}{8}$ " (35mm) thick doors

MODEL	FINISH	MATERIAL	øA	B	øC	D
3521	C15, C19, C26, C26D	Zinc die-cast	1 $\frac{1}{4}$ (31.8)	1 $\frac{1}{16}$ (17)	1 (25)	$\frac{3}{4}$ (20.5)

IN (MM)

MULTI-PURPOSE STEEL PULL

H2381CHR

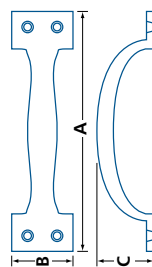

- Available in 3" (76 mm) and 8" (203 mm) lengths
- Fasteners not included

MODEL	FINISH	MATERIAL	A	B	C	/BOX
H2381CHR3	Chrome Plated	Steel	3 (76)	$\frac{3}{4}$ (19)	$\frac{3}{4}$ (19.1)	12
H2381CHR8	Chrome Plated	Steel	8 (203)	2 $\frac{1}{4}$ (57)	2 (50.8)	10

IN (MM)

OTHER PULLS

GENERAL HARDWARE

6½" MULTI-PURPOSE STEEL PULL

328ZP

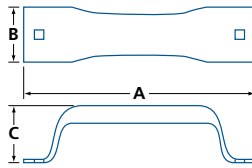

• Fasteners not included

MODEL	FINISH	MATERIAL	A	B	C	/BOX
328ZP	Zinc Plated	Steel	6¼ (159)	1½ (38.1)	1⅝ (41.3)	20

IN (MM)

SURFACE MOUNTED CHEST HANDLE

2535ZP

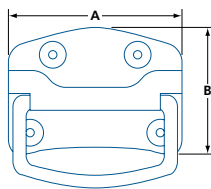

• Fasteners not included

MODEL	FINISH	MATERIAL	A	B	/BOX
2535ZP	Zinc Plated	Steel	4⅞ (105)	3⅞ (79)	20

IN (MM)



DOOR PULLS & PLATES

GENERAL HARDWARE

ALUMINUM DOOR PULL AND PLATE

H1410, H1411



H1410
H1411

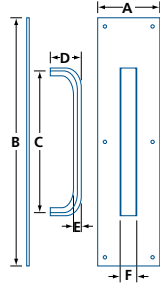

- Aluminum door pull and plate
- D-Type pull
- Handle available separately (with fasteners)
- Supplied with six # 6 x 3/4" (19.1 mm) long wood screws, two 1/4-20 UNC x 2 3/8" (60 mm) long machine screws and cup-washers

MODEL	FINISH	A	B	C	D	E	F	/CASE
H1410	Aluminum	4 (102)	16 (406)	9 (229)	2 (50.8)	15/32 (12)	1 1/16 (26.9)	32
H1411	Aluminum	3 1/2 (89)	15 (381)	7 (178)	2 (50.8)	15/32 (12)	1 1/16 (26.9)	40

IN (MM)

STAINLESS STEEL DOOR PULL AND PLATE

14R09P



14R09P-32D

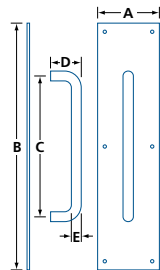

- Stainless steel door pull and plate
- Round pull
- Handle available separately (with fasteners)
- Supplied with six # 6 x 3/4" (19.1 mm) long wood screws, two 1/4-20 UNC x 2 3/8" (60 mm) long machine screws and cup-washers

MODEL	FINISH	A	B	C	D	E	/CASE
14R09P	32D	4 (102)	16 (406)	9 (229)	2 1/4 (57)	3/4 (19)	20

IN (MM)

DOOR PULLS & PLATES

GENERAL HARDWARE

ALUMINUM DOOR PULL

H1412, H1413



H1412
H1413

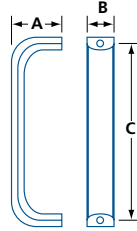

- Aluminum door pull
- D-Type pull
- Pull supplied with two 1/4-20 UNC x 2 3/8" (60mm) long machine screws and cup-washers

MODEL	FINISH	A	B	C	/CASE
H1412	Aluminum	2 (50.8)	1 (25)	7 (178)	20
H1413	Aluminum	2 (50.8)	1 (25)	9 (229)	20

IN (MM)

STAINLESS STEEL DOOR PULL

14R09P



14R09-32D

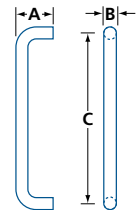

- Stainless steel door pull
- Round pull
- Pull supplied with two 1/4-20 UNC x 2 3/8" (60mm) long machine screws and cup-washers

MODEL	FINISH	A	B	C	/CASE
14R09	32D	2 1/4 (57)	3/4 (19.1)	9 (229)	20

IN (MM)

PULL BACK PLATE

130315, 130416

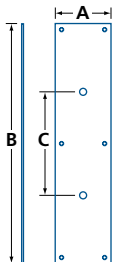

- Back plate for commercial pulls
- Mounting hardware included: wood screws

MODEL	FINISH	MATERIAL	A	B	C
130315	AL	Aluminum	3 1/2 (89)	15 (381)	7 (177.8)
130416	BP032	Brass	4 (102)	16 (406)	9 (228.6)

IN (MM)



PUSH & KICK PLATES

GENERAL HARDWARE

PUSH PLATES

1403, 1404, 1405



140315 AL

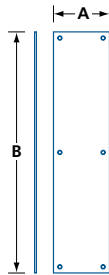

- Prevents damage caused by hands
- Recommended for high-traffic areas such as restaurants, restrooms, and other commercial and industrial areas
- Mounting hardware included: wood screws

MODEL	FINISH	MATERIAL	A	B
140315	AL	Aluminum	3½ (89)	15 (381)
	BP032	Brass		
140416	-32D	Stainless steel	4 (102)	16 (406)
140520	AL	Aluminum	5 (127)	20 (508)
	-32D	Stainless steel		

IN (MM)

KICK PLATES

1508, 1510, 1512



151234-32D

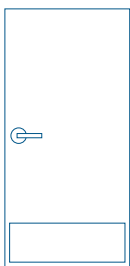
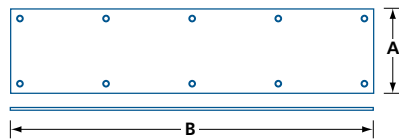

H = 8 to 12"
(203–305 mm)
W = [total width of the door]
– 1½" (38 mm)

- Prevents damage caused by feet
- Recommended for high-traffic areas such as restaurants, restrooms, and other commercial and industrial areas
- Mounting hardware included: wood screws

MODEL	FINISH	MATERIAL	A	B
150828			8 (203)	28½ (724)
150830			8 (203)	30½ (775)
150832	AL	Aluminum	8 (203)	32½ (826)
	BP032	Brass		
150834	-32D	Stainless steel	8 (203)	34½ (876)
150842			8 (203)	42½ (1080)
151028			10 (254)	28½ (724)
151030	AL	Aluminum	10 (254)	30½ (775)
151032	BP032	Brass	10 (254)	32½ (826)
	-32D	Stainless steel		
151034			10 (254)	34½ (876)
151234	AL	Aluminum	12 (305)	34½ (876)
	BP032	Brass		
	-32D	Stainless steel		

IN (MM)

KICK, PUSH & BACK PLATES

GENERAL HARDWARE

KICK PLATES

PKS, PKT



PKS0120-1034-32D

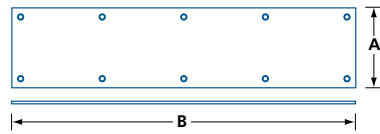

- Prevents damage caused by feet, mops, carts, or hand trucks
- Made with 201 Stainless Steel
- Two mounting methods available:
 - » PKS models include pre-drilled counter sunk holes and wood screws
 - » PKT models have no holes and include adhesive strips

MODEL	FINISH	MATERIAL	A	B
PKS0120-0834	32D	201 Stainless steel	8 (203)	34½ (876)
PKS0120-1034			10 (254)	34½ (876)
PKT0120-0834	32D	201 Stainless steel	8 (203)	34½ (876)
PKT0120-1034			10 (254)	34½ (876)

IN (MM)

PUSH PLATES

PPS, PPT

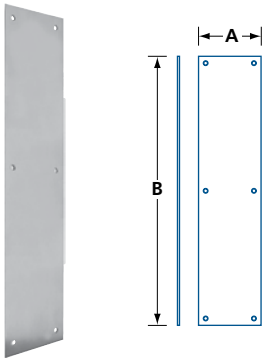

PPS0120-0416-32D

- Prevents damage caused by hands
- Recommended for high-traffic areas such as restaurants, restrooms, and other commercial and industrial areas
- Made with 201 Stainless Steel
- Two mounting methods available:
 - » PPS models include pre-drilled counter sunk holes and wood screws
 - » PPT models have no holes and include adhesive strips

MODEL	FINISH	MATERIAL	A	B
PPS0120-0416	32D	201 Stainless steel	4 (102)	16 (406)
PPT0120-0416			4 (102)	16 (406)

IN (MM)

PULL BACK PLATE

PBS

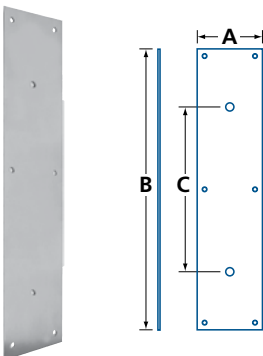

- Prevents damage caused by hands
- Recommended for high-traffic areas such as restaurants, restrooms, and other commercial and industrial areas
- Made with 201 Stainless Steel
- Pre-drilled holes for 9" (229mm) handle (sold separately)
- Includes pre-drilled counter sunk holes and wood screws for easy mounting

MODEL	FINISH	MATERIAL	A	B	C
PBS0120-0416	32D	201 Stainless steel	4 (102)	16 (406)	9 (229)

IN (MM)



FLOOR STOPS

GENERAL HARDWARE

DOMESTOP-LOW

T201



T200 C26D

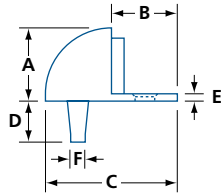

- For use with low or no threshold
- Heavy-duty zinc die-cast
- Non-marking rubber stop
- Mounting hardware included: wood screw and plastic anchor

- #T201 Riser allows easy conversion to threshold or carpet use

T201 C26D RISER



MODEL	FINISH	A	B	øC	D	E	øF	/BOX	/CASE
T200	C26D, C3, C4	1 (25.4)	7/8 (22.2)	1 3/4 (44.5)	3/4 (19.1)	3/32 (2.4)	3/16 (4.8)	10	200
T201	C26D	—	—	1 3/4 (44.5)	—	1/4 (6.4)	—	50	500

IN (MM)

DOMESTOP-HIGH

T218



T218 C26D

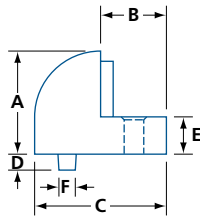

- For use with a threshold or undercut doors
- Heavy-duty zinc die-cast
- Non-marking rubber stop
- Includes wood screw and plastic anchor

MODEL	FINISH	A	B	øC	D	E	øF	/BOX	/CASE
T218	C26D, C3, C4	1 7/16 (36.5)	7/8 (22.2)	1 3/4 (44.5)	3/4 (19.1)	1/2 (12.7)	3/16 (4.8)	10	200

IN (MM)

DOMESTOP-UNIVERSAL

C229



C229 C26D

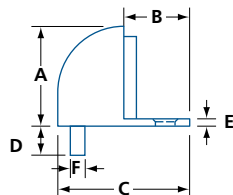

- For use with or without threshold
- Heavy-duty zinc die-cast
- Non-marking rubber stop
- Mounting hardware included: wood screw and plastic anchor

MODEL	FINISH	A	B	øC	D	E	øF	/BOX	/CASE
C229	C19, C26D	1 7/16 (36.5)	1 3/16 (20.6)	1 3/4 (44.5)	7/16 (11)	1/8 (3.2)	7/32 (5.6)	10	200

IN (MM)

FLOOR STOPS

GENERAL HARDWARE

SPRING STOP – UNIVERSAL

C230



C230-26D

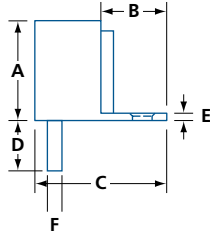

- For interior use with or without threshold
- Zinc die-cast body
- Spring loaded non-marking rubber stop
- Mounting hardware included: wood screw and anchor

MODEL	FINISH	A	B	øC	D	E	øF	/BOX
C230	19, 26D	1½ (38)	15/16 (24)	17/8 (47.4)	13/16 (21)	7/32 (6)	7/32 (5.6)	100

IN (MM)

FLOOR-MOUNTED DOOR STOP

R470, R471



R470C26D

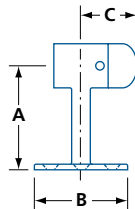

- For exterior / interior use
- Solid brass
- Non-marking rubber tip
- Mounting hardware included:
 - #R470 - wood screws
 - #R471 - lead shielding, masonry anchor, wood screws
- #R470REP - Replacement rubber tip

MODEL	FINISH	A	øB	C	/BOX
R470	C10B, C26D, C3	2½ (64)	23/16 (56)	15/16 (33.3)	12
R471	C26D, C3	2½ (64)	23/16 (56)	15/16 (33.3)	12

IN (MM)



FLOOR STOPS

GENERAL HARDWARE

COLUMN DOOR STOP

3530



3530-26D

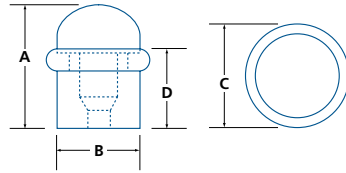

- For interior use
- Omni-directional stop
- Solid brass
- Mounting hardware included: wood screw with plastic anchor

MODEL	FINISH	A	øB	øC	D	/BOX
3530	26D, 19	1 ³ / ₄ (44.5)	1 ³ / ₁₆ (30.2)	1 ⁷ / ₁₆ (36.5)	1 ¹ / ₁₆ (28)	10

IN (MM)

COLUMN DOOR STOP

3531



3531-26D

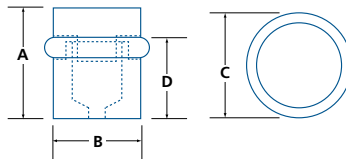

- For interior use
- Omni-directional stop
- Solid brass
- Mounting hardware included: wood and machine screws with masonry and plastic anchors

MODEL	FINISH	A	øB	øC	D	/BOX
3531	26D	1 ¹⁷ / ₃₂ (39)	1 ³ / ₁₆ (30.2)	1 ³ / ₈ (35)	1 ¹ / ₆₄ (29)	10

IN (MM)

COLUMN DOOR STOP

3532



3532-32D

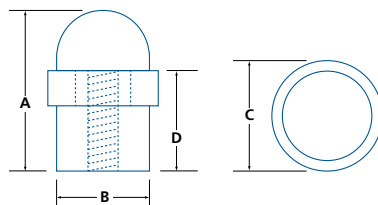

- For interior or exterior use
- Omni-directional stop
- Stainless steel
- Mounting hardware included: threaded bolt with masonry anchor

MODEL	FINISH	A	øB	øC	D	/BOX
3532	32D	2 (50.8)	1 ³ / ₁₆ (30.2)	1 ³ / ₈ (35)	1 ³ / ₈ (35)	10

IN (MM)

FLOOR STOPS

GENERAL HARDWARE

SQUARE DOOR STOP

3536



3536-630

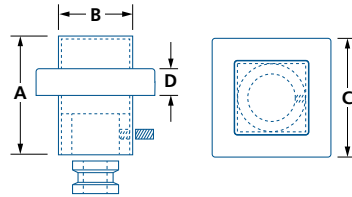

- For interior use
- Stainless steel, satin finish
- Mounting hardware included: wood screw and anchor

MODEL	FINISH	A	B	C	D	/UNIT
3536	630	1 ⁹ / ₁₆ (40)	1 (25)	1 ⁹ / ₁₆ (40)	⁹ / ₁₆ (14)	1

IN (MM)



WALL STOPS

GENERAL HARDWARE

FLEXIBLE WALL-MOUNTED DOOR STOPS

615, 3515, 3555



615C15



3515C15



3515C19



3555C15

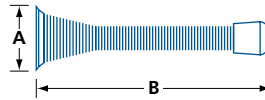

- For interior use
- Flexible steel spring
- Mounting hardware included: wood screw

MODEL	FINISH	ø A	B	/BOX	/CASE
615	C11P, C15, C15A, C3	15/16 (23.8)	3 (76)	50	600
3515	C11P, C15, C15A, C26, C26D, C3, C5	15/16 (23.8)	3 (76)	50	500
3515	C19	15/16 (23.8)	3 3/8 (86)	—	300
3555	C15	1 1/16 (26.9)	4 (102)	50	500

IN (MM)

RIGID WALL-MOUNTED DOOR STOP

692



692 BP



6131 C15

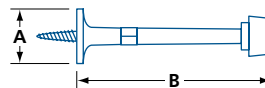

- For interior use
- Solid brass or zinc die-cast
- Integrated wood screw

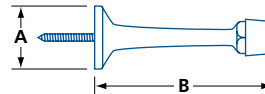

MODEL	FINISH	MATERIAL	ø A	B	/BOX	/CASE
692	BP	Zinc die-cast	1 3/16 (20.6)	2 7/8 (73)	50	—
6131	C10B, C15, C15A, C19, C26, C26D, C3	Solid brass	1 (25.4)	3 (76)	25	250

IN (MM)

RIGID WALL-MOUNTED DOOR STOP - SQUARE

3538



3538-630

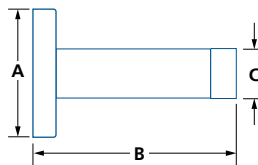

- For interior use
- Stainless steel, satin finish
- Concealed mounting screws
- Mounting hardware included: wood screw and plastic anchors

MODEL	FINISH	ø A	B	C	/UNIT
3538	630	1 27/32 (46.5)	3 5/32 (80)	3/4 (19)	1

IN (MM)

WALL STOPS

GENERAL HARDWARE

WALL-MOUNTED DOOR STOP

R474, R475

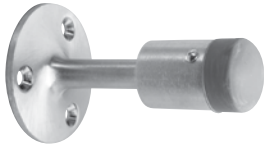

R474 C26D

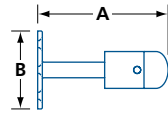

- For exterior / interior use
- Solid brass
- Non-marking rubber tip
- Mounting hardware included:
 - #R474 - wood screws
 - #R475 - lead shielding, masonry anchor, wood screws

#R470REP - Replacement rubber tip

MODEL	FINISH	A	ø B	/BOX
R474	C3, C26D	3½ (89)	2¾ (56)	12
R475	C26D	3½ (89)	2¾ (56)	12

IN (MM)

CONVEX & CONCAVE WALL-MOUNTED DOOR STOP

T231, T233



T231 C26D



T233 C26D

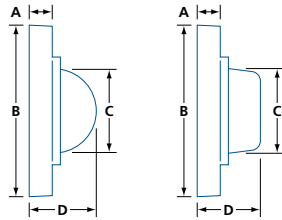

- Zinc die-cast
- Non-marking rubber
- Concealed mounting screws
- Mounting hardware included: wood screw, drywall anchors

MODEL	FINISH	A	ø B	ø C	D	/BOX	/CASE
T231	C19, C3, C26D	5/16 (7.9)	2½ (64)	1 1/16 (33.3)	1 (25.4)	25	250
T233	C19, C3, C26D	5/16 (7.9)	2½ (64)	1 1/16 (33.3)	1 (25.4)	25	250

IN (MM)

DOOR BUMPER

64BU

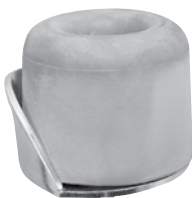

64BU

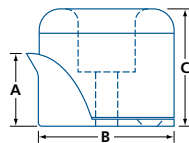

- Floor or wall mountable
- Non-marking rubber with steel support
- Mounting hardware included: wood screw

MODEL	FINISH	A	ø B	C	/BOX
64BU	Zinc plated	1 5/16 (23.8)	1 5/8 (41.3)	1 1/16 (33.3)	20

IN (MM)



ROLLER BUMPERS

GENERAL HARDWARE

ROLLER BUMPER STOP – OFFSET

RB300



RB300-26D

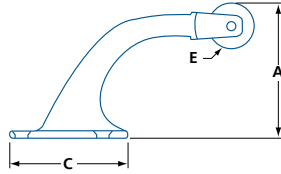

- Used to prevent damage when two doors open against each other
- Solid brass
- Arm offset (including roller): 2 3/4" (70 mm)
- Arm length (including base and roller): 5" (127 mm)
- Non-marking rubber roller
- Mounting hardware included: wood screws, plastic anchors

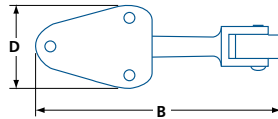
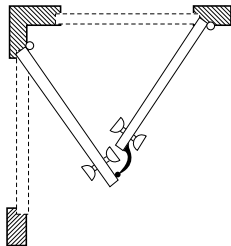

MODEL	FINISH	MATERIAL	A	B	C	D	øE	/BOX	/CASE
RB300	26D	Brass	2 3/4 (70)	5 (127)	2 1/4 (57)	1 3/4 (44)	15/16 (24)	10	100

IN (MM)

ROLLER BUMPER STOP - 4 1/2", 6"

RB400, RB600



RB400-26D

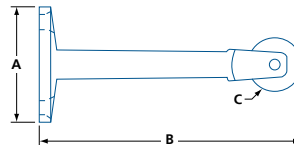

- Used to prevent damage when two doors meet each other at ~90deg (ie: back-to-back)
- Solid brass
- RB400 arm length (including roller): 4 1/2" (114 mm)
- RB600 arm length (including roller): 6" (152 mm)
- Non-marking rubber roller
- Mounting hardware included: wood screws, plastic anchors



RB600-26D

MODEL	FINISH	MATERIAL	A	B	ø C	/BOX	/CASE
RB400	26D	Brass	2 (50)	4 1/2 (114)	15/16 (24)	10	100
RB600	26D	Brass	2 (50)	6 (152)	15/16 (24)	8	80

IN (MM)

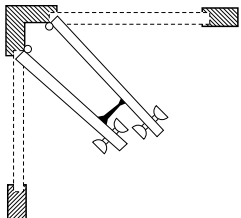

HINGE PIN STOPS

GENERAL HARDWARE

HINGE PIN STOPS

805, 3506



805

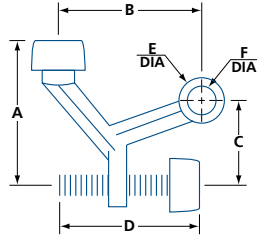

805

- For use on hinged doors
- Adjustable door opening angle
- Fits 1/4" (6 mm) diameter hinge pin

3506

- For use on hinged doors
- Adjustable door opening angle
- Removable nylon bushing
- Fits 1/4" (6 mm) or 5/16" (7.5 mm) diameter hinge pins

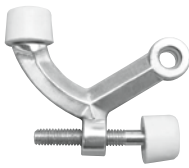

3506C15

MODEL	FINISH	A	B	C	D	øE	øF	/BOX
805	Brass plated	1 5/8 (41.3)	1 5/8 (41.3)	1 1/8 (28.6)	1 5/8 (41.5)	1/2 (13)	1/4 (6.4)	25
3506	C3, C11P, C15, C15A, C26D	1 5/8 (41.3)	2 (50.8)	1 1/8 (28.6)	1 15/16 (49.2)	9/16 (14.7)	1/4 OR 5/16* (6.4 OR 7.5)	25

IN (MM) (*) REMOVE BUSHING FOR LARGER DIAMETER

HINGE PIN STOP – PIVOTING SHOE

3507

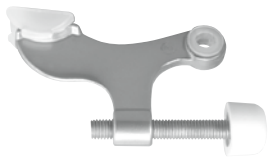

3507C15

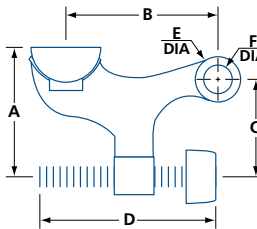

- For use on hinged doors
- Adjustable door opening angle
- Removable nylon brushing
- Fits 1/4" (6 mm) or 5/16" (7.5 mm) diameter hinge pins
- Zinc die-cast body
- Self-pivoting shoe

MODEL	FINISH	A	B	C	D	øE	øF	/BOX
3507	C3, C11P, C15, C15A, C26D	1 7/16 (36.5)	1 7/8 (47.6)	1 1/8 (28.6)	2 (50.8)	1/2 (13)	1/4 OR 5/16* (6.4 OR 7.5)	50

IN (MM) (*) REMOVE BUSHING FOR LARGER DIAMETER

HINGE PIN STOP

3508

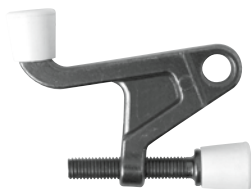

3508C15A

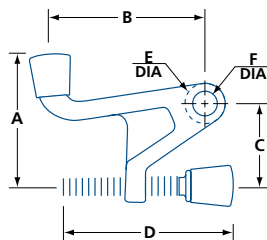

- For use on hinged doors
- Adjustable door opening angle
- Zinc die-cast body
- Removable nylon brushing
- Fits 1/4" (6 mm) or 5/16" (7.5 mm) diameter hinge pins

MODEL	FINISH	A	B	C	D	øE	øF	/BOX
3508	C15A, C26D	1 7/16 (36.5)	1 7/8 (47.6)	1 1/4 (31.8)	1 15/16 (49.2)	1/2 (13)	1/4 OR 5/16* (6.4 OR 7.5)	50

IN (MM) (*) REMOVE BUSHING FOR LARGER DIAMETER

HINGE PIN STOPS

GENERAL HARDWARE

HINGE PIN STOP – HEAVY DUTY

3509



3509

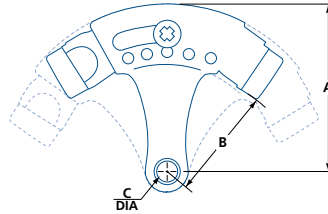

- For use on hinged doors
- Positive slip-proof adjustment
- 95 - 130° door opening adjustment
- Fits both $\frac{1}{4}$ " (6 mm) and $\frac{3}{16}$ " (8 mm) diameter hinge pins
- All steel construction
- Non-marring rubber tips

MODEL	FINISH	A	B	ϕ C	/BOX
3509	C11P, C15, C15A, C19, C26D	$2\frac{1}{16}$ (52)	$1\frac{1}{2}$ (38)	$\frac{1}{4}$ (6.2)	25

IN (MM)



DOOR STOPS WITH HOLDER

GENERAL HARDWARE

FLOOR-MOUNTED DOOR STOP

R472, R473



R472 C26D

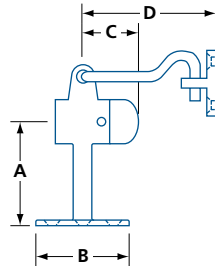

- For exterior / interior use
- Solid brass
- Non-marking rubber tip
- Mounting hardware included:
 - #R472 - wood screws
 - #R473 - lead shielding, masonry anchor, wood screws
- #R470REP - Replacement rubber tip

MODEL	FINISH	A	øB	C	D	/BOX
R472	C26D, C3	2½ (64)	2¾/16 (56)	1¾/16 (33.3)	2¾/4 (70)	10
R473	C26D, C3	2½ (64)	2¾/16 (56)	1¾/16 (33.3)	2¾/4 (70)	10

IN (MM)

HEAVY DUTY FLOOR-MOUNTED STOP WITH HOOK

DC540



DC540

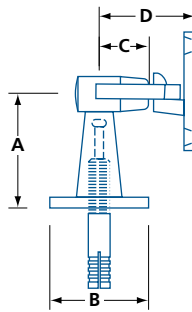

- For heavy-duty interior / exterior use
- Heavy-duty zinc die-cast
- Non-marking rubber tip
- Concealed mounting
- Mounting hardware included:
 - #DC540 - masonry anchor, wood screws
 - #DC540W - wood screws
- #DC540REP - Replacement rubber tip

MODEL	FINISH	A	øB	C	D	/BOX
DC540	Satin chrome	2 (50.8)	1¾/4 (44.5)	1¾/32 (28)	1¾/4 (44.5)	10
DC540W	Satin chrome	2 (50.8)	1¾/4 (44.5)	1¾/32 (28)	1¾/4 (44.5)	10

IN (MM)

DOOR STOPS WITH HOLDER

GENERAL HARDWARE

WALL-MOUNTED DOOR STOP

R476, R477



R476 C26D

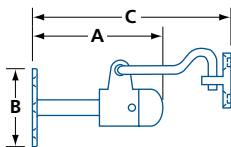

- For exterior / interior use
- Solid brass
- Non-marking rubber tip
- Mounting hardware included:
 - #R476 - wood screws
 - #R477 - lead shielding, masonry anchor, wood screws

#R470REP - Replacement rubber tip

MODEL	FINISH	A	øB	C	/BOX
R476	C3, C26D	3½ (89)	2¾ (56)	5¼ (133.4)	12
R477	C26D	3½ (89)	2¾ (56)	5¼ (133.4)	12

IN (MM)

HEAVY-DUTY WALL-MOUNTED DOOR STOP WITH HOOK

DCX20



DCX20

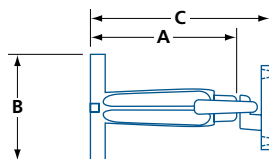

- For heavy-duty interior / exterior use
- Heavy duty zinc die-cast
- Non-marking rubber tip
- Conceal mounting
- Mounting hardware included: masonry anchors, machine screws

MODEL	FINISH	A	øB	C
DCX20	Satin chrome	4⅞ (124)	3½ (89)	5¾ (146)

IN (MM)



DOOR HOLDERS

GENERAL HARDWARE

FRICITION DOOR HOLDER – WALL MOUNTED

DC23D

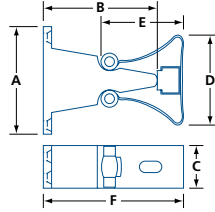
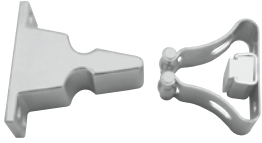

- For interior use
- Zinc die-cast, steel clamp
- Mounting hardware included: wood screws

MODEL	FINISH	A	B	C	D	E	F
DC23D	Zinc Plated	2 ⁵ / ₈ (67)	2 ⁹ / ₁₆ (65)	1 (25.4)	2 ¹ / ₈ (54)	1 ¹⁵ / ₁₆ (49)	3 ¹ / ₈ (79)

IN (MM)

FRICITION DOOR HOLDER - FLOOR MOUNTED

DC24D

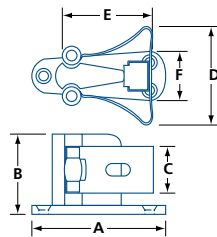

- For interior use
- Zinc die-cast, steel clamp
- Mounting hardware included: wood screws

MODEL	FINISH	A	B	C	D	E	F
DC24D	Satin Chrome	2 ¹⁵ / ₁₆ (75)	1 ³ / ₄ (44.5)	1 ⁹ / ₁₆ (23.8)	2 ¹ / ₈ (54)	1 ¹⁵ / ₁₆ (54)	1 ¹ / ₈ (28.6)

IN (MM)

DOOR HOLDERS

GENERAL HARDWARE

PLUNGER TYPE DOOR HOLDER

1014.02



1014.02

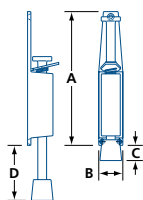

- Heavy duty zinc die-cast
- Non-marking rubber tip

#1024.00 - Replacement rubber tip for #1014.02
 #1015REP - Replacement rubber tip for #1015.02

MODEL	FINISH	A	B	C	D	/BOX
1014.02	Silver Paint	4 ³ / ₄ (121)	1 (25.4)	³ / ₈ (9.5)	1 ⁵ / ₈ (41.3)	6
1015.02	Silver Paint	6 ¹ / ₂ (165)	1 ³ / ₁₆ (30.2)	⁷ / ₁₆ (11.1)	2 ³ / ₈ (60)	6

IN (MM)

PLUNGER TYPE DOOR HOLDER

1024.02

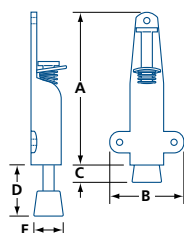

- Steel construction
- Non-marking rubber tip

#1024.00 - Replacement rubber tip

MODEL	FINISH	A	B	C	D	E
1024.02	Silver Paint	4 ³ / ₈ (111)	2 ¹ / ₈ (54)	¹¹ / ₁₆ (17.5)	1 ³ / ₄ (44.5)	⁷ / ₈ (22.2)

IN (MM)

PLUNGER TYPE DOOR HOLDER

1026.02

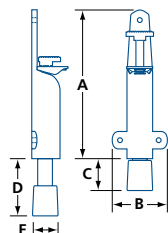

- Steel construction
- Non-marking rubber tip

#1026.00 - Replacement rubber tip

MODEL	FINISH	A	B	C	D	E
1026.02	Silver Paint	6 ³ / ₄ (172)	2 ¹ / ₂ (63.5)	1 ¹ / ₂ (38.1)	2 ³ / ₄ (70)	1 ¹ / ₈ (28.6)

IN (MM)



DOOR HOLDERS

GENERAL HARDWARE

KICK-DOWN DOOR HOLDERS

1060, 1076, 659-660, 17, 18-5



1060.02



1076.02



659-660

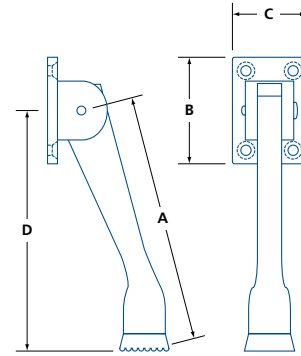

MODEL	FINISH	MATERIAL	A	B	C	D	REPLACEMENT TIP	SCREWS*	/BOX
1060.02	Silver Paint	Zinc die-cast	5 (127)	4 (102)	1 (25.4)	4 ⁷ / ₈ (124)	—	—	8
1076.02	Silver Paint	Steel	4 ¹ / ₄ (108)	2 ³ / ₈ (60)	1 ³ / ₁₆ (20.6)	4 ¹ / ₄ (108)	#1076.00	—	10
659-660	Satin Stainless Steel	Brass	4 ¹ / ₁₆ (103)	2 (50.8)	1 ³ / ₈ (34.9)	3 ³ / ₄ (95.25)	—	—	50

IN (MM) (*) SCREWS NOT INCLUDED



17 C26D



18-5 C26D

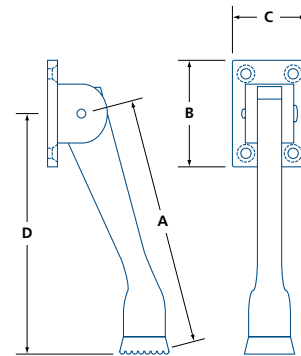

MODEL	FINISH	MATERIAL	A	B	C	D	REPLACEMENT TIP	SCREWS*	/BOX
17	C3, C26D	Zinc die-cast	5 (127)	2 (50.8)	1 ³ / ₈ (34.9)	4 ³ / ₄ (121)	#17REP	Wood	10
18-5	C20D, C26D	Brass	5 (127)	2 (50.8)	1 ³ / ₈ (34.9)	4 ³ / ₄ (121)	#18REP	Wood	12

IN (MM) (*) SCREWS INCLUDED

DOOR HOLDERS

GENERAL HARDWARE

KICK-DOWN DOOR HOLDER

604, 606, 608, 610, 612



MODEL	FINISH	MATERIAL	A	B	C	D	REPLACEMENT TIP	SCREWS*	/BOX
604	C2G, C3	Steel	4 (102)	3 (76)	1 $\frac{5}{8}$ (41.3)	3 $\frac{7}{8}$ (98)	#208G	Wood	10
606	C2G, C3	Steel	6 (152)	3 (76)	1 $\frac{5}{8}$ (41.3)	5 $\frac{7}{8}$ (149)	#208G	Wood	10
608	C2G	Steel	8 (203)	3 (76)	1 $\frac{5}{8}$ (41.3)	7 $\frac{7}{8}$ (200)	#208G	Wood	10
610	C2G	Steel	10 (254)	3 (76)	1 $\frac{5}{8}$ (41.3)	9 $\frac{3}{4}$ (248)	#208G	Wood	10
612	C2G	Steel	12 (305)	3 (76)	1 $\frac{5}{8}$ (41.3)	11 $\frac{3}{4}$ (298)	#208G	Wood	10

IN (MM) (*) SCREWS INCLUDED



DOOR HOLDERS

GENERAL HARDWARE

MAGNETIC DOOR HOLDER AND STOP

CH401

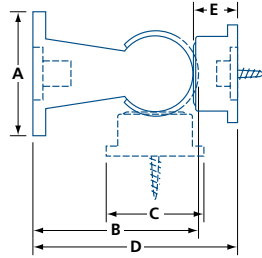

- Quality nylon construction
- Floor or wall mountable
- Concealed mounting
- Mounting hardware included: wood screw, masonry nail

MODEL	FINISH	A	B	C	D	E	/CASE
CH401	B, AW	2 ¹ / ₈ (54)	2 ⁷ / ₈ (73)	1 ¹¹ / ₁₆ (42.9)	3 ¹ / ₂ (89)	³ / ₄ (19.1)	10

IN (MM)

MAGNETIC DOOR HOLDER AND STOP

MDH, SMDH



SOSS

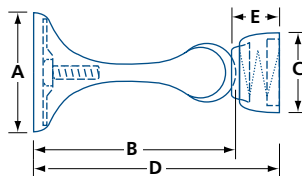

- Floor or wall mountable
- Zinc die-cast material
- Spring loaded stop
- Concealed mounting
- Mounting hardware included: wood screws

MODEL	FINISH	A	B	C	D	E	/CASE
MDH	C15, C19, C26D, C3	1 ³ / ₄ (44.5)	3 (76)	1 ³ / ₁₆ (30)	3 ⁵ / ₈ (93)	³ / ₄ (19)	10
SMDH	C15, C19, C26D, C3	1 ³ / ₄ (44.5)	3 (76)	1 ³ / ₁₆ (30)	3 ⁵ / ₈ (93)	³ / ₄ (19)	10

IN (MM)

MDH C26D

CHECK CHAINS

GENERAL HARDWARE

CHECK CHAINS

3548, 3550



3548



3550

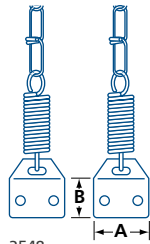

3548

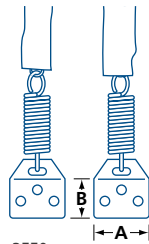

3550

- Prevents damage to the door or door hardware from wind gusts
- For screen doors and/or storm doors
- Steel chain
- Two tension coil springs
- Stamped steel mounting brackets, zinc plated
- Mounting hardware included: wood screws

#3550 - Includes grey vinyl cover

MODEL	FREE LENGTH	MAX DOOR WIDTH	A	B	PER BOX
3548	25½ (648)	36 (914)	1¾ (30)	¾ (19)	25
3550	27½ (698.5)	42 (1067)	1¼ (31.8)	1⅝ (28.5)	10

IN (MM)

COMMERCIAL CHECK CHAINS

3560, 3561



3560

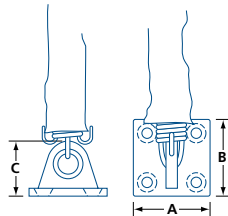

- Prevents damage to door and/or door hardware from wind gusts
- For commercial or heavy duty doors
- Heavy-duty welded chain
- Two assembled compression coil springs at both end
- Zinc die-cast mounting brackets, zinc plated
- Grey vinyl cover
- Mounting hardware included: wood screws

MODEL	FREE LENGTH	MAX DOOR WIDTH	A	B	C	PER BOX
3560	25 (635)	36 (914)	1½ (38)	1½ (38)	1⅝ (28.6)	6
3561	32 (813)	42 (1067)	1½ (38)	1½ (38)	1⅝ (28.6)	6

IN (MM)

HEAVY DUTY COMMERCIAL CHECK CHAIN

3562



3562

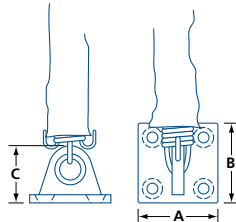

- Prevents damage to door and/or door hardware from wind gusts
- For commercial or heavy duty doors exposed to high or frequent wind gusts
- Extra heavy-duty welded chain
- Two heavy-duty coil springs with stainless steel linkage
- Brass die-cast mounting brackets, satin chrome finish
- Grey textured vinyl cover
- Mounting hardware included: wood screws

MODEL	FREE LENGTH	MAX DOOR WIDTH	A	B	C	PER BOX
3562	32½ (825.5)	48 (1219)	1¾ (39.7)	1¾ (39.7)	1¾ (30.2)	6

IN (MM)

MAIL SLOTS

GENERAL HARDWARE

DraftGuard INSULATED MAIL SLOT – DELUXE

46100, 46200

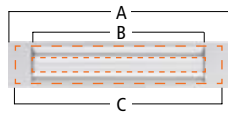

	46100	46200
(A) Front	12 ⁷ / ₃₂ x 3 ⁹ / ₃₂ (310 x 80)	15 ³ / ₄ x 3 ⁹ / ₃₂ (400 x 80)
(B) Slot Size	9 ⁹ / ₃₂ x 1 ³ / ₁₆ (236 x 30)	12 ¹⁹ / ₁₆ x 1 ³ / ₁₆ (325 x 30)
(C) Door cut-out	11 ¹³ / ₁₆ x 2 ³ / ₄ (300 x 70)	15 ¹ / ₁₆ x 2 ³ / ₄ (389 x 70)

IN (MM)

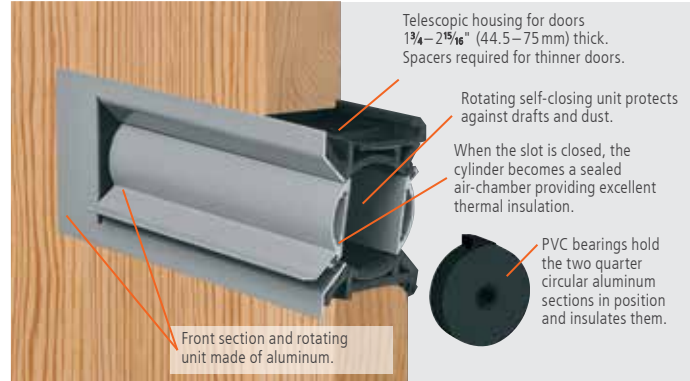

- Fully insulated housing; with rotating self-closing aluminum flaps
- Fully enclosed air chamber stops drafts, dust and reduces noise
- Telescopic housing for doors 1³/₄–2¹⁵/₁₆" (44.5–75 mm) thick Spacers required for thinner doors (see below)
- Available in wide format to accommodate large envelopes
- Soft rubber weather exterior seal
- Insulating gaskets in all critical areas





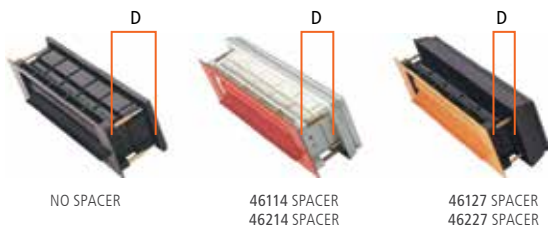



FRAME SPACERS

For doors less than 1³/₄in (44.5mm) thick.



THICKNESS (D)	46100	46200
1 ³ / ₄ – 2 ¹⁵ / ₁₆ (44.5–75)	—	—
1 ³ / ₁₆ – 2 ¹³ / ₃₂ (30–61)	#46114BLACK #46114WHITE	#46214BLACK #46214WHITE
2 ¹ / ₃₂ – 1 ⁷ / ₈ (17–48)	#46127BLACK #46127WHITE	#46227BLACK #46227WHITE

IN (MM)

-  #461001 Anodized satin silver with black frame and housing
#462001 (wide format)
-  #461004 Anodized medium bronze with black frame and housing
#462004 (wide format)
-  #461005 Anodized dark bronze with black frame and housing
#462005 (wide format)
-  #461006 Anodized brass with black frame and housing
#462006 (wide format)
-  #461007 Powder coated white with white frame and housing
#462007 (wide format)
-  #461010 Powder coated black with black frame and housing
#462010 (wide format)
-  #461011 Anodized satin nickel with black frame and housing
#462011 (wide format)
-  #461012 Matte black with black frame and housing
#462012 (wide format)

(*) OTHER COLOURS / FINISHES AVAILABLE BY SPECIAL ORDER.
PLEASE CONTACT YOUR LOCAL REPRESENTATIVE

MAIL SLOTS

GENERAL HARDWARE

DraftGuard INSULATED MAIL SLOT

46500

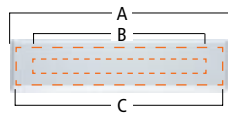
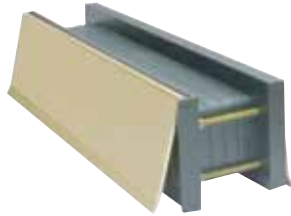

	REGULAR	WITH EXTENSION*
(A) Front	11 ⁷ / ₈ x 2 ³ / ₄ (302 x 70)	—
(B) Slot Size	10 x 1 ¹ / ₂ (254 x 38)	—
(C) Door cut-out	11 ¹ / ₈ x 2 (280 x 51)	11 ¹ / ₄ x 2 (286 x 51)

IN (MM) (*) EXTENSION MUST BE USED WITH DOORS OVER 1³/₄ IN (44.5 MM) THICK AND SLOT MUST BE CUT WITH FINE-TOOTH SAW.

- Self-closing interior and exterior anodized aluminum flaps
- Fully enclosed tough plastic housing
- Telescopic housing for doors up to 1³/₄" (44.5 mm) thick
- Up to 4¹/₄" (108 mm) with extension (sold separately)
- Soft rubber weather exterior seal
- Insulating gaskets in all critical areas



#465001..... Aluminum

#465005..... Dark Bronze

#465006..... Brass

#465007..... White



#465000..... Slot extension.
For doors 1³/₄–4¹/₄" (44.5–108 mm)

#465000L..... Screw pack for slot extension

#465000R..... Replacement screws for mail slot



SIGNAGE

GENERAL HARDWARE

PICTOGRAM SIGNAGE – SMALL

S801, S802, S803, S804

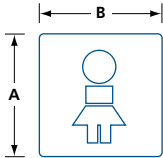

- Stainless steel pictogram signs
- Self-adhesive
- Packaged & sold individually

MODEL	DESCRIPTION	A	B
S801-630	Women		
S802-630	Men	2 ¹⁵ / ₁₆	2 ¹⁵ / ₁₆
S803-630	Unisex	(75)	(75)
S804-630	Disabled		

IN (MM)

PICTOGRAM SIGNAGE

S901, S902, S903, S904

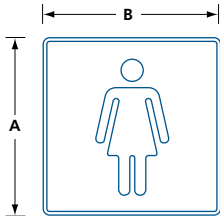

- Stainless steel pictogram signs
- Plastic mounting plate
- Packaged & sold individually
- Wood screws included

MODEL	DESCRIPTION	A	B
S901-630	Women		
S902-630	Men	6 ⁷ / ₁₆	6 ⁷ / ₁₆
S903-630	Unisex	(164)	(164)
S904-630	Disabled		

IN (MM)

DOOR SWEEPS

GENERAL HARDWARE

DOREX DOOR SWEEP WITH NYLON BRUSH

DGS-WAD

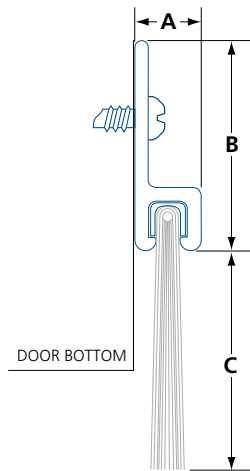

- cULus listed (UL10C)
 - » Wood fire door: 20 min
 - » Composite fire door: 90 min
 - » Metal fire door: 3 hrs
- Surface mounted
- Reduces infiltration of drafts, moisture, air, insects, and dust
- Extruded aluminum profile
- Flexible nylon brush conforms to surface irregularities
- Remains flexible between -40 to 205°C (-40 to 401°F)
- Can be cut to required length
- Includes screws for wood and metal doors

MODEL	FINISH	A	B	C	LENGTH
DGS-WAD380B-36	Mill Aluminum	1/4 (6.4)	7/8 (22.2)	1 (25.4)	36 (914)
DGS-WAD380B-48					48 (1219)
DGS-WDD380B-36	Dark Bronze	(6.4)	(22.2)	(25.4)	36 (914)
DGS-WDD380B-48					48 (1219)

IN(MM)

DOREX DOOR SWEEP WITH NYLON BRUSH AND RAIN DRIP

DGS-WAR

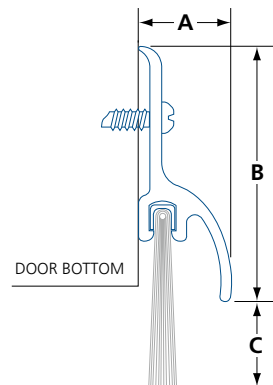

- cULus listed (UL10C)
 - » Wood fire door: 20 min
 - » Composite fire door: 90 min
 - » Metal fire door: 3 hrs
- Surface mounted
- Reduces infiltration of drafts, moisture, air, insects, and dust
- Rain drip deflects water and prevents seepage through the gap under doors
- Extruded aluminum profile
- Flexible nylon brush conforms to surface irregularities
- Remains flexible between -40 to 205°C (-40 to 401°F)
- Can be cut to required length
- Includes screws for wood and metal doors

MODEL	FINISH	A	B	C	LENGTH
DGS-WAR480B-36	Mill Aluminum	1/2 (12.7)	1 1/4 (31.8)	3/8 (9.5)	36 (914)

IN(MM)

DOOR SWEEPS

GENERAL HARDWARE

DOREX DOOR SWEEP WITH NEOPRENE SEAL

DGS-WA210, WD210

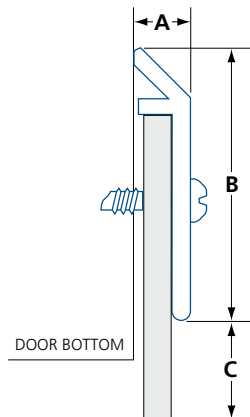

- cULus listed (UL10C)
 - » Metal fire door: 3 hrs
- Surface mounted
- Reduces infiltration of drafts, moisture, air, insects, and dust
- Extruded aluminum profile
- Neoprene blade
- Remains flexible between -20 to 50°C (-4 to 122°F)
- Can be cut to required length
- Includes screws for metal doors

MODEL	FINISH	A	B	C	LENGTH
DGS-WA210N-36	Mill Aluminum	1/4 (6.34)	1 1/4 (31.8)	9/16 (14.3)	36 (914)
DGS-WA210N-48					48 (1219)
DGS-WD210N-36	Dark Bronze	1/4 (6.34)	1 1/4 (31.8)	9/16 (14.3)	36 (914)
DGS-WD210N-48					48 (1219)

IN(MM)



DOOR BOTTOMS

GENERAL HARDWARE

DOREX AUTOMATIC DOOR BOTTOMS, HOLLOW METAL DOORS

DGS-BA32V

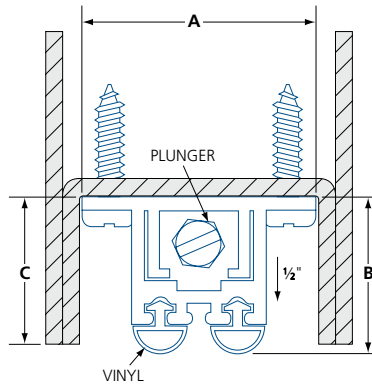

- cULus listed (UL10C)
 - » Wood fire door: 20 min
 - » Composite fire door: 90 min
 - » Metal fire door: 3 hrs
- Automatic door bottom for hollow metal doors with inverted channel
- Door seal will lower automatically as the door closes
- Extruded aluminum rail
- Non handed
- Maximum drop: $\frac{1}{2}$ " (12.7 mm), recommended gap is $\frac{3}{8}$ " (9.5 mm)
- Door thickness: $1\frac{3}{4}$ " (44.5 mm)
- Channel depth: $\frac{3}{4}$ " (19 mm)
- Dual vinyl gaskets provide an excellent general-purpose seal
- Door drop can accommodate even and uneven surfaces
- Can be trimmed
- Does not include end-caps, requires a hole for the plunger to extend through the hinge side of the door edge
- Includes screws for metal doors

MODEL	FINISH	A	B	C	LENGTH
DGS-BA32V-36	Anodized Aluminum	$1\frac{3}{8}$ (34.9)	$1\frac{5}{16}$ (23.8)	$\frac{3}{4}$ (19)	36 (914)

IN(MM)

DOREX AUTOMATIC DOOR BOTTOMS, WOOD DOORS

DGS-BA50N

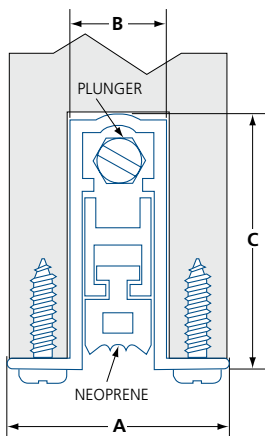

- cULus listed (UL10C)
 - » Wood fire door: 20 min
 - » Composite fire door: 90 min
 - » Metal fire door: 3 hrs
- Automatic door bottom for wood door and mortised channel
- Door seal will lower automatically as the door closes
- Extruded aluminum rail
- Non handed
- Maximum drop: $\frac{3}{4}$ " (19 mm)
- Door thickness: $1\frac{3}{8}$ – $1\frac{3}{4}$ " (35–44.5 mm)
- Recommended channel depth: $1\frac{1}{2}$ " (38 mm), width: $1\frac{9}{32}$ " (15 mm)
- Neoprene gasket provides an excellent general-purpose seal
- Door drop can accommodate even and uneven surfaces
- Can be trimmed
- Includes endcaps and screws for metal and wood doors
- On fire doors, the door bottom mortise preparation must be done by the door manufacturer

MODEL	FINISH	A	B	C	LENGTH
DGS-BA50N-36	Anodized Aluminum	$1\frac{5}{16}$ (33)	$\frac{9}{16}$ (14.2)	$1\frac{7}{16}$ (36.6)	36 (914)

IN(MM)

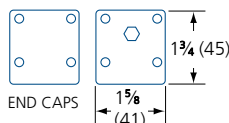

PERIMETER GASKETS

GENERAL HARDWARE

DOREX PERIMETER GASKETING

DGS-SA14V

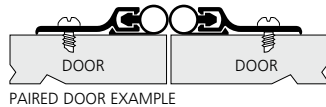
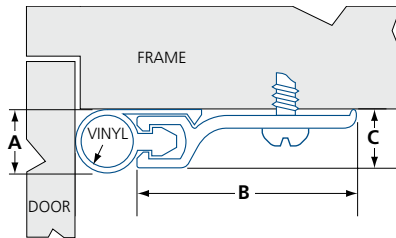

- cULus listed (UL10C)
 - » Wood fire door: 20 min
 - » Composite fire door: 90 min
 - » Metal fire door: 3 hrs
- Surface mounted
- For use on a wood or metal door frame of a 3x7ft (91.4x213.4cm) door
- For gaps between 1/16–1/4" (2–6 mm)
- Temperature range: -35 to 120°C (-31 to 248°F)
- Extruded aluminum profile
- Vinyl gasket, provides an excellent general-purpose seal
- Can be installed on the face of a door to fill gaps between paired doors
- Slotted holes for easy adjustment
- Can be cut to required length
- Includes screws for wood and metal door frames
- Supplied in 3 pieces: 2x7 ft (213.4 cm), 1x3 ft (91.4 cm)

MODEL	FINISH	A ¹	B	C	LENGTH
DGS-SA14V-17	Mill Aluminum	1/4 (6.4)	7/8 (22.2)	1/4 (6.4)	204 (5080)

IN(MM) (1) NON-COMPRESSED

DOREX ADHESIVE GASKETING

DGS-SB12S

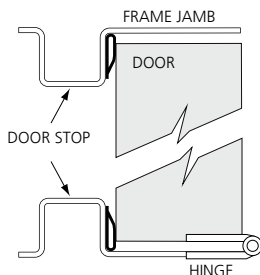
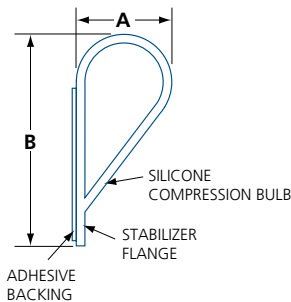

- cULus listed (UL10C)
 - » Wood fire door: 20 min
 - » Composite fire door: 90 min
 - » Metal fire door: 3 hrs
- Silicone gasket with permanent adhesive strip
- Surface mounted
- For use on wood or metal door frames
- Compresses to fill gaps between 1/16–1/4" (2–6 mm)
- Provides an excellent general-purpose seal
- Extruded high-temperature silicone, self-extinguishing and non-toxic
- Effective between -50 to 232°C (-58 to 450°F)
- Impervious to fungus, mold, and mildew
- Unaffected by sunlight, ozone, and ultraviolet rays
- Coil length of 17ft (50.8cm) is sufficient for a door frame for a 3x7ft (91.4x213.4cm) door
- Can be cut to required length
- Other lengths available by special order

MODEL	FINISH	A ¹	B	LENGTH ²
DGS-SB12S-17	Black	1/4 (6.4)	1/2 (12.7)	204 (5080)

IN(MM) (1) NON-COMPRESSED (2) COIL LENGTH



DOOR ASTRAGAL

GENERAL HARDWARE

DOREX T-ASTRAGAL

DGS-AA158V



- cULus listed (UL10C)
 - » Metal fire door: 3 hrs
- Surface mounted on the beveled door edge of the active door of paired doors
- Provides a general-purpose weather seal
- Extruded aluminum profile
- Eco-friendly, bio-based gasket
- Can be cut to required length
- Includes screws for wood and metal door frames
- Door coordinator may be required when using two active doors
- Temperature range -5 to 60°C (-23 to 140°F)

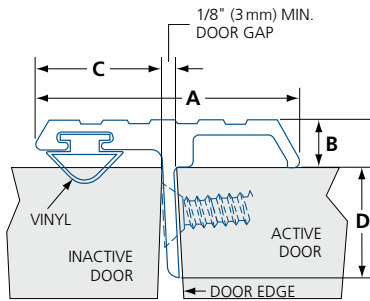

MODEL	FINISH	A	B	C	D	LENGTH
DGS-AA158V-7	Mill Aluminum	1 ³ / ₈ (35)	1/4 (6.4)	2 ¹ / ₃₂ (16.8)	9/16 (14.5)	84 (2134)

IN(MM)

FLUSH BOLTS

GENERAL HARDWARE

MANUAL EXTENSION FLUSH BOLT – FIRE RATED

FBUL100

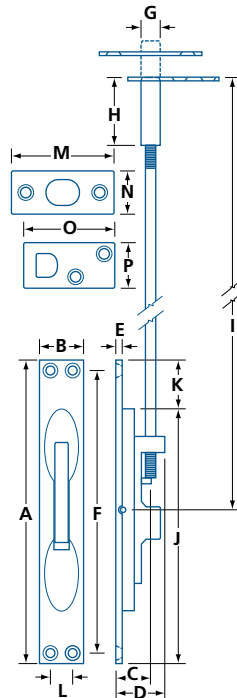

- cULus listed for use with hollow metal, metal clad, steel covered composite, flush type sheet or metal swinging type fire doors.
- Not for wood fire doors
- Fits metal door preparation per ANSI A115.4-206
- Brass and steel components
- Throw: 3/4" (19mm)
- Adjustable rod up to 7/8" (22.2 mm)
- Supplied with guide, strike plate and 12" (305 mm) 1/4-20 UNC threaded rod (see dimension "I")
- Mounting hardware included: combination machine-wood screws
- Optional rods available (not pictured):
 - #FBUL100R16 18" (457.2 mm) optional threaded rod
 - #FBUL100R22 24" (609.6 mm) optional threaded rod

MODEL	FINISH	A	B	C	D	E	F	G	H	I	J	K	L	M	N	O	P
FBUL100	15, 26D 19	6 3/4 (171)	1 (25.4)	3/4 (19.1)	1 (25.4)	1/8 (3.2)	6 1/4 (158.8)	1/2 (12.7)	1 1/2 (38.1)	12 (305)	5 3/4 (146)	1 (25.4)	1/2 (12.7)	2 1/4 (57)	1 5/16 (23.8)	2 (50.8)	1 (25.4)

IN (MM)

FLUSH BOLTS

GENERAL HARDWARE

MANUAL EXTENSION FLUSH BOLT

DC840, 8402

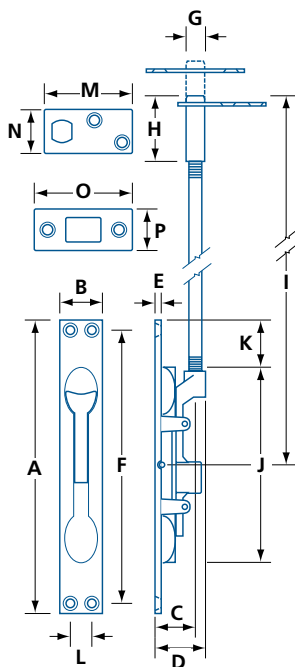

- Supplied with guide, strike plate and 12" (305mm) $\frac{1}{16}$ -18 UNC threaded rod
- Fits metal door preparation per ANSI A115.4-1981
- Zinc-diecast and steel components
- Mounting hardware included: machine and wood screws

#DC840 has a $\frac{5}{8}$ " (15.9mm) throw and $+\frac{5}{8}$ " (15.9mm) adjustment

#8402 has a $\frac{1}{2}$ " (12.7mm) throw and $\pm\frac{1}{4}$ " (6.4mm) adjustment

MODEL	FINISH	A	B	C	D	E	F	G	H	I	J	K	L	M	N	O	P	/UNIT
DC840	C3, C15	6 $\frac{3}{4}$ (171)	1 (25.4)	$\frac{3}{4}$ (19.1)	1 (25.4)	$\frac{9}{64}$ (3.6)	6 $\frac{1}{4}$ (158.8)	$\frac{7}{16}$ (11.1)	1 $\frac{1}{2}$ (38.1)	12 (305)	4 $\frac{3}{4}$ (111)	1 (25.4)	$\frac{1}{2}$ (12.7)	2 (50.8)	1 (25.4)	2 $\frac{1}{4}$ (57)	1 $\frac{5}{16}$ (23.8)	2
8402	C3, C5, C10B, C26D	6 $\frac{3}{4}$ (171)	1 (25.4)	$\frac{3}{4}$ (19.1)	1 (25.4)	$\frac{9}{64}$ (3.6)	6 $\frac{1}{4}$ (158.8)	$\frac{1}{2}$ (12.7)	1 $\frac{1}{2}$ (38.1)	12 (305)	4 $\frac{9}{16}$ (116)	1 (25.4)	$\frac{1}{2}$ (12.7)	2 (50.8)	1 (25.4)	2 $\frac{1}{4}$ (57)	1 $\frac{5}{16}$ (23.8)	2

IN (MM)



FLUSH BOLTS

GENERAL HARDWARE

MANUAL EXTENSION FLUSH BOLT

DC860, DC861

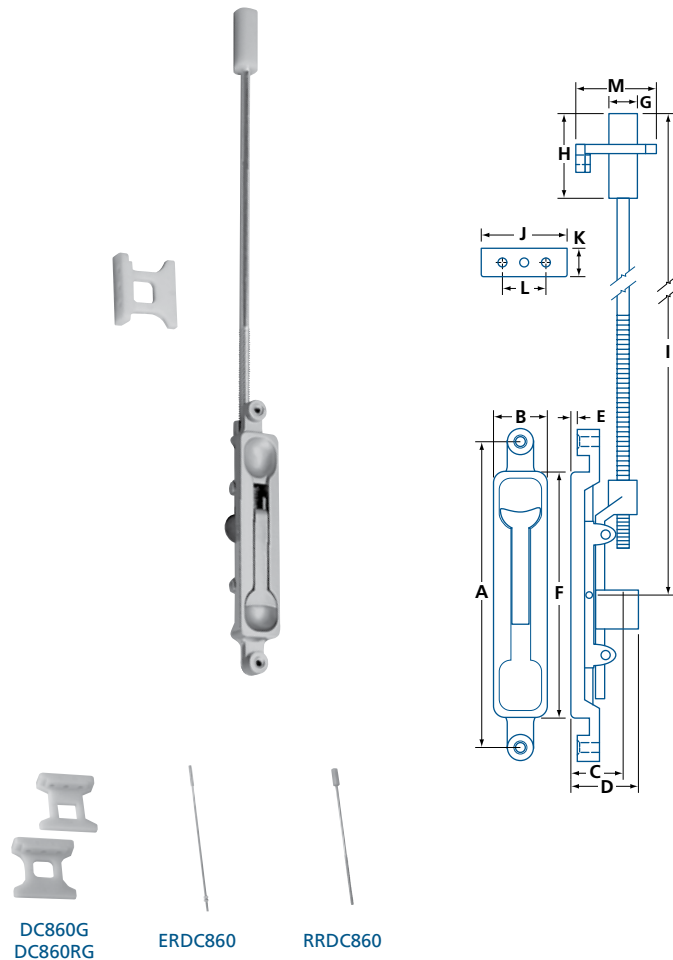

- Single bolt for aluminum doors
- $\frac{1}{8}$ " (3 mm) or $\frac{1}{4}$ " (6 mm) offset
- Throw: $\frac{5}{8}$ " (16 mm)
- Flush bolt faceplate with $\frac{5}{32}$ " (4 mm) radius corners
- Zinc die-cast and steel components
- Mounting hardware included: machine screws
- Supplied with threaded adaptor bushing and locking nuts
- Supplied with:
 - #RRDC860 12" (305 mm) Replacement rod
 - #ERDC860 12" (305 mm) $\frac{1}{4}$ -20 UNC extension rod
 - #DC860G / #DC860RG Nylon guides

MODEL	FINISH	A	B	C	D	E	F	G	H	I	J	K	L	M	/BOX
DC860	C20D, C28	$\frac{5}{4}$ (133)	$\frac{15}{16}$ (23.8)	$\frac{13}{16}$ (20.6)	$\frac{1}{8}$ (28.6)	$\frac{1}{8}$ (3.2)	$\frac{4}{4}$ (108)	$\frac{1}{2}$ (12.7)	$\frac{1}{2}$ (38)	12 (305)	$\frac{1}{2}$ (38)	$\frac{1}{2}$ (12.7)	$\frac{3}{4}$ (19.1)	$\frac{13}{8}$ (34.9)	10
DC861	C20D, C28	$\frac{5}{4}$ (133)	$\frac{15}{16}$ (23.8)	$\frac{13}{16}$ (20.6)	$\frac{1}{8}$ (28.6)	$\frac{1}{4}$ (6.2)	$\frac{4}{4}$ (108)	$\frac{1}{2}$ (12.7)	$\frac{1}{2}$ (38)	12 (305)	$\frac{1}{2}$ (38)	$\frac{1}{2}$ (12.7)	$\frac{3}{4}$ (19.1)	$\frac{13}{8}$ (34.9)	10

IN (MM)

FLUSH BOLTS

GENERAL HARDWARE

AUTOMATIC EXTENSION FLUSH BOLT

FB610M

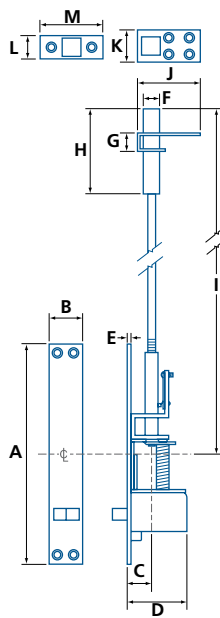

- cULus labeled and rated only for hollow metal doors up to and including 3 hrs. Conforms to UL 10C and UBC 7-2-1997
- Top and bottom flush bolts for use on metal doors measuring up to 4 ft. (1219mm) wide and 8 ft. (2438mm) high
- Fits standard and ANSI preparation for metal doors
- Steel components
- Fully automatic, when active door is opened, inactive door is free
- Maintains inactive door locked in case of fire
- Supplied with bolt guide and door strike
- Mounting hardware included: machine and combination Machine-wood screws

MODEL	FINISH	A	B	C	D	E	F	G	H	I	J	K	L	M
FB610M	32D	6 ³ / ₄ (171)	1 (25.4)	3 ⁴ / ₄ (19.1)	1 ⁷ / ₈ (47.6)	1 ¹ / ₈ (3.2)	1 ¹ / ₂ (12.7)	5 ⁵ / ₈ (15.9)	2 (50.8)	12 (305)	2 (50.8)	1 (25.4)	1 (25.4)	2 ¹ / ₄ (57)

IN (MM)



FLUSH BOLTS

GENERAL HARDWARE

6" BRASS FLUSH BOLT

8123, 8124

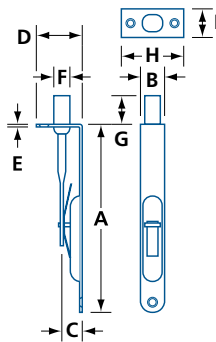

8123

- Made of solid brass and steel materials
- Flush bolt face plate end with $\frac{3}{8}$ " (9.5 mm) radius
- Keeper included
- Mounting hardware included: wood screws

MODEL	FINISH	VAR	A	B	C (BS)	D	E	øF	G	H	I	/BOX
8123	C11P	-1	6 (152)	$\frac{3}{4}$ (19.1)	$\frac{1}{2}$ (12.7)	$1\frac{1}{4}$ (31.6)	$\frac{5}{64}$ (2)	$\frac{1}{2}$ (12.7)	1 (25.4)	2 (50.8)	$\frac{7}{8}$ (22.2)	25
8123	C19	-2	$5\frac{7}{8}$ (149.3)	$\frac{3}{4}$ (19.1)	$\frac{1}{2}$ (12.7)	$1\frac{1}{4}$ (31.6)	$\frac{5}{64}$ (2)	$\frac{1}{2}$ (12.7)	1 (25.4)	2 (50.8)	$\frac{7}{8}$ (22.2)	25
8123	C15, C26D	-2	$5\frac{7}{8}$ (149.3)	$\frac{3}{4}$ (19.1)	$\frac{1}{2}$ (12.7)	$1\frac{1}{4}$ (31.6)	$\frac{5}{64}$ (2)	$\frac{1}{2}$ (12.7)	1 (25.4)	2 (50.8)	$\frac{7}{8}$ (22.2)	25

IN (MM)

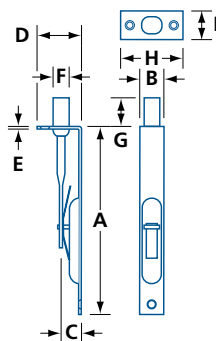

8124

- Made of solid brass and steel materials
- Keeper included
- Mounting hardware included: wood screws

MODEL	FINISH	A	B	C (BS)	D	E	øF	G	H	I	/BOX
8124	C26, C3	6 (152)	$\frac{3}{4}$ (19.1)	$\frac{1}{2}$ (12.7)	$1\frac{1}{4}$ (32)	$\frac{5}{64}$ (2)	$\frac{1}{2}$ (12.7)	1 (25.4)	2 (50.8)	$\frac{7}{8}$ (22.2)	25

IN (MM)

FLUSH BOLTS

GENERAL HARDWARE

4" BRASS FLUSH BOLT

8125

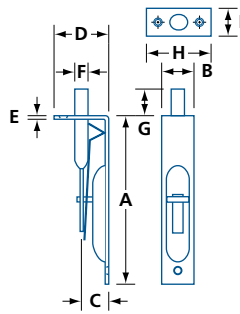

- Made of solid brass and steel materials
- Keeper included
- Mounting hardware included: wood screws

MODEL	FINISH	A	B	C (BS)	D	E	øF	G	H	I	/BOX
8125	C26	4 (102)	¾ (19.1)	1 15/32 (11.9)	1 3/16 (30.2)	5/64 (2)	5/16 (7.9)	19/16 (20.6)	1 1/2 (38.1)	5/8 (15.9)	20

IN (MM)

DUST PROOF STRIKE

T840

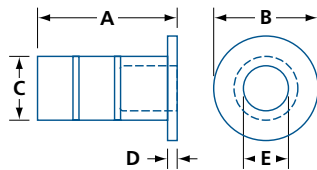

- Aluminum
- Spring loaded plunger
- Strike engagement depth up to ¾" (19mm)

MODEL	FINISH	MATERIAL	A	øB	øC	D	øE	/BOX
T840	C28	Aluminum	1 7/8 (48)	1 3/8 (35)	27/32 (21.4)	1/8 (3.2)	9/16 (14.3)	25

IN (MM)

DUST PROOF STRIKE

DPS, DPSL

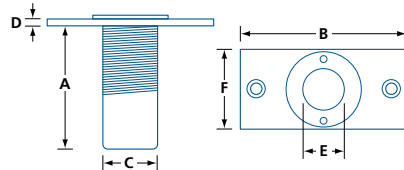
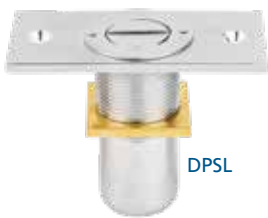

- Stainless steel
- Spring loaded plunger
- Strike engagement depth up to ¾" (19mm)
- Accepts 5/8" (16mm) diameter bolts
- Includes wood screws, plastic anchors
- Includes adjustment tool
- Available with locking (#DPSL) or non-locking (#DPS) plunger

MODEL	FINISH	MATERIAL	A	B	øC	D	øE	F	/BOX	/CASE
DPS/ DPSL	15, 26D	Stainless steel	2 (51)	2 7/8 (73)	3 1/32 (25)	1/8 (3.2)	3/4 (19)	1 3/8 (35)	10	100

IN (MM)



SURFACE BOLTS

GENERAL HARDWARE

BRASS SURFACE BOLT

F779

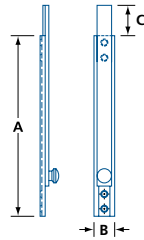

- Two keepers included
- Mounting hardware included: wood screws

MODEL	FINISH	SIZE	MATERIAL	A	B	C	/BOX
F779	C3, C11P, C15, C15A, C19, C26D	4	Brass	4 (102)	1 ¹ / ₁₆ (17.5)	7 ⁷ / ₈ (22.2)	30

IN (MM)

8" COMMERCIAL SURFACE BOLT

0831

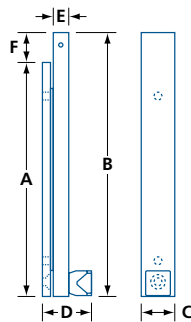

- UL listed
- Both top and bottom strikes included
- Mounting hardware included: wood screws and machine screws

MODEL	FINISH	MATERIAL	A	B	C	D	E	F
0831	Satin chrome	Steel	7 (178)	8 (203)	1 (25.4)	1 ¹ / ₂ (38.1)	1/2 (12.7)	1 (25.4)

IN (MM)

CHAIN BOLT

66

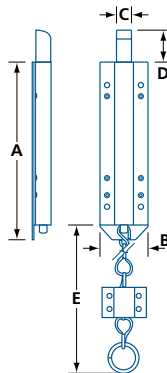

- Heavy-duty chain bolt
- Spring loaded
- Bolt reversible for in-swing and out-swing doors

MODEL	FINISH	MATERIAL	A	B	C SQ	D	E
66	Black	Steel	7 ⁷ / ₈ (187)	2 (50.8)	5 ⁵ / ₈ (15.9)	1 ⁵ / ₁₆ (33.3)	22 (559)

IN (MM)

SURFACE BOLTS

GENERAL HARDWARE

FOOT BOLT

68

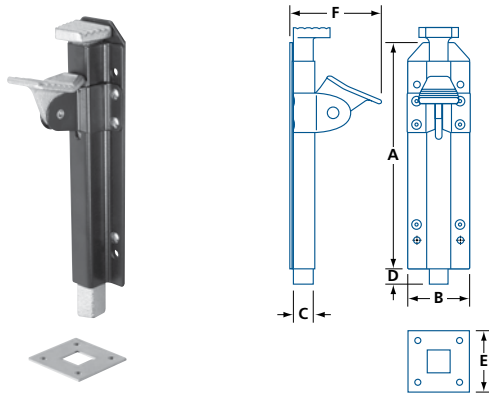

- Cast iron bolt

MODEL	FINISH	MATERIAL	A	B	C SQ	D	E SQ	F
68	Black	Steel	7 ³ / ₈ (187)	2 (50.8)	5 ⁵ / ₈ (15.9)	1 (25.4)	2 (50.8)	2 ⁷ / ₈ (73)

IN (MM)

12" CANE BOLT – HEAVY DUTY

1069

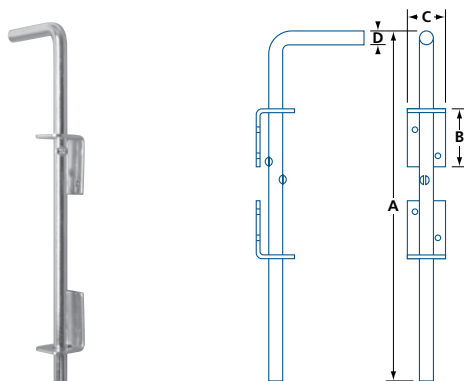

- Mounting hardware included: wood screws

MODEL	FINISH	MATERIAL	A	B	C	D
1069	Zinc plated	Steel	12 (305)	2 (50.8)	1 ⁵ / ₁₆ (33.3)	1 ¹⁵ / ₃₂ (11.9)

IN (MM)



TOWER & BARREL BOLTS

GENERAL HARDWARE

TOWER BOLT

9234

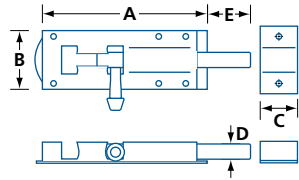

- Steel bolt with groove
- Groove holds bolt in position when installed vertically. Prevents bolt from being shaken loose.

MODEL	FINISH	MATERIAL	A	B	C	∅D	E	/BOX
9234	Epoxy black	Steel	4 $\frac{1}{8}$ (105)	1 $\frac{1}{2}$ (38.1)	1 (25.4)	2 $\frac{5}{64}$ (10)	1 $\frac{1}{4}$ (31.8)	10
9236	Epoxy black	Steel	6 $\frac{1}{8}$ (156)	1 $\frac{1}{2}$ (38.1)	1 (25.4)	2 $\frac{5}{64}$ (10)	1 $\frac{1}{4}$ (31.8)	10
9238	Epoxy black	Steel	8 $\frac{1}{8}$ (206)	1 $\frac{3}{4}$ (44.5)	1 $\frac{3}{8}$ (34.9)	$\frac{1}{2}$ (12.7)	1 $\frac{5}{8}$ (41.3)	10
92310	Epoxy black	Steel	10 $\frac{1}{8}$ (257)	1 $\frac{3}{4}$ (44.5)	1 $\frac{3}{8}$ (34.9)	$\frac{1}{2}$ (12.7)	1 $\frac{5}{8}$ (41.3)	10

IN (MM)

STEEL BARREL BOLT

0711

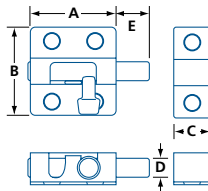
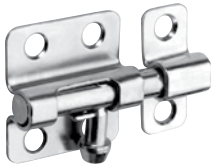

- Mounting hardware included: wood screws

MODEL	FINISH	MATERIAL	A	B	C	∅D	E	/BOX
0711ZP2	Zinc plated	Steel	1 $\frac{3}{8}$ (34.9)	1 $\frac{7}{16}$ (36.5)	$\frac{5}{8}$ (15.9)	$\frac{5}{16}$ (7.9)	$\frac{9}{16}$ (14.3)	20
0711ZP25	Zinc plated	Steel	1 $\frac{3}{4}$ (44.5)	1 $\frac{7}{16}$ (36.5)	$\frac{5}{8}$ (15.9)	$\frac{5}{16}$ (7.9)	$\frac{5}{8}$ (15.9)	12
0711ZP3	Zinc plated	Steel	2 $\frac{1}{8}$ (54)	1 $\frac{7}{16}$ (36.5)	$\frac{5}{8}$ (15.9)	$\frac{5}{16}$ (7.9)	$\frac{3}{4}$ (19.1)	12
0711ZP4	Zinc plated	Steel	3 (76)	1 $\frac{1}{2}$ (38.1)	$\frac{5}{8}$ (15.9)	$\frac{5}{16}$ (7.9)	1 (25.4)	10
0711ZP5	Zinc plated	Steel	3 $\frac{3}{4}$ (95)	1 $\frac{1}{2}$ (38.1)	$\frac{5}{8}$ (15.9)	$\frac{5}{16}$ (7.9)	1 (25.4)	12
0711ZP6	Zinc plated	Steel	4 $\frac{5}{8}$ (117)	1 $\frac{1}{2}$ (38.1)	$\frac{5}{8}$ (15.9)	$\frac{5}{16}$ (7.9)	1 (25.4)	12

IN (MM)

PADBOLTS

GENERAL HARDWARE

STANDARD PADBOLTS

1068, 7210

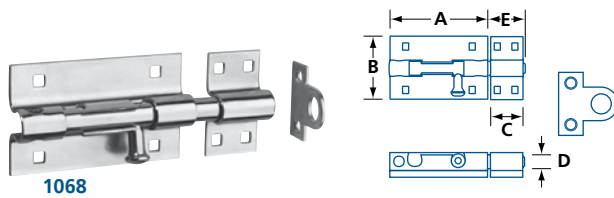

1068

1068

- Durable steel construction
- Includes 2 different bolt keepers
- Accepts shackles up to $\frac{3}{8}$ " (9.5mm)
- $1\frac{3}{4}$ " (45mm) throw
- Mounting hardware included: wood screws

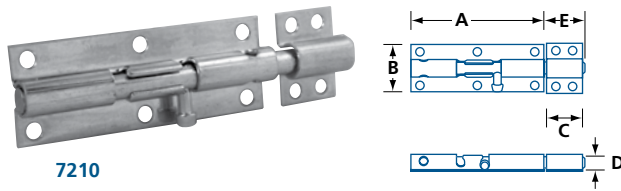

7210

7210

- Durable steel construction
- Accepts shackles up to $\frac{1}{4}$ " (6.4mm)
- $1\frac{1}{4}$ " (32mm) throw
- Mounting hardware included: wood screws

MODEL	FINISH	MATERIAL	A	B	C	∅D	E	MAX PADLOCK SHACKLE DIA	/BOX
GUARD 1068ZP6	Zinc plated	Steel	4½ (114)	2 ¹¹ / ₁₆ (68)	1½ (38.1)	¹⁹ / ₃₂ (15.1)	1 ¹³ / ₁₆ (46)	³ / ₈ (9.5)	5
GUARD 1068ZP8	Zinc plated	Steel	6 (152)	2 ⁵ / ₈ (67)	1½ (38.1)	¹⁹ / ₃₂ (15.1)	1 ¹³ / ₁₆ (46)	³ / ₈ (9.5)	5
7210ZP6	Zinc plated	Steel	4 ⁵ / ₈ (117)	1 ⁵ / ₈ (41.3)	1¼ (31.8)	⁷ / ₁₆ (11.1)	1¼ (31.8)	¹ / ₄ (6.4)	10

IN (MM)

PADBOLTS

GENERAL HARDWARE

BRENTON PADBOLT

1006

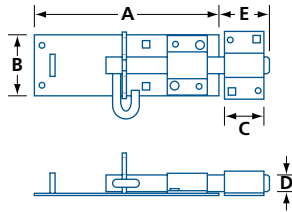

- Durable steel construction
- Accepts shackles up to $\frac{5}{8}$ " (15.9mm)
- 2" (50.8mm) throw
- Heavy duty $\frac{5}{8}$ " (16mm) diameter bolt
- Mounting hardware not included

MODEL	FINISH	MATERIAL	A	B	C	øD	E	MAX PADLOCK SHACKLE DIA
1006	Zinc plated	Steel	6 $\frac{3}{4}$ (171)	2 $\frac{1}{4}$ (57)	1 $\frac{1}{2}$ (38.1)	$\frac{5}{8}$ (15.9)	2 (50.8)	$\frac{5}{8}$ (15.9)

IN (MM)

HEAVY DUTY UTILITY PADBOLT

1419

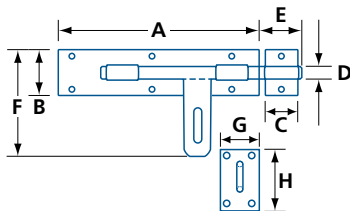

- All new heavy duty design
- Durable steel construction with industrial strength galvanized finish
- Ideal for industrial and agricultural applications
- Accepts shackles up to $\frac{5}{8}$ " (15.9mm) in diameter
- 2 $\frac{3}{4}$ " (70mm) throw for large gaps
- Heavy duty $\frac{5}{8}$ " (15.9mm) diameter bolt
- Mounting hardware not included

MODEL	FINISH	MATERIAL	A	B	C	D	E	F	G	H	MAX PADLOCK SHACKLE DIA
1419	GV	Steel	10 (254)	2 $\frac{1}{2}$ (63.5)	1 $\frac{5}{8}$ (41)	$\frac{5}{8}$ (15.9)	2 $\frac{3}{4}$ (70)	5 $\frac{1}{2}$ (140)	2 (50.8)	3 (76)	$\frac{5}{8}$ (15.9)

IN (MM)



GATE LATCHES

GENERAL HARDWARE

GATE LATCH

278

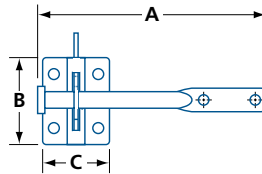
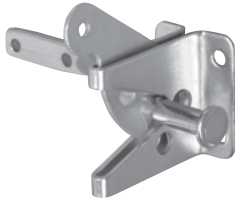

- Mounting hardware included: wood screws

MODEL	FINISH	MATERIAL	A	B	C	MAX PADLOCK SHACKLE DIA	/BOX
278ZP	Zinc plated	Steel	5 (127)	1 ⁷ / ₈ (47.6)	1 ⁷ / ₁₆ (36.5)	1/4 (6.4)	10

IN (MM)

SECRET GATE LATCH

H601

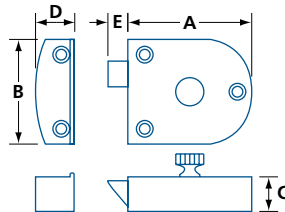
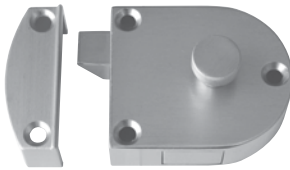

- Mounting hardware included: wood screws

MODEL	FINISH	MATERIAL	A	B	C	D	E	/BOX
H601	C15	Zinc die-cast	2 ¹ / ₄ (57)	1 ¹⁵ / ₁₆ (49.2)	5/8 (15.9)	1 ¹ / ₁₆ (17.5)	3/8 (9.5)	10

IN (MM)

SAFETY HASPS

GENERAL HARDWARE

STANDARD SAFETY HASPS

617

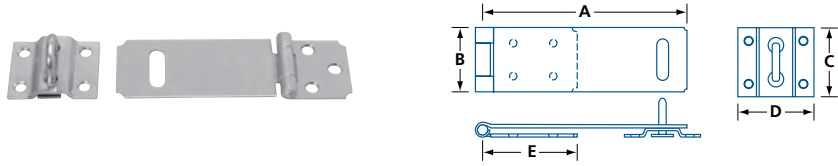

MODEL	FINISH	MATERIAL	A	B	C	D	E	MAX PADLOCK SHACKLE DIA	/BOX
617ZP3	Zinc plated	Steel	3 (76)	1 ¹ / ₈ (28.6)	1 ¹ / ₈ (28.6)	1 ³ / ₈ (35)	1 ⁵ / ₁₆ (23.8)	1/4 (6.3)	12
617ZP35	Zinc plated	Steel	3 ³ / ₈ (85.7)	1 ¹ / ₂ (38.1)	1 ¹ / ₂ (38.1)	1 ¹¹ / ₁₆ (42.9)	1 ¹ / ₄ (31.8)	3/8 (9.5)	12
617ZP45	Zinc plated	Steel	4 ³ / ₈ (111.1)	1 ¹ / ₂ (38.1)	1 ¹ / ₂ (38.1)	1 ³ / ₄ (44.5)	1 ¹ / ₄ (31.8)	3/8 (9.5)	12
617ZP6	Zinc plated	Steel	5 ⁷ / ₈ (149.2)	1 ¹ / ₂ (38.1)	1 ¹ / ₂ (38.1)	1 ³ / ₄ (44.5)	1 ⁵ / ₁₆ (33.3)	3/8 (9.5)	12

IN (MM)

PIVOTING SAFETY HASP

1557

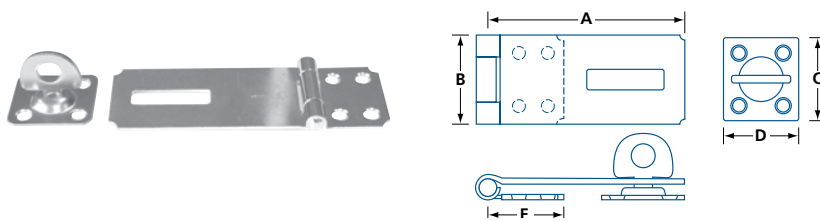

- Staple pivots to vertical or horizontal position
- Mounting hardware included: wood screws

MODEL	FINISH	MATERIAL	A	B	C	D	E	MAX PADLOCK SHACKLE DIA	/BOX
1557ZP35	Zinc plated	Steel	3 ¹ / ₂ (89)	1 ¹ / ₂ (38.1)	1 ¹ / ₄ (31.8)	1 ⁷ / ₁₆ (36.5)	1 ¹ / ₄ (31.8)	3/8 (9.5)	10

IN (MM)

CLOSET HARDWARE

GENERAL HARDWARE

ADJUSTABLE CLOSET ROD

CR

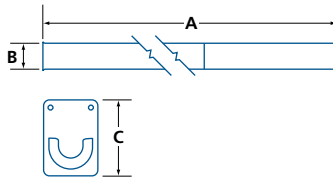

- Adjustable closet rod with wall mounts
- 1" (25.4mm) diameter rod
- Mounting hardware included: wood screws, wall mounts (2) and center support bracket
- Models #CRZP1830 and #CRZP3048 do not include the center support bracket
- Maximum capacity: 40 lbs/12" (18 kg/30 cm)

MODEL	FINISH	MATERIAL	A	B	C	/BOX	/CASE
CRZP1830	Zinc plated	Steel	18 – 30 (460 – 760)				
CRZP3048	Zinc plated	Steel	30 – 48 (760 – 1220)	1 (25.4)	2¾ (70)	5	25
CRZP4872	Zinc plated	Steel	48 – 72 (1220 – 1830)				
CRZP7296	Zinc plated	Steel	72 – 96 (1830 – 2440)	1 (25.4)	2¾ (70)	5	20
CRZP96120	Zinc plated	Steel	96 – 120 (2440 – 3050)				

IN (MM)

ADJUSTABLE CLOSET ROD – FIXED END BRACKETS

CRF

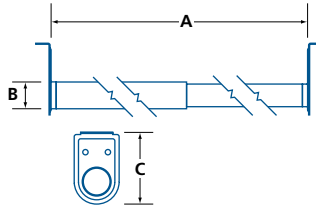

- Adjustable closet rod with fixed end-brackets
- 1" (25.4mm) diameter rod
- Mounting hardware included: wood screws and center support bracket
- Sizes 1830 and 3048 do not include the center support bracket
- Maximum capacity: 40 lbs/12" (18 kg/30 cm)

MODEL	FINISH	SIZE	MATERIAL	A	B	C	/BOX	/CASE
CRF	ZP	1830	Steel	18 – 30 (460 – 760)				
CRF	ZP, W	3048	Steel	30 – 48 (760 – 1220)	1 (25.4)	2⅝ (67)	6	30
CRF	ZP, W	4872	Steel	48 – 72 (1220 – 1830)				
CRF	ZP, W	7296	Steel	72 – 96 (1830 – 2440)				
CRF	ZP, W	96120	Steel	96 – 120 (2440 – 3050)	1 (25.4)	2⅝ (67)	6	18
CRF	ZP, W	96150	Steel	96 – 150 (2440 – 3810)				

IN (MM)

CLOSET HARDWARE

GENERAL HARDWARE

CLOSET SHELF SUPPORTS – WITH CLOSET ROD HOOK

CRSBW-H2



CRSBW-H2

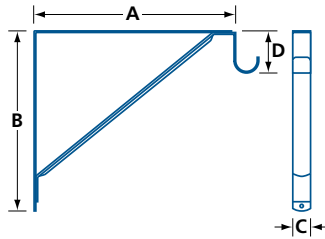

- Can accommodate closet rods up to 1" (25.4 mm) diameter
- Mounting hardware included: wood screws
- Maximum weight capacity : 160 kg (350 lbs)

MODEL	FINISH	MATERIAL	A	B	C	D	/BOX
CRSBW-H2	White	Steel	10½ (267)	10¼ (260)	1 (25.4)	2½ (63.5)	20

IN (MM)

CLOSET SHELF SUPPORTS

CRSBW-2



CRSBW-2

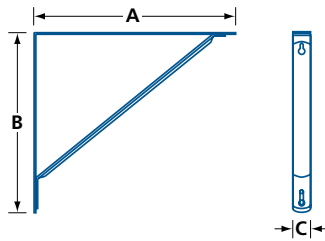

- Mounting hardware included: wood screws
- Maximum weight capacity: 160 kg (350 lbs)

MODEL	FINISH	MATERIAL	A	B	C	D	/BOX
CRSBW-2	White	Steel	10½ (267)	10¼ (260)	1 (25.4)	—	20

IN (MM)



WARDROBE HOOKS

GENERAL HARDWARE

WARDROBE HOOKS – CONTEMPORARY

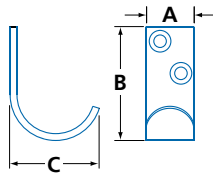

- Stainless steel coat hook
- Mounting hardware included: wood screws, plastic anchors

MODEL	FINISH	MATERIAL	A	B	C
5805	32D	Stainless steel	1 ³ / ₁₆ (20)	2 (51)	1 ⁹ / ₁₆ (40)

IN (MM)

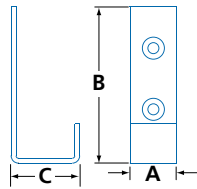

- Stainless steel coat hook
- Mounting hardware included: wood screws, plastic anchors

MODEL	FINISH	MATERIAL	A	B	C
5806	32D	Stainless steel	1 ³ / ₁₆ (20)	2 ⁹ / ₁₆ (65)	1 ¹ / ₄ (31)

IN (MM)

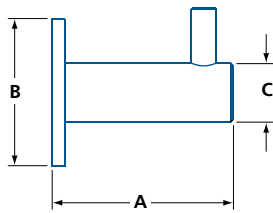

- Stainless steel coat hook
- Concealed mounting
- Mounting hardware included: wood screws, plastic anchors

MODEL	FINISH	MATERIAL	∅ A	B	∅ C
5807	32D	Stainless steel	1 ³ / ₈ (35)	1 ¹¹ / ₁₆ (42)	⁹ / ₁₆ (14)

IN (MM)

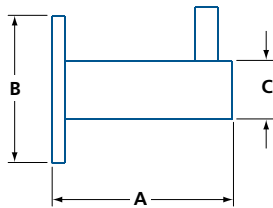
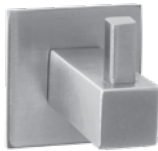

- Stainless steel coat hook
- Concealed mounting
- Mounting hardware included: wood screws, plastic anchors

MODEL	FINISH	MATERIAL	∅ A	B	∅ C
5808	32D	Stainless steel	1 ³ / ₈ (35)	1 ¹¹ / ₁₆ (42)	⁹ / ₁₆ (14)

IN (MM)

WARDROBE HOOKS

GENERAL HARDWARE

WARDROBE HOOKS – TRADITIONAL

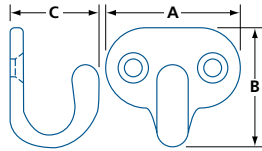

- Solid brass coat hook
- Mounting hardware included: wood screws

MODEL	FINISH	MATERIAL	A	B	C	/BOX
0580	BP	Brass	1 ³ / ₁₆ (30.2)	1 (25.4)	³ / ₄ (19.1)	10

IN (MM)

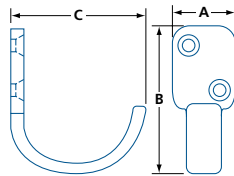

- Solid brass coat hook
- Mounting hardware included: wood screws

MODEL	FINISH	MATERIAL	A	B	C	/BOX
0595	BP	Brass	1 ¹ / ₁₆ (17.5)	1 ¹ / ₁₆ (42.8)	1 ⁹ / ₁₆ (39.7)	50

IN (MM)

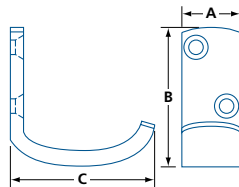

- Solid brass coat hook
- Mounting hardware included: wood screws

MODEL	FINISH	MATERIAL	A	B	C	/BOX
5803	BP	Brass	1 ¹ / ₁₆ (17.5)	1 ¹ / ₄ (31.8)	1 ³ / ₈ (42)	25

IN (MM)

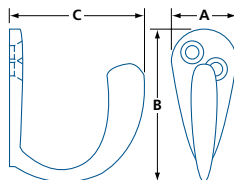

- Zinc die-cast coat hook
- Mounting hardware included: wood screws

MODEL	FINISH	MATERIAL	A	B	C	/BOX
3542	BP, CHR	Zinc die-cast	1 ¹ / ₁₆ (17.5)	1 ¹ / ₂ (38.1)	1 ¹ / ₂ (38.1)	100

IN (MM)

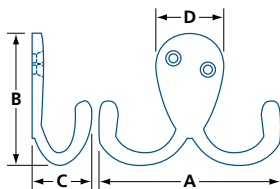

- Zinc die-cast double coat hook
- Mounting hardware included: wood screws

MODEL	FINISH	MATERIAL	A	B	C	D	/BOX
3541	BP, CHR	Zinc die-cast	2 ¹³ / ₁₆ (71.4)	1 ⁷ / ₈ (47.6)	1 ¹ / ₁₆ (27)	1 ¹⁵ / ₁₆ (23.8)	50

IN (MM)



WARDROBE HOOKS

GENERAL HARDWARE

WARDROBE HOOKS – HAT & COAT

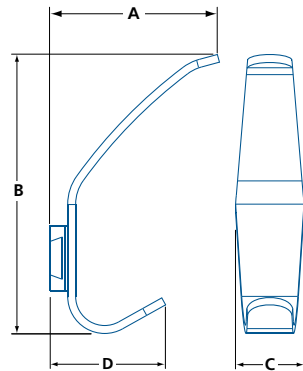

- Contemporary stainless steel hook
- Concealed mounting
- Mounting hardware included: wood screws, plastic anchors and hex key

MODEL	FINISH	MATERIAL	A	B	C	D	/BOX
5804	32D	Stainless steel	17/16 (37)	515/16 (151)	39/16 (90)	21/2 (64)	4

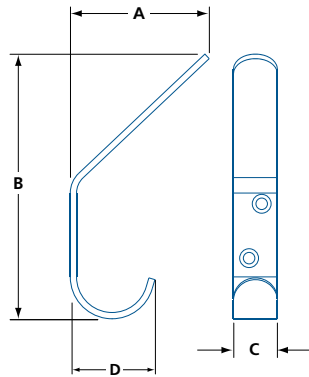

- Contemporary stainless steel hook
- Mounting hardware included: wood screws, plastic anchors

MODEL	FINISH	MATERIAL	A	B	C	D	/BOX
5802	32D	Stainless steel	3/4 (19)	51/2 (140)	25/16 (58)	13/4 (44)	10

IN (MM)

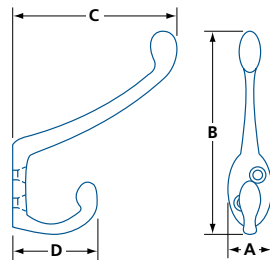

- Traditional coat & hat hook
- Mounting hardware included: wood screws

MODEL	FINISH	MATERIAL	A	B	C	D	/BOX
3543	BP, CHR, C26D	Zinc Diecast	13/16 (20.6)	31/2 (89)	2 (50.8)	49/16 (40)	10
3545	BP, CHR	Zinc Diecast	1 (25.4)	47/8 (118)	31/2 (89)	2 (50.8)	10

IN (MM)

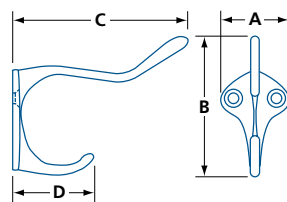

- Traditional coat & hat hook
- Mounting hardware included: wood screws

MODEL	FINISH	MATERIAL	A	B	C	D	/BOX
6206	BP, CHR	Zinc Diecast	11/8 (28.6)	21/4 (57)	23/4 (70)	13/8 (34)	10

IN (MM)

HANDRAIL BRACKETS

GENERAL HARDWARE

HANDRAIL BRACKETS

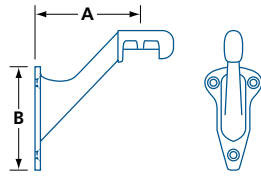

- **#3590L** Backset with large projection is the best choice for new building code compliance
- Mounting hardware included: wood screws, mounting bracket



MODEL	FINISH	MATERIAL	A	B	/BOX
3590L	C3, C11P, C15, C15A, C19	Zinc die-cast	3¼ (83)	2¼ (57)	50
3590	C15	Zinc die-cast	2¾ (59)	2¼ (57)	25

IN (MM)

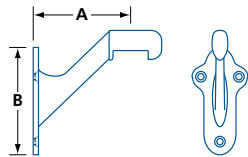

- Heavy-duty
- Mounting hardware included: wood screws, mounting bracket



MODEL	FINISH	MATERIAL	A	B	/BOX
695	C3, C15, NP	Zinc die-cast	2⅞ (67)	2⅛ (75)	50

IN (MM)

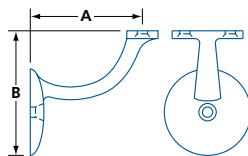

- Mounting hardware included: wood screws

MODE	FINISH	MATERIAL	A	B	/BOX
8424	C3, C5, C11P, C15A, C26D	Zinc die-cast	2¾ (70)	3⅞ (79)	10

IN (MM)



DOOR CATCHES & LATCHES

GENERAL HARDWARE

ROLLER CATCH

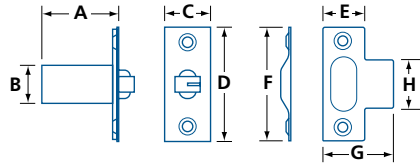

- For wood door and frame
- Nylon roller
- Adjustable for door gap
- Mounting hardware included: wood screws
- Includes T-Strike

MODEL	FINISH	MATERIAL	A	∅B	C	D	E	F	G	H	/BOX
01012	C26D	Zinc die-cast	1½ (38.8)	¾ (19.1)	29/32 (23)	2¼ (58)	13/16 (21)	2¼ (58)	19/16 (36)	11/16 (27.3)	25

IN (MM)

HEAVY DUTY ROLLER CATCH

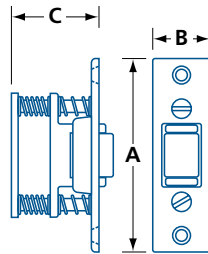

- Adjustment for door gap
- Adjustable spring tension on roller
- Mounting hardware included: wood screws

- #01015 No strike included
- #01015D Includes full lip D-strike
- #01015T Includes T-strike
- #01015ASA Includes ASA-strike

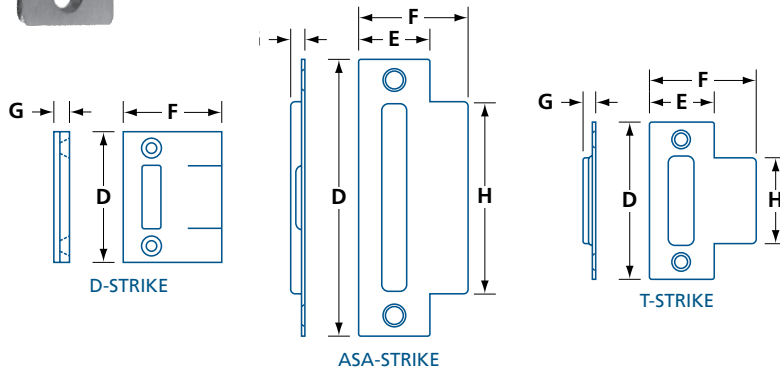

MODEL	FINISH	MATERIAL	A	B	C	D	E	F	G	H	/BOX
01015	C26D	Zinc die-cast	39/8 (86)	1 (25.4)	19/16 (39.6)	—	—	—	—	—	10
01015D	C3, C26D	Zinc die-cast	39/8 (86)	1 (25.4)	19/16 (39.6)	29/32 (58)	—	13/4 (44.5)	3/16 (4.8)	—	10
01015T	C26D	Zinc die-cast	39/8 (86)	1 (25.4)	19/16 (39.6)	23/4 (70)	13/32 (29.4)	17/8 (47.6)	1/16 (1.5)	1½ (38.8)	10
01015ASA	C26D	Zinc die-cast	39/8 (86)	1 (25.4)	19/16 (39.6)	47/8 (124)	1¼ (38.1)	115/16 (49.2)	3/32 (2.4)	39/8 (86)	—

IN (MM)

DOOR CATCHES & LATCHES

GENERAL HARDWARE

BALL CATCH

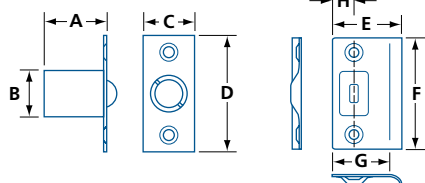

- For wood door and frame
- Strike included for 1 3/8" (35 mm) thick door
- Mounting hardware included: wood screws

MODEL	FINISH	MATERIAL	A	ø B	C	D	E	F	G	H	/BOX
01013	C3, C5, C15A, C26, C26D	Steel	1 3/16 (30.1)	27/32 (21.5)	1 (25.4)	2 1/4 (57)	1 7/16 (36.5)	2 1/8 (54)	1 3/16 (30)	1/2 (12.7)	50

IN (MM)

BALL CATCH – ADJUSTABLE

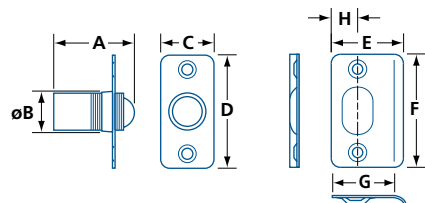
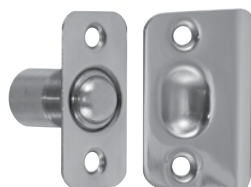

- For wood door and frame
- Adjustable spring tension
- Adjustable for frame gap to 3/16" (5 mm)
- Strike for 1 3/8" (35 mm) doors; 3/16" (5 mm) rounded corners
- Mounting hardware included: wood screws
- Brass body and faceplate
- Steel ball and strike

MODEL	FINISH	MATERIAL	A	ø B	C	D	E	F	G	H	/BOX
01014	C3, C10B, C15, C15A, C19, C26D	Brass	1 1/16 to 1 1/4 (27 to 31.8)	25/32 (19,8)	1 (25.4)	2 1/8 (54)	1 3/8 (35,4)	2 1/8 (54)	1 3/16 (30)	1/2 (12.7)	20

IN (MM)

BALL CATCH – DRIVE IN

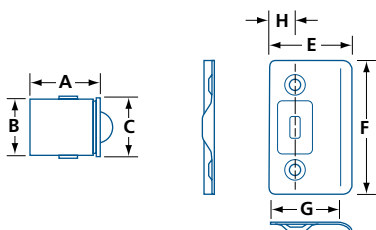

- For wood door and frame
- Zinc die-cast body, with steel ball and strike
- Fits into 1" (25.4 mm) bore
- Strike for 1 3/8" (35 mm) doors; 7/32" (5 mm) rounded corners
- Mounting hardware included: wood screws

MODEL	FINISH	MATERIAL	A	ø B	ø C	E	F	G	H	/BOX
01003	C10B, C11P, C15, C19, C26, C26D	Zinc die-cast	1 3/16 (30.1)	15/16 (23.8)	1 (25.4)	1 3/8 (34.9)	2 1/4 (57)	1 3/16 (30)	1/2 (12.7)	50

IN (MM)



LAVATORY PARTITION

GENERAL HARDWARE



LAVATORY HARDWARE



Lavatory Clamp Flange Spring Hinge.

Single action with adjustable spring tension. For doors and jambs $\frac{7}{8}$ - $1\frac{1}{4}$ " (22-32 mm) thick.

1001

3½x4" (89x102 mm)

01001

3½x2" (89x51 mm)

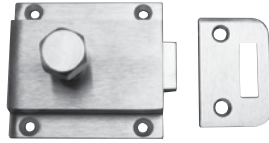

5019

Rim bolt & keeper.

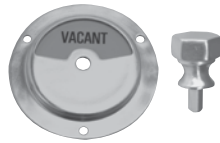

5017

Occupancy indicator & emergency key. Pairs with #5019 rim bolt.

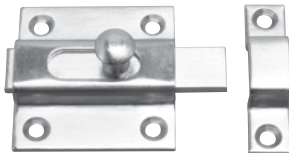

5004

Rim Bolt & Keeper.

- BOMMER offers a wide variety of lavatory hardware items including partition supports, door hinges, spring hinges, door stops and locks
- All made in solid brass and available in a variety of finishes

Please contact to order or visit www.bommer.com for details.

BATH HARDWARE

GENERAL HARDWARE

DOREX BATH HARDWARE – RIDGE

BH-RG

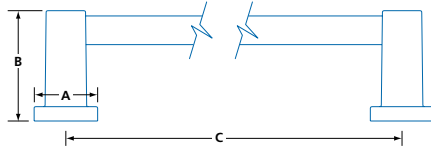

TOWEL BAR

- Zinc posts with stainless steel bar
- Includes mounting hardware

MODEL	LENGTH	FINISH	A	B	C*
BH-RG	18	26, 19	1 $\frac{5}{8}$ (42)	2 $\frac{7}{8}$ (73)	18 (457.2)
	24				24 (609.6)

IN (MM) (*) CENTER TO CENTER LENGTH

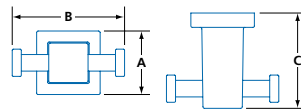

DOUBLE ROBE HOOK

- Zinc posts with brass robe hooks
- Includes mounting hardware

MODEL	FINISH	A	B	C
BH-RG53	26, 19	1 $\frac{5}{8}$ (42)	2 $\frac{15}{16}$ (74.3)	2 $\frac{1}{2}$ (63)

IN (MM)

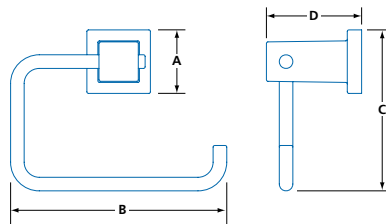

PAPER HOLDER

- Zinc post with steel paper holder
- Includes mounting hardware

MODEL	FINISH	A	B	C	D
BH-RG55	26, 19	1 $\frac{5}{8}$ (42)	5 $\frac{5}{8}$ (143)	4 $\frac{3}{16}$ (106.5)	2 $\frac{1}{2}$ (63)

IN (MM)

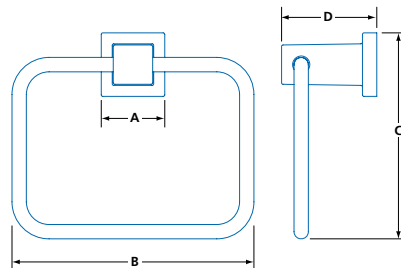

TOWEL RING

- Zinc post with stainless steel ring
- Includes mounting hardware

MODEL	FINISH	A	B	C	D
BH-RG60	26, 19	1 $\frac{5}{8}$ (42)	6 $\frac{5}{16}$ (160)	5 $\frac{3}{8}$ (136.3)	2 $\frac{1}{2}$ (63)

IN (MM)

BATH HARDWARE

GENERAL HARDWARE

DOREX BATH HARDWARE – CONTOUR

BH-CN

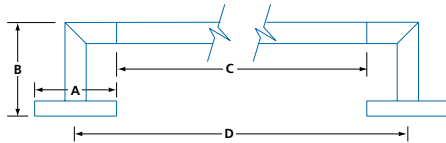

TOWEL BAR

- Zinc post with stainless steel bar
- Includes mounting hardware

MODEL	LENGTH	FINISH	A	B	C	D*
BH-CN	18	26, 19	2 3/8 (60.0)	2 3/4 (70.8)	18 (457.2)	20 3/16 (513.2)
	24				24 (609.6)	26 3/16 (665.6)

IN (MM) (*) CENTER TO CENTER LENGTH



BH-CN53-26

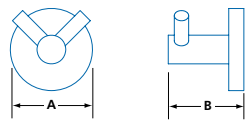

BH-CN54-26

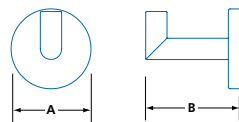

ROBE HOOKS

- #BH-CN53 (Double Hook): Zinc post with steel robe hooks
- #BH-CN54 (Single Hook): Zinc post and robe hooks
- Includes mounting hardware

MODEL	FINISH	A	B
BH-CN53	26, 19	2 3/8 (60.0)	2 1/8 (53.7)
BH-CN54			2 3/4 (70.8)

IN (MM)



BH-CN55-26

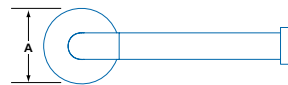
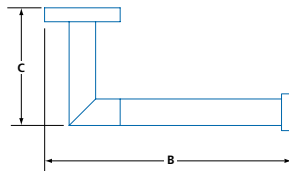

PAPER HOLDER

- Zinc post with stainless steel tube
- Includes mounting hardware

MODEL	FINISH	A	B	C
BH-CN55	26, 19	2 3/8 (60.0)	6 7/8 (175.0)	2 15/16 (74.8)

IN (MM)



BH-CN60-26

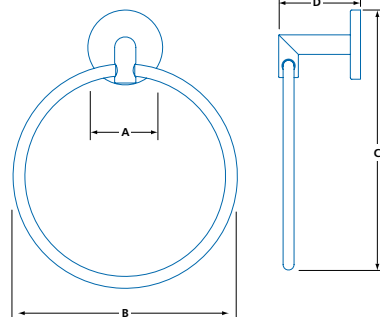

TOWEL RING

- Zinc post with stainless steel ring
- Includes mounting hardware

MODEL	FINISH	A	B	C	D
BH-CN60	26, 19	2 3/8 (60.0)	7 3/32 (180.0)	8 7/8 (225.3)	2 3/4 (70.8)

IN (MM)



BATH HARDWARE

GENERAL HARDWARE

DOREX BATH HARDWARE – VECTOR

BH-VC



BH-VC18-26 / BBH-VC24-26

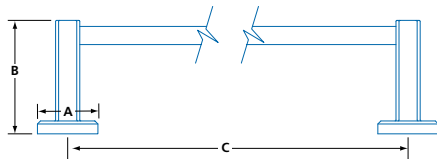

TOWEL BAR

- Zinc posts with stainless steel bar
- Includes mounting hardware

MODEL	LENGTH	FINISH	A	B	C*
BH-VC	18	15, 19, 26	1 $\frac{9}{16}$ (40)	3 (75)	17 $\frac{3}{4}$ (451.2)
	24				23 $\frac{3}{4}$ (603.6)

IN (MM) (*) CENTER TO CENTER LENGTH



BH-VC54-26

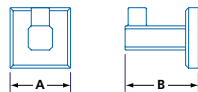

SINGLE ROBE HOOK

- Zinc post and robe hook
- Includes mounting hardware

MODEL	FINISH	A	B
BH-VC54	15, 19, 26	1 $\frac{9}{16}$ (40)	1 $\frac{7}{8}$ (48.5)

IN (MM)



BH-VC55-26

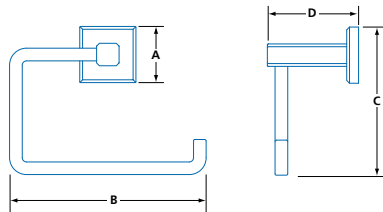

PAPER HOLDER

- Zinc post and paper holder
- Includes mounting hardware

MODEL	FINISH	A	B	C	D
BH-VC55	15, 19, 26	1 $\frac{9}{16}$ (40)	5 $\frac{1}{2}$ (140)	4 $\frac{7}{32}$ (105.5)	2 $\frac{9}{16}$ (65)

IN (MM)



BH-VC60-26

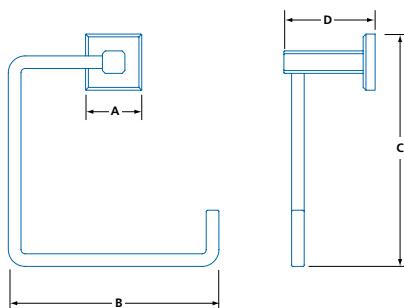

TOWEL RING

- Zinc post and ring
- Includes mounting hardware

MODEL	FINISH	A	B	C	D
BH-VC60	15, 19, 26	1 $\frac{9}{16}$ (40)	5 $\frac{15}{16}$ (150)	6 $\frac{1}{2}$ (165.5)	2 $\frac{9}{16}$ (65)

IN (MM)

BATH HARDWARE

GENERAL HARDWARE

DOREX BATH HARDWARE KIT – VECTOR

BH-VCK



4 PIECE BATH SET

- Complete bath set for any bathroom
- Includes mounting hardware

BH-VCK24 - 26

MODEL FINISH

15

SATIN NICKEL

19

MATTE BLACK

26

POLISHED
CHROME

INCLUDES

- » 24in Towel Bar (#BH-VC24)
- » Single Robe Hook (#BH-VC54)
- » Paper Holder (#BH-VC55)
- » Towel Ring (#BH-VC60)

See page 06.612 for details



BATH HARDWARE

GENERAL HARDWARE

DOREX BATH HARDWARE – HORIZON

BH-HR



BH-HR18-26 / BH-HR24-26

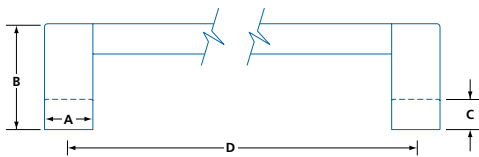

TOWEL BAR

- Zinc posts with stainless steel bar
- Includes mounting hardware

MODEL	LENGTH	FINISH	A	B	C	D*
BH-HR	18	26, 19	1 ⁹ / ₁₆ (40)	2 ³ / ₄ (70)	5/ ₈ (16)	18 (489.2)
	24					24 (641.6)

IN (MM) (*) CENTER TO CENTER LENGTH



BH-HR53-26

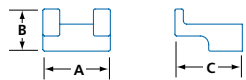

BH-HR54-26

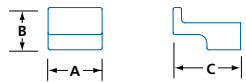

ROBE HOOKS

- Solid zinc robe hooks
- Double hook (#BH-HR53) and single hook (#BH-HR54) models
- Includes mounting hardware

MODEL	FINISH	A	B	C
BH-HR53	26, 19	1 ⁹ / ₁₆ (40)	1 (25)	1 ⁹ / ₁₆ (40)
BH-HR54		1 ⁵ / ₈ (32)		

IN (MM)



BH-HR55-26

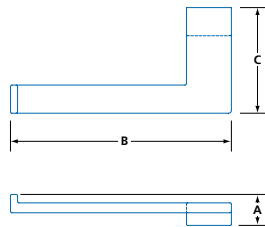

PAPER HOLDER

- Solid zinc paper holder
- Includes mounting hardware

MODEL	FINISH	A	B	C
BH-HR55	26, 19	7/ ₈ (22)	6 ³ / ₁₆ (157)	3 (75)

IN (MM)



BH-HR60-26

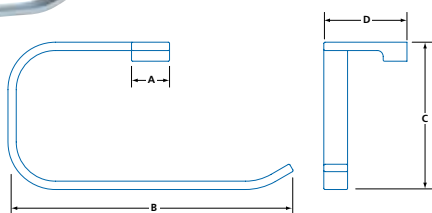

TOWEL RING

- Solid zinc ring
- Includes mounting hardware

MODEL	FINISH	A	B	C	D
BH-HR60	26, 19	1 ⁹ / ₁₆ (40)	6 ⁵ / ₁₆ (240)	5 ³ / ₈ (124)	2 ³ / ₄ (70)

IN (MM)

BATH HARDWARE

GENERAL HARDWARE

DOREX BATH HARDWARE – ELEMENT

BH-ET



BH-ET18-26 / BH-ET24-26

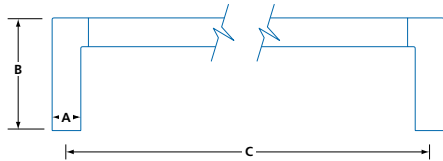

TOWEL BAR

- Zinc posts with stainless steel bar
- Includes mounting hardware

MODEL	LENGTH	FINISH	A	B	C*
BH-ET	18	26, 19	$\frac{3}{4}$ (19)	3 (74.5)	$19\frac{1}{8}$ (486.2)
	24				$25\frac{1}{8}$ (638.6)

IN (MM) (*) CENTER TO CENTER LENGTH



BH-ET54-26

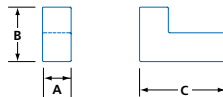

ROBE HOOK

- Zinc robe hooks
- Includes mounting hardware

MODEL	FINISH	A	B	C
BH-ET54	26, 19	$\frac{3}{4}$ (19)	$1\frac{1}{16}$ (36)	$2\frac{1}{4}$ (57)

IN (MM)



BH-ET55A-26



BH-ET97-26

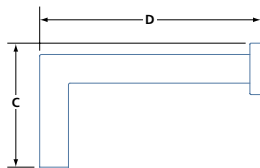

PAPER HOLDERS

- Zinc paper holders
- Horizontal mounted (#BH-E55A)
- Vertical mounted (#BH-E97) for spare paper roll
- Includes mounting hardware

MODEL	FINISH	TYPE	A	B	C	D
BH-ET55A	26, 19	Horizontal	$\frac{3}{4}$ (19)	$1\frac{3}{8}$ (34)	$4\frac{3}{16}$ (106.5)	$5\frac{5}{8}$ (143)
BH-ET97		Vertical				

IN (MM)



BH-ET60-26

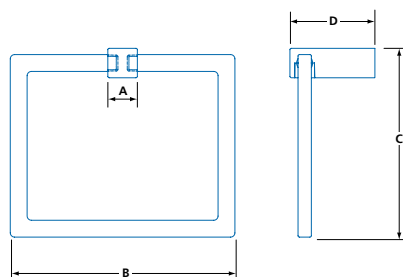

TOWEL RING

- Zinc post with zinc ring
- Includes mounting hardware

MODEL	FINISH	A	B	C	D
BH-ET60	26, 19	$\frac{3}{4}$ (19)	$6\frac{5}{16}$ (160)	$5\frac{1}{4}$ (134.5)	$2\frac{3}{8}$ (60.5)

IN (MM)

MAGNETIC CATCHES

GENERAL HARDWARE

MAGNETIC CATCH

M700

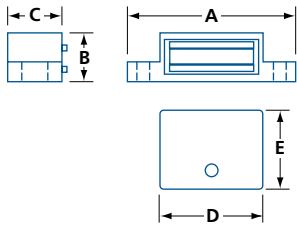
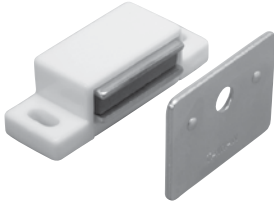

- Zinc plated steel strike
- Plastic housing with magnet
- Magnet holding capacity is 2 lbs (0.9 kg)

MODEL	FINISH	A	B	C	D	E	/BOX
M700	B, W, WA	1 ³ / ₄ (44.5)	1/2 (12.7)	9/16 (14.3)	1 ³ / ₁₆ (30.5)	29/32 (23)	100

IN (MM)

MAGNETIC CATCH – HIGH STRENGTH

M1800-1

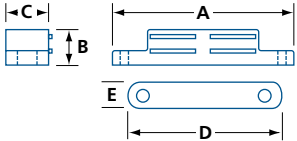

- Zinc plated steel strike
- Plastic housing with magnet
- Magnet holding capacity is 18 lbs (8 kg)

MODEL	FINISH	A	B	C	D	E	/BOX
M1800-1	White	27/8 (73)	9/16 (14.3)	11/16 (17.5)	23/8 (60)	1/2 (12.7)	20

IN (MM)

MAGNETIC CATCH – TALL

M2800

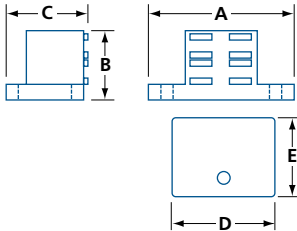

- Zinc plated steel strike
- Plastic housing with magnet
- Magnet holding capacity is 6 lbs (2.7 kg)
- Includes mounting screws

MODEL	FINISH	A	B	C	D	E	/BOX
M2800W	White	1 ²⁵ / ₃₂ (45)	7/8 (22.2)	15/16 (24)	17/32 (31)	29/32 (23)	50

IN (MM)

BALL & ROLLER CATCHES

GENERAL HARDWARE

BALL & ROLLER CATCHES

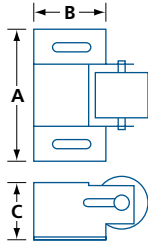
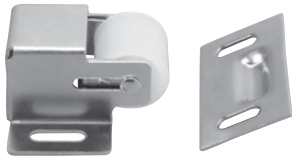

JUMBO ROLLER CATCH

- Spring loaded plastic roller
- Mounting hardware included: wood screws

MODEL	FINISH	MATERIAL	A	B	C	/BOX
2804	Zinc plated	Steel	1 ¹⁵ / ₁₆ (49.4)	1 (25.4)	1 ⁵ / ₁₆ (23.8)	50

IN (MM)

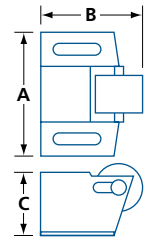

SINGLE ROLLER CATCH

- Spring loaded plastic roller
- Mounting hardware included: wood screws

MODEL	FINISH	MATERIAL	A	B	C	/BOX
950	Zinc plated	Steel	1 ³ / ₈ (34.9)	3/4 (19.1)	1 ¹ / ₁₆ (17.5)	100

IN (MM)

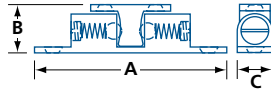
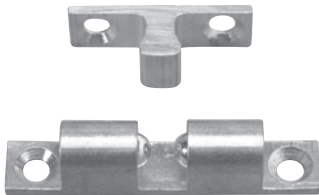

BRASS BALL CATCH

- Spring loaded steel balls
- Adjustable spring tension

MODEL	FINISH	MATERIAL	A	B	C	/BOX
112	Polished brass	Brass	1 ¹⁵ / ₁₆ (49.4)	1/2 (12.7)	3/8 (9.5)	40

IN (MM)

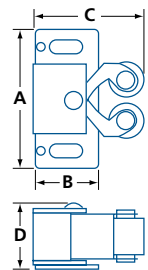
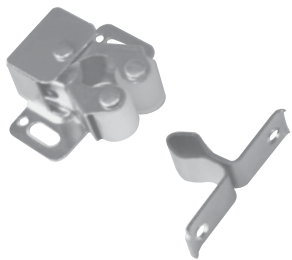

DOUBLE ROLLER CATCH

- Spring loaded plastic rollers
- Mounting hardware included: wood screws

MODEL	FINISH	MATERIAL	A	B	C	D	/BOX
3631ZP	Zinc plated	Steel	1 ¹ / ₄ (31.8)	9/16 (14.3)	1 ¹ / ₈ (28.6)	5/8 (15.9)	100

IN (MM)

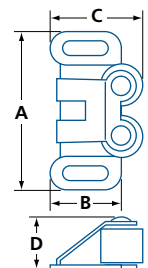

DOUBLE ROLLER CATCH WITH CLIP

- Plastic rollers
- Spring c-clip
- Mounting hardware included: wood screws

MODEL	FINISH	MATERIAL	A	B	C	D	/BOX
3632ZP	Zinc plated	Steel	1 ¹¹ / ₁₆ (42.9)	3/4 (19.1)	1 ⁵ / ₁₆ (23.8)	1/2 (12.7)	100

IN (MM)



REINFORCEMENT HARDWARE

GENERAL HARDWARE

REINFORCEMENT BRACES

366 SERIES

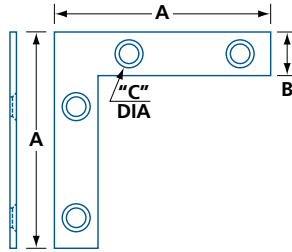
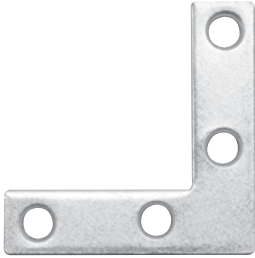

MODEL	FINISH	MATERIAL	A	B	øC	/BOX
36611-15	Zinc Plated	Steel	1½ (38.1)	¾ (9.5)	⅜ (4.8)	20
36611-2	Zinc Plated	Steel	2 (50.8)	¾ (9.5)	⅜ (4.8)	20

IN (MM)

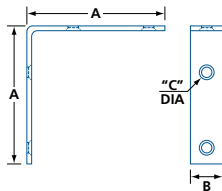

MODEL	FINISH	MATERIAL	A	B	øC	/BOX
36615-1	Zinc Plated	Steel	1 (25.4)	½ (12.7)	⅞ (5.6)	20
36615-15	Zinc Plated	Steel	1½ (38.1)	½ (12.7)	⅞ (5.6)	20
36615-2	Zinc Plated	Steel	2 (50.8)	⅝ (15.9)	⅞ (5.6)	20
36615-25	Zinc Plated	Steel	2½ (64)	⅝ (15.9)	⅞ (5.6)	20
36615-3	Zinc Plated	Steel	3 (76)	¾ (19.1)	¼ (6.4)	20
36615-4	Zinc Plated	Steel	4 (102)	⅞ (22.2)	¼ (6.4)	10

IN (MM)

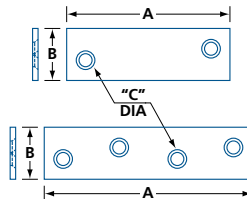

36618-2 / -25

36618-3 / -4

MODEL	FINISH	MATERIAL	A	B	øC	/BOX
36618-2	Zinc Plated	Steel	2 (50.8)	⅝ (15.9)	⅞ (5.6)	20
36618-25	Zinc Plated	Steel	2½ (38.1)	⅝ (15.9)	⅞ (5.6)	20
36618-3	Zinc Plated	Steel	3 (76)	¾ (19.1)	⅞ (5.6)	20
36618-4	Zinc Plated	Steel	4 (102)	⅞ (22.2)	⅞ (5.6)	20

IN (MM)

SLIDING HARDWARE

GENERAL HARDWARE

SLIDING DOOR HARDWARE

10-4060



- For pocket-door, wall-mounted, by-pass or multi-track applications
- For door panel 1 – 1 $\frac{3}{4}$ " (25.4 – 44.5 mm) thick when using fascia*
- Load capacity: 132 lbs (60 kg) per door panel
- Zinc die-cast hangers with ball bearing nylon wheels
- 2 hangers per door panel (one kit per door panel)
- Optional floor guides available, see 06.850

(*) Without fascia, maximum thickness is limited by installation and door weight.

For application options, please request an Application Guide.

MODEL	CAPACITY	TRACK*	FASCIA*
10-4060	(2) Ball bearing hangers (2) In-track stop/holders (1) Floor guide (1) Adjustment tool (10) Mounting screws (2) Plastic floor anchors	132 lbs (60 kg)	TR01, TR02B
			TRF01B**

(*) ALUMINUM TRACKS AND FASCIA SOLD SEPARATELY, VARIOUS LENGTHS AVAILABLE
(**) MAX. DOOR THICKNESS: 1 $\frac{3}{4}$ IN (44.5MM)

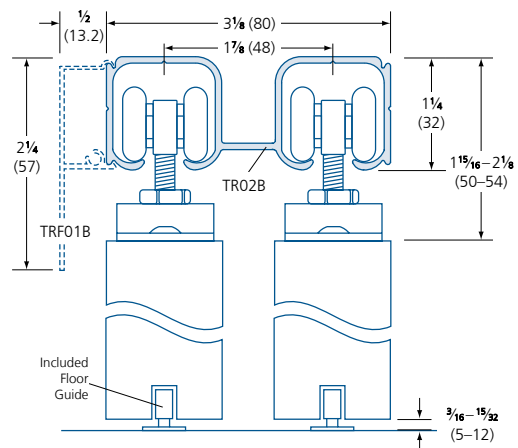
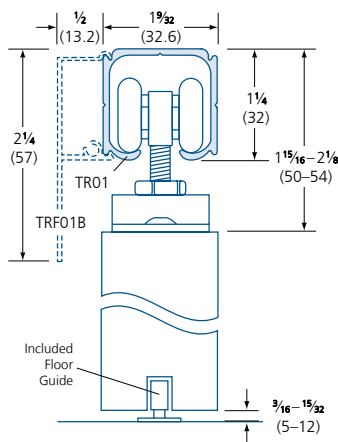

SLIDING HARDWARE

GENERAL HARDWARE

BY-PASS DOOR HARDWARE

20-4030-REV1



• **Updated model**

- For by-pass or multi-track applications including wardrobes, closets, room dividers and office partitions
- Maximum panel width: 1 3/4" (44.5 mm) using included floor guide, 1 3/8" (35 mm) thick using floor guide 21-1025-FG (not included)
- Load capacity: 66 lbs (30 kg) per door panel
- Aluminum side-mount hangers with ball bearing nylon wheels
- 2 hangers per door panel (one kit per pair of door panels)
- **NEW:** Vertical adjustment slot for ease of installation (up to 3/16")
- Alternative floor guides available as option, see 06.850

For application options, please request an Application Guide.

MODEL	CAPACITY	TRACK*	FASCIA*
20-4030-REV1	66 lbs (30 kg)	TR02B	TRF01B

(4) Ball bearing hangers
(4) In-track stoppers
(2) Floor guides
(20) Mounting screws
(4) Plastic anchors

(*) ALUMINUM TRACKS AND FASCIA SOLD SEPARATELY, VARIOUS LENGTHS AVAILABLE

Option with Floor Guide included in kit 20-4030-REV1

Requires Door Preparation

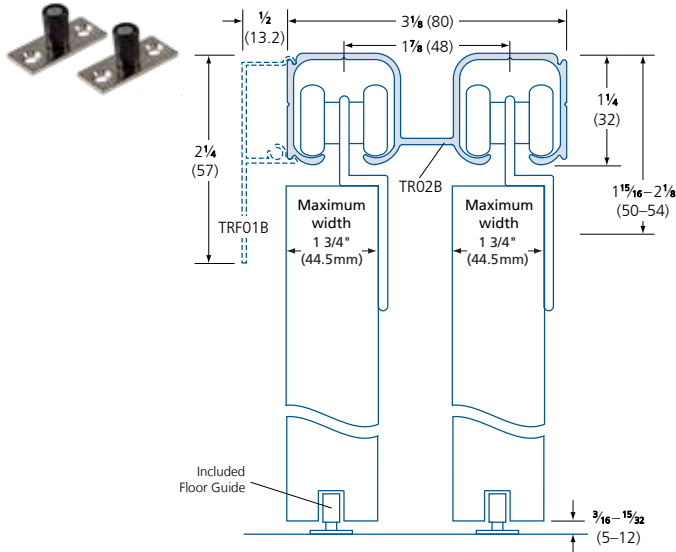

Option with Floor Guide 21-1025-FG not included with kit 20-4030-REV1. See page 06.850

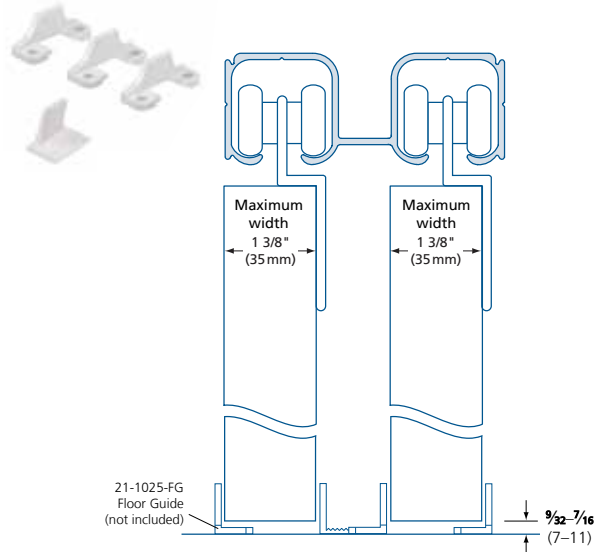

SLIDING HARDWARE

GENERAL HARDWARE

BY-PASS DOOR HARDWARE

21-1025

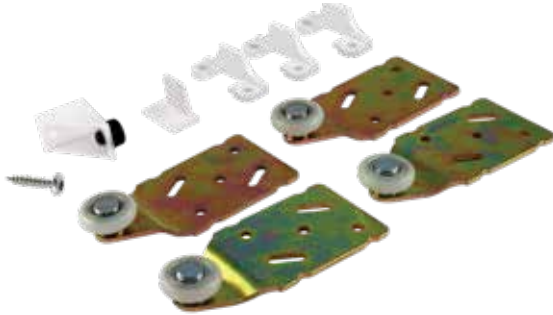

- For by-pass applications including wardrobes and closets
- For door panels up to 1 3/4" (44.5 mm) thick
- Load capacity: 55 lbs (25 kg) per door panel
- Steel side-mount hangers with ball bearing nylon wheels
- 2 hangers per door panel (one kit per two door panels)
- Optional floor guides available, see 06.850

For application options, please request an Application Guide.

MODEL		CAPACITY	TRACK*	FASCIA
21-1025	(4) Ball bearing hangers (1) Stop (1) 3-piece floor guide (24) Mounting screws	162 lbs (60 kg)	TR11	—

(*) ALUMINUM TRACK SOLD SEPARATELY, VARIOUS LENGTHS AVAILABLE

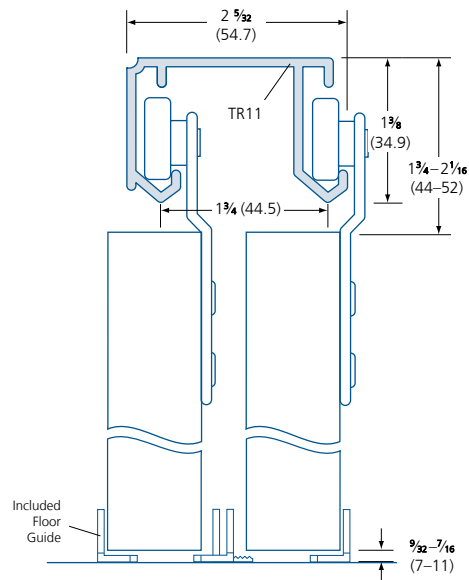

SLIDING HARDWARE

GENERAL HARDWARE

BI-FOLD DOOR HARDWARE

31-1015

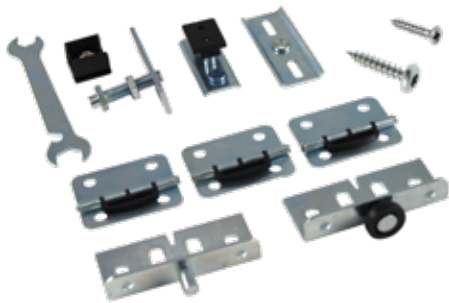

- Bi-fold door hardware for light-duty applications including closets, pantries and concealing utility and storage areas
- For door panels up to 1 $\frac{3}{8}$ " (35 mm)
- Load capacity: 33 lbs (15 kg) per bi-folding door
- Steel pivot assembly with ball bearing nylon wheel guide
- Steel panel hinges
- One kit per bi-folding door

For application options, please request an Application Guide.

MODEL	CAPACITY	TRACK*	FASCIA*
31-1015	(1) Top pivot assembly (1) Floor pivot (1) In-track stop/holder (1) Ball bearing guide (3) Panel hinges (1) Adjustment tool (20) Panel screws (5) Pivot screws	33 lbs (15 kg)	TR21 —

(* ALUMINUM TRACK SOLD SEPARATELY, VARIOUS LENGTHS AVAILABLE)

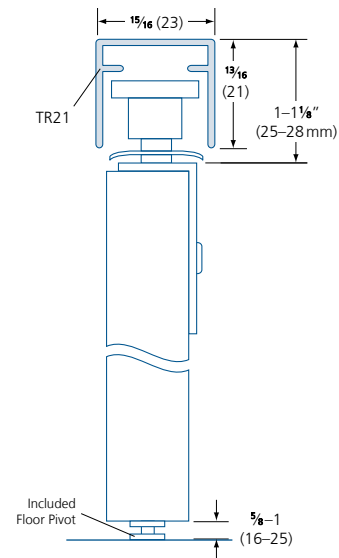

SLIDING HARDWARE

GENERAL HARDWARE

BI-FOLD DOOR HARDWARE

31-4060

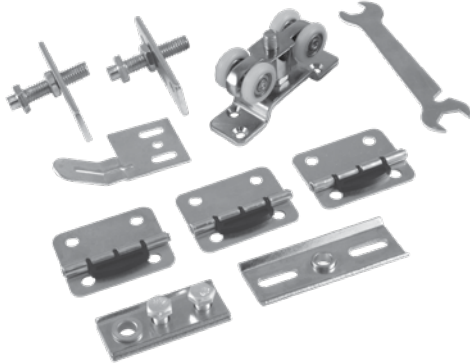

- For bi-fold door applications including wardrobes and closets
- For door panels $1\frac{3}{8}$ - $1\frac{3}{4}$ " (35 - 44.5 mm) thick
- Load capacity: 132 lbs (60 kg) per bi-fold door assembly
- Zinc die cast hangers with ball bearing nylon wheels
- 1 hanger per bi-fold door assembly

For application options, please request an Application Guide.

MODEL	CAPACITY	TRACK*	FASCIA
31-4060	132 lbs (60 kg)	TR01	—

(1) Ball bearing hanger
 (1) Top pivot assembly
 (1) Floor pivot assembly
 (1) Ball bearing guide
 (3) Panel hinges
 (1) Adjustment tool
 (20) Panel screws
 (5) Pivot screws

(*) ALUMINUM TRACK SOLD SEPARATELY, VARIOUS LENGTHS AVAILABLE

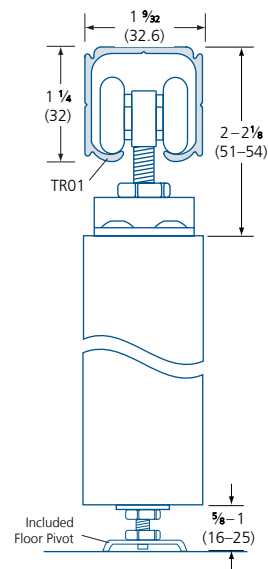

SLIDING HARDWARE

GENERAL HARDWARE

SLIDING TRACKS

TR01, TR02B, TR11, TR21

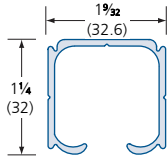

TR01 SINGLE TRACK

- Extruded aluminum track, mill finish
- Pre-drilled top mounting holes every 16" (406mm) to match wall mount (#WM01)
- Snap-on fascia (#TRF01B) available for one or both sides with matching end-caps (#TRFC01/TRFC01D) also available
- Wall mount bracket (#WM01) available
- Custom lengths available by special order
- Mounting hardware and screws are NOT included

STANDARD LENGTHS*

TR01-36	36" (914mm)
TR01-48	48" (1219mm)
TR01-60	60" (1524mm)
TR01-72	72" (1828mm)
TR01-84	84" (2133mm)
TR01-96	96" (2438mm)
TR01-108	108" (2743mm)
TR01-120	120" (3048mm)

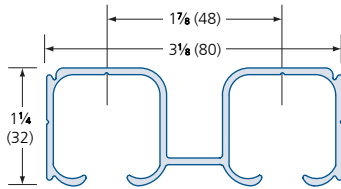

TR02B DOUBLE TRACK

- Extruded aluminum track, mill finish
- Pre-drilled top mounting holes every 12" (305mm)
- Snap-on fascia (#TRF01B) available for one or both sides
- Custom lengths available by special order
- Mounting hardware and screws are NOT included

STANDARD LENGTHS*

TR02B-48	48" (1219mm)
TR02B-60	60" (1524mm)
TR02B-72	72" (1828mm)
TR02B-84	84" (2133mm)
TR02B-96	96" (2438mm)
TR02B-108	108" (2743mm)
TR02B-120	120" (3048mm)

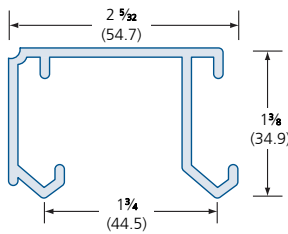

TR11 J-TRACK

- Extruded aluminum track, mill finish
- Pre-drilled top mounting holes every 12" (305mm)
- Custom lengths available by special order
- Mounting hardware and screws are NOT included

STANDARD LENGTHS*

TR11-36	36" (914mm)
TR11-48	48" (1219mm)
TR11-60	60" (1524mm)
TR11-72	72" (1828mm)

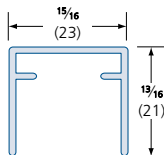

TR21 BI-FOLD TRACK

- Extruded aluminum track, mill finish
- Custom lengths available by special order
- Mounting hardware and screws are NOT included

STANDARD LENGTHS*

TR21-36	36" (914mm)
TR21-48	48" (1219mm)
TR21-60	60" (1524mm)
TR21-72	72" (1828mm)
TR21-84	84" (2133mm)
TR21-96	96" (2438mm)
TR21-120	120" (3048mm)
TR21-144	144" (3658mm)

(*) CUSTOM AND STANDARD LENGTHS CAN VARY BY ±1/8 IN (3 MM)

SLIDING HARDWARE

GENERAL HARDWARE

FASCIA

TRF01B

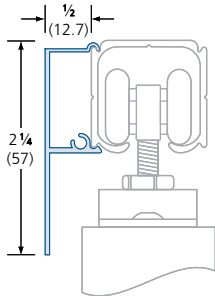

TRF01B SNAP-ON FASCIA

- Extruded aluminum track, clear anodized finish
- For use with #TR01 or #TR02B tracks only
- Improved design for easy installation and removal when track is ceiling mounted
- Custom lengths available by special order
- Mounting hardware and screws are NOT included

STANDARD LENGTHS*

TRF01B-48	48" (1219 mm)
TRF01B-60	60" (1524 mm)
TRF01B-72	72" (1828 mm)
TRF01B-84	84" (2133 mm)
TRF01B-96	96" (2438 mm)
TRF01B-108	108" (2743 mm)
TRF01B-120	120" (3048 mm)
TRF01B-144	144" (3658 mm)

(*) CUSTOM AND STANDARD LENGTHS CAN VARY BY ±1/8 IN (3 MM)



SLIDING HARDWARE

GENERAL HARDWARE

FASCIA END CAPS

TRFC01, TRFC01D

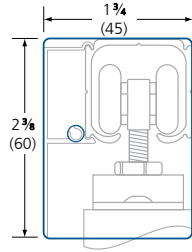

TRFC01S SINGLE END CAP

- Paired aluminum plates, clear anodized finish
- Fits single #TR01 track with #TRF01B fascia on either side
- Mounting screws included

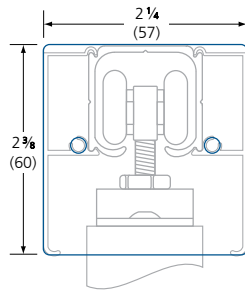

TRFC01D DOUBLE END CAP

- Paired aluminum plates, clear anodized finish
- Fits single #TR01 track with #TRF01B fascia on both sides
- Mounting screws included

FLOOR GUIDES

TRG01, TRG01A, 21-1025-FG

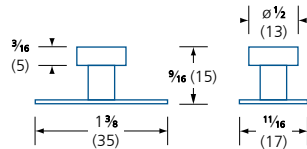
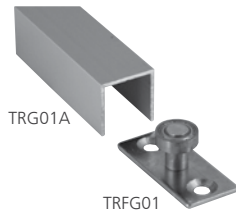

TRG01 FLOOR GUIDE

- Ball bearing floor guide
- Includes wood screws

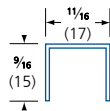

TRG01A FLOOR GUIDE TRACK

- Extruded aluminum track, milled finish
- Available in 72" (1828 mm) lengths
- Other cut lengths available by special order

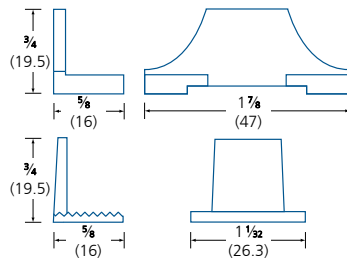

21-1025-FG FLOOR GUIDE

- Nylon floor guide for by-pass applications
- Included with #21-1025 kit
- Includes stop
- Includes wood screws

SLIDING HARDWARE

GENERAL HARDWARE

WALL MOUNT

WM01

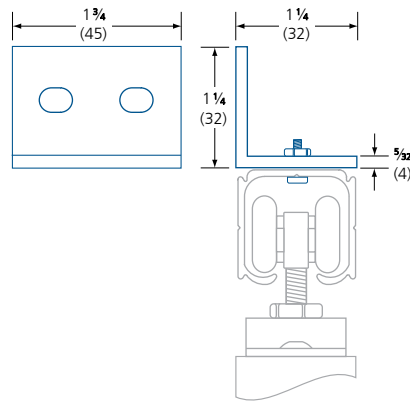

- Extruded aluminum bracket, clear anodized finish
- For use with #TR01 track
- (2) Plastic wall anchors and wood screws included
- (2) Machine screws and nut included
- Multiple mounts are required per track; one per 16" (406 mm) is recommended
- Wall spacers for extra clearance may be required for some installations (not provided; please verify your installation)



WINDOW CATCHES & LATCHES

GENERAL HARDWARE

TRANSOM CATCH

DC25

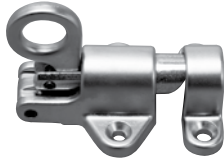

SUSAP49



SUSAP49FS



HR216

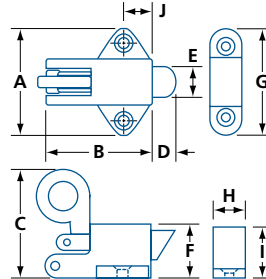

- Spring loaded latch
- Includes keeper
- Optional strikes sold separately
 - #SUSAP49 Flat strike
 - #SUSAP49FS Sash strike
 - #HR216 Replacement keeper

MODEL	FINISH	MATERIAL	A	B	C	D	E	F	G	H	I	J	/BOX
DC25	SL	Zinc die-cast	1 ¹³ / ₁₆ (46)	1 ³ / ₄ (44.5)	1 ³ / ₄ (44.5)	1 ¹³ / ₃₂ (10.3)	1/2 (12.7)	7/8 (22.2)	1 ³ / ₄ (44.5)	1/2 (12.7)	7/8 (22.2)	1/2 (12.7)	20

IN (MM)

TRANSOM CATCH

5215

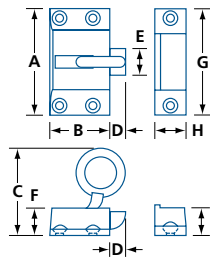
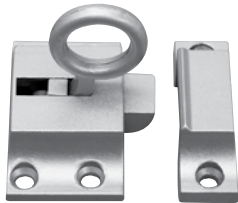

- Spring loaded latch
- Includes keeper
- Mounting hardware included: wood screws

MODEL	FINISH	MATERIAL	A	B	C	D	E	F	G	H	I	/BOX
5215	SL	Zinc die-cast	2 (50.8)	1 ¹ / ₈ (28.6)	1 ⁵ / ₈ (41.3)	5/16 (7.9)	1/2 (12.7)	1/2 (12.7)	2 (50.8)	1 ¹⁹ / ₃₂ (15.1)	1/2 (12.7)	20

IN (MM)

SASH HOOK

DC60



- Zinc die-cast hook
- Chrome plated
- Available with 3/4" (19 mm) diameter, 6 ft. or 12 ft. (1.83 m or 3.66 m) vinyl covered wood pole

MODEL	DESCRIPTION	/BOX
DC60	Hook only, no pole	30
DC60P	Hook with 6 ft. (1.83 m) vinyl covered pole	20
DC60P144	Hook with 12 ft. (3.66 m) vinyl covered pole	10

WINDOW CATCHES & LATCHES

GENERAL HARDWARE

CASEMENT WINDOW HANDLE

DC620T

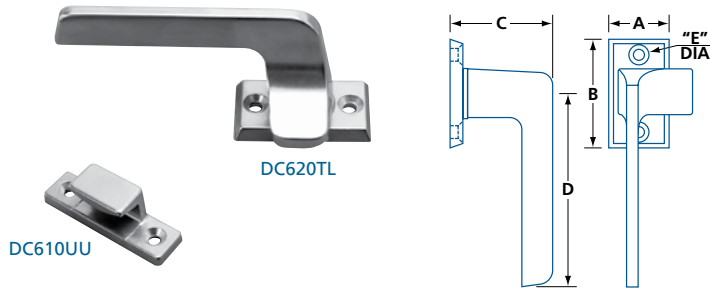

- Zinc die-cast lever
- Handed (left hand shown)
- 90° lever rotation
- Wedge keeper sold separately (#DC610)

MODEL	FINISH	MATERIAL	A	B	C	D	E	/BOX
DC620T	Satin chrome	Zinc die-cast	1 (25.4)	1¾ (44.5)	1⅝ (41.3)	3⅝ (79)	1⅞ (4.4)	20

IN (MM)

SASH LOCK

2832

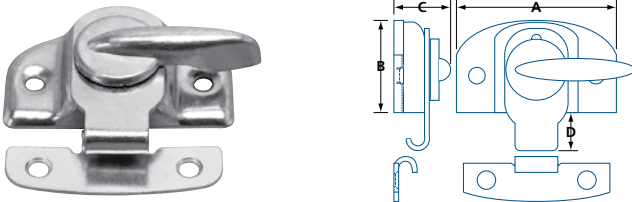

- Steel sash lock
- Spring loaded
- Mounting hardware included: wood screws

MODEL	FINISH	MATERIAL	A	B	C	D	/BOX
2832BP	Brass plated	Steel	2⅞ (60)	1⅝ (34.9)	1⅜ (20.6)	½ (12.7)	20

IN (MM)

WING BUTTON

5101, 5102



- Steel wing button locks
- Zinc plated
- Mounting hardware included: wood screws

MODEL	FINISH	MATERIAL	A	B	/BOX
5101	Zinc plated	Steel	1¾ (44.5)	¾ (19)	300
5102	Zinc plated	Steel	1¼ (31.8)	¾ (19)	300

IN (MM)



WINDOW HARDWARE

GENERAL HARDWARE

CREMONE BOLT SET

41371

- Cremone bolt set for French windows and doors
- High quality cast iron construction
- Set includes: 1 handle, 2 strikes, 1 center guide and 2 end-guides
- Rod sold separately; black finish (#62173EXB)

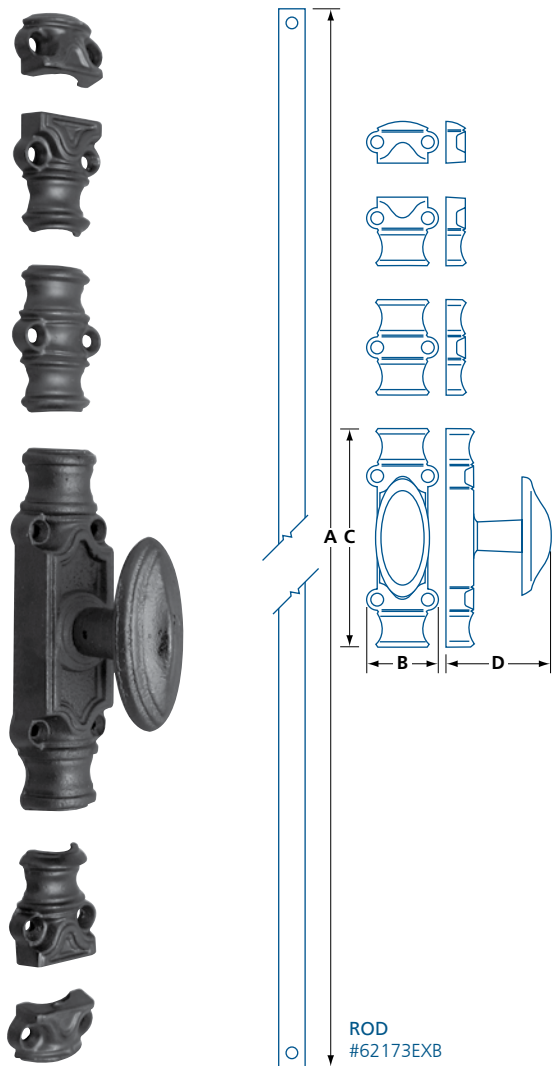

MODEL	FINISH	MATERIAL	A	B	C	D
41371EXB	Black	Cast-iron	51 $\frac{3}{16}$ (1300)	1 $\frac{1}{2}$ (38.1)	5 (127)	2 $\frac{3}{8}$ (60)

IN (MM)



Architectural Builders Hardware Mfg. Inc. (ABH) has been manufacturing the highest quality products for the past 20 years. Through the implementation of Robotics, Automation and Lean Manufacturing, ABH has been able to efficiently manufacture products at the highest quality standards.

www.abhmfg.com

ABH[®]

Choose from a variety of products



OVERHEAD
HOLDERS & STOPS



ELECTROMAGNETIC
DOOR HOLDERS



ALUMINUM
CONTINUOUS
GEARED HINGES



PIVOTS &
PIVOT SETS



RESCUE
HARDWARE



STAINLESS STEEL
PIN & BARREL
HINGES

HOSPITAL
PUSH / PULL
LATCHES

ELECTRICAL
POWER
TRANSFERS

OTHER PRODUCTS:



PIN & BARREL HINGES



EDGE GUARDS



ROLLER LATCHES

- Surface Bolts and Slide Bolts
- Custom strikes and pivots
- **And more**

FEATURES AND BENEFITS

- Anti-microbial coating available
- Most products are UL listed
- Most products are stainless steel
- Available in a variety of BHMA finishes
- Custom sizes and finishes available

Learn more at: www.abhmfg.com

Please contact your local Canaropa sales representative to order. Special orders may require additional delivery time and/or minimum order quantities.



Bommer Industries Builders Hardware Division continues the trademarks of quality and innovation that were founded in 1876. Bommer offers a complete line of Architectural Grade Butt Hinges, our industry leading line of Single Acting Spring Hinges, the world renowned Double Acting Spring Hinges, Specialty Door and Gate Pivots, and high quality Lavatory Hardware.

www.bommer.com



Single & Double Acting Spring Hinges



Single

- cULus listed
- BHMA certified Grade 1 (1 million cycles)
- Patented
- Available in many architectural finishes



Double

- Patented
- Available in many architectural finishes

BHMA Certified Architectural Hinges



5 knuckle,
bottom tip

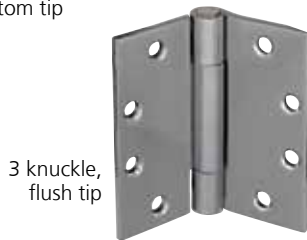

3 knuckle,
flush tip

- cULus listed
- BHMA certified Grade 1 (1 million cycles)
- Surface or Mortised (full or half) types
- Wide throw, raised barrel, slip-in, swing clear & anchor models available
- Available in three bearing types and pin styles
- Available in many architectural finishes

Spring & Gravity Pivots



Horizontal
Spring Pivot



Spring Gate Pivot



Gravity Pivot

**High Quality,
Durable
Lavatory
Hardware**

Lavatory
Hinges

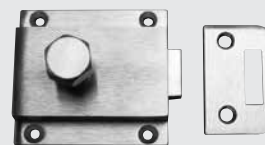

Rim bolt & keeper

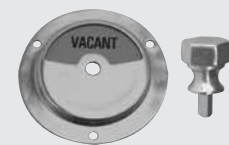

Occupancy indicator &
emergency key

Learn more at: www.bommer.com

Please contact your local Canaropa sales representative to order. Special orders may require additional delivery time and/or minimum order quantities.



CX5 technology was developed as an innovative and affordable solution to the limitations of common key cylinders in the fields of physical security and loss prevention.

Through high-precision manufacturing, uncompromising quality standards and original technologies, CX5 delivers

Better security for everyone!

www.cx5security.com

CX5
SECURITY SOLUTIONS



• MANAGED KEY CONTROL

Key control is critical for high security. A stolen or copied key is among the most common ways security is breached. CX5 keys are geographically managed and can only be cut by an authorized dealer when presented with a valid CX5 control card.

• ENHANCED ATTACK RESISTANCE

Common locks and cylinders can easily be picked or drilled, but CX5 cylinders, protected by hardened steel pins, are more resistant to drilling and other forms of physical attacks.

• MULTIPLE LOCKING POINTS

CX5 cylinders have spring-less side pins that must be aligned to release the side bar, acting as a secondary locking mechanism, making them pick and bump resistant. **The new Triio cylinders** include a patented third locking mechanism, making them even more resistant to pick and bump attacks.

• FLEXIBLE

CX5 cylinders are designed to accommodate a variety of leversets, knobsets, mortise locks, deadbolts, exit device trims and padlocks from various hardware manufacturers.

• EXPANDABLE

CX5 keying systems can be designed to grow with your keying requirements. **New Triio keys** are backward compatible with existing CX5 cylinders for seamless integration and enhanced security.

• AFFORDABLE

CX5 Security Solutions is committed to offering cost-effective high security solutions to everyone.

Triio Overview

Along with the CX5 Security Groove, the CX5 Triio keys have a specially designed and patented Security Indent on the key which interacts with a third locking mechanism, another side bar, within the Triio cylinder. With the key in place, the spring loaded Triio bar retracts from the cylinder housing and into the cylinder's plug, thereby allowing the key to turn.

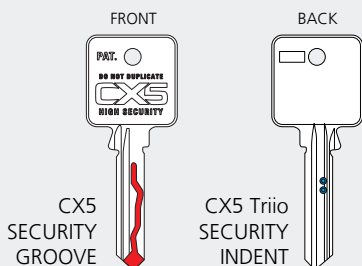

CX5 KIK cylinders are designed to fit most common commercial and residential lever, knob, and deadbolts.

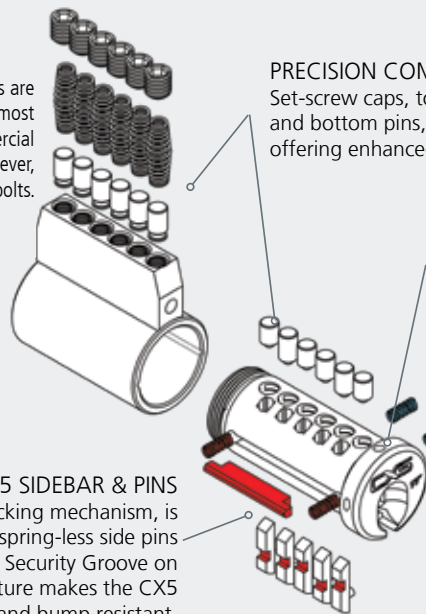

PRECISION COMPONENTS

Set-screw caps, top springs, mushroom pins and bottom pins, facilitate pinning while offering enhanced security.

HARDENED STEEL PINS

Offer drill resistance protection to critical components.

TRIO SIDEBAR

The third locking mechanism makes a Triio cylinder even more difficult to circumvent.

CX5 SIDEBAR & PINS
The second locking mechanism, is released when the spring-less side pins are aligned by the Security Groove on the key. This feature makes the CX5 cylinders pick and bump resistant.

Exploded view of a CX5 Triio 9115T KIK Cylinder



KIK / KIL CYLINDERS



RIM & MORTISE CYLINDERS



DEADBOLTS



SFIC BEST®



LFIC MEDECO®

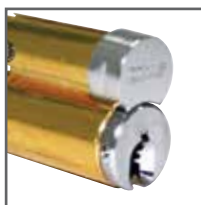

LFIC SCHLAGE®

Proven and Innovative High Security Technology Ideal For:

RESIDENTIAL APPLICATIONS

Condominiums & Suites
Apartment Buildings
Single Family Homes
Shared living spaces

INSTITUTIONAL APPLICATIONS

Hospitals
Medical Buildings
Government Offices
Schools & Universities
Utilities

COMMERCIAL APPLICATIONS

Retail Centers
Corporate Offices
IT / Data Centers
Warehousing / Storage
Factory / Plant Access
Heavy Equipment
Transport Security

Learn more at: www.cx5security.com

Please contact your local Canaropa sales representative to order. Special orders may require additional delivery time and/or minimum order quantities.

Better security for everyone!



Camden Door Controls is an industry-leading provider of innovative, high quality and competitively priced door activation, control and locking products for any access control or automatic door application. Camden Door Controls bring an unsurpassed combination of product quality, performance and value to every access control and automatic door project.

www.camdencontrols.com



ELECTRIC STRIKES

**ALL
NEW**



G1
C UL US LISTED
SECURITY UL LISTED

CX-ED1579L
ALL-IN-ONE, FIRE RATED
ELECTRIC STRIKE

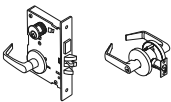

G1
C UL US LISTED
SECURITY UL LISTED

CX-EPD1289L
SURFACE MOUNTED, FIRE
RATED, RIM ELECTRIC STRIKE

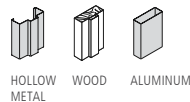

G1
SECURITY UL LISTED

CX-ED1379
NARROW STILE
ELECTRIC STRIKE

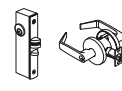
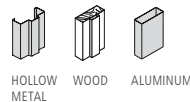

G1
C UL US LISTED
SECURITY UL LISTED

CX-ED1410
UNIVERSAL, FIRE RATED
ELECTRIC STRIKE



G1
SECURITY UL LISTED

CX-ED1079
LOW-PROFILE UNIVERSAL
ELECTRIC STRIKES (G1)

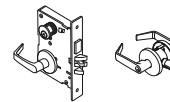
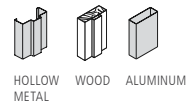

G2
SECURITY UL LISTED

CX-ED2079
LOW-PROFILE UNIVERSAL
ELECTRIC STRIKES (G2)

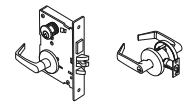

ELECTROMAGNETIC LOCKS



SECURITY
UL LISTED



CX-DE1200 « Exit Watch »
DELAYED EGRESS MAGNETIC LOCK
(1200 LBS)

- Nuisance delay period
- Voice and LED count-down timer
- Vandal resistant proximity trigger sensor
- Auto sensing power input with polarity protection
- Auto/manual start-up on power restore
- Anti-Pass back/Auto Re-Lock

SECURITY
UL LISTED
c RUL

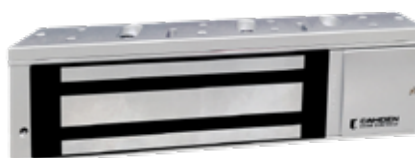

CX-915-12TDS
SINGLE DOOR MAGNETIC LOCK
(1200 LBS)

- Surface mount model
- Adjustable timer
- Door status switch
- Lock sensor/relay
- LED indicator
- Compatible with all access/egress systems
- Field selectable 12/24 VDC operation
- Weather and vandal resistant
- On board power surge protection

ACCESS CONTROL KITS & COMPONENTS



CX-WC13AXSM
BARRIER FREE RESTROOM CONTROL:

- Logic control board
- Narrow "Push to Open" and "Push to Lock" push plates with LED mounting box and sign
- Push plate with LED mounting box and sign
- Magnetic Contact, surface mounted

*Mounting boxes are surface mounted.
Power supply and electric strike are not included.*



CX-WEC10K2
EMERGENCY CALL FOR UNIVERSAL RESTROOMS:

- Double gang, emergency call button
- Single gang dome light with alarm
- Solid white sign (English / French)

Mounting boxes are not included.



KEY SWITCHES
CM-1105..... SPST, N/C
CM-1120..... SPDT, Momentary
N/O and N/C

MORTISE CYLINDER
SOLD SEPARATELY



CM-400
PUSH BUTTON STAINLESS STEEL FACEPLATE:

- 1 1/8" (40 mm) diameter button
- Vandal resistant free-spinning button
- Single gang stainless steel face plate
- Available in English or French



CM-AF500
LED ANNUNCIATORS:

- Bright LEDs for high visibility, even in daylight
- Text/graphics are not legible when not illuminated
- Vandal and weather resistant construction
- Single gang stainless steel face plate



CM-30C
SQUARE ILLUMINATED EXIT SWITCH:

- High visibility 2" (51 mm) square button
- Single gang with stainless steel faceplate
- Bright LED provides clarity and longevity
- Variety of bilingual labels



CV-110SPK
SLIM LINE CARD READER & KEYPAD
125KHz Reader

CV-110SK
SLIM LINE KEYPAD



CM-701U
BLUE PULL STATION

INCLUDED LABELS



PUSH PLATES
4 1/2 x 4 1/2 in (114 x 114 mm)
CONCEALED MOUNTING
CM-45/4..... English
CM-45/4F..... French

Mounting boxes not included.



MAGNETIC CONTACT
CX-MDH..... SPST, Recessed,
White

LOGIC RELAYS



CX-12 PLUS
DOOR INTERFACE RELAY
Designed for easy interconnection of automatic doors with access control, time control, telephone entry and fire alarm systems.



CX-33
ADVANCED LOGIC RELAY
Ideal for most automatic door applications, as well as air lock and other security applications.

MOUNTING BOXES



CM-34BL
SURFACE MOUNTED, SINGLE GANG

- Standard depth
- 2¾x4½x1¾in (70x114x44.5 mm)
- Single gang
- Provision for wireless
- Flame/impact resistant black ABS



CM-43LP
SURFACE MOUNTED, PUSH PLATE

- Shallow depth
- 5x5x1¾in (127x127x35 mm)
- Double gang
- Flame/impact resistant black ABS
- For use with CM-45/46 push plate



CM-43CBL
SURFACE MOUNTED, WIRELESS

- Standard depth
- 4½x4½x2 in (114x114x51 mm)
- Double gang
- Provision for wireless
- Flame/impact resistant black ABS



CM-43CBLA
SURFACE MOUNTED, HANDS FREE

- Standard depth
- 4½x4½x2 in (114x114x51 mm)
- Double gang
- Provision for wireless
- Flame/impact resistant black ABS
- For CM-324/325/330 hands free switches



Looking For More Camden Products?

OFFICIAL DISTRIBUTOR.

All Camden Door Control products are available through Canaropa.

Please contact your local Canaropa sales representative to order – special orders may require additional delivery time and/or minimum order quantities.

Learn more about Camden Door Control and their products at:
www.camdencontrols.com





Sigma Automatics are a leading provider of high-quality automatic door operators and equipment. With a wide range of innovative solutions made to accommodate different architectural designs and hardware requirements, their products are designed to meet the needs of any application.

www.sigmaautomatics.com

SIGMA 
AUTOMATICS

SA-300 LOW ENERGY SWING DOOR OPERATOR

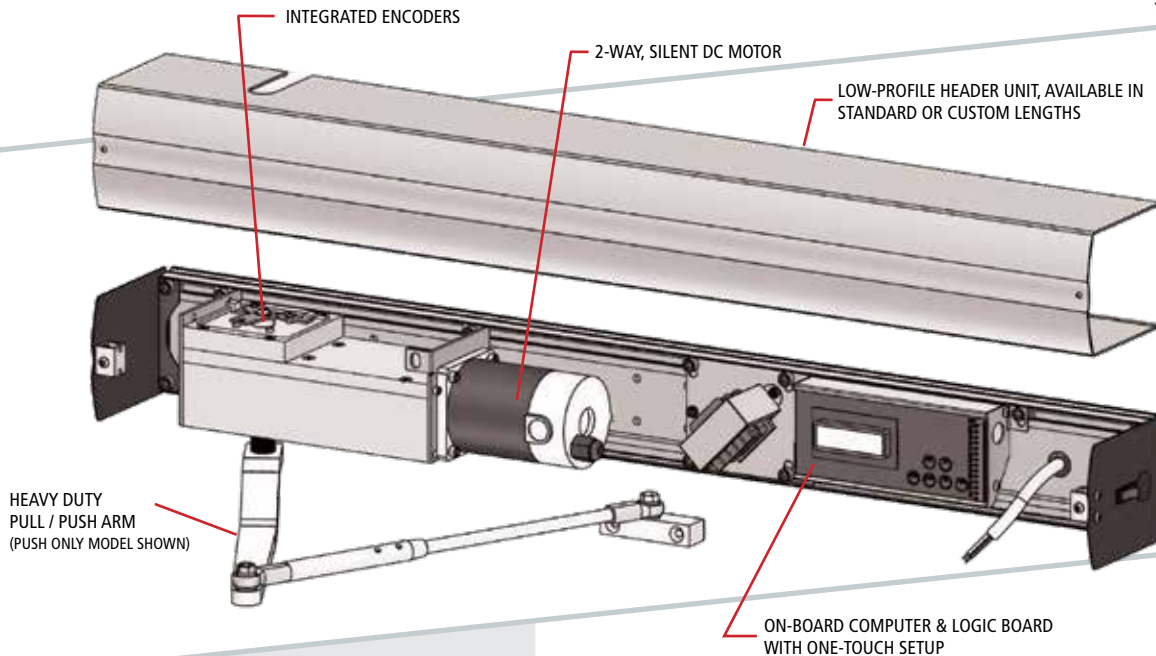

The SA-300 Series low energy swing door operator is ideal for use in exterior or interior entryways, corridors and various applications that occasionally require an automatic opening. Common applications include libraries, retail, education and assisted living buildings, facilities or areas.

The SA-300 Series electro-mechanical door operators are suitable for use on all types of doors, including large and heavy doors. It can be surface mounted either side of an opening for push/pull operation. The SA-300 Series operator can be used with single doors, double doors (simultaneous) and double egress (opposing door swing) doors fitted with standard hinges, and can be connected to a door with a range of different arm systems.

The SA-300 Series can replace existing manual door closers, converting openings into automated ones easily while still being manually opened with ease.

The SA-300 is an all-weather device, and is not affected by stack pressure or wind load when operating.

Other model series include concealed operators for swing clear hinges, offset pivots or center pivots – please contact your local sales representative for details.

SMART DOOR OPERATOR

Integrated logic board allows for one-touch setup and easy integration with card readers, sensors, push buttons, electric strikes, and other electrified hardware.

PUSH OR PULL APPLICATIONS

Can be used in either configuration and can be field converted from one mode to the other. No arm additional arm kits required.

SINGLE OR DOUBLE DOOR

Can be configured for paired doors for simultaneous one-way swing or opposing swings (dual egress) or paired with a manual door closer.

LOW PROFILE AND VERSATILE

Low profile, modern design that can be surface mounted, or concealed in the floor or transom.

WIND BRAKE AND PRESSURE COMPENSATION

Automatically counteracts wind forces and pressure changes.

COLLISION DETECTION

Automatically reverses swing when encountering an obstacle.

POWER ASSIST

Automatically opens when door is pushed (Push&Go) and can provide additional power (Lock Kick) to close and latch the door.

ON BOARD POWER

Power connected devices, sensors, and lights with on-board 24V power.

BUILT-TOUGH

Fire-rated and designed for heavy use, backed by a two-year warranty.

SPECIFICATIONS

- Certifications**
- Conforms to ANSI/BHMA A156.19 for low energy door operators
 - cULus listed; conforms to UL 325, UL 228, UL10C (3hr) and CSA Std.C22.2 #247
 - ADA Compliant
 - 2-Year limited warranty

- Type**
- Commercial low energy automatic swing door operator with integrated logic board

- Handing**
- Handed, field reversible¹
 - Field reversible swing (push to pull or vice versa)²
- (1) Operators are delivered Right Hand by default
 (2) Included arm converts between «pull» and «push»

- Capacity**
- 480 lbs (217 kg) per door leaf
 - 48" (122 cm) maximum door leaf width
- Based on prevailing conditions at door opening.

- Control Type**
- Microprocessor with digital display

- Opening**
- 120° maximum

- Reveal**
- Up to 12" (304.8 mm) for PUSH applications
 - Up to 6" (152.4 mm) for PULL applications

- Finish** 628–Anodized aluminum, 711–Anodized Black
 Other finishes available by special order

- Electronic Features**
- One-touch, self-learning, auto-configuration setup
 - Interfaces with access control devices
 - Works with all major sensors, including BEA LZR and Optex Elite Pro
 - Operates as mechanical closer during power failures
 - Dual operators can operate independently (Dual-Egress) or simultaneously
 - Power Assist (Push&Go) for automatic door opening when pushed
 - Lock Retry and Lock Kick to ensure proper latching
 - Wind Force Dampening (Wind-Brake) to counteract wind forces
 - Pressure Compensation to counteract positive, negative and sudden pressure changes for smooth operation
 - Built-in encoders track door position, even after a power failure
 - Built-in obstacle detection, expandable with sensors (sold separately)
 - Mechanical door stop (80° to 120°)
 - Programmable sweep and latching speeds
 - Programmable cushioning backcheck
 - Programmable delayed action

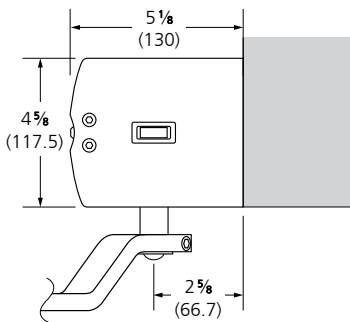

TECHNICAL DATA

Electrical

- Power supply: 115V AC, 60HZ
- Power consumption: Max. 100W, draws 500mA
- Auxiliary output voltage: 24 VDC up to 1A
- Fuse type: 5A @ 500V, Slow-Blow
- Electric lock relay type: MOSFET
- Lock relay rating: 5.7A @ 100VDC (limited to 1.1A @ 24VDC)

Motor

- Rating: 18VDC
- Type: Permanent Magnet (PM) Silent

Environmental

- Operating temp. : -40° to 50°C (-40° to 122°F)
- Relative humidity: Max. 100%

SELECTION GUIDE

MODEL	DESCRIPTION	HANDING / OPERATION	LENGTH*	FINISH*
FOR STANDARD SWING DOORS		REVERSIBLE HANDING / REVERSIBLE OPERATION		
300	Surface mounted, single operator	LEFT HAND-L (PULL-PL) / RIGHT HAND-R (PULL-PL)	41 (1041.4)	Clear (628)
320	Surface mounted, paired operators, simultaneous one-direction opening <i>Dual Egress (opposing swings) available - indicate DE when ordering.</i>		76 (1930.4)	
350	Surface mounted, single operator paired with surface door closer mounting plate (door closer sold separately) ¹	RIGHT HAND-R (PUSH-PS) / LEFT HAND-L (PUSH-PS)		

IN (MM) (*) CUSTOM HEADER LENGTHS AND OTHER FINISHES AVAILABLE BY SPECIAL ORDER. (1) DOREX 441HD SURFACE DOOR CLOSER RECOMMENDED.

NOTE: CONCEALED, PIVOT AND SWING-CLEAR MODELS ARE AVAILABLE BY SPECIAL ORDER.

ALL MODELS INCLUDE	All SA-300 swing door operators have a clutch-less gear box and a push/pull arm that allows the operator to drive the door in either direction. Ideal for heavy over-sized doors or high stack pressure or heavy wind conditions.
---------------------------	---

TO ORDER

SA - 300 - 41 - 628
 MODEL LENGTH FINISH

DELIVERED RIGHT HAND WITH PUSH/PULL ARM BY DEFAULT. FIELD REVERSIBLE.

For more information about the SA-300, similar and complimentary products, please contact your local Canaropa sales representative.

PARTS



SA-PSN/PLN PUSH/PULL ARM ASSEMBLY

- Convertable from push arm to pull arm
- Heavy-duty, cast alloy construction
- Available in dark bronze (668)

COMPLEMENTARY ACCESSORIES



CX-ED1379 NARROW STILE ELECTRIC STRIKE

- For cylindrical and mortise locksets with spring latches
- Selectable Fail Safe/Fail Secure
- Selectable 12/24V, AC/DC
- ½ to ¾" (12.7 – 16 mm) latch projection
- Easy fit connectors
- A range of aluminum and dark bronze face plates

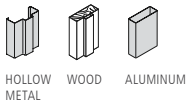

HOLLOW METAL WOOD ALUMINUM



CM-RQE7A



CM-RQE7ABK

CM-RQE70A

PIR "REQUEST TO EXIT" SENSOR:

- Compact design for door frames
- Easy to use on-board programming
- (4) Factory default operating modes, with the ability to customize mode attributes
- Selectable fail safe/fail secure
- (2) Form 'C' contacts
- Momentary and latching relay modes
- Secondary activation device input
- Card/keypad input
- Door position switch input
- Request to Exit input
- Built-in sounder (adjustable)
- Tamper switch



CM-400

PUSH BUTTON STAINLESS STEEL FACEPLATE:

- 1 ¾" (40 mm) diameter button
- Vandal resistant free-spinning button
- Single gang stainless steel face plate
- Available in English or French



CM-45

4 ½ x 4 ½ in (114 x 114 mm) PUSHPLATE:

- ADA Compliant
- Hidden mounting screws
- Stainless steel push plate
- Available in English or French

Mounting boxes are not included.



CX-WEC10K2

EMERGENCY CALL KIT FOR UNIVERSAL RESTROOMS:

- Complete kit
- Double gang, emergency call button with annunciator
- Single gang dome light with alarm
- Solid white sign (English / French)

Mounting boxes are not included.



CM-AF500

LED ANNUNCIATORS:

- Bright LEDs for high visibility, even in daylight
- Text/graphics are not legible when not illuminated
- Vandal and weather resistant construction
- Single gang stainless steel face plate



CM-30C

SQUARE ILLUMINATED EXIT SWITCH:

- High visibility 2" (51 mm) square button
- Single gang with stainless steel faceplate
- Bright LED provides clarity and longevity
- Variety of bilingual labels



National Guard Products (NGP) specializes in manufacturing and distributing high-quality weather-stripping, door sweeps, thresholds, perimeter seals, and more. Products designed to meet the needs of commercial and institutional building projects to improve energy efficiency, provide soundproofing and enhance security.

www.ngp.com



AUTOMATIC DOOR BOTTOMS



220NA-36

NEOPRENE - 36 in

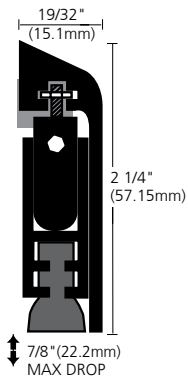

335N-36

NEOPRENE - 36 in

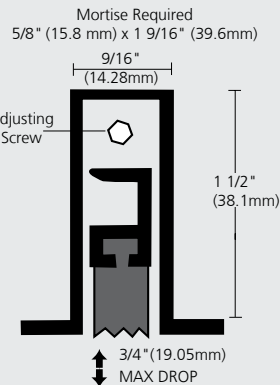

320V-36

MILL ALUMINUM WITH VINYL SEAL - 36 in

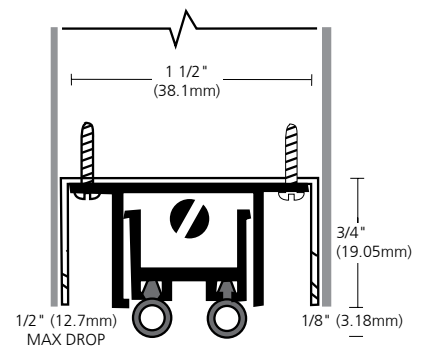

DOOR SEALS



5050B-17
GASKET

BROWN GASKET - 17 ft

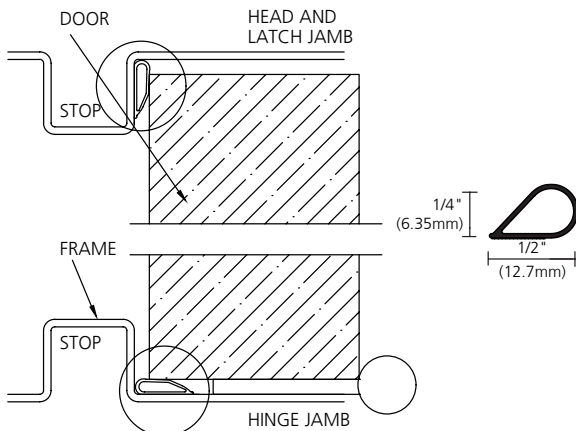

155V-17
PERIMETER SEAL

MILL ALUMINUM WITH VINYL SEAL - 17 ft

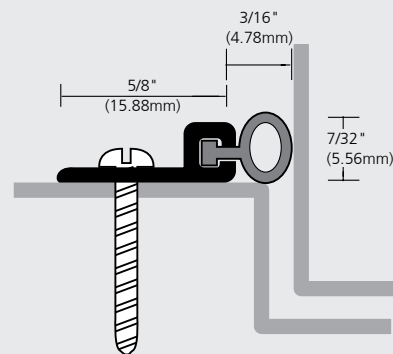

DOOR SWEEPS



200NA-36

ANODIZED ALUMINUM NEOPRENE - 36 in

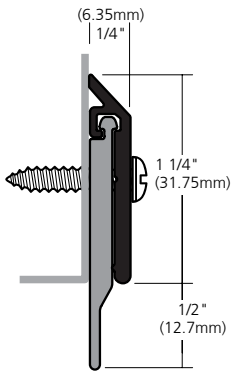

601A-36

ANODIZED ALUMINUM - 36 in

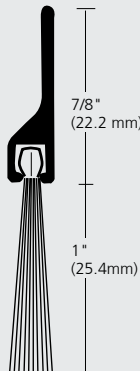

C627A-36

ANODIZED ALUMINUM - 36 in

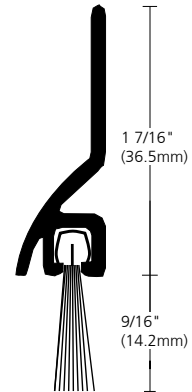

OVERLAPPING ASTRAGALS



158NA-7

ANODIZED ALUMINUM WITH NGP TPV SEAL - 7 ft

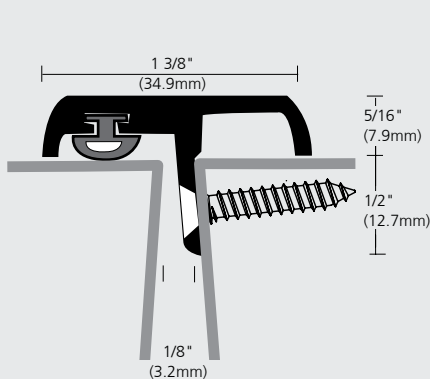

THERMAL BREAK SADDLE THRESHOLDS



8425-36

8425-36 MILL ALUMINUM - 36 in
8435V-36 SILICONE - 36 in

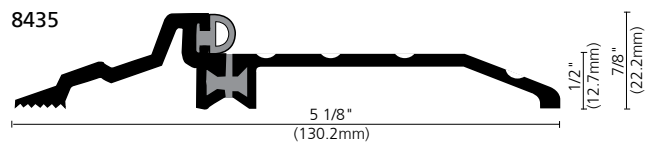
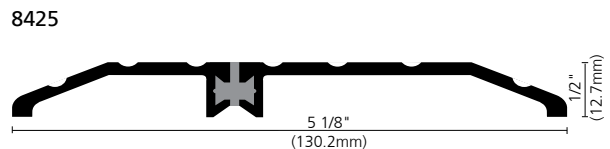

Looking for more NGP products?

Discover the full range of National Guard Products (NGP) and delve deeper into their offerings by visiting

www.ngp.com

OFFICIAL DISTRIBUTOR.

All National Guard Products (NGP) products are available through Canaropa.

Please contact your local Canaropa sales representative to order – special orders may require additional delivery time and/or minimum order quantities.



CERTIFIED by UL to CAN/ULC-S104 and ANSI/UL10B, complies with NFPA 80 and NFPA 252 for application to Hollow Metal fire doors rated up to 3 Hrs., and Wood fire doors rated up to 90 minutes.



POSITIVE PRESSURE - CERTIFIED by UL to ANSI/UL10C, complies with IBC, NFPA 80 and NFPA 252 for application to Hollow Metal fire doors rated up to 3 Hrs., and Wood fire doors rated up to 90 minutes.



SMOKE & DRAFT CONTROL GASKETING. Certified by UL to ANSI/UL10C and ANSI/UL1784 Category 'H'; complies with IBC and NFPA 105 for use on 'S' labeled Positive Pressure Hollow Metal fire doors rated up to 3 hours, and Wood fire doors rated up to 90 minutes.



AIR INFILTRATION TESTED to ASTM E283, Standard Test Method for Determining Rate of Air Leakage Through Exterior Windows, Curtain Walls, and Doors.



ACOUSTICAL TESTED to ASTM E90 Standard Test Method for Laboratory Measurement of Airborne Sound Transmission Loss of Building Partitions and Elements, and ASTM E2235 Standard Test Method for Determination of Decay Rates for use in Sound Insulation Test Methods. Refer to information on pages G4 and G5 of our Gasketing catalogue for test result data.



SMOKE & DRAFT CONTROL GASKETING. Door Sweep Application only. Certified by UL to ANSI/UL10C and ANSI/UL1784 Category 'H'; complies with IBC and NFPA 105 for use on 'S' labeled Positive Pressure Hollow Metal fire doors rated up to 3 hours, and Wood fire doors rated up to 90 minutes.



NGP-EDGE® SEALING SYSTEM. Certified by UL to ANSI/UL10C Category 'G'; required for Category B wood fire doors to meet positive pressure requirements complying with IBC, and NFPA 252. See individual products for maximum door size and ratings.



ADA COMPLIANT. Barrier Free Thresholds meet the requirements of the ADA Standard for Accessible Design and ICC/ANSI A117.1 Accessible and Usable Buildings and Facilities.



ANSI/BHMA CERTIFIED. Certified thresholds comply with American National Standard for Thresholds ANSI/BHMA A156.21 1,000 lb. load test and are listed in the BHMA Certified Products Directory.





Perko concealed door closers have been closing doors in a wide variety of commercial, residential, and institutional buildings for over 30 years, establishing themselves as the preferred choice for specifiers and contractors.

www.perkopower.com

PERKO

PERKO

Perko

- The original Perko concealed door closer
- Non-handed
- Solid brass anchor plates
- Adjustable spring mechanism
- For interior doors up to 110lbs (50kg)
- Various finishes available on special order

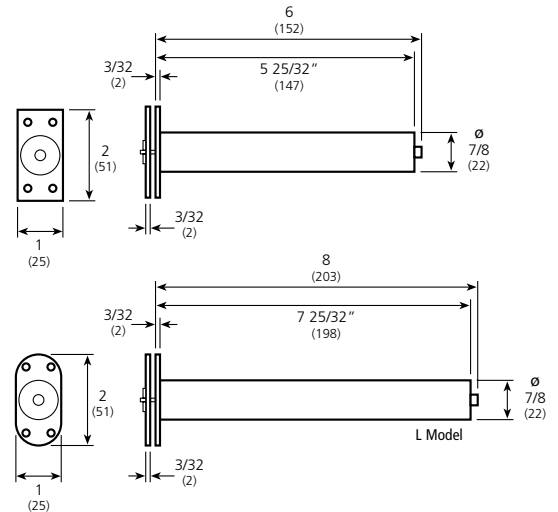

Perkomatic

- Non-handed
- Solid brass anchor plates
- Adjustable spring and hydraulic mechanism
- For interior doors up to 165 lbs (75kg)
- Various finishes available on special order

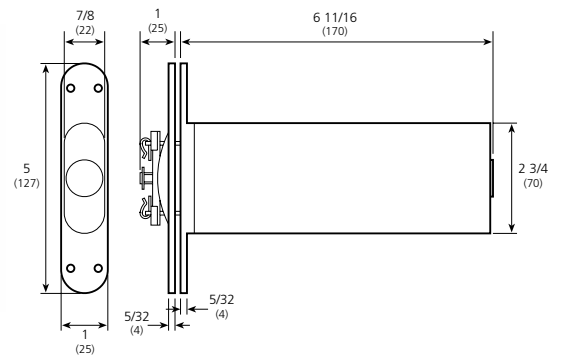

Perkopower

- Fits 1 1/4 to 1 3/4" (31.8 to 44.5mm) door thicknesses
- For doors up to 176lbs (80kg) in weight and 37 1/2" (950mm) wide
- Conforms to ANSI 156.4 and ADA maximum opening force
- Conforms to power size 3 on controlled door closing device
- Suitable for latched and unlatched installations
- Adjustable closing speed and latching action
- Endurance tested to 500,000 closing cycles
- Unique twin power mechanism for extra closing force
- Various finishes available on special order

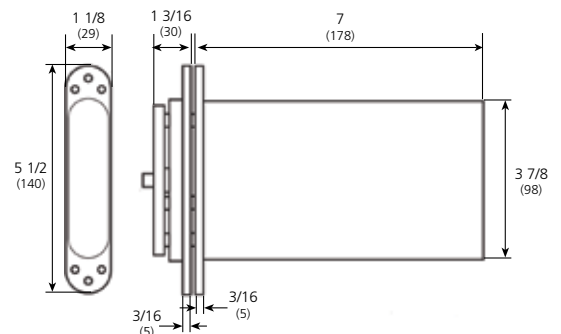

Learn more at: www.perkopower.com

Please contact your local Canaropa sales representative to order. Special orders may require additional delivery time and/or minimum order quantities.



SOSS offers a unique range of products, from their famous invisible hinges to their unique Ultralatch® push-pull door latch. SOSS products can be installed in wood, metal and plastic doors and are used in a wide variety of applications from windows, cabinets, and partitions to office, commercial, and medical applications.

www.soss.com

SOSS

Invisible Hinges



- For wood and metal doors
- Cannot be seen or tampered with when closed
- Available in a wide range of sizes
- Smooth operation
- Fire rated models available
- Power transfer hinge model available
- Available in a variety of finishes



Ultralatch® Push/Pull Lockset



- Single acting, Grade 1 push/pull latch
- Meets ADA requirements
- For doors 1 3/8" (35 mm); 1 3/4" (44.5 mm); 2" (50 mm) thick
- 2 3/8" (60 mm) or 2 3/4" (70 mm) backset
- Privacy, passage, and dummy functions available
- Available in a variety of finishes



Invisible Spring Door Closer

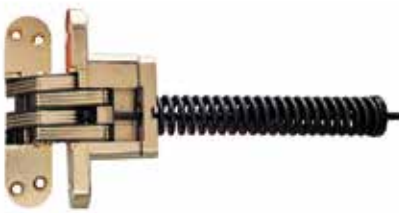

- For light to heavy wood doors
- Cannot be seen or tampered with when closed
- Adjustable closure speed
- Opens 180°
- Available in a variety of finishes



Other Product



BARREL HINGES



MAGNETIC DOOR
HOLDERS AND STOPS

- Wide variety of invisible hinges
- Specialty hinges
- **And more**

Learn more at: www.soss.com

Please contact your local Canaropa sales representative to order. Special orders may require additional delivery time and/or minimum order quantities.



Since 1942, the Viro brand has become synonymous with quality security hardware all over the world. Viro offers a wide range of security and door products to satisfy many different applications.

www.viro.it

Viro

PROPERTY SECURITY



Protect them with VAN LOCK

- Patented, hardened shape prevents gripping and smashing attacks.
- Stainless steel construction prevents corrosion.
- Emergency unlocking from inside prevents accidental lock-in.
- Installs on any door, regardless of misalignment.



Heavy Duty Armoured Padlocks

PANZER



1000 SERIES

Cabinet Locks



Quality Keyable Padlocks

MARINE

BRASS



V06 DEADBOLT

Electrified Gate / Garage Door Locks and Strikes



9083 LOCK

DOOR SECURITY

Forced Entry Protection



SPRANGA LOCKING BAR



7400 SERIES MORTISE LOCKS FOR CONVENTIONAL DOORS



8500 SERIES MORTISE LOCKS FOR METAL FRAME DOORS



CONVENTIONAL & HIGH SECURITY PROFILE CYLINDERS

Bicycle, Scooter and Motorcycle Security



BLACK MAMABA BURGLAR LOCK



SHARK DISC LOCKS



BLOCCA CATENA CHAIN & PADLOCK

**Disc Locks
Burglar Locks
Cable Locks
U-Locks
Chains & Padlocks**

Learn more at: www.viro.it

Please contact your local Canaropa sales representative to order. Special orders may require additional delivery time and/or minimum order quantities.



Architectural Builders Hardware Mfg. Inc. (ABH) has been manufacturing the highest quality products for the past 20 years. Through the implementation of Robotics, Automation and Lean Manufacturing, ABH has been able to efficiently manufacture products at the highest quality standards.

www.abhmfg.com

ABH[®]

Choose from a variety of products



OVERHEAD
HOLDERS & STOPS



ELECTROMAGNETIC
DOOR HOLDERS



ALUMINUM
CONTINUOUS
GEARED HINGES



PIVOTS &
PIVOT SETS



RESCUE
HARDWARE



STAINLESS STEEL
PIN & BARREL
HINGES

HOSPITAL
PUSH / PULL
LATCHES

ELECTRICAL
POWER
TRANSFERS

OTHER PRODUCTS:



PIN & BARREL HINGES



EDGE GUARDS



ROLLER LATCHES

- Surface Bolts and Slide Bolts
- Custom strikes and pivots
- **And more**

FEATURES AND BENEFITS

- Anti-microbial coating available
- Most products are UL listed
- Most products are stainless steel
- Available in a variety of BHMA finishes
- Custom sizes and finishes available

Learn more at: www.abhmfg.com

Please contact your local Canaropa sales representative to order. Special orders may require additional delivery time and/or minimum order quantities.



Bommer Industries Builders Hardware Division continues the trademarks of quality and innovation that were founded in 1876. Bommer offers a complete line of Architectural Grade Butt Hinges, our industry leading line of Single Acting Spring Hinges, the world renowned Double Acting Spring Hinges, Specialty Door and Gate Pivots, and high quality Lavatory Hardware.

www.bommer.com



Single & Double Acting Spring Hinges



Single

- cULus listed
- BHMA certified Grade 1 (1 million cycles)
- Patented
- Available in many architectural finishes



Double

- Patented
- Available in many architectural finishes

BHMA Certified Architectural Hinges



5 knuckle,
bottom tip



3 knuckle,
flush tip

- cULus listed
- BHMA certified Grade 1 (1 million cycles)
- Surface or Mortised (full or half) types
- Wide throw, raised barrel, slip-in, swing clear & anchor models available
- Available in three bearing types and pin styles
- Available in many architectural finishes

Spring & Gravity Pivots



Horizontal
Spring Pivot



Spring Gate Pivot



Gravity Pivot

**High Quality,
Durable
Lavatory
Hardware**

Lavatory
Hinges

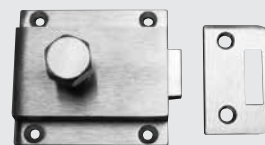

Rim bolt & keeper



Occupancy indicator &
emergency key

Learn more at: www.bommer.com

Please contact your local Canaropa sales representative to order. Special orders may require additional delivery time and/or minimum order quantities.



CX5 technology was developed as an innovative and affordable solution to the limitations of common key cylinders in the fields of physical security and loss prevention.

Through high-precision manufacturing, uncompromising quality standards and original technologies, CX5 delivers

Better security for everyone!

www.cx5security.com

CX5
SECURITY SOLUTIONS



• MANAGED KEY CONTROL

Key control is critical for high security. A stolen or copied key is among the most common ways security is breached. CX5 keys are geographically managed and can only be cut by an authorized dealer when presented with a valid CX5 control card.

• ENHANCED ATTACK RESISTANCE

Common locks and cylinders can easily be picked or drilled, but CX5 cylinders, protected by hardened steel pins, are more resistant to drilling and other forms of physical attacks.

• MULTIPLE LOCKING POINTS

CX5 cylinders have spring-less side pins that must be aligned to release the side bar, acting as a secondary locking mechanism, making them pick and bump resistant. The new Triio cylinders include a patented third locking mechanism, making them even more resistant to pick and bump attacks.

• FLEXIBLE

CX5 cylinders are designed to accommodate a variety of leversets, knobsets, mortise locks, deadbolts, exit device trims and padlocks from various hardware manufacturers.

• EXPANDABLE

CX5 keying systems can be designed to grow with your keying requirements. New Triio keys are backward compatible with existing CX5 cylinders for seamless integration and enhanced security.

• AFFORDABLE

CX5 Security Solutions is committed to offering cost-effective high security solutions to everyone.

Triio Overview

Along with the CX5 Security Groove, the CX5 Triio keys have a specially designed and patented Security Indent on the key which interacts with a third locking mechanism, another side bar, within the Triio cylinder. With the key in place, the spring loaded Triio bar retracts from the cylinder housing and into the cylinder's plug, thereby allowing the key to turn.

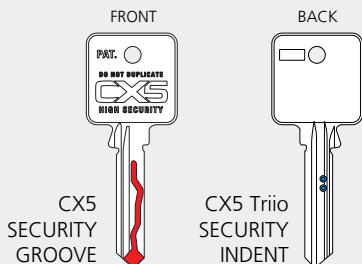

CX5 KIK cylinders are designed to fit most common commercial and residential lever, knob, and deadbolts.

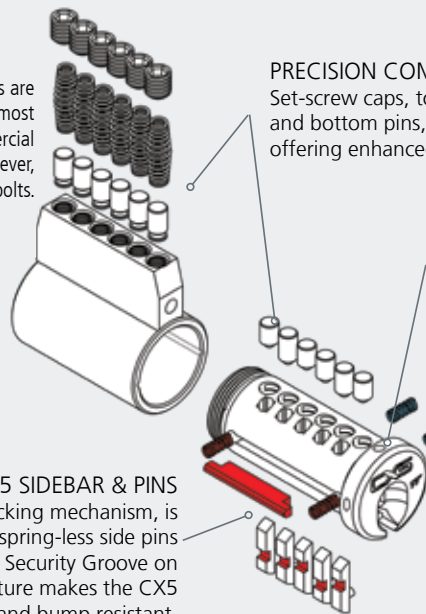

PRECISION COMPONENTS

Set-screw caps, top springs, mushroom pins and bottom pins, facilitate pinning while offering enhanced security.

HARDENED STEEL PINS

Offer drill resistance protection to critical components.

TRIO SIDEBAR

The third locking mechanism makes a Triio cylinder even more difficult to circumvent.

CX5 SIDEBAR & PINS
The second locking mechanism, is released when the spring-less side pins are aligned by the Security Groove on the key. This feature makes the CX5 cylinders pick and bump resistant.

Exploded view of a CX5 Triio 9115T KIK Cylinder



KIK / KIL CYLINDERS



RIM & MORTISE CYLINDERS



DEADBOLTS



SFIC BEST®



LFIC MEDECO®

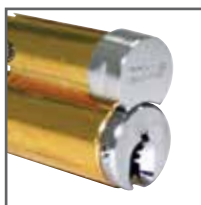

LFIC SCHLAGE®

Proven and Innovative High Security Technology Ideal For:

RESIDENTIAL APPLICATIONS

Condominiums & Suites
Apartment Buildings
Single Family Homes
Shared living spaces

INSTITUTIONAL APPLICATIONS

Hospitals
Medical Buildings
Government Offices
Schools & Universities
Utilities

COMMERCIAL APPLICATIONS

Retail Centers
Corporate Offices
IT / Data Centers
Warehousing / Storage
Factory / Plant Access
Heavy Equipment
Transport Security

Learn more at: www.cx5security.com

Please contact your local Canaropa sales representative to order. Special orders may require additional delivery time and/or minimum order quantities.

Better security for everyone!



Camden Door Controls is an industry-leading provider of innovative, high quality and competitively priced door activation, control and locking products for any access control or automatic door application. Camden Door Controls bring an unsurpassed combination of product quality, performance and value to every access control and automatic door project.

www.camdencontrols.com



ELECTRIC STRIKES



BHMA
G1
UL US LISTED
SECURITY UL LISTED

CX-ED1579L
ALL-IN-ONE, FIRE RATED
ELECTRIC STRIKE

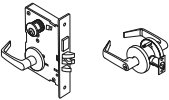

BHMA
G1
UL US LISTED
SECURITY UL LISTED

CX-ED1420
UNIVERSAL, FIRE RATED
ELECTRIC STRIKE



BHMA
G1
SECURITY UL LISTED

CX-ED1079
LOW-PROFILE UNIVERSAL
ELECTRIC STRIKE

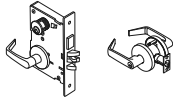
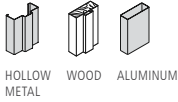

BHMA
G1
SECURITY UL LISTED

CX-ED1379
NARROW STILE
ELECTRIC STRIKE

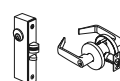
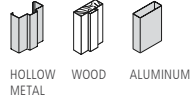

BHMA
G1
UL US LISTED
SECURITY UL LISTED

CX-ED1410
UNIVERSAL, FIRE RATED
ELECTRIC STRIKE



BHMA
G2
SECURITY UL LISTED

CX-ED2079
LOW-PROFILE UNIVERSAL
ELECTRIC STRIKE

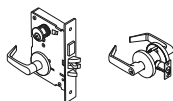
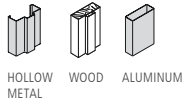

CX-EPD1289L
SURFACE MOUNTED,
FIRE RATED, RIM
ELECTRIC STRIKE

Grade 1 surface mount RIM strike, with latch monitoring, offers a 'Universal' strike design

BHMA G1 UL US LISTED SECURITY UL LISTED

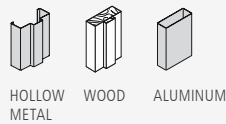

ELECTROMAGNETIC LOCKS



SECURITY
UL LISTED

CX-DE1200 « Exit Watch »
DELAYED EGRESS MAGNETIC LOCK
(1200 LBS)

- Nuisance delay period
- Voice and LED count-down timer
- Vandal resistant proximity trigger sensor
- Auto sensing power input with polarity protection
- Auto/manual start-up on power restore
- Anti-Pass back/Auto Re-Lock



SECURITY
UL LISTED

CX-915-12TDS
SINGLE DOOR MAGNETIC LOCK
(1200 LBS)

- Surface mount model
- Adjustable timer
- Door status switch
- Lock sensor/relay
- LED indicator
- Compatible with all access/egress systems
- Field selectable 12/24 VDC operation
- Weather and vandal resistant
- On board power surge protection



ACCESS CONTROL KITS



CX-WC13AXSM
BARRIER FREE RESTROOM CONTROL:

- Logic control board
- Narrow "Push to Open" and "Push to Lock" push plates with LED mounting box and sign
- Push plate with LED mounting box and sign
- Magnetic Contact, surface mounted

*Mounting boxes are surface mounted.
Power supply and electric strike are not included.*



CX-WEC10K2
EMERGENCY CALL FOR UNIVERSAL RESTROOMS:

- Double gang, emergency call button
- Single gang dome light with alarm
- Solid white sign (English / French)

Mounting boxes are not included.

ACCESS CONTROL COMPONENTS



CM-30C
SQUARE ILLUMINATED EXIT SWITCH:

- High visibility 2" (51 mm) square button
- Single gang with stainless steel faceplate
- Bright LED provides clarity and longevity
- Variety of bilingual labels



KEY SWITCHES

CM-1105..... SPST, N/C
CM-1120..... SPDT, Momentary N/O and N/C
CM-170/24..... SPDT, Momentary

MORTISE CYLINDER
SOLD SEPARATELY



CM-400
PUSH BUTTON STAINLESS STEEL FACEPLATE:

- 1 5/8" (40 mm) diameter button
- Vandal resistant free-spinning button
- Single gang stainless steel face plate
- Available in English or French



CM-701U
BLUE PULL STATION

INCLUDED LABELS



CM-AF500
LED ANNUNCIATORS:

- Bright LEDs for high visibility, even in daylight
- Text/graphics are not legible when not illuminated
- Vandal and weather resistant construction
- Single gang stainless steel face plate

READERS & KEYPADS



CV-110SPK
SLIM LINE CARD READER & KEYPAD
125KHz Reader



CM-110SK
SLIM LINE KEYPAD

MAGNETIC CONTACT



MAGNETIC CONTACT
CX-MDH..... SPST, Recessed, White



MAGNETIC CONTACT
CX-MDA..... SPST, White

PUSH PLATES



CM-45/4 **CM-45/4F**

PUSH PLATES
4 1/2 x 4 1/2 in (114.3 x 114.3 mm)
CONCEALED MOUNTING

CM-45/4..... English
CM-45/4F..... French
CM-45/2..... Signage
CM-45/K2..... Wireless



CM-60/4 **CM-60/F**

ROUND PUSH PLATES
6 in Round (152.4 x 152.4 mm)
CONCEALED MOUNTING

CM-60/4..... English
CM-60/4F..... French
Mounting boxes not included.



CM-45/2 **CM-45/K2**



CM-40/2

CM-40/2
4.5in Round (114.3mm)
CONCEALED MOUNTING
Mounting boxes not included.

PUSH PLATE SWITCHES

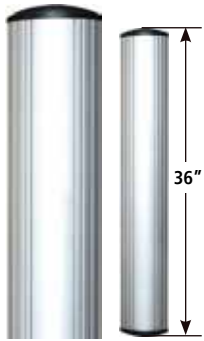

**CM-7536/1
COLUMN PUSH PLATE SWITCH**

- Aluminum push plate 36x 6in (mm)
- Surface mounted
- OBC, NBC, & CSA compliant
- Also available in dark bronze

POWER SUPPLY



**CX-PS150UL
POWER SUPPLY**

- 12/24 VDC selectable 1.7 Amp output
- AC and DC power and status indicators
- UL 294 and ULC S533
- 120 VAC power input
- Built in battery charger (500mA)

MOUNTING BOXES



CM-34BL

SURFACE MOUNTED, SINGLE GANG

- Standard depth
- 2 3/4 x 4 1/2 x 1 3/4 in (70 x 114 x 44.5 mm)
- Single gang
- Provision for wireless
- Flame/impact resistant black ABS



CM-43LP

SURFACE MOUNTED, PUSH PLATE

- Shallow depth
- 5 x 5 x 1 3/8 in (127 x 127 x 35 mm)
- Double gang
- Flame/impact resistant black ABS
- For use with CM-45/46 push plate



CM-43CBL

SURFACE MOUNTED, WIRELESS

- Standard depth
- 4 1/2 x 4 1/2 x 2 in (114 x 114 x 51 mm)
- Double gang
- Provision for wireless
- Flame/impact resistant black ABS



CM-43CBLA

SURFACE MOUNTED, HANDS FREE

- Standard depth
- 4 1/2 x 4 1/2 x 2 in (114 x 114 x 51 mm)
- Double gang
- Provision for wireless
- Flame/impact resistant black ABS
- For CM-324/325/330 hands free switches



CM-69S

ROUND MOUNTING BOXES - SURFACE

- Standard depth
- 6.25in x 6.25in x 2in (158.75x 158.75x 50.8 mm)
- Provision for wireless
- Flame/impact resistant black ABS

LOGIC RELAYS



CX-12 PLUS

DOOR INTERFACE RELAY

Designed for easy interconnection of automatic doors with access control, time control, telephone entry and fire alarm systems.



CX-33

ADVANCED LOGIC RELAY

Ideal for most automatic door applications, as well as air lock and other security applications.



Looking For More Camden Products?

OFFICIAL DISTRIBUTOR.

All Camden Door Control products are available through Canaropa.

Please contact your local Canaropa sales representative to order – special orders may require additional delivery time and/or minimum order quantities.

Learn more about Camden Door Control and their products at:
www.camdencontrols.com



CM-RX-90

**V2 KINETIC/LAZERPOINT
ADVANCED 1 RELAY RECEIVER**



CM-RX-91

**BASIC SINGLE RELAY
RECEIVER**



CM-RX-92

**FULL FUNCTION DUAL
RELAY RECEIVER**



CM-TX-9

**WALL SWITCH
TRANSMITTER**





Sigma Automatics are a leading provider of high-quality automatic door operators and equipment. With a wide range of innovative solutions made to accommodate different architectural designs and hardware requirements, their products are designed to meet the needs of any application.

www.sigmaautomatics.com

SIGMA 
AUTOMATICS

SA-300 LOW ENERGY SWING DOOR OPERATOR

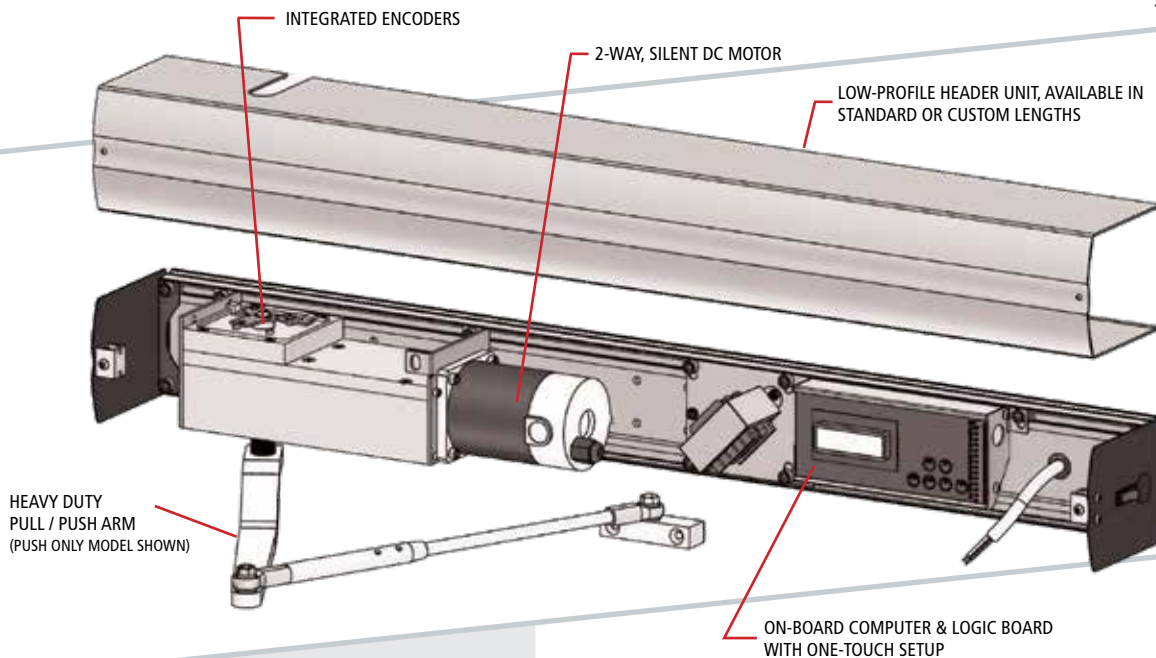

The SA-300 Series low energy swing door operator is ideal for use in exterior or interior entryways, corridors and various applications that occasionally require an automatic opening. Common applications include libraries, retail, education and assisted living buildings, facilities or areas.

The SA-300 Series electro-mechanical door operators are suitable for use on all types of doors, including large and heavy doors. It can be surface mounted either side of an opening for push/pull operation. The SA-300 Series operator can be used with single doors, double doors (simultaneous) and double egress (opposing door swing) doors fitted with standard hinges, and can be connected to a door with a range of different arm systems.

The SA-300 Series can replace existing manual door closers, converting openings into automated ones easily while still being manually opened with ease.

The SA-300 is an all-weather device, and is not affected by stack pressure or wind load when operating.

Other model series include concealed operators for swing clear hinges, offset pivots or center pivots – please contact your local sales representative for details.

SMART DOOR OPERATOR

Integrated logic board allows for one-touch setup and easy integration with card readers, sensors, push buttons, electric strikes, and other electrified hardware.

PUSH OR PULL APPLICATIONS

Can be used in either configuration and can be field converted from one mode to the other. No arm additional arm kits required.

SINGLE OR DOUBLE DOOR

Can be configured for paired doors for simultaneous one-way swing or opposing swings (dual egress) or paired with a manual door closer.

LOW PROFILE AND VERSATILE

Low profile, modern design that can be surface mounted, or concealed in the floor or transom.

WIND BRAKE AND PRESSURE COMPENSATION

Automatically counteracts wind forces and pressure changes.

COLLISION DETECTION

Automatically reverses swing when encountering an obstacle.

POWER ASSIST

Automatically opens when door is pushed (Push&Go) and can provide additional power (Lock Kick) to close and latch the door.

ON BOARD POWER

Power connected devices, sensors, and lights with on-board 24V power.

BUILT-TOUGH

Fire-rated and designed for heavy use, backed by a two-year warranty.

SPECIFICATIONS

- Certifications**
- Conforms to ANSI/BHMA A156.19 for low energy door operators
 - cULus listed; conforms to UL 325, UL 228, UL10C (3hr) and CSA Std.C22.2.#247
 - ADA Compliant

- Type**
- Commercial low energy automatic swing door operator with integrated logic board

- Handing**
- Handed, field reversible¹
 - Field reversible swing (push to pull or vice versa)²

(1) Operators are delivered Right Hand by default
 (2) Included arm converts between «pull» and «push»

- Capacity**
- 480lbs (217kg) per door leaf
 - 48" (122 cm) maximum door leaf width

Based on prevailing conditions at door opening.

- Control Type**
- Microprocessor with digital display

- Opening**
- 120° maximum

- Reveal**
- Up to 12" (304.8mm) for PUSH applications
 - Up to 6" (152.4mm) for PULL applications

- Finish** 628–Anodized aluminum, 711–Anodized Black
 Other finishes available by special order

- Electronic Features**
- One-touch, self-learning, auto-configuration setup
 - Interfaces with access control devices
 - Works with all major sensors, including BEA LZR and Optex Elite Pro
 - Operates as mechanical closer during power failures
 - Dual operators can operate independently (Dual-Egress) or simultaneously
 - Power Assist (Push&Go) for automatic door opening when pushed
 - Lock Retry and Lock Kick to ensure proper latching
 - Wind Force Dampening (Wind-Brake) to counteract wind forces
 - Pressure Compensation to counteract positive, negative and sudden pressure changes for smooth operation
 - Built-in encoders track door position, even after a power failure
 - Built-in obstacle detection, expandable with sensors (sold separately)
 - Mechanical door stop (80° to 120°)
 - Programmable sweep and latching speeds
 - Programmable cushioning backcheck
 - Programmable delayed action

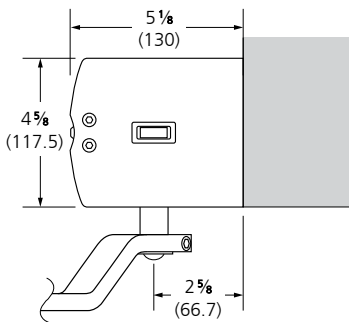

TECHNICAL DATA

Electrical

- Power supply: 115V AC, 60HZ
- Power consumption: Max. 100W, draws 500mA
- Auxiliary output voltage: 24 VDC up to 1A
- Fuse type: 5A @ 500V, Slow-Blow
- Electric lock relay type: MOSFET
- Lock relay rating: 5.7A @ 100VDC (limited to 1.1A @ 24VDC)

Motor

- Rating: 18VDC
- Type: Permanent Magnet (PM) Silent

Environmental

- Operating temp. : -40° to 50°C (-40° to 122°F)
- Relative humidity: Max. 100%

SELECTION GUIDE

MODEL	DESCRIPTION	HANDING / OPERATION	LENGTH*	FINISH*
FOR STANDARD SWING DOORS		REVERSIBLE HANDING / REVERSIBLE OPERATION		
300	Surface mounted, single operator	LEFT HAND-L (PULL-PL) / RIGHT HAND-R (PULL-PL)	41 (1041.4)	Clear (628)
320	Surface mounted, paired operators, simultaneous one-direction opening <i>Dual Egress (opposing swings) available - indicate DE when ordering.</i>		76 (1930.4)	
350	Surface mounted, single operator paired with surface door closer mounting plate (door closer sold separately) ¹	RIGHT HAND-R (PUSH-PS) / LEFT HAND-L (PUSH-PS)		Anodized Black (711)

IN (MM) (*) CUSTOM HEADER LENGTHS AND OTHER FINISHES AVAILABLE BY SPECIAL ORDER. (1) DOREX 441HD SURFACE DOOR CLOSER RECOMMENDED.
 NOTE: CONCEALED, PIVOT AND SWING-CLEAR MODELS ARE AVAILABLE BY SPECIAL ORDER.

ALL MODELS INCLUDE All SA-300 swing door operators have a clutch-less gear box and a push/pull arm that allows the operator to drive the door in either direction. Ideal for heavy over-sized doors or high stack pressure or heavy wind conditions.

TO ORDER

SA - 300 - 41 - 628
 MODEL LENGTH FINISH

DELIVERED RIGHT HAND WITH PUSH/PULL ARM BY DEFAULT. FIELD REVERSIBLE.

For more information about the SA-300, similar and complimentary products, please contact your local Canaropa sales representative.

PARTS



SA-PSN/PLN PUSH/PULL ARM ASSEMBLY

- Convertable from push arm to pull arm
- Heavy-duty, cast alloy construction
- Available in dark bronze (668)

COMPLEMENTARY ACCESSORIES



CX-ED1379 NARROW STILE ELECTRIC STRIKE

- For cylindrical and mortise locksets with spring latches
- Selectable Fail Safe/Fail Secure
- Selectable 12/24V, AC/DC
- ½ to ¾" (12.7 – 16 mm) latch projection
- Easy fit connectors
- A range of aluminum and dark bronze face plates



HOLLOW METAL WOOD ALUMINUM



CM-RQE7A



CM-RQE7ABK

CM-RQE70A

PIR "REQUEST TO EXIT" SENSOR:

- Compact design for door frames
- Easy to use on-board programming
- (4) Factory default operating modes, with the ability to customize mode attributes
- Selectable fail safe/fail secure
- (2) Form 'C' contacts
- Momentary and latching relay modes
- Secondary activation device input
- Card/keypad input
- Door position switch input
- Request to Exit input
- Built-in sounder (adjustable)
- Tamper switch



CM-400

PUSH BUTTON STAINLESS STEEL FACEPLATE:

- 1 ¾" (40 mm) diameter button
- Vandal resistant free-spinning button
- Single gang stainless steel face plate
- Available in English or French



CM-45

4 ½ x 4 ½ in (114 x 114 mm) PUSHPLATE:

- ADA Compliant
- Hidden mounting screws
- Stainless steel push plate
- Available in English or French

Mounting boxes are not included.



CX-WEC10K2

EMERGENCY CALL KIT FOR UNIVERSAL RESTROOMS:

- Complete kit
- Double gang, emergency call button with annunciator
- Single gang dome light with alarm
- Solid white sign (English / French)

Mounting boxes are not included.



CM-AF500

LED ANNUNCIATORS:

- Bright LEDs for high visibility, even in daylight
- Text/graphics are not legible when not illuminated
- Vandal and weather resistant construction
- Single gang stainless steel face plate



CM-30C

SQUARE ILLUMINATED EXIT SWITCH:

- High visibility 2" (51 mm) square button
- Single gang with stainless steel faceplate
- Bright LED provides clarity and longevity
- Variety of bilingual labels



National Guard Products (NGP) specializes in manufacturing and distributing high-quality weather-stripping, door sweeps, thresholds, perimeter seals, and more. Products designed to meet the needs of commercial and institutional building projects to improve energy efficiency, provide soundproofing and enhance security.

www.ngp.com



AUTOMATIC DOOR BOTTOMS



220NA-36

NEOPRENE - 36 in

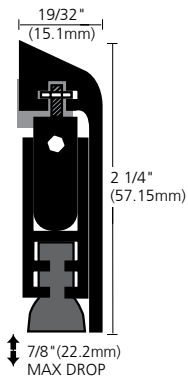

335N-36

NEOPRENE - 36 in

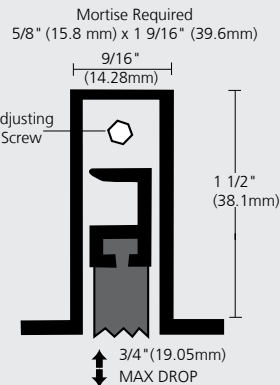

320V-36

MILL ALUMINUM WITH VINYL SEAL - 36 in

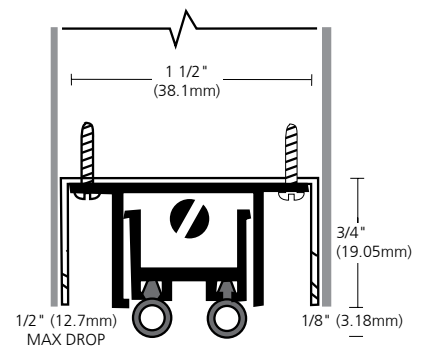

DOOR SEALS



5050B-17
GASKET

BROWN GASKET - 17 ft

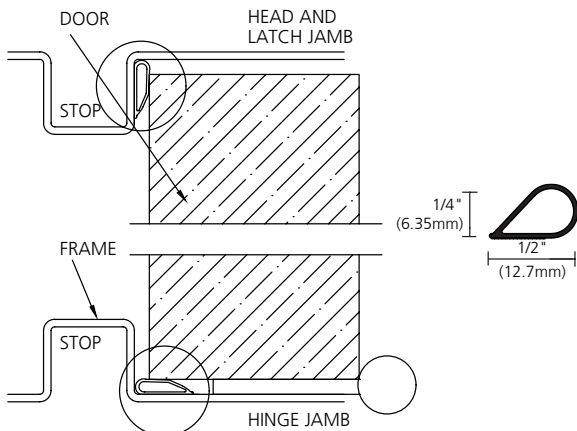

155V-17
PERIMETER SEAL

MILL ALUMINUM WITH VINYL SEAL - 17 ft

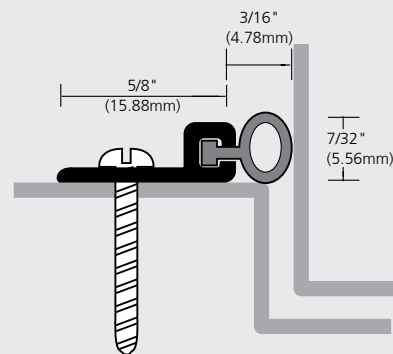

DOOR SWEEPS



200NA-36

ANODIZED ALUMINUM NEOPRENE - 36 in

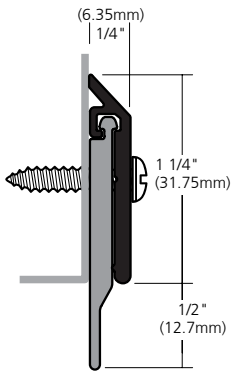

601A-36

ANODIZED ALUMINUM - 36 in

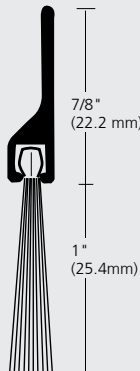

C627A-36

ANODIZED ALUMINUM - 36 in

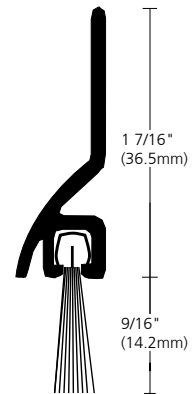

OVERLAPPING ASTRAGALS



158NA-7

ANODIZED ALUMINUM WITH NGP TPV SEAL - 7 ft

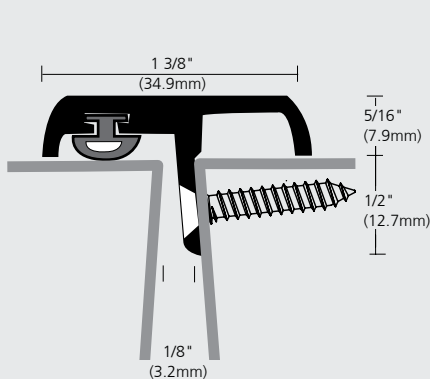

THERMAL BREAK SADDLE THRESHOLDS



8425-36

8425-36 MILL ALUMINUM - 36 in
8435V-36 SILICONE - 36 in

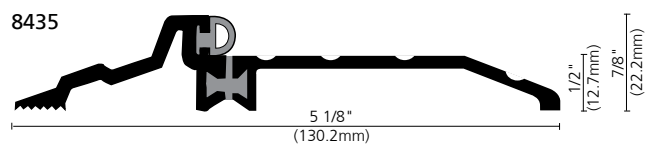
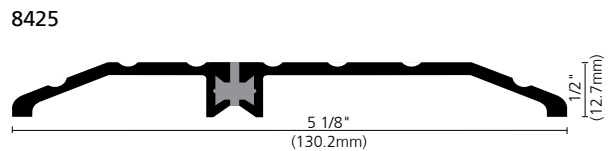

Looking for more NGP products?

Discover the full range of National Guard Products (NGP) and delve deeper into their offerings by visiting

www.ngp.com

OFFICIAL DISTRIBUTOR.

All National Guard Products (NGP) products are available through Canaropa.

Please contact your local Canaropa sales representative to order – special orders may require additional delivery time and/or minimum order quantities.



CERTIFIED by UL to CAN/ULC-S104 and ANSI/UL10B, complies with NFPA 80 and NFPA 252 for application to Hollow Metal fire doors rated up to 3 Hrs., and Wood fire doors rated up to 90 minutes.



POSITIVE PRESSURE - CERTIFIED by UL to ANSI/UL10C, complies with IBC, NFPA 80 and NFPA 252 for application to Hollow Metal fire doors rated up to 3 Hrs., and Wood fire doors rated up to 90 minutes.



SMOKE & DRAFT CONTROL GASKETING. Certified by UL to ANSI/UL10C and ANSI/UL1784 Category 'H'; complies with IBC and NFPA 105 for use on 'S' labeled Positive Pressure Hollow Metal fire doors rated up to 3 hours, and Wood fire doors rated up to 90 minutes.



AIR INFILTRATION TESTED to ASTM E283, Standard Test Method for Determining Rate of Air Leakage Through Exterior Windows, Curtain Walls, and Doors.



ACOUSTICAL TESTED to ASTM E90 Standard Test Method for Laboratory Measurement of Airborne Sound Transmission Loss of Building Partitions and Elements, and ASTM E2235 Standard Test Method for Determination of Decay Rates for use in Sound Insulation Test Methods. Refer to information on pages G4 and G5 of our Gasketing catalogue for test result data.



SMOKE & DRAFT CONTROL GASKETING. Door Sweep Application only. Certified by UL to ANSI/UL10C and ANSI/UL1784 Category 'H'; complies with IBC and NFPA 105 for use on 'S' labeled Positive Pressure Hollow Metal fire doors rated up to 3 hours, and Wood fire doors rated up to 90 minutes.



NGP-EDGE® SEALING SYSTEM. Certified by UL to ANSI/UL10C Category 'G'; required for Category B wood fire doors to meet positive pressure requirements complying with IBC, and NFPA 252. See individual products for maximum door size and ratings.



ADA COMPLIANT. Barrier Free Thresholds meet the requirements of the ADA Standard for Accessible Design and ICC/ANSI A117.1 Accessible and Usable Buildings and Facilities.



ANSI/BHMA CERTIFIED. Certified thresholds comply with American National Standard for Thresholds ANSI/BHMA A156.21 1,000 lb. load test and are listed in the BHMA Certified Products Directory.





Perko concealed door closers have been closing doors in a wide variety of commercial, residential, and institutional buildings for over 30 years, establishing themselves as the preferred choice for specifiers and contractors.

www.perkopower.com

PERKO

PERKO

Perko

- The original Perko concealed door closer
- Non-handed
- Solid brass anchor plates
- Adjustable spring mechanism
- For interior doors up to 110lbs (50kg)
- Various finishes available on special order

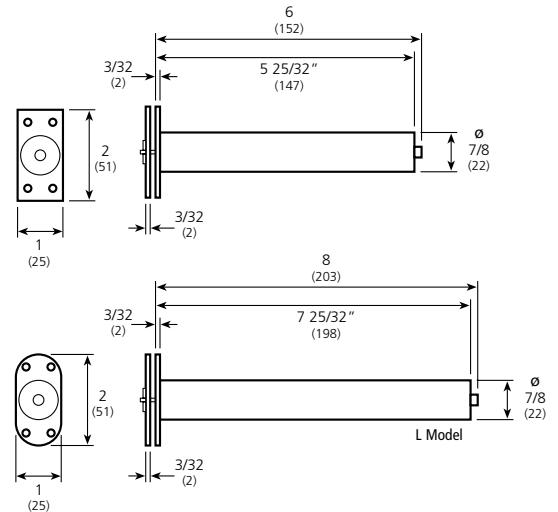

Perkomatic

- Non-handed
- Solid brass anchor plates
- Adjustable spring and hydraulic mechanism
- For interior doors up to 165 lbs (75kg)
- Various finishes available on special order

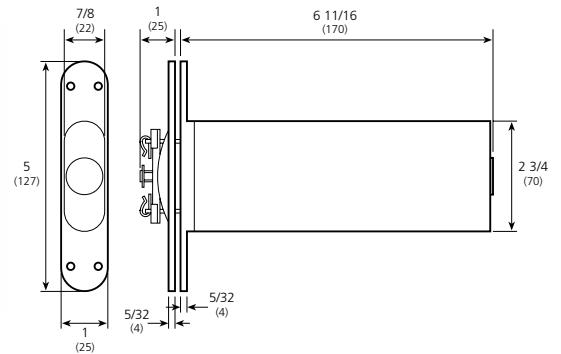

Perkpower

- Fits 1 1/4 to 1 3/4" (31.8 to 44.5mm) door thicknesses
- For doors up to 176lbs (80kg) in weight and 37 1/2" (950mm) wide
- Conforms to ANSI 156.4 and ADA maximum opening force
- Conforms to power size 3 on controlled door closing device
- Suitable for latched and unlatched installations
- Adjustable closing speed and latching action
- Endurance tested to 500,000 closing cycles
- Unique twin power mechanism for extra closing force
- Various finishes available on special order

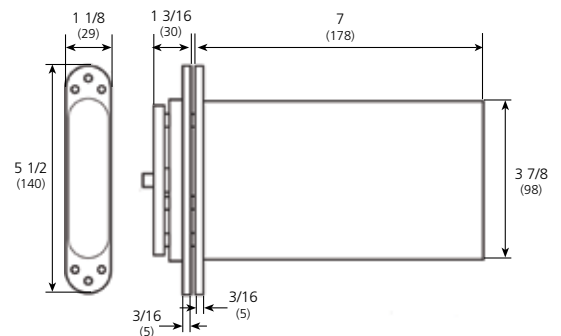

Learn more at: www.perkopower.com

Please contact your local Canaropa sales representative to order. Special orders may require additional delivery time and/or minimum order quantities.



SOSS offers a unique range of products, from their famous invisible hinges to their unique Ultralatch® push-pull door latch. SOSS products can be installed in wood, metal and plastic doors and are used in a wide variety of applications from windows, cabinets, and partitions to office, commercial, and medical applications.

www.soss.com

SOSS

Invisible Hinges



- For wood and metal doors
- Cannot be seen or tampered with when closed
- Available in a wide range of sizes
- Smooth operation
- Fire rated models available
- Power transfer hinge model available
- Available in a variety of finishes



Ultralatch® Push/Pull Lockset



- Single acting, Grade 1 push/pull latch
- Meets ADA requirements
- For doors 1 3/8" (35 mm); 1 3/4" (44.5 mm); 2" (50 mm) thick
- 2 3/8" (60 mm) or 2 3/4" (70 mm) backset
- Privacy, passage, and dummy functions available
- Available in a variety of finishes



Invisible Spring Door Closer



- For light to heavy wood doors
- Cannot be seen or tampered with when closed
- Adjustable closure speed
- Opens 180°
- Available in a variety of finishes



Other Product



BARREL HINGES



MAGNETIC DOOR
HOLDERS AND STOPS

- Wide variety of invisible hinges
- Specialty hinges
- **And more**

Learn more at: www.soss.com

Please contact your local Canaropa sales representative to order. Special orders may require additional delivery time and/or minimum order quantities.



Since 1942, the Viro brand has become synonymous with quality security hardware all over the world. Viro offers a wide range of security and door products to satisfy many different applications.

www.viro.it

Viro

PROPERTY SECURITY



Protect them with VAN LOCK

- Patented, hardened shape prevents gripping and smashing attacks.
- Stainless steel construction prevents corrosion.
- Emergency unlocking from inside prevents accidental lock-in.
- Installs on any door, regardless of misalignment.



Heavy Duty Armoured Padlocks

PANZER



1000 SERIES

Cabinet Locks



MARINE

BRASS

Quality Keyable Padlocks



V06 DEADBOLT

Electrified Gate / Garage Door Locks and Strikes



9083 LOCK

DOOR SECURITY

Forced Entry Protection



SPRANGA LOCKING BAR



7400 SERIES MORTISE LOCKS FOR CONVENTIONAL DOORS



8500 SERIES MORTISE LOCKS FOR METAL FRAME DOORS



CONVENTIONAL & HIGH SECURITY PROFILE CYLINDERS

Bicycle, Scooter and Motorcycle Security



BLACK MAMABA BURGLAR LOCK



SHARK DISC LOCKS



BLOCCA CATENA CHAIN & PADLOCK

**Disc Locks
Burglar Locks
Cable Locks
U-Locks
Chains & Padlocks**

Learn more at: www.viro.it

Please contact your local Canaropa sales representative to order. Special orders may require additional delivery time and/or minimum order quantities.