Glass Door Configurations



DOOR CONFIGURATION TABLE OF CONTENTS

Single Door Configurations

Complete Glass Door Closer Kit	4
Single Door (SD).....	5
Single Door with Transom (SDT).....	6
Single Door + Single Sidelight Left (SDSSL)	7
Single Door + Single Sidelight Right (SDSSR)	8
Single Door + Double Sidelight (SDDS).....	9
Single Door with Transom + Single Sidelight Right (SDTSR)	10
Single Door with Transom + Single Sidelight Left (SDTSSL)	11
Single Door with Transom + Double Sidelight (SDTDS)	12

Double Door Configurations

Double Doors (DD).....	14
Double Doors with Transom (DDT)	15
Double Doors + Single Sidelight Left (DDSSL)	16
Double Doors + Single Sidelight Right (DDSSR).....	17
Double Doors + Double Sidelight (DDDS)	18
Double Doors with Transom + Single Sidelight Right (DDTSSR).....	19
Double Doors with Transom + Single Sidelight Left (DDTSSL)	20
Double Doors with Transom + Double Sidelight (DDTDS)	21
Architectural Lever Styles	22

Single Door Configurations



Complete Glass Door Closer Kit



- Includes all parts required for a single glass door*
- For interior use in low to moderate traffic applications
- For tempered glass panels $\frac{5}{16}$ – $\frac{1}{2}$ " (8-12 mm) thick

Includes:



Top Frame Pivot (PF120TP)

- Solid steel
- Surface mounted



Top Door Patch Fitting Pivot (PF121)

- Machined aluminum body
- Metal covers

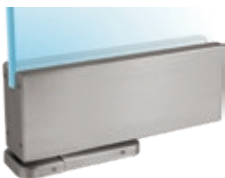

Hydraulic Patch Fitting Door Closer (PF100DC)

- Concealed in patch fitting
- Single or double acting
- +/- 150° maximum opening
- Adjustable closing and latching speed
- Floor surface mounted
- Pinned metal covers
- Available with 90° hold open, PF100DCHO

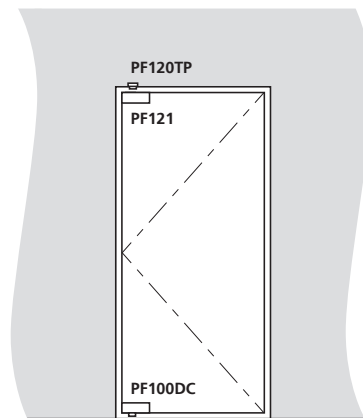

To order:



Clear Anodized Aluminum

PF100DC-SD3-628 (No hold open)
PF100DCHO-SD3-628 (90° hold open)



Polished Stainless Steel

PF100DCHO-SD3-629 (90° hold open)



Satin Stainless Steel

PF100DC-SD3-630 (No hold open)
PF100DCHO-SD3-630 (90° hold open)



Matte Black Coated Steel

PF100DC-SD3-19 (No hold open)
PF100DCHO-SD3-19 (90° hold open)

* Door pull or lock not included

SD-1A

Basic **with pulls**, + concealed floor closer

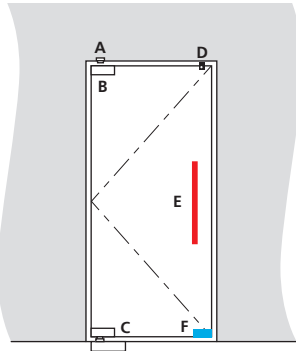

- A PF120TP1 (1x) Top pivot, fixed or PF120TP2 (1x) Walking pivot
- B PF120 (1x) Top door patch fitting
- C PF110 (1x) Bottom door patch + Dorex 40 (1x)
- D PF165CM (1x) Door stop
- E 18R/Q/T (1x) Mitered Door Pulls
19R/Q (1x) Ladder Door Pulls
20R/Q (1x) Offset Door Pulls



- F PF180 (1x) Floor deadbolt
PF181 (1x) Floor deadbolt

SD-1B

Basic **with door lock**, with or without concealed floor closer

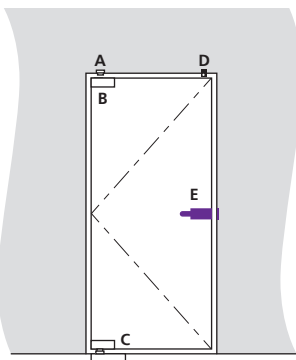

- A PF120TP1 (1x) Top pivot, fixed or PF120TP2 (1x) Walking pivot
- B PF120 (1x) Top door patch fitting
- C PF110 (1x) Bottom door patch + Dorex 40 (1x)
- D PF165CM (1x) Door stop
- E* PF210 (1x) Passage Lock + ASAC15, LSO1 Strikes
PF251 (1x) Entry Lock (KIK) + ASAC15, LSO1 Strikes
PF251p (1x) entry lock (Profile) + ASAC15, LSO1 Strikes

SD-2A

Top closer **with pulls**, + overhead concealed door closer

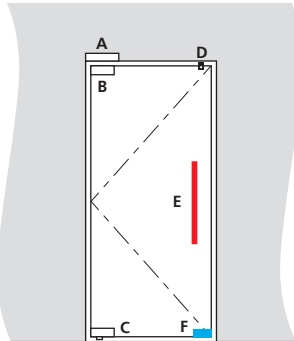

- A DOREX 30 (1x) Transom door closer
- B PF150 (1x) Top door patch fitting
- C PF110 (1x) Bottom door patch fitting + PF110BP1 Floor pivot
- D PF165CM (1x) Door stop
- E 18R/Q/T (1x) Mitered Door Pulls
19R/Q (1x) Ladder Door Pulls
20R/Q (1x) Offset Door Pulls



- F PF180 (1x) Floor deadbolt
PF181 (1x) Floor deadbolt

SD-2B

Top closer **with door lock**, with or without overhead concealed door closer

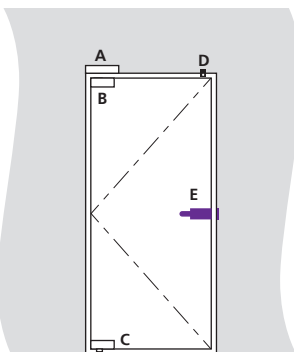

- A DOREX 30 (1x) Transom door closer
- B PF150 (1x) Top door patch fitting
- C PF110 (1x) Bottom door patch fitting + PF110BP1 Floor pivot
- D PF165CM (1x) Door stop
- E* PF210 (1x) Passage Lock + ASAC15, LSO1 Strikes
PF251 (1x) Entry Lock (KIK) + ASAC15, LSO1 Strikes
PF251p (1x) Entry lock (Profile) + ASAC15, LSO1 Strikes

SD-3A

Hydraulic patch fitting closer **with pulls**

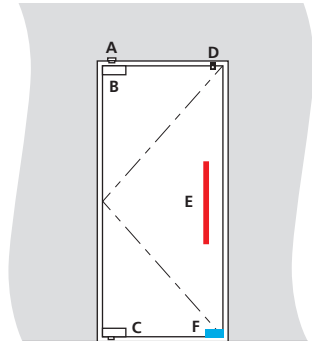

- A PF120TP1 (1x) Top pivot, fixed or PF120TP2 (1x) Walking pivot
- B PF121 (1x) Top door patch fitting
- C PF100DC / PF102DC (1x) Hydraulic patch fitting closer or PF100DCHO / PF102DCHO (1x) Hydraulic patch fitting closer, hold open
- D PF165CM (1x) Door stop
- E 18R/Q/T (1x) Mitered Door Pulls
19R/Q (1x) Ladder Door Pulls
20R/Q (1x) Offset Door Pulls



- F PF180 (1x) Floor deadbolt
PF181 (1x) Floor deadbolt

SD-3B

Hydraulic patch fitting closer **with door lock**

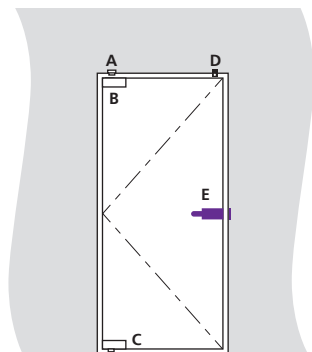

- A PF120TP1 (1x) Top pivot, fixed or PF120TP2 (1x) Walking pivot
- B PF121 (1x) Top door patch fitting
- C PF100DC / PF102DC (1x) Hydraulic patch fitting closer or PF100DCHO / PF102DCHO (1x) Hydraulic patch fitting closer, hold open
- D PF165CM (1x) Door stop
- E* PF210 (1x) Passage Lock + ASAC15, LSO1 Strikes
PF251 (1x) Entry Lock (KIK) + ASAC15, LSO1 Strikes
PF251p (1x) Entry lock (Profile) + ASAC15, LSO1 Strikes

*Lever styles sold separately. See page 22.

SINGLE DOOR WITH TRANSOM (SDT)

SDT-1A

Basic **with pulls**, + concealed floor closer

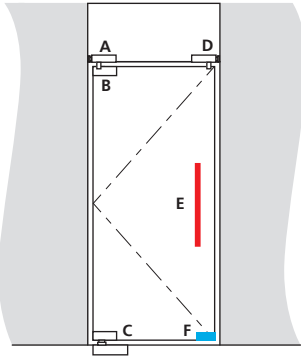

- A **PF130** (1x) Transom patch fitting with pivot
- B **PF120** 1x) Top door patch fitting
- C **PF110** (1x) Bottom door patch fitting + **PF110BP1** Floor pivot or **Dorex 40** (1x)
- D **PF163** (1x) Transom patch with door stop
- E **18R/Q/T** (1x) Mitered Door Pulls
19R/Q (1x) Ladder Door Pulls
20R/Q (1x) Offset Door Pulls



- F **PF180** (1x) Floor deadbolt
PF181 (1x) Floor deadbolt

SDT-1B

Basic **with door lock**, + concealed floor closer

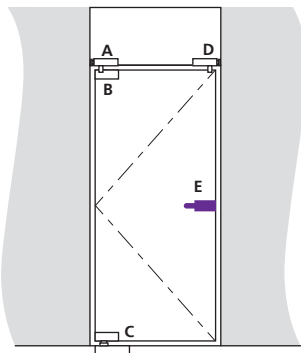

- A **PF130** (1x) Transom patch fitting with pivot
- B **PF120** 1x) Top door patch fitting
- C **PF110** (1x) Bottom door patch fitting + **Dorex 40** (1x)
- D **PF163** (1x) Transom patch with door stop
- E* **PF210** (1x) Passage Lock + **ASAC15, LSO1** Strikes
PF251 (1x) Entry Lock (KIK) + **ASAC15, LSO1** Strikes
PF251p (1x) entry lock (Profile) + **ASAC15, LSO1** Strikes

SDT-3A

Hydraulic patch fitting closer **with pulls**

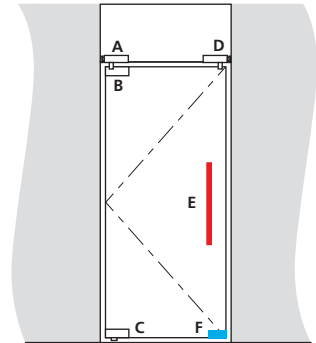

- A **PF131** (1x) Transom patch fitting with pivot
- B **PF121** (1x) Top pivot
- C **PF100DC / PF102DC** (1x) Hydraulic patch fitting closer or **PF100DCHO / PF102DCHO** (1x) Hydraulic patch fitting closer, hold open
- D **PF164** (1x) Transom patch with door stop
- E **18R/Q/T** (1x) Mitered Door Pulls
19R/Q (1x) Ladder Door Pulls
20R/Q (1x) Offset Door Pulls



- F **PF180** (1x) Floor deadbolt
PF181 (1x) Floor deadbolt

SDT-3B

Hydraulic patch fitting closer **with door lock**

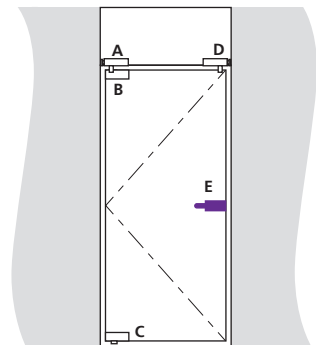

- A **PF131** (1x) Transom patch fitting with pivot
- B **PF121** (1x) Top pivot
- C **PF100DC / PF102DC** (1x) Hydraulic patch fitting closer or **PF100DCHO / PF102DCHO** (1x) Hydraulic patch fitting closer, hold open
- D **PF164** (1x) Transom patch with door stop
- E* **PF210** (1x) Passage Lock + **ASAC15, LSO1** Strikes
PF251 (1x) Entry Lock (KIK) + **ASAC15, LSO1** Strikes
PF251p (1x) entry lock (Profile) + **ASAC15, LSO1** Strikes

SDSSL-1A

Basic **with pulls**, + concealed floor closer

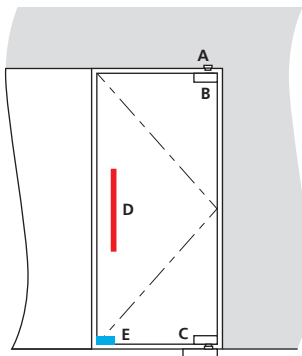

- A **PF120TP1** (1x) Top pivot, fixed or **PF120TP2** (1x) Walking pivot
- B **PF120** (1x) Top door patch fitting
- C **PF110** (1x) Bottom door patch + **Dorex 40** (1x)
- D **18R/Q/T** (1x) Mitered Door Pulls
19R/Q (1x) Ladder Door Pulls
20R/Q (1x) Offset Door Pulls



- E **PF180** (1x) Floor deadbolt
PF181 (1x) Floor deadbolt

SDSSL-2A

Top closer **with pulls**, + overhead concealed door closer

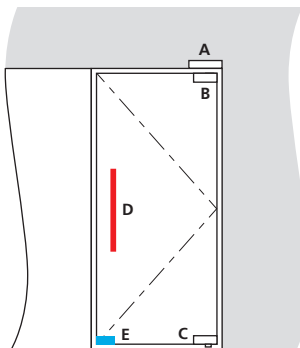

- A **DOREX 30** (1x) Transom door closer
- B **PF150** (1x) Top door patch fitting
- C **PF110** (1x) Bottom door patch fitting
- D **18R/Q/T** (1x) Mitered Door Pulls
19R/Q (1x) Ladder Door Pulls
20R/Q (1x) Offset Door Pulls



- E **PF180** (1x) Floor deadbolt
PF181 (1x) Floor deadbolt

SDSSL-3A

Hydraulic patch fitting closer **with pulls**

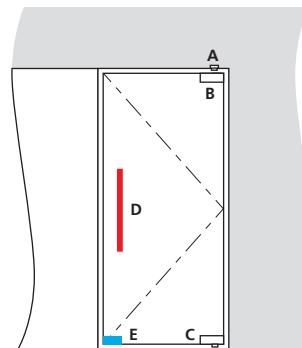

- A **PF120TP1** (1x) Top pivot, fixed or **PF120TP2** (1x) Walking pivot
- B **PF121** (1x) Top door patch fitting
- C **PF100DC / PF102DC** (1x) Hydraulic patch fitting closer or **PF100DCHO / PF102DCHO** (1x) Hydraulic patch fitting closer, hold open
- D **18R/Q/T** (1x) Mitered Door Pulls
19R/Q (1x) Ladder Door Pulls
20R/Q (1x) Offset Door Pulls



- E **PF180** (1x) Floor deadbolt
PF181 (1x) Floor deadbolt

SDSSL-1B

Basic **with door lock**, + concealed floor closer

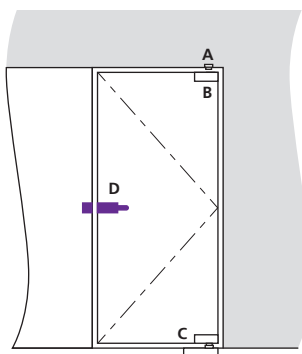

- A **PF120TP1** (1x) Top pivot, fixed or **PF120TP2** (1x) Walking pivot
- B **PF120** (1x) Top door patch fitting
- C **PF110** (1x) Bottom door patch fitting + **Dorex 40** (1x)
- D* **PF210** (1x) Passage Lock + **PF200** (1x) Strike
PF251 (1x) Entry Lock (KIK) + **PF200** (1x) Strike
PF251P (1x) Entry lock (Profile) + **PF200** (1x) Strike

SDSSL-2B

Top closer **with door lock**, + overhead concealed door closer

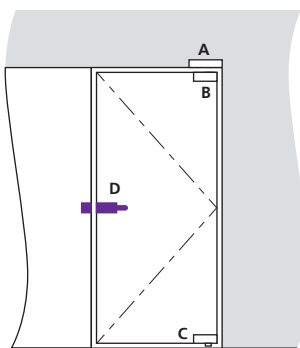

- A **DOREX 30** (1x) Transom door closer
- B **PF150** (1x) Top door patch fitting
- C **PF110** (1x) Bottom door patch fitting + **PF110BP1** Floor pivot
- D* **PF210** (1x) Passage Lock + **PF200** (1x) Strike
PF251 (1x) Entry Lock (KIK) + **PF200** (1x) Strike
PF251P (1x) Entry lock (Profile) + **PF200** (1x) Strike

SDSSL-3B

Hydraulic patch fitting closer **with door lock**

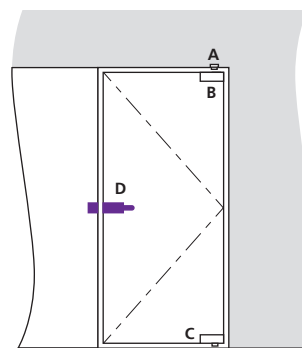

- A **PF120TP1** (1x) Top pivot, fixed or **PF120TP2** (1x) Walking pivot
- B **PF121** (1x) Top door patch fitting
- C **PF100DC / PF102DC** (1x) Hydraulic patch fitting closer or **PF100DCHO / PF102DCHO** (1x) Hydraulic patch fitting closer, hold open
- D* **PF210** (1x) Passage Lock + **PF200** (1x) Strike
PF251 (1x) Entry Lock (KIK) + **PF200** (1x) Strike
PF251P (1x) Entry lock (Profile) + **PF200** (1x) Strike

SINGLE DOOR + SINGLE SIDELIGHT RIGHT (SDSSR)

SDSSR-1A

Basic **with pulls**, + concealed floor closer

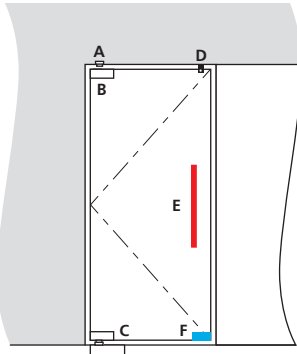

- A PF120TP1 (1x) Top pivot, fixed or PF120TP2 (1x) Walking pivot
- B PF120 (1x) Top door patch fitting
- C PF110 (1x) Bottom door patch fitting + Dorex 40 (1x)
- D PF165CM (1x) Door stop
- E 18R/Q/T (1x) Mitered Door Pulls
19R/Q (1x) Ladder Door Pulls
20R/Q (1x) Offset Door Pulls



- F PF180 (1x) Floor deadbolt
PF181 (1x) Floor deadbolt

SDSSR-1B

Basic **with door lock**, + concealed floor closer

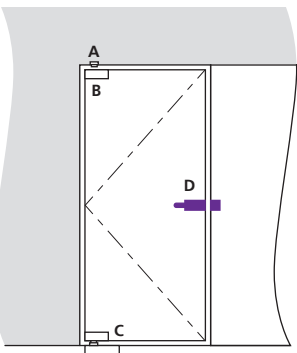

- A PF120TP1 (1x) Top pivot, fixed or PF120TP2 (1x) Walking pivot
- B PF120 (1x) Top door patch fitting
- C PF110 (1x) Bottom door patch fitting + Dorex 40 (1x)
- D* PF210 (1x) Passage Lock + PF200 (1x) Strike
PF251 (1x) Entry Lock (KIK) + PF200 (1x) Strike
PF251P (1x) Entry lock (Profile) + PF200 (1x) Strike

SDSSR-2A

Top closer **with pulls**, + overhead concealed door closer

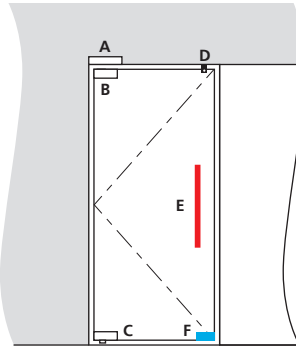

- A DOREX 30 (1x) Transom door closer
- B PF150 (1x) Top door patch fitting
- C PF110 (1x) Bottom door patch fitting
- D PF165CM (1x) Door stop
- E 18R/Q/T (1x) Mitered Door Pulls
19R/Q (1x) Ladder Door Pulls
20R/Q (1x) Offset Door Pulls



- F PF180 (1x) Floor deadbolt
PF181 (1x) Floor deadbolt

SDSSR-2B

Top closer **with door lock**, + overhead concealed door closer

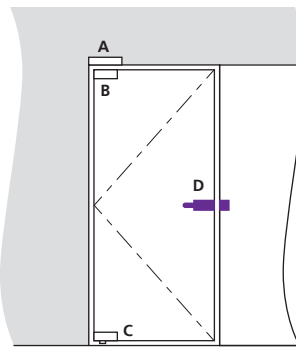

- A DOREX 30 (1x) Transom door closer
- B PF150 (1x) Top door patch fitting
- C PF110 (1x) Bottom door patch fitting
- D* PF210 (1x) Passage Lock + PF200 (1x) Strike
PF251 (1x) Entry Lock (KIK) + PF200 (1x) Strike
PF251P (1x) Entry lock (Profile) + PF200 (1x) Strike

SDSSR-3A

Hydraulic patch fitting closer **with pulls**

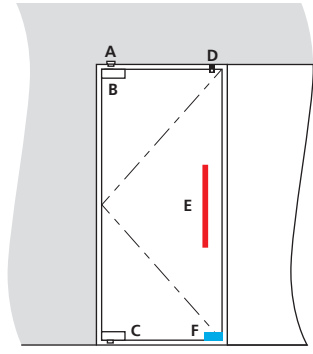

- A PF120TP1 (1x) Top pivot, fixed or PF120TP2 (1x) Walking pivot
- B PF121 (1x) Top door patch fitting
- C PF100DC / PF102DC (1x) Hydraulic patch fitting closer or PF100DCHO / PF102DCHO (1x) Hydraulic patch fitting closer, hold open
- D PF165CM (1x) Door stop
- E 18R/Q/T (1x) Mitered Door Pulls
19R/Q (1x) Ladder Door Pulls
20R/Q (1x) Offset Door Pulls



- F PF180 (1x) Floor deadbolt
PF181 (1x) Floor deadbolt

SDSSR-3B

Hydraulic patch fitting closer **with door lock**

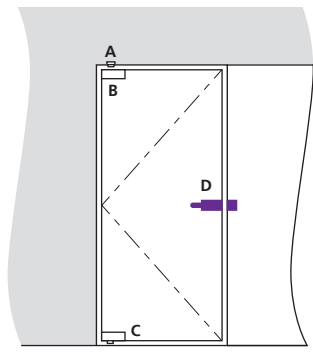

- A PF120TP1 (1x) Top pivot, fixed or PF120TP2 (1x) Walking pivot
- B PF121 (1x) Top door patch fitting
- C PF100DC / PF102DC (1x) Hydraulic patch fitting closer or PF100DCHO / PF102DCHO (1x) Hydraulic patch fitting closer, hold open
- D* PF210 (1x) Passage Lock + PF200 (1x) Strike
PF251 (1x) Entry Lock (KIK) + PF200 (1x) Strike
PF251P (1x) Entry lock (Profile) + PF200 (1x) Strike

SDDS-1A

Basic **with pulls**, + concealed floor closer

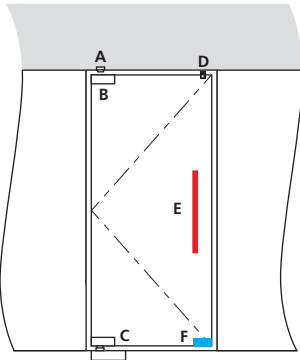

- A PF120TP1 (1x) Top pivot, fixed or PF120TP2 (1x) Walking pivot
- B PF120 (1x) Top door patch fitting
- C PF110 (1x) Bottom door patch fitting + Dorex 40 (1x)
- D PF165CM (1x) Door stop
- E 18R/Q/T (1x) Mitered Door Pulls
19R/Q (1x) Ladder Door Pulls
20R/Q (1x) Offset Door Pulls



- F PF180 (1x) Floor deadbolt
PF181 (1x) Floor deadbolt

SDDS-1B

Basic **with door lock**, + concealed floor closer

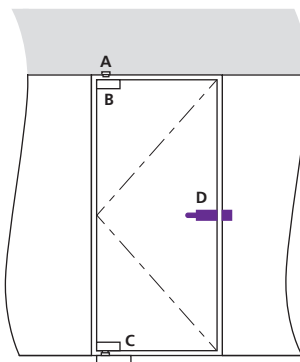

- A PF120TP1 (1x) Top pivot, fixed or PF120TP2 (1x) Walking pivot
- B PF120 (1x) Top door patch fitting
- C PF110 (1x) Bottom door patch fitting + PF110BP1 Floor pivot or Dorex 40 (1x)
- D* PF210 (1x) Passage Lock + PF200 (1x) Strike
PF251 (1x) Entry Lock (KIK) + PF200 (1x) Strike
PF251P (1x) Entry lock (Profile) + PF200 (1x) Strike

SDDS-2A

Top closer **with pulls**, + overhead concealed door closer

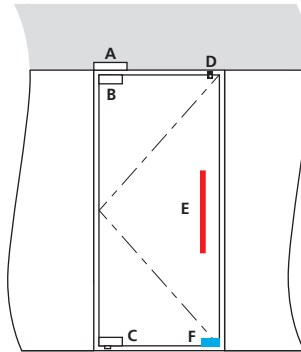

- A DOREX 30 (1x) Transom door closer
- B PF150 (1x) Top door patch fitting
- C PF110 (1x) Bottom door patch fitting
- D PF165CM (1x) Door stop
- E 18R/Q/T (1x) Mitered Door Pulls
19R/Q (1x) Ladder Door Pulls
20R/Q (1x) Offset Door Pulls



- F PF180 (1x) Floor deadbolt
PF181 (1x) Floor deadbolt

SDDS-2B

Top closer **with door lock**, + overhead concealed door closer

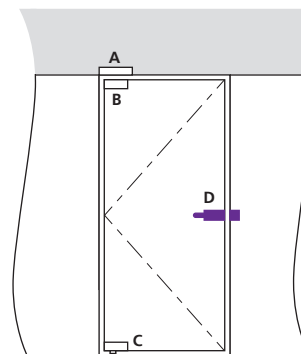

- A DOREX 30 (1x) Transom door closer
- B PF150 (1x) Top door patch fitting
- C PF110 (1x) Bottom door patch fitting + PF110BP1 Floor pivot
- D* PF210 (1x) Passage Lock + PF200 (1x) Strike
PF251 (1x) Entry Lock (KIK) + PF200 (1x) Strike
PF251P (1x) Entry lock (Profile) + PF200 (1x) Strike

SDDS-3A

Hydraulic patch fitting closer **with pulls**

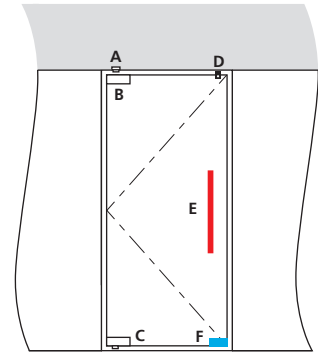

- A PF120TP1 (1x) Top pivot, fixed or PF120TP2 (1x) Walking pivot
- B PF121 (1x) Top door patch fitting
- C PF100DC / PF102DC (1x) Hydraulic patch fitting closer or PF100DCHO / PF102DCHO (1x) Hydraulic patch fitting closer, hold open
- D PF165CM (1x) Door stop
- E 18R/Q/T (1x) Mitered Door Pulls
19R/Q (1x) Ladder Door Pulls
20R/Q (1x) Offset Door Pulls



- F PF180 (1x) Floor deadbolt
PF181 (1x) Floor deadbolt

SDDS-3B

Hydraulic patch fitting closer **with door lock**

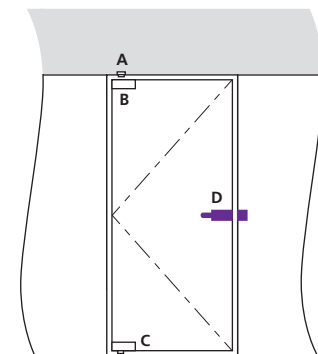

- A PF120TP1 (1x) Top pivot, fixed or PF120TP2 (1x) Walking pivot
- B PF121 (1x) Top door patch fitting
- C PF100DC / PF102DC (1x) Hydraulic patch fitting closer or PF100DCHO / PF102DCHO (1x) Hydraulic patch fitting closer, hold open
- D* PF210 (1x) Passage Lock + PF200 (1x) Strike
PF251 (1x) Entry Lock (KIK) + PF200 (1x) Strike
PF251P (1x) Entry lock (Profile) + PF200 (1x) Strike

SINGLE DOOR WITH TRANSOM + SINGLE SIDELIGHT RIGHT (SDTSR)

SDTSR-1A

Basic **with pulls**, + concealed floor closer

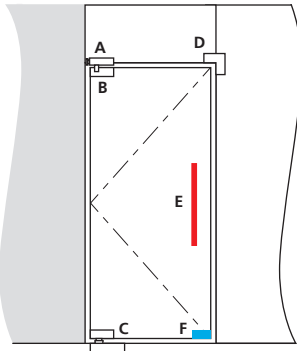

- A **PF130** (1x) Transom patch fitting with pivot
- B **PF120** (1x) Top door patch fitting
- C **PF110** (1x) Bottom door patch fitting + **Dorex 40** (1x)
- D **PF160** (1x) Transom corner stop patch fitting
- E **18R/Q/T** (1x) Mitered Door Pulls
19R/Q (1x) Ladder Door Pulls
20R/Q (1x) Offset Door Pulls



- F **PF180** (1x) Floor deadbolt
PF181 (1x) Floor deadbolt

SDTSR-1B

Basic **with door lock**, + concealed floor closer

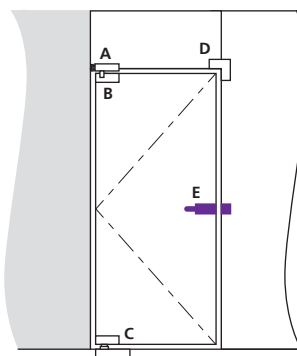

- A **PF130** (1x) Transom patch fitting with pivot
- B **PF120** (1x) Top door patch fitting
- C **PF110** (1x) Bottom door patch fitting + **Dorex 40** (1x)
- D **PF160** (1x) Corner patch fitting with stop
- E* **PF210** (1x) Passage Lock + **PF200** (1x) Strike
PF251 (1x) Entry Lock (KIK) + **PF200** (1x) Strike
PF251P (1x) Entry lock (Profile) + **PF200** (1x) Strike

SDTSR-3A

Hydraulic patch fitting closer **with pulls**

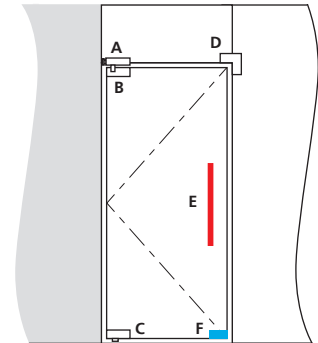

- A **PF131** (1x) Transom patch fitting with pivot
- B **PF121** (1x) Top door patch fitting
- C **PF100DC / PF102DC** (1x) Hydraulic patch fitting closer or **PF100DCHO / PF102DCHO** (1x) Hydraulic patch fitting closer, hold open
- D **PF160** (1x) Transom corner stop patch fitting
- E **18R/Q/T** (1x) Mitered Door Pulls
19R/Q (1x) Ladder Door Pulls
20R/Q (1x) Offset Door Pulls



- F **PF180** (1x) Floor deadbolt
PF181 (1x) Floor deadbolt

SDTSR-3B

Hydraulic patch fitting closer **with door lock**

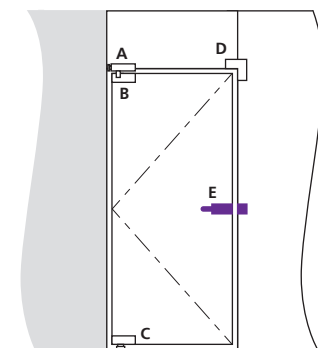

- A **PF131** (1x) Transom patch fitting with pivot
- B **PF121** (1x) Top door patch fitting
- C **PF100DC / PF102DC** (1x) Hydraulic patch fitting closer or **PF100DCHO / PF102DCHO** (1x) Hydraulic patch fitting closer, hold open
- D **PF160** (1x) Corner patch fitting with stop
- E* **PF210** (1x) Passage Lock + **PF200** (1x) Strike
PF251 (1x) Entry Lock (KIK) + **PF200** (1x) Strike
PF251P (1x) Entry lock (Profile) + **PF200** (1x) Strike

SINGLE DOOR WITH TRANSOM + SINGLE SIDELIGHT LEFT (SDTSSL)

SDTSSL-1A

Basic **with pulls**, + concealed floor closer

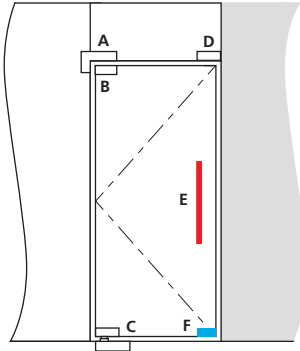

- A **PF140** (1x) Corner patch fitting with stop
- B **PF120** (1x) Top door patch fitting
- C **PF110** (1x) Bottom door patch fitting + **Dorex 40** (1x)
- D **PF163** (1x) Wall mount transom patch fitting with door stop
- E **18R/Q/T** (1x) Mitered Door Pulls
19R/Q (1x) Ladder Door Pulls
20R/Q (1x) Offset Door Pulls



- F **PF180** (1x) Floor deadbolt
PF181 (1x) Floor deadbolt

SDTSSL-1B

Basic **with door lock**, + concealed floor closer

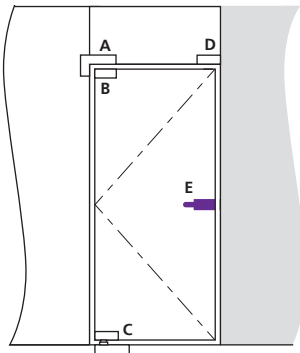

- A **PF140** (1x) Transom patch fitting with pivot
- B **PF120** (1x) Top door patch fitting
- C **PF110** (1x) Bottom door patch fitting + **Dorex 40** (1x)
- D **PF163** (1x) Wall mount transom patch fitting with door stop
- E* **PF210** (1x) Passage Lock + **ASAC15, LSO1** Strikes
PF251 (1x) Entry Lock (KIK) + **ASAC15, LSO1** Strikes
PF251p (1x) entry lock (Profile) + **ASAC15, LSO1** Strikes

SDTSSL-3A

Hydraulic patch fitting closer **with pulls**

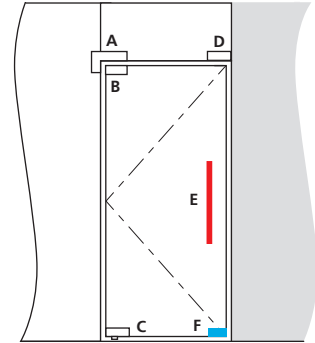

- A **PF140** (1x) Transom corner patch fitting
- B **PF120** (1x) Top door patch fitting
- C **PF100DC / PF102DC** (1x) Hydraulic patch fitting closer or **PF100DCHO / PF102DCHO** (1x) Hydraulic patch fitting closer, hold open
- D **PF164** (1x) Wall mount transom patch fitting with door stop
- E **18R/Q/T** (1x) Mitered Door Pulls
19R/Q (1x) Ladder Door Pulls
20R/Q (1x) Offset Door Pulls



- F **PF180** (1x) Floor deadbolt
PF181 (1x) Floor deadbolt

SDTSSL-3B

Hydraulic patch fitting closer **with door lock**

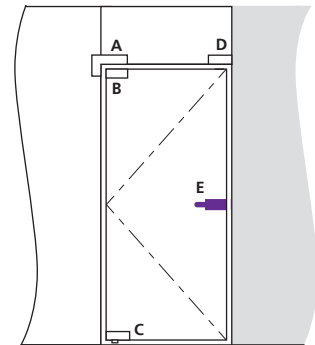

- A **PF140** (1x) Transom corner patch fitting
- B **PF120** (1x) Top door patch fitting
- C **PF100DC / PF102DC** (1x) Hydraulic patch fitting closer or **PF100DCHO / PF102DCHO** (1x) Hydraulic patch fitting closer, hold open
- D **PF164** (1x) Wall mount transom patch fitting with door stop
- E* **PF210** (1x) Passage Lock + **ASAC15, LSO1** Strikes
PF251 (1x) Entry Lock (KIK) + **ASAC15, LSO1** Strikes
PF251p (1x) entry lock (Profile) + **ASAC15, LSO1** Strikes

SINGLE DOOR WITH TRANSOM + DOUBLE SIDELIGHT (SDTDS)

SDTDS-1A

Basic **with pulls**, + concealed floor closer

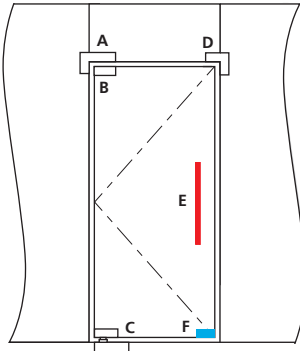

- A **PF140** (1x) Transom corner patch fitting
- B **PF120** (1x) Top door patch fitting
- C **PF110** (1x) Bottom door patch fitting + **Dorex 40** (1x)
- D **PF160** (1x) Corner patch fitting with stop
- E **18R/Q/T** (1x) Mitered Door Pulls
19R/Q (1x) Ladder Door Pulls
20R/Q (1x) Offset Door Pulls



- F **PF180** (1x) Floor deadbolt
PF181 (1x) Floor deadbolt

SDTDS-3A

Hydraulic patch fitting closer **with pulls**

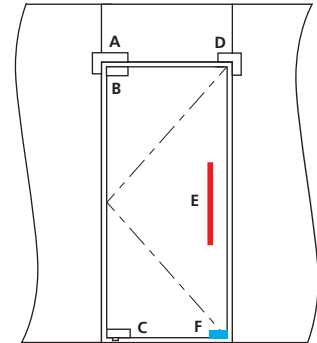

- A **PF140** (1x) Transom corner patch fitting
- B **PF120** (1x) Top door patch fitting
- C **PF100DC / PF102DC** (1x) Hydraulic patch fitting closer or **PF100DCHO / PF102DCHO** (1x) Hydraulic patch fitting closer, hold open
- D **PF160** (1x) Corner patch fitting with stop
- E **18R/Q/T** (1x) Mitered Door Pulls
19R/Q (1x) Ladder Door Pulls
20R/Q (1x) Offset Door Pulls



- F **PF180** (1x) Floor deadbolt
PF181 (1x) Floor deadbolt

SDTDS-1B

Basic **with door lock**, + concealed floor closer

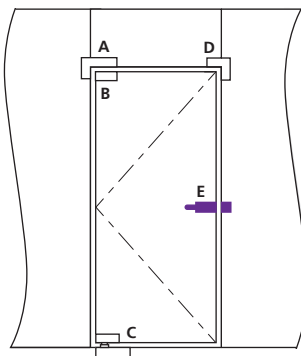

- A **PF140** (1x) Transom corner patch fitting
- B **PF120** (1x) Top door patch fitting
- C **PF110** (1x) Bottom door patch fitting + **Dorex 40** (1x)
- D **PF160** (1x) Corner patch fitting with stop
- E* **PF210** (1x) Passage Lock + **PF200** (1x) Strike
PF251 (1x) Entry Lock (KIK) + **PF200** (1x) Strike
PF251P (1x) Entry lock (Profile) + **PF200** (1x) Strike

SDTDS-3B

Hydraulic patch fitting closer **with door lock**

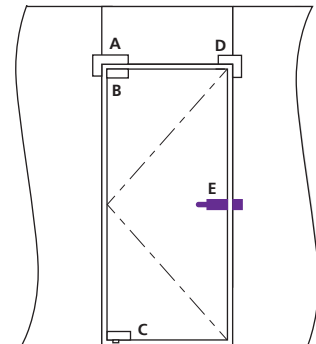

- A **PF140** (1x) Transom corner patch fitting
- B **PF120** (1x) Top door patch fitting
- C **PF100DC / PF102DC** (1x) Hydraulic patch fitting closer or **PF100DCHO / PF102DCHO** (1x) Hydraulic patch fitting closer, hold open
- D **PF160** (1x) Corner patch fitting with stop
- E* **PF210** (1x) Passage Lock + **PF200** (1x) Strike
PF251 (1x) Entry Lock (KIK) + **PF200** (1x) Strike
PF251P (1x) Entry lock (Profile) + **PF200** (1x) Strike

Double Door Configurations



DOUBLE DOORS (DD)

DD-1A

Basic **with pulls**, + concealed floor closer

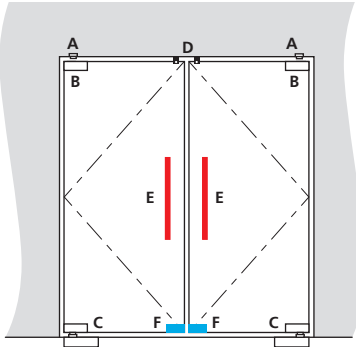

- A PF120TP1 (2x) Top pivot, fixed or PF120TP2 (2x) Walking pivot
- B PF120 (2x) Top door patch fitting
- C PF110 (2x) Bottom door patch fitting + Dorex 40 (2x)
- D PF165CM (2x) Door stop
- E 18R/Q/T (2x) Mitered Door Pulls
19R/Q (2x) Ladder Door Pulls
20R/Q (2x) Offset Door Pulls



- F PF180 (2x) Floor deadbolt
PF181 (2x) Floor deadbolt

DD-1B

Basic **with door lock**, + concealed floor closer

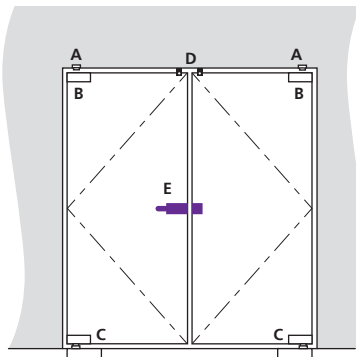

- A PF120TP1 (2x) Top pivot, fixed or PF120TP2 (2x) Walking pivot
- B PF120 (2x) Top door patch fitting
- C PF110 (2x) Bottom door patch fitting + Dorex 40 (2x)
- D PF165CM (2x) Door stop
- E* PF210 (1x) Passage Lock + PF200 (1x) Strike
PF251 (1x) Entry Lock (KIK) + PF200 (1x) Strike
PF251P (1x) Entry lock (Profile) + PF200 (1x) Strike

DD-2A

Top closer **with pulls**, + overhead concealed door closer

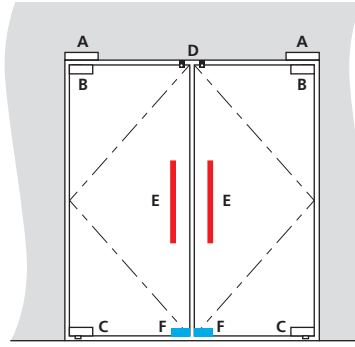

- A DOREX 30 (2x) Transom door closer
- B PF150 (2x) Top door patch fitting
- C PF110 (2x) Bottom door patch fitting + PF110BP1 Floor pivot
- D PF165CM (2x) Door stop
- E 18R/Q/T (2x) Mitered Door Pulls
19R/Q (2x) Ladder Door Pulls
20R/Q (2x) Offset Door Pulls



- F PF180 (2x) Floor deadbolt
PF181 (2x) Floor deadbolt

DD-2B

Top closer **with door lock**, + overhead concealed door closer

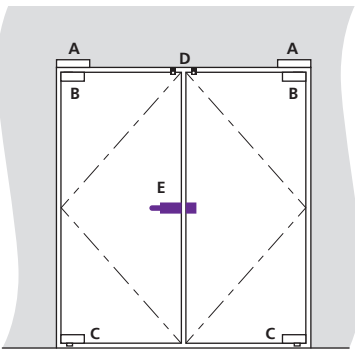

- A DOREX 30 (2x) Transom door closer
- B PF150 (2x) Top door patch fitting
- C PF110 (2x) Bottom door patch fitting + PF110BP1 (2x) Floor pivot
- D PF165CM (2x) Door stop
- E* PF210 (1x) Passage Lock + PF200 (1x) Strike
PF251 (1x) Entry Lock (KIK) + PF200 (1x) Strike
PF251P (1x) Entry lock (Profile) + PF200 (1x) Strike

DD-3A

Hydraulic patch fitting closer **with pulls**

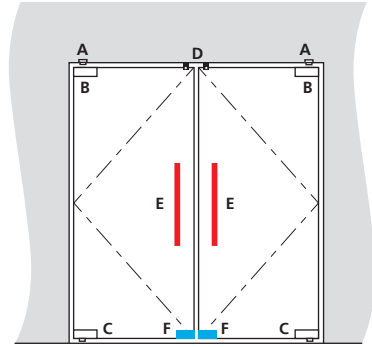

- A PF120TP1 (2x) Top pivot, fixed or PF120TP2 (2x) Walking pivot
- B PF121 (2x) Top door patch fitting
- C PF100DC / PF102DC (2x) Hydraulic patch fitting closer or PF100DCHO / PF102DCHO (2x) Hydraulic patch fitting closer, hold open
- D PF165CM (2x) Door stop
- E 18R/Q/T (2x) Mitered Door Pulls
19R/Q (2x) Ladder Door Pulls
20R/Q (2x) Offset Door Pulls



- F PF180 (2x) Floor deadbolt
PF181 (2x) Floor deadbolt

DD-3B

Hydraulic patch fitting closer **with door lock**

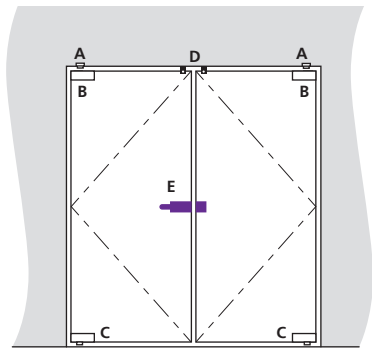

- A PF120TP1 (2x) Top pivot, fixed or PF120TP2 (2x) Walking pivot
- B PF121 (2x) Top door patch fitting
- C PF100DC / PF102DC (2x) Hydraulic patch fitting closer or PF100DCHO / PF102DCHO (2x) Hydraulic patch fitting closer, hold open
- D PF165CM (2x) Door stop
- E* PF210 (1x) Passage Lock + PF200 (1x) Strike
PF251 (1x) Entry Lock (KIK) + PF200 (1x) Strike
PF251P (1x) Entry lock (Profile) + PF200 (1x) Strike

DDT-1A

Basic **with pulls** + concealed floor closer

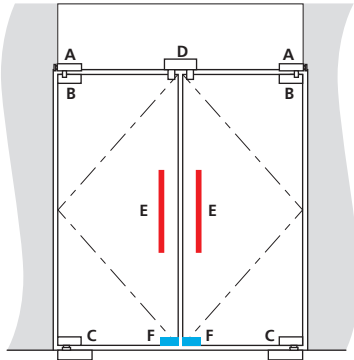

- A PF130 (2x) Transom patch fitting with pivot
- B PF120 (2x) Top door patch fitting
- C PF110 (2x) Bottom door patch fitting + Dorex 40 (2x)
- D PF165 (1x) Transom connector with door stop
- E **18R/Q/T** (2x) Mitered Door Pulls
19R/Q (2x) Ladder Door Pulls
20R/Q (2x) Offset Door Pulls



- F PF180 (2x) Floor deadbolt
PF181 (2x) Floor deadbolt

DDT-1B

Basic **with door lock**, + concealed floor closer

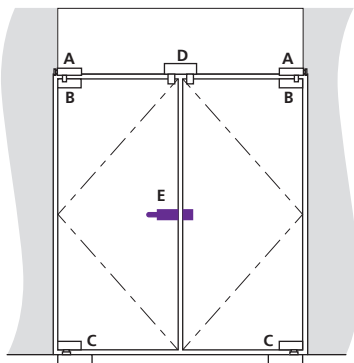

- A PF130 (2x) Transom patch fitting with pivot
- B PF120 (2x) Top door patch fitting
- C PF110 (2x) Bottom door patch fitting + Dorex 40 (2x)
- D PF165 (1x) Transom connector with door stop
- E* PF210 (1x) Passage Lock + PF200 (1x) Strike
PF251 (1x) Entry Lock (KIK) + PF200 (1x) Strike
PF251P (1x) Entry lock (Profile) + PF200 (1x) Strike

DDT-3A

Hydraulic patch fitting closer **with pulls**

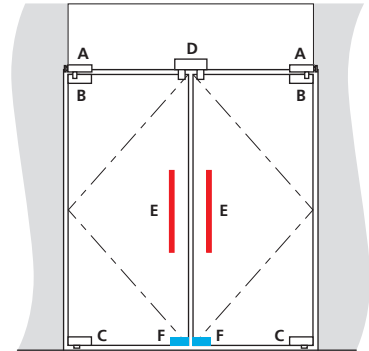

- A PF131 (2x) Transom patch fitting with pivot
- B PF121 (2x) Top pivot
- C PF100DC / PF102DC (2x) Hydraulic patch fitting closer or PF100DCHO / PF102DCHO (2x)
Hydraulic patch fitting closer, hold open
- D PF165 (1x) Transom connector with door stop
- E **18R/Q/T** (2x) Mitered Door Pulls
19R/Q (2x) Ladder Door Pulls
20R/Q (2x) Offset Door Pulls



- F PF180 (2x) Floor deadbolt
PF181 (2x) Floor deadbolt

DDT-3B

Hydraulic patch fitting closer **with door lock**

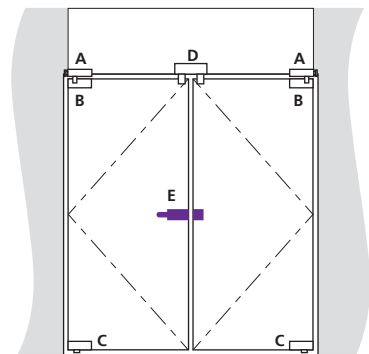

- A PF131 (2x) Transom patch fitting with pivot
- B PF121 (2x) Top pivot
- C PF100DC / PF102DC (2x) Hydraulic patch fitting closer or PF100DCHO / PF102DCHO (2x)
Hydraulic patch fitting closer, hold open
- D PF165 (1x) Transom connector with door stop
- E* PF210 (1x) Passage Lock + PF200 (1x) Strike
PF251 (1x) Entry Lock (KIK) + PF200 (1x) Strike
PF251P (1x) Entry lock (Profile) + PF200 (1x) Strike

DOUBLE DOORS + SINGLE SIDELIGHT LEFT (DDSSL)

DDSSL-1A

Basic **with pulls**, + concealed floor closer

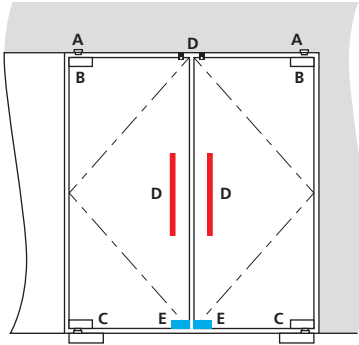

- A PF120TP1 (2x) Top pivot, fixed or PF120TP2 (2x) Walking pivot
- B PF120 (2x) Top door patch fitting
- C PF110 (2x) Bottom door patch fitting + Dorex 40 (2x)
- D PF165CM (2x) Door stop
- E 18R/Q/T (2x) Mitered Door Pulls
19R/Q (2x) Ladder Door Pulls
20R/Q (2x) Offset Door Pulls



- F PF180 (2x) Floor deadbolt
PF181 (2x) Floor deadbolt

DDSSL-1B

Basic **with door lock**, + concealed floor closer

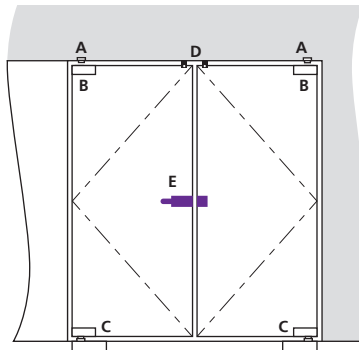

- A PF120TP1 (2x) Top pivot, fixed or PF120TP2 (2x) Walking pivot
- B PF120 (2x) Top door patch fitting
- C PF110 (2x) Bottom door patch fitting + Dorex 40 (2x)
- D PF165CM (2x) Door stop
- E* PF210 (1x) Passage Lock + PF200 (1x) Strike
PF251 (1x) Entry Lock (KIK) + PF200 (1x) Strike
PF251P (1x) Entry lock (Profile) + PF200 (1x) Strike

DDSSL-2A

Top closer **with pulls**, + overhead concealed door closer

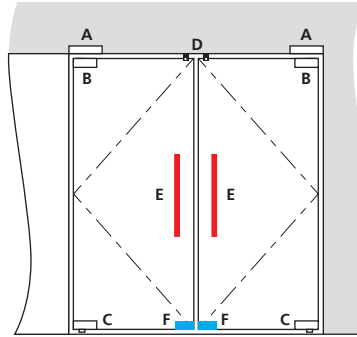

- A DOREX 30 (2x) Transom door closer
- B PF150 (2x) Top door patch fitting
- C PF110 (2x) Bottom door patch fitting + PF110BP1 Floor pivot
- D PF165CM (2x) Door stop
- E 18R/Q/T (2x) Mitered Door Pulls
19R/Q (2x) Ladder Door Pulls
20R/Q (2x) Offset Door Pulls



- F PF180 (2x) Floor deadbolt
PF181 (2x) Floor deadbolt

DDSSL-2B

Top closer **with door lock**, + overhead concealed door closer

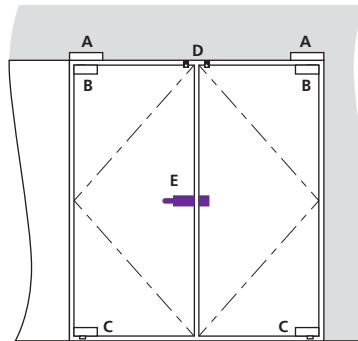

- A DOREX 30 (2x) Transom door closer
- B PF150 (2x) Top door patch fitting
- C PF110 (2x) Bottom door patch fitting
- D PF165CM (2x) Door stop
- E* PF210 (1x) Passage Lock + PF200 (1x) Strike
PF251 (1x) Entry Lock (KIK) + PF200 (1x) Strike
PF251P (1x) Entry lock (Profile) + PF200 (1x) Strike

DDSSL-3A

Hydraulic patch fitting closer **with pulls**

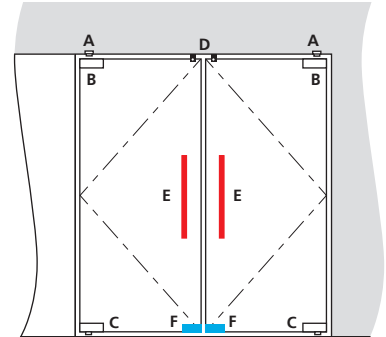

- A PF120TP1 (2x) Top pivot, fixed or PF120TP2 (2x) Walking pivot
- B PF121 (2x) Top door patch fitting
- C PF100DC / PF102DC (2x) Hydraulic patch fitting closer or PF100DCHO / PF102DCHO (2x) Hydraulic patch fitting closer, hold open
- D PF165CM (2x) Door stop
- E 18R/Q/T (2x) Mitered Door Pulls
19R/Q (2x) Ladder Door Pulls
20R/Q (2x) Offset Door Pulls



- F PF180 (2x) Floor deadbolt
PF181 (2x) Floor deadbolt

DDSSL-3B

Hydraulic patch fitting closer **with door lock**

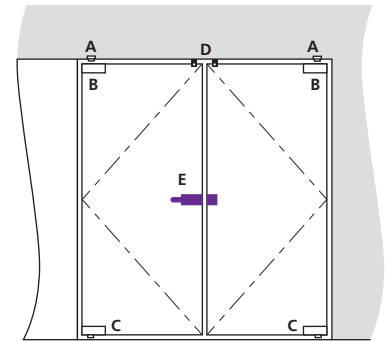

- A PF120TP1 (2x) Top pivot, fixed or PF120TP2 (2x) Walking pivot
- B PF121 (2x) Top door patch fitting
- C PF100DC / PF102DC (2x) Hydraulic patch fitting closer or PF100DCHO / PF102DCHO (2x) Hydraulic patch fitting closer, hold open
- D PF165CM (2x) Door stop
- E* PF210 (1x) Passage Lock + PF200 (1x) Strike
PF251 (1x) Entry Lock (KIK) + PF200 (1x) Strike
PF251P (1x) Entry lock (Profile) + PF200 (1x) Strike

DOUBLE DOORS + SINGLE SIDELIGHT RIGHT (DDSSR)

DDSSR-1A

Basic **with pulls**, + concealed floor closer

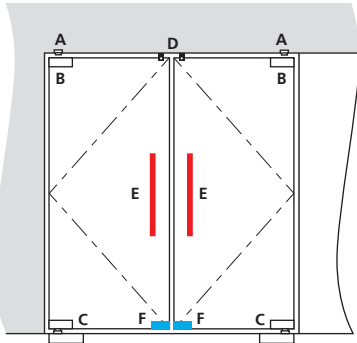

- A PF120TP1 (2x) Top pivot, fixed or PF120TP2 (2x) Walking pivot
- B PF120 (2x) Top door patch fitting
- C PF110 (2x) Bottom door patch fitting + Dorex 40 (2x)
- D PF165CM (2x) Door stop
- E 18R/Q/T (2x) Mitered Door Pulls
19R/Q (2x) Ladder Door Pulls
20R/Q (2x) Offset Door Pulls



- F PF180 (2x) Floor deadbolt
PF181 (2x) Floor deadbolt

DDSSR-1B

Basic **with door lock**, + concealed floor closer

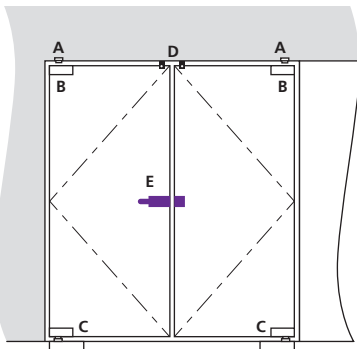

- A PF120TP1 (2x) Top pivot, fixed or PF120TP2 (2x) Walking pivot
- B PF120 (2x) Top door patch fitting
- C PF110 (2x) Bottom door patch fitting + Dorex 40 (2x)
- D PF165CM (2x) Door stop
- E* PF210 (1x) Passage Lock + PF200 (1x) Strike
PF251 (1x) Entry Lock (KIK) + PF200 (1x) Strike
PF251P (1x) Entry lock (Profile) + PF200 (1x) Strike

DDSSR-2A

Top closer **with pulls**, + overhead concealed door closer

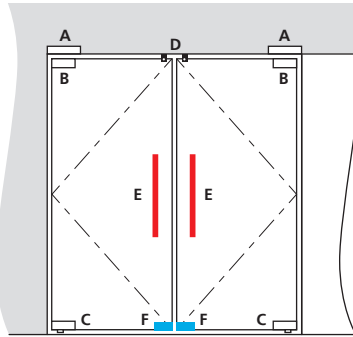

- A DOREX 30 (2x) Transom door closer
- B PF150 (2x) Top door patch fitting
- C PF110 (2x) Bottom door patch fitting + PF110BP1 Floor pivot
- D PF165CM (2x) Door stop
- E 18R/Q/T (2x) Mitered Door Pulls
19R/Q (2x) Ladder Door Pulls
20R/Q (2x) Offset Door Pulls



- F PF180 (2x) Floor deadbolt
PF181 (2x) Floor deadbolt

DDSSR-2B

Top closer **with door lock**, + overhead concealed door closer

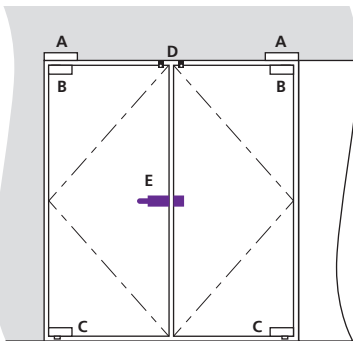

- A DOREX 30 (2x) Transom door closer
- B PF150 (2x) Top door patch fitting
- C PF110 (2x) Bottom door patch fitting + PF110BP1 Floor pivot
- D PF165CM (2x) Door stop
- E* PF210 (1x) Passage Lock + PF200 (1x) Strike
PF251 (1x) Entry Lock (KIK) + PF200 (1x) Strike
PF251P (1x) Entry lock (Profile) + PF200 (1x) Strike

DDSSR-3A

Hydraulic patch fitting closer **with pulls**

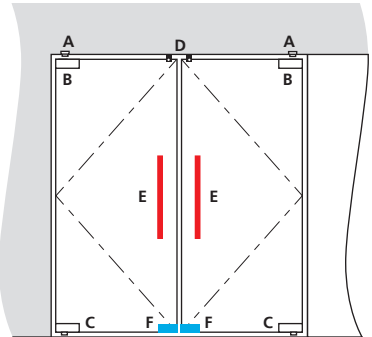

- A PF120TP1 (2x) Top pivot, fixed or PF120TP2 (2x) Walking pivot
- B PF121 (2x) Top door patch fitting
- C PF100DC / PF102DC (2x) Hydraulic patch fitting closer or PF100DCHO / PF102DCHO (2x) Hydraulic patch fitting closer, hold open
- D PF165CM (2x) Door stop
- E 18R/Q/T (2x) Mitered Door Pulls
19R/Q (2x) Ladder Door Pulls
20R/Q (2x) Offset Door Pulls



- F PF180 (2x) Floor deadbolt
PF181 (2x) Floor deadbolt

DDSSR-3B

Hydraulic patch fitting closer **with door lock**

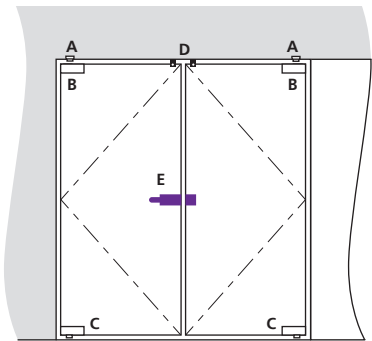

- A PF120TP1 (2x) Top pivot, fixed or PF120TP2 (2x) Walking pivot
- B PF121 (2x) Top door patch fitting
- C PF100DC / PF102DC (2x) Hydraulic patch fitting closer or PF100DCHO / PF102DCHO (2x) Hydraulic patch fitting closer, hold open
- D PF165CM (2x) Door stop
- E* PF210 (1x) Passage Lock + PF200 (1x) Strike
PF251 (1x) Entry Lock (KIK) + PF200 (1x) Strike
PF251P (1x) Entry lock (Profile) + PF200 (1x) Strike

DOUBLE DOORS + DOUBLE SIDELIGHT (DDDS)

DDDS-1A

Basic **with pulls**, + concealed floor closer

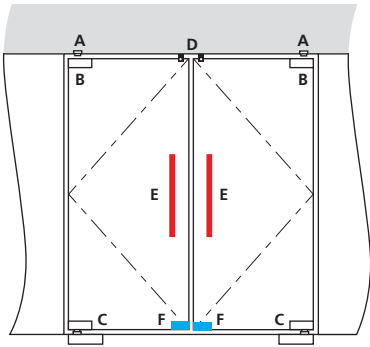

- A PF120TP1 (2x) Top pivot, fixed or PF120TP2 (2x) Walking pivot
- B PF120 (2x) Top door patch fitting
- C PF110 (2x) Bottom door patch fitting + Dorex 40 (2x)
- D PF165CM (2x) Door stop
- E 18R/Q/T (2x) Mitered Door Pulls
19R/Q (2x) Ladder Door Pulls
20R/Q (2x) Offset Door Pulls



- F PF180 (2x) Floor deadbolt
PF181 (2x) Floor deadbolt

DDDS-1B

Basic **with door lock**, + concealed floor closer

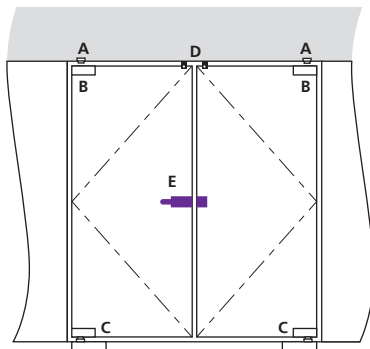

- A PF120TP1 (2x) Top pivot, fixed or PF120TP2 (2x) Walking pivot
- B PF120 (2x) Top door patch fitting
- C PF110 (2x) Bottom door patch fitting + Dorex 40 (2x)
- D PF165CM (2x) Door stop
- E* PF210 (1x) Passage Lock + PF200 (1x) Strike
PF251 (1x) Entry Lock (KIK) + PF200 (1x) Strike
PF251P (1x) Entry lock (Profile) + PF200 (1x) Strike

DDDS-2A

Top closer **with pulls**, + overhead concealed door closer

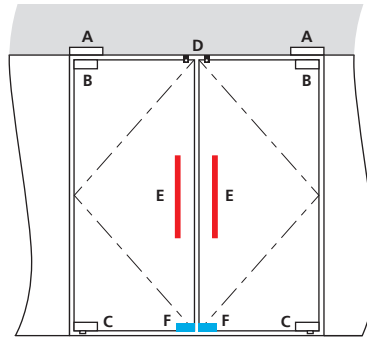

- A DOREX 30 (2x) Transom door closer
- B PF150 (2x) Top door patch fitting
- C PF110 (2x) Bottom door patch fitting + PF110BP1 Floor pivot
- D PF165CM (2x) Door stop
- E 18R/Q/T (2x) Mitered Door Pulls
19R/Q (2x) Ladder Door Pulls
20R/Q (2x) Offset Door Pulls



- F PF180 (2x) Floor deadbolt
PF181 (2x) Floor deadbolt

DDDS-2B

Top closer **with door lock**, + overhead concealed door closer

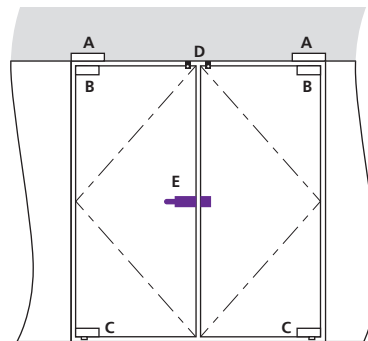

- A DOREX 30 (2x) Transom door closer
- B PF150 (2x) Top door patch fitting
- C PF110 (2x) Bottom door patch fitting + PF110BP1 Floor pivot
- D PF165CM (2x) Door stop
- E* PF210 (1x) Passage Lock + PF200 (1x) Strike
PF251 (1x) Entry Lock (KIK) + PF200 (1x) Strike
PF251P (1x) Entry lock (Profile) + PF200 (1x) Strike

DDDS-3A

Hydraulic patch fitting closer **with pulls**

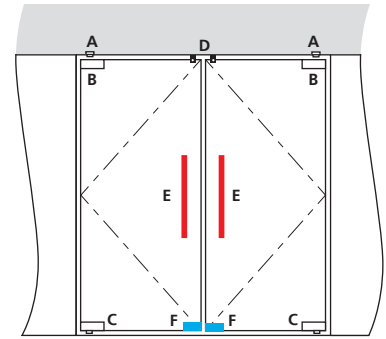

- A PF120TP1 (2x) Top pivot, fixed or PF120TP2 (2x) Walking pivot
- B PF121 (2x) Top door patch fitting
- C PF100DC / PF102DC (2x) Hydraulic patch fitting closer or PF100DCHO / PF102DCHO (2x) Hydraulic patch fitting closer, hold open
- D PF165CM (2x) Door stop
- E 18R/Q/T (2x) Mitered Door Pulls
19R/Q (2x) Ladder Door Pulls
20R/Q (2x) Offset Door Pulls



- F PF180 (2x) Floor deadbolt
PF181 (2x) Floor deadbolt

DDDS-3B

Hydraulic patch fitting closer **with door lock**

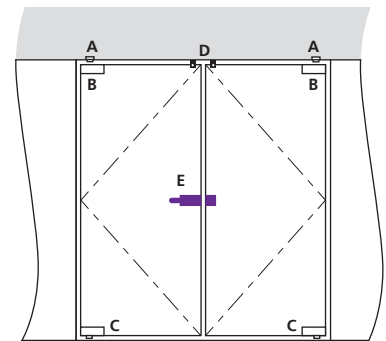

- A PF120TP1 (2x) Top pivot, fixed or PF120TP2 (2x) Walking pivot
- B PF121 (2x) Top door patch fitting
- C PF100DC / PF102DC (2x) Hydraulic patch fitting closer or PF100DCHO / PF102DCHO (2x) Hydraulic patch fitting closer, hold open
- D PF165CM (2x) Door stop
- E* PF210 (1x) Passage Lock + PF200 (1x) Strike
PF251 (1x) Entry Lock (KIK) + PF200 (1x) Strike
PF251P (1x) Entry lock (Profile) + PF200 (1x) Strike

DOUBLE DOORS WITH TRANSOM + SINGLE SIDELIGHT RIGHT (DDTSSR)

DDTSSR-1A

Basic **with pulls**, + concealed floor closer

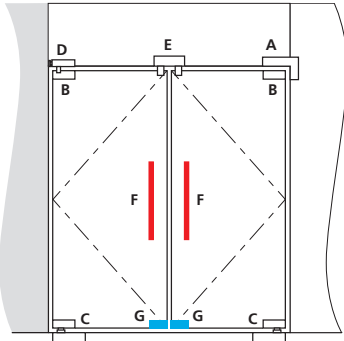

- A **PF140** (1x) Transom corner patch
- B **PF120** (2x) Top door patch fitting
- C **PF110** (2x) Bottom door patch fitting + **Dorex 40** (2x)
- D **PF130** (1x) Transom patch fitting with pivot
- E **PF165** (1x) Transom connector with door stop
- F **18R/Q/T** (2x) Mitered Door Pulls
19R/Q (2x) Ladder Door Pulls
20R/Q (2x) Offset Door Pulls



- G **PF180** (2x) Floor deadbolt
PF181 (2x) Floor deadbolt

DDTSSR-1B

Basic **with door lock**, + concealed floor closer

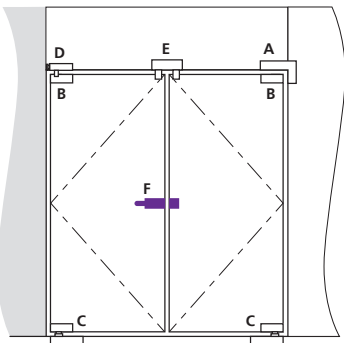

- A **PF140** (1x) Transom corner patch fitting
- B **PF120** (2x) Top door patch fitting
- C **PF110** (2x) Bottom door patch fitting + **Dorex 40** (2x)
- D **PF130** (1x) Transom patch fitting with pivot
- E **PF165** (1x) Transom connector with door stop
- F* **PF210** (1x) Passage Lock + **PF200** Strike
PF251 (1x) Entry Lock (KIK) + **PF200** Strike
PF251P (1x) Entry lock (Profile) + **PF200** Strike

DDTSSR-3A

Hydraulic patch fitting closer **with pulls**

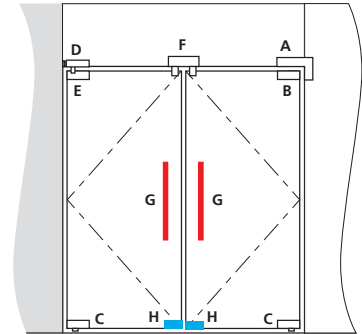

- A **PF140** (1x) Transom corner patch fitting
- B **PF120** (1x) Top door patch fitting
- C **PF100DC / PF102DC** (2x) Hydraulic patch fitting closer or **PF100DCHO / PF102DCHO** (2x) Hydraulic patch fitting closer, hold open
- D **PF131** (1x) Transom patch fitting with pivot
- E **PF121** (1x) Top door patch fitting
- F **PF165** (1x) Transom connector with door stop
- G **18R/Q/T** (2x) Mitered Door Pulls
19R/Q (2x) Ladder Door Pulls
20R/Q (2x) Offset Door Pulls



- H **PF180** (2x) Floor deadbolt
PF181 (2x) Floor deadbolt

DDTSSR-3B

Hydraulic patch fitting closer **with door lock**

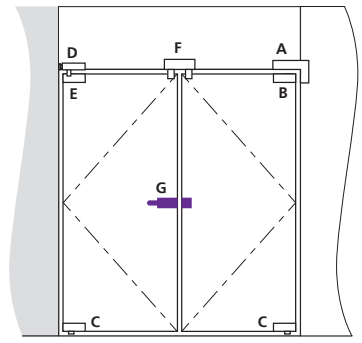

- A **PF140** (1x) Transom corner patch fitting
- B **PF120** (1x) Top door patch fitting
- C **PF100DC / PF102DC** (2x) Hydraulic patch fitting closer or **PF100DCHO / PF102DCHO** (2x) Hydraulic patch fitting closer, hold open
- D **PF131** (1x) Transom patch fitting with pivot
- E **PF121** (1x) Top door patch fitting
- F **PF165** (1x) Transom connector with door stop
- G* **PF210** (1x) Passage Lock + **PF200** Strike
PF251 (1x) Entry Lock (KIK) + **PF200** Strike
PF251P (1x) Entry lock (Profile) + **PF200** Strike

DOUBLE DOORS WITH TRANSOM + SINGLE SIDELIGHT LEFT (DDTSSL)

DDTSSL-1A

Basic **with pulls**, + concealed floor closer

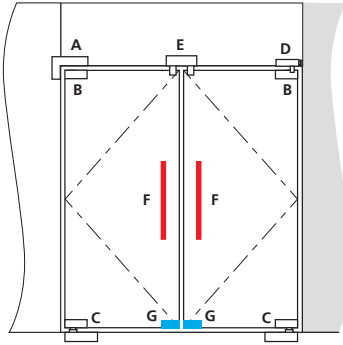

- A **PF140** (1x) Transom corner patch fitting
- B **PF120** (2x) Top door patch fitting
- C **PF110** (2x) Bottom door patch fitting + **Dorex 40** (2x)
- D **PF130** (1x) Transom patch fitting with pivot
- E **PF165** (1x) Transom connector with door stop
- F **18R/Q/T** (2x) Mitered Door Pulls
19R/Q (2x) Ladder Door Pulls
20R/Q (2x) Offset Door Pulls



- G **PF180** (2x) Floor deadbolt
PF181 (2x) Floor deadbolt

DDTSSL-3A

Hydraulic patch fitting closer **with pulls**

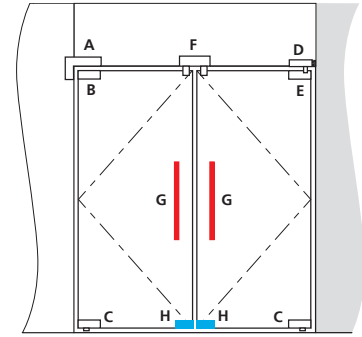

- A **PF140** (1x) Transom corner patch fitting
- B **PF120** (1x) Top door patch fitting
- C **PF100DC / PF102DC** (2x) Hydraulic patch fitting closer or **PF100DCHO / PF102DCHO** (2x) Hydraulic patch fitting closer, hold open
- D **PF131** (1x) Transom patch fitting with pivot
- E **PF121** (1x) Top door patch fitting
- F **PF165** (1x) Transom connector with door stop
- G **18R/Q/T** (2x) Mitered Door Pulls
19R/Q (2x) Ladder Door Pulls
20R/Q (2x) Offset Door Pulls



- H **PF180** (2x) Floor deadbolt
PF181 (2x) Floor deadbolt

DDTSSL-1B

Basic **with door lock**, + concealed floor closer

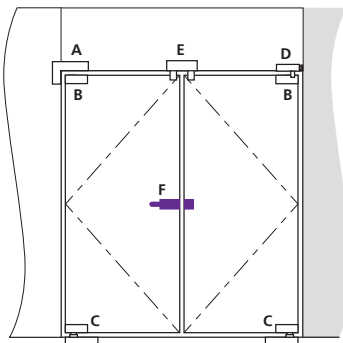

- A **PF140** (1x) Transom corner patch fitting
- B **PF120** (2x) Top door patch fitting
- C **PF110** (2x) Bottom door patch fitting + **Dorex 40** (2x)
- D **PF130** (1x) Transom patch fitting with pivot
- E **PF165** (1x) Transom connector with door stop
- F* **PF210** (1x) Passage Lock + **PF200** Strike
PF251 (1x) Entry Lock (KIK) + **PF200** Strike
PF251P (1x) Entry lock (Profile) + **PF200** Strike

DDTSSL-3B

Hydraulic patch fitting closer **with door lock**

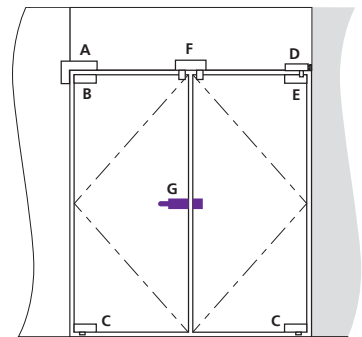

- A **PF140** (1x) Transom corner patch fitting
- B **PF120** (2x) Top door patch fitting
- C **PF100DC / PF102DC** (2x) Hydraulic patch fitting closer or **PF100DCHO / PF102DCHO** (2x) Hydraulic patch fitting closer, hold open
- D **PF131** (1x) Transom patch fitting with pivot
- E **PF121** (1x) Top door patch fitting
- F **PF165** (1x) Transom connector with door stop
- G* **PF210** (1x) Passage Lock + **PF200** Strike
PF251 (1x) Entry Lock (KIK) + **PF200** Strike
PF251P (1x) Entry lock (Profile) + **PF200** Strike

DOUBLE DOORS WITH TRANSOM + DOUBLE SIDELIGHT (DDTDS)

DDTDS-1A

Basic **with pulls**, + concealed floor closer

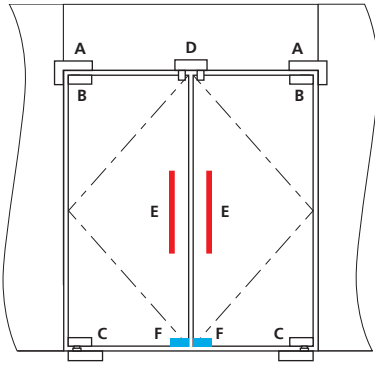

- A **PF140** (2x) Transom corner patch fitting
- B **PF120** (2x) Top door patch fitting
- C **PF110** (2x) Bottom door patch fitting + **Dorex 40** (2x)
- D **PF165** (1x) Transom connector with door stop
- E **18R/Q/T** (2x) Mitered Door Pulls
19R/Q (2x) Ladder Door Pulls
20R/Q (2x) Offset Door Pulls



- F **PF180** (2x) Floor deadbolt
PF181 (2x) Floor deadbolt

DDTDS-1B

Basic **with door lock**, + concealed floor closer

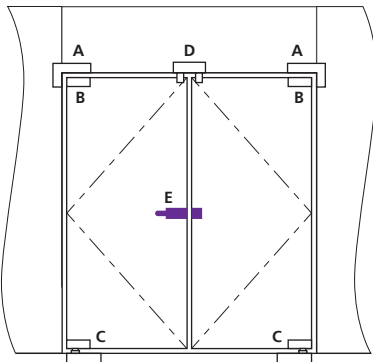

- A **PF140** (2x) Transom corner patch fitting
- B **PF120** (2x) Top door patch fitting
- C **PF110** (2x) Bottom door patch fitting + **Dorex 40** (2x)
- D **PF165** (1x) Transom connector with door stop
- E* **PF210** (1x) Passage Lock + **PF200** Strike
PF251 (1x) Entry Lock (KIK) + **PF200** Strike
PF251P (1x) Entry lock (Profile) + **PF200** Strike

DDTDS-3A

Hydraulic patch fitting closer **with pulls**

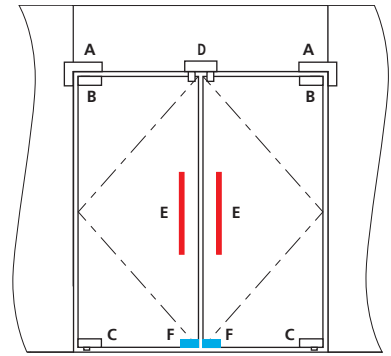

- A **PF140** (2x) Transom corner patch fitting
- B **PF120** (2x) Top door patch fitting
- C **PF100DC / PF102DC** (2x) Hydraulic patch fitting closer or **PF100DCHO / PF102DCHO** (2x) Hydraulic patch fitting closer, hold open
- D **PF165** (1x) Transom connector with door stop
- E **18R/Q/T** (2x) Mitered Door Pulls
19R/Q (2x) Ladder Door Pulls
20R/Q (2x) Offset Door Pulls



- F **PF180** (2x) Floor deadbolt
PF181 (2x) Floor deadbolt

DDTDS-3B

Hydraulic patch fitting closer **with door lock**

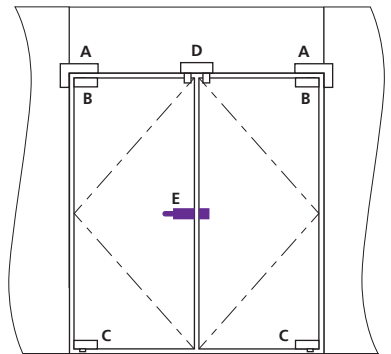

- A **PF140** (2x) Transom corner patch fitting
- B **PF120** (2x) Top door patch fitting
- C **PF100DC / PF102DC** (2x) Hydraulic patch fitting closer or **PF100DCHO / PF102DCHO** (2x) Hydraulic patch fitting closer, hold open
- D **PF165** (1x) Transom connector with door stop
- E* **PF210** (1x) Passage Lock + **PF200** Strike
PF251 (1x) Entry Lock (KIK) + **PF200** Strike
PF251P (1x) Entry lock (Profile) + **PF200** Strike

GLASS DOOR LOCKS

AVAILABLE LEVER STYLES



PFL001-32D
Straight lever style (sold in pairs)



PFL018-32D
Curved lever style (sold in pairs)

*Other levers styles are available by special order.
Special orders may require additional lead times and/or
minimum order quantities.
Please verify availability with your local sales representative.*

