



TABLE OF CONTENTS GENERAL HARDWARE

Finish Guide.....	ii
Abbreviation Guide.....	iii

PULL HANDLES & PLATES

Door Pulls	06.010
Aluminum Door Pulls	06.023
Flush Pulls	06.025
Edge Pulls	06.030
Pulls, Multi-purpose	06.040
Door Pulls & Plates	06.050
Push & Kick Plates.....	06.060
Kick, Push & Back Plates.....	06.061

DOOR STOPS & HOLDERS

Floor Stops.....	06.110
Wall Stops	06.120
Roller Bumpers.....	06.125
Hinge Pin Stops.....	06.130
Door Stops with Holder.....	06.140
Door Holders	06.150
Check Chains.....	06.160

DOOR ACCESSORIES

Mail Slots.....	06.200
Signage	06.220
Weather Stripping and Gasketing	06.250

BOLTS & HASPS

Flush Bolts	06.300
Surface Bolts.....	06.320
Tower & Barrel Bolts	06.330
Padbolts & Gate Latches	06.340
Safety Hasps	06.350

TRIMMER HARDWARE

Closet Hardware	06.510
Wardrobe Hooks.....	06.520
Handrail Brackets.....	06.530
Door Catches & Latches	06.540

LAVATORY HARDWARE

Lavatory Partition	06.600
Bath Hardware.....	06.610

CABINET HARDWARE

Magnetic Catches	06.700
Ball & Roller Catches	06.710
Reinforcement Hardware	06.740

SLIDING HARDWARE





























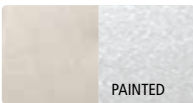

Sliding Door Hardware	06.810
By-Pass Door Hardware.....	06.820
Bi-Fold Door Hardware	06.830
Sliding Tracks.....	06.840
Accessories	06.850

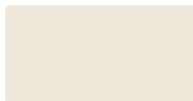
WINDOW HARDWARE

Window Catches & Latches.....	06.900
Window Hardware, Cremona	06.910



GENERAL HARDWARE FINISH GUIDE

				
PRIME COATED	BLACK JAPANED / LACQ.	MATTE BLACK LACQUER	ZINC PLATED	YELLOW ZINC PLATED
CODE CP	C1B, KJ	C1D	C2G, ZP	C2GY, YZ
BHMA* 600	601	693	603	
				
POLISHED BRASS	MIRROR POLISHED BRASS	SATIN BRASS	ANTIQUE BRASS	SATIN BRONZE
CODE BP, BP032, C3, 3	C3M, 3M	C4, 4, SDB	AB, C5, 5	C10, 10
BHMA* 605, 632		606, 633	609, 638	612, 639
				
OIL RUBBED BRONZE	POLISHED NICKEL	SATIN NICKEL	ANTIQUE NICKEL	MATTE BLACK
CODE C10B, 10B	NP, C14, 14	SDN, SN, C15, 15	AN, C15A, 15A	C19, 19
BHMA* 613, 640	645	619, 646	620, 647	622, 631
				
DARK BRONZE	POLISHED CHROME	SATIN CHROME	POLISHED STAINLESS STEEL	SATIN STAINLESS STEEL
CODE BLR, DU, C20D, 20D	CHR, C26, 26	SC, C26D, 26D	C32, 32	SS, ST, C32D, 32D
BHMA* 650, 690, 695	625, 651	626, 652	629	630
				
ALUMINUM	PLAIN STEEL, NO FINISH			
CODE AL, C28, 28	PS			
BHMA* 628, 689				
				
ALMOND WHITE	LIGHT BRONZE	EPOXY BLACK	EPOXY WHITE	SATIN WHITE
CODE ALMOND, AW	BZ	EXB	EXW	WSILK
BHMA*				
				
WHITE	BROWN	SILVER PAINT	GOLD PAINT	
CODE WH, WHITE	B	SL	GD	
BHMA*				

ALL FINISHES IMAGES ABOVE ARE PHOTOGRAPHIC OR COLOUR APPROXIMATIONS, DELIVERED PRODUCT MAY VARY IN COMPARISON OR BETWEEN ORDERS/BATCHES. OTHER FINISHES AVAILABLE—PLEASE CONTACT.
 (*) EQUIVALENT; CODES DIFFER DEPENDING ON BASE MATERIAL AND/OR FINISH PROCESS.

GENERAL HARDWARE ABBREVIATION GUIDE

GENERAL

BS	Backset
DIA, \varnothing	Diameter
KG	Kilograms
LBS	Pounds
LH	Left hand
LHR	Left hand reversed
MAX	Maximum
MIN	Minimum
N/A, —	Not applicable / Not available
QTY	Quantity (usually followed by notes)
RH	Right hand
RHR	Right hand reversed
SQ, \square	Square
WT	Weight
/UNIT	Number of items per basic unit of sale (bagged or boxed)
/BOX, /BAG	Number of UNITS found in an inner carton or bag
/CASE	Number of BOXES or UNITS found in an outer (shipping) carton

LEGEND



Tested to Canadian and/or American safety and performance standards by Underwriters Laboratories® (UL).



DOOR PULLS

GENERAL HARDWARE

DOREX 19R-E SERIES

LADDER PULLS, ROUND, 1 1/4" DIAMETER



1 1/4"
32 mm
Diameter (E)



Single pulls are thru-bolt mounted with round end-caps

APPLICATIONS

- For wood or metal doors 1 3/8–2 1/4" (35–57 mm) thick
- For glass doors 5/16–1/2" (8–13 mm) thick

FEATURES

- 304 Stainless steel
- Available in paired or single pulls
- Single pulls are thru-bolt mounted with round end-caps
- All necessary mounting hardware included
- Matching washers for different finishes included
- Packaged in an eco-friendly, fully recyclable, box



630
SATIN STAINLESS
STEEL



19
MATTE BLACK

SELECTION GUIDE

SERIES	LENGTH [†]	DIAMETER	TYPE	FINISH	DESCRIPTION
19R	24	E	B	630	Ladder Pull, 1 1/4" (32 mm) Round, 24" Center-to-Center, Back-to-Back, Satin Stainless Steel
	12, 24, 36 48, 60, 72	E 1-1/4 (32)	B Back-to-Back S Single	630 Satin Stainless Steel 19 Matte black	

IN (MM), (†) CENTER-TO-CENTER.

NOT ALL COMBINATIONS OF STANDARD LENGTHS, TYPES & FINISHES ARE STOCKED. PLEASE REFER TO PRICE LIST OR CONTACT CANAROPA SALES AND SERVICE FOR DETAILS.

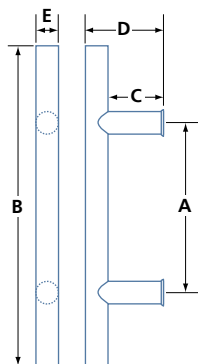

DIMENSIONS

MODEL	A CENTER-TO-CENTER	B TOTAL LENGTH	C POSTS	D PROJECTION	E DIAMETER
19R12	12 (305)	24 (610)	2 7/16 (62)	3 11/16 (94)	1 1/4 (32)
19R24	24 (610)	36 (915)	2 7/16 (62)	3 11/16 (94)	1 1/4 (32)
19R36	36 (915)	48 (1220)	2 7/16 (62)	3 11/16 (94)	1 1/4 (32)
19R48	48 (1220)	60 (1524)	2 7/16 (62)	3 11/16 (94)	1 1/4 (32)
19R60	60 (1524)	72 (1829)	2 7/16 (62)	3 11/16 (94)	1 1/4 (32)
19R72	72 (1829)	84 (2134)	2 7/16 (62)	3 11/16 (94)	1 1/4 (32)

IN (MM)

DOOR PULLS

GENERAL HARDWARE

DOREX 19R-E45 SERIES

LADDER PULLS, ROUND, 1 1/4" DIAMETER, OFFSET POSTS



APPLICATIONS

- For wood or metal doors 1 3/8–2 1/4" (35–57 mm) thick
- For glass doors 5/16–1/2" (8–13 mm) thick

FEATURES

- 304 Stainless steel
- Available in paired or single pulls
- Pull is offset for better functionality and aesthetics
- Simplified Stock Management: Convert back-to-back pairs to singles, and vice-versa (kit sold separately)
- Single pulls are thru-bolt mounted with round end-caps
- All necessary mounting hardware included
- Matching washers for different finishes included
- Offset clearance 2 25/32" (70.6 mm)

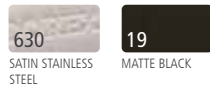

SELECTION GUIDE

SERIES	LENGTH†	DIAMETER	TYPE	OPTION	FINISH	DESCRIPTION
19R	24	E	B	45	630	Ladder Pull, 1 1/4" (32 mm) Round, 24" Center-to-Center, Back-to-Back, 45°, Satin Stainless Steel
	12, 24, 36 48, 60, 72	E 1-1/4 (32)	B Back-to-Back S Single	45 45 Degree	630 Satin Stainless Steel 19 Matte black	

IN (MM), †) CENTER-TO-CENTER.

NOT ALL COMBINATIONS OF STANDARD LENGTHS, TYPES & FINISHES ARE STOCKED. PLEASE REFER TO PRICE LIST OR CONTACT CANAROPA SALES AND SERVICE FOR DETAILS.



Single pulls are thru-bolt mounted with round end-caps

ACCESSORIES

19R45-B2B2SING-KIT-630	Kit to Reconfigure 1x 19R45-B2B PAIR to 2x 19R45-SINGLE-630
19R45-B2B2SING-KIT-19	Kit to Reconfigure 1x 19R45-B2B PAIR to 2x 19R45-SINGLE-19
19R45-2SING2B2B-KIT-630	Kit to Reconfigure 2x 19R45-SINGLE to 1x 19R45-B2B PAIR-630
19R45-2SING2B2B-KIT-19	Kit to Reconfigure 2x 19R45-SINGLE to 1x 19R45-B2B PAIR-19

DIMENSIONS

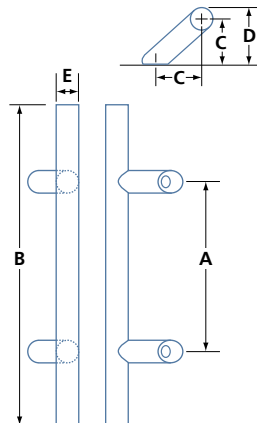

MODEL	A CENTER-TO-CENTER	B TOTAL LENGTH	C POSTS	D PROJECTION	E DIAMETER
19R12	12 (305)	24 (610)	2 25/32 (70.6)	3 13/32 (86.6)	1 1/4 (32)
19R24	24 (610)	36 (915)	2 25/32 (70.6)	3 13/32 (86.6)	1 1/4 (32)
19R36	36 (915)	48 (1220)	2 25/32 (70.6)	3 13/32 (86.6)	1 1/4 (32)
19R48	48 (1220)	60 (1524)	2 25/32 (70.6)	3 13/32 (86.6)	1 1/4 (32)
19R60	60 (1524)	72 (1829)	2 25/32 (70.6)	3 13/32 (86.6)	1 1/4 (32)
19R72	72 (1829)	84 (2134)	2 25/32 (70.6)	3 13/32 (86.6)	1 1/4 (32)

IN (MM)



DOOR PULLS

GENERAL HARDWARE

DOREX 19R-E 316 SERIES

LADDER PULLS, ROUND, 1¼" DIAMETER, 316 MARINE GRADE



APPLICATIONS

- For wood or metal doors 1⅜–2¼" (35–57 mm) thick
- For glass doors ⅝–½" (8–13 mm) thick
- Ideal for outdoor use

FEATURES

- Marine grade, 316 stainless steel
- Available in paired or single pulls
- Single pulls are thru-bolt mounted with round end-caps
- All necessary mounting hardware included
- Washers included
- Packaged in an eco-friendly, fully recyclable, box



SELECTION GUIDE

SERIES	LENGTH†	DIAMETER	TYPE	FINISH	DESCRIPTION
19R	24, 36, 48, 60	E 1-1/4 (32)	B Back-to-Back S Single	316 Satin Stainless Steel	Ladder Pull, 1¼" (32 mm) Round, 24" Center-to-Center, Back-to-Back, 316 Satin Stainless Steel

IN (MM), †) CENTER-TO-CENTER.

NOT ALL COMBINATIONS OF STANDARD LENGTHS, TYPES & FINISHES ARE STOCKED. PLEASE REFER TO PRICE LIST OR CONTACT CANAROPA SALES AND SERVICE FOR DETAILS.



Single pulls are thru-bolt mounted with round end-caps

DIMENSIONS

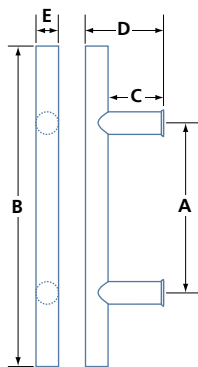

MODEL	A CENTER-TO-CENTER	B TOTAL LENGTH	C POSTS	D PROJECTION	E DIAMETER
19R12	12 (305)	24 (610)	2⅞ (62)	3⅞ (94)	1¼ (32)
19R24	24 (610)	36 (915)	2⅞ (62)	3⅞ (94)	1¼ (32)
19R36	36 (915)	48 (1220)	2⅞ (62)	3⅞ (94)	1¼ (32)
19R48	48 (1220)	60 (1524)	2⅞ (62)	3⅞ (94)	1¼ (32)
19R60	60 (1524)	72 (1829)	2⅞ (62)	3⅞ (94)	1¼ (32)

IN (MM)

DOOR PULLS

GENERAL HARDWARE

DOREX 19Q-E SERIES

LADDER PULLS, SQUARE, 1 1/4"

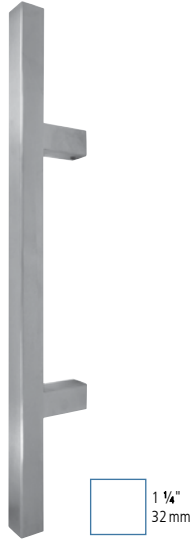

Single pulls are thru-bolt mounted with round end-caps

APPLICATIONS

- For wood or metal doors 1 3/8–2 1/4" (35–57 mm) thick
- For glass doors 5/16– 1/2" (8–13 mm) thick

FEATURES

- 304 Stainless steel
- Available in paired or single pulls
- Single pulls are thru-bolt mounted with round end-caps
- All necessary mounting hardware included
- Matching washers for different finishes included
- Packaged in an eco-friendly, fully recyclable, box



SELECTION GUIDE

SERIES	LENGTH†	DIAMETER	TYPE	FINISH	DESCRIPTION
19Q	24	E	B	630	Ladder Pull, 1 1/4" (32 mm) Square, 24" Center-to-Center, Back-to-Back, Satin Stainless Steel
	12, 24, 36 48, 60, 72	E 1-1/4 (32)	B Back-to-Back S Single	630 Satin Stainless Steel 19 Matte black	

IN (MM), †) CENTER-TO-CENTER.

NOT ALL COMBINATIONS OF STANDARD LENGTHS, TYPES & FINISHES ARE STOCKED. PLEASE REFER TO PRICE LIST OR CONTACT CANAROPA SALES AND SERVICE FOR DETAILS.

DIMENSIONS

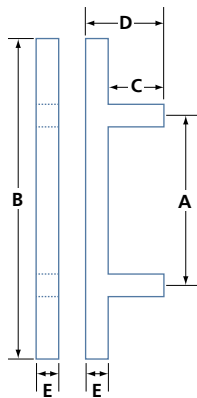

MODEL	A CENTER-TO-CENTER	B TOTAL LENGTH	C POSTS	D PROJECTION	E GRIP
19Q12	12 (305)	24 (610)	2 7/16 (62)	3 1/16 (94)	1 1/4 (32)
19Q24	24 (610)	36 (915)	2 7/16 (62)	3 1/16 (94)	1 1/4 (32)
19Q36	36 (915)	48 (1220)	2 7/16 (62)	3 1/16 (94)	1 1/4 (32)
19Q48	48 (1220)	60 (1524)	2 7/16 (62)	3 1/16 (94)	1 1/4 (32)
19Q60	60 (1524)	72 (1829)	2 7/16 (62)	3 1/16 (94)	1 1/4 (32)
19Q72	72 (1829)	84 (2134)	2 7/16 (62)	3 1/16 (94)	1 1/4 (32)

IN (MM)



DOOR PULLS

GENERAL HARDWARE

DOREX 18R-E SERIES

STRAIGHT ROUND PULLS, MITERED, 1 1/4" DIAMETER

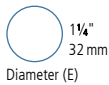

APPLICATIONS

- For wood or metal doors 1 3/8 – 2 1/4" (35–57 mm) thick
- For glass doors 5/16 – 1/2" (8–13 mm) thick

FEATURES

- 304 Stainless steel
- Available in paired or single pulls
- Single pulls are thru-bolt mounted with round end-caps
- All necessary mounting hardware included
- Matching washers for different finishes included
- Packaged in an eco-friendly, fully recyclable, box



SELECTION GUIDE

SERIES	LENGTH†	DIAMETER	TYPE	FINISH	DESCRIPTION
18R	24	E	B	630	Straight Round Pull, 1 1/4" (32 mm) Mitered, 24" Center-to-Center, Back-to-Back, Satin Stainless Steel
	36		S	19	
	48, 60, 72	E 1-1/4 (32)	B Back-to-Back S Single	630 Satin Stainless Steel 19 Matte black	

IN (MM), † CENTER-TO-CENTER.

NOT ALL COMBINATIONS OF STANDARD LENGTHS, TYPES & FINISHES ARE STOCKED. PLEASE REFER TO PRICE LIST OR CONTACT CANAROPA SALES AND SERVICE FOR DETAILS.



Single pulls are thru-bolt mounted with round end-caps

DIMENSIONS

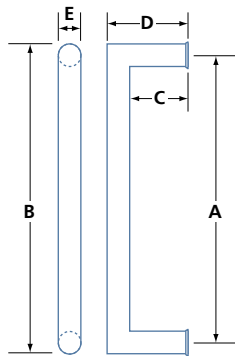

MODEL	A CENTER-TO-CENTER	B TOTAL LENGTH	C POSTS	D PROJECTION	E DIAMETER
18R24	24 (610)	25 1/4 (641)	27/16 (62)	3 1/16 (94)	1 1/4 (32)
18R36	36 (915)	37 1/4 (946)	27/16 (62)	3 1/16 (94)	1 1/4 (32)
18R48	48 (1220)	49 1/4 (1251)	27/16 (62)	3 1/16 (94)	1 1/4 (32)
18R60	60 (1524)	61 1/4 (1556)	27/16 (62)	3 1/16 (94)	1 1/4 (32)
18R72	72 (1829)	73 1/4 (1861)	27/16 (62)	3 1/16 (94)	1 1/4 (32)

IN (MM)

DOOR PULLS

GENERAL HARDWARE

DOREX 18Q-E SERIES

STRAIGHT SQUARE PULLS, MITERED, 1 1/4"



APPLICATIONS

- For wood or metal doors 1 3/8–2 1/4" (35–57 mm) thick
- For glass doors 5/16–1/2" (8–13 mm) thick

FEATURES

- 304 Stainless steel
- Available in paired or single pulls
- Single pulls are thru-bolt mounted with round end-caps
- All necessary mounting hardware included
- Matching washers for different finishes included
- Packaged in an eco-friendly, fully recyclable, box



SELECTION GUIDE

SERIES	LENGTH†	DIAMETER	TYPE	FINISH	DESCRIPTION
18Q	24	E	B	630	Straight Square Pull, 1 1/4" (32 mm) Mitered, 24" Center-to-Center, Back-to-Back, Satin Stainless Steel
	24, 36	E 1-1/4 (32)	B Back-to-Back	630 Satin Stainless Steel	
	48, 60, 72		S Single	19 Matte black	

IN (MM), (†) CENTER-TO-CENTER.

NOT ALL COMBINATIONS OF STANDARD LENGTHS, TYPES & FINISHES ARE STOCKED. PLEASE REFER TO PRICE LIST OR CONTACT CANAROPA SALES AND SERVICE FOR DETAILS.



Single pulls are thru-bolt mounted with round end-caps

DIMENSIONS

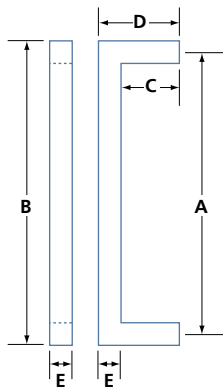

MODEL	A CENTER-TO-CENTER	B TOTAL LENGTH	C POSTS	D PROJECTION	E GRIP
18Q24	24 (610)	25 1/4 (641)	27/16 (62)	3 11/16 (94)	1 1/4 (32)
18Q36	36 (915)	37 1/4 (946)	27/16 (62)	3 11/16 (94)	1 1/4 (32)
18Q48	48 (1220)	49 1/4 (1251)	27/16 (62)	3 11/16 (94)	1 1/4 (32)
18Q60	60 (1524)	61 1/4 (1556)	27/16 (62)	3 11/16 (94)	1 1/4 (32)
18Q72	72 (1829)	73 1/4 (1861)	27/16 (62)	3 11/16 (94)	1 1/4 (32)

IN (MM)



DOOR PULLS

GENERAL HARDWARE

DOREX 18T-F SERIES

STRAIGHT RECTANGULAR PULLS, MITERED, 1½" x 1"

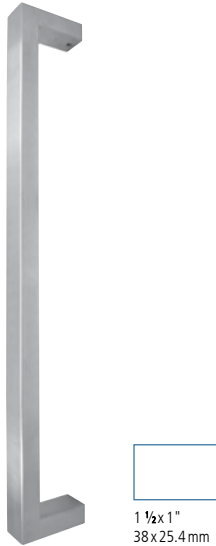

APPLICATIONS

- For wood or metal doors 1¾"– 2¼" (35–57mm) thick
- For glass doors ⅝"– ½" (8–13 mm) thick

FEATURES

- 304 Stainless steel
- Available in paired or single pulls
- Single pulls are thru-bolt mounted with round end-caps
- All necessary mounting hardware included
- Matching washers for different finishes included
- Packaged in an eco-friendly, fully recyclable, box

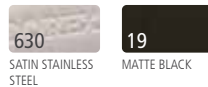

SELECTION GUIDE

SERIES	LENGTH†	DIMENSION	TYPE	FINISH	DESCRIPTION
18T	24	F	B	630	Straight Rectangular Pull, 1½x1" (38x25.4mm) Mitered, 24" Center-to-Center, Back-to-Back, Satin Stainless Steel
	24, 36 48, 60, 72	F 1-1/2x1 (38x25.4)	B Back-to-Back S Single	630 Satin Stainless Steel 19 Matte black	

IN (MM), †) CENTER-TO-CENTER.

NOT ALL COMBINATIONS OF STANDARD LENGTHS, TYPES & FINISHES ARE STOCKED. PLEASE REFER TO PRICE LIST OR CONTACT CANAROPA SALES AND SERVICE FOR DETAILS.



Single pulls are thru-bolt mounted with round end-caps

DIMENSIONS

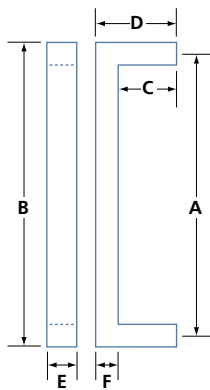

MODEL	A CENTER-TO-CENTER	B TOTAL LENGTH	C POSTS	D PROJECTION	E GRIP WIDTH	F GRIP HEIGHT
18T24	24 (610)	25 (635)	2⅝" (67)	3⅝" (92.4)	1½" (38)	1 (25.4)
18T36	36 (915)	37 (940)	2⅝" (67)	3⅝" (92.4)	1½" (38)	1 (25.4)
18T48	48 (1220)	49 (1245)	2⅝" (67)	3⅝" (92.4)	1½" (38)	1 (25.4)
18T60	60 (1524)	61 (1549)	2⅝" (67)	3⅝" (92.4)	1½" (38)	1 (25.4)
18T72	72 (1829)	73 (1854)	2⅝" (67)	3⅝" (92.4)	1½" (38)	1 (25.4)

IN (MM)

DOOR PULLS

GENERAL HARDWARE

DOREX 20R-E SERIES

OFFSET ROUND D-PULLS, MITERED, 1 1/4" DIAMETER



APPLICATIONS

- For wood or metal doors 1 3/8–2 1/4" (35–57 mm) thick
- For glass doors 5/16–1/2" (8–13 mm) thick

FEATURES

- 304 Stainless steel
- Available in paired or single pulls
- Single pulls are thru-bolt mounted with round end-caps
- All necessary mounting hardware included
- Matching washers for different finishes included
- Packaged in an eco-friendly, fully recyclable, box

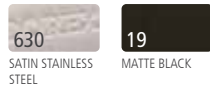

SELECTION GUIDE

SERIES	LENGTH†	DIAMETER	TYPE	FINISH	DESCRIPTION
20R	24	E	B	630	Offset Round D-Pull, 1 1/4 (32 mm) Mitered, 24" Center-to-Center, Back-to-Back, Satin Stainless Steel Finish
	10, 24, 36 48, 60	E 1-1/4 (32)	B Back-to-Back S Single	630 Satin Stainless Steel 19 Matte black	

IN (MM), (†) CENTER-TO-CENTER.

NOT ALL COMBINATIONS OF STANDARD LENGTHS, TYPES & FINISHES ARE STOCKED. PLEASE REFER TO PRICE LIST OR CONTACT CANAROPA SALES AND SERVICE FOR DETAILS.



Single pulls are thru-bolt mounted with round end-caps

DIMENSIONS

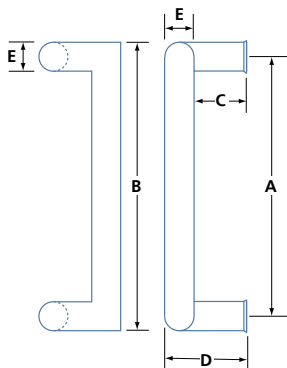

MODEL	A CENTER-TO-CENTER	B TOTAL LENGTH	C POSTS	D PROJECTION	E DIAMETER
20R10	10 (254)	11 1/4 (286)	2 7/16 (62)	3 11/16 (94)	1 1/4 (32)
20R24	24 (609.6)	25 1/4 (641)	2 7/16 (62)	3 11/16 (94)	1 1/4 (32)
20R36	36 (914.4)	37 1/4 (946)	2 7/16 (62)	3 11/16 (94)	1 1/4 (32)
20R48	48 (1219.2)	49 1/4 (1251)	2 7/16 (62)	3 11/16 (94)	1 1/4 (32)
20R60	60 (1524)	61 1/4 (1556)	2 7/16 (62)	3 11/16 (94)	1 1/4 (32)

IN (MM)



DOOR PULLS

GENERAL HARDWARE

DOREX 20T-E SERIES

OFFSET RECTANGULAR D-PULLS, MITERED, 1 1/4" x 3/4" DIAMETER



APPLICATIONS

- For wood or metal doors 1 3/8–2 1/4" (35–57 mm) thick
- For glass doors 5/16–1/2" (8–13 mm) thick

FEATURES

- 304 Stainless steel
- Available in paired or single pulls
- Single pulls are thru-bolt mounted with round end-caps
- All necessary mounting hardware included
- Matching washers for different finishes included
- Can be installed on 2" (51 mm) aluminum doors and frame with 1/2" (12.7 mm) door stop
- Packaged in an eco-friendly, fully recyclable, box



Single pulls are thru-bolt mounted with round end-caps

SELECTION GUIDE

SERIES	LENGTH [†]	DIMENSION	TYPE	FINISH	DESCRIPTION
20T	24	E	B	630	Offset Rectangular D-Pull, 1 1/4 x 3/4" (32 x 19 mm) Mitered, 24" Center-to-Center, Back-to-Back, Satin Stainless Steel
	10, 24, 36 48, 60	E 1-1/4 x 3/4 (32 x 19)	B Back-to-Back S Single	630 Satin Stainless Steel 19 Matte black	

IN (MM), (†) CENTER-TO-CENTER.

NOT ALL COMBINATIONS OF STANDARD LENGTHS, TYPES & FINISHES ARE STOCKED. PLEASE REFER TO PRICE LIST OR CONTACT CANAROPA SALES AND SERVICE FOR DETAILS.

DIMENSIONS

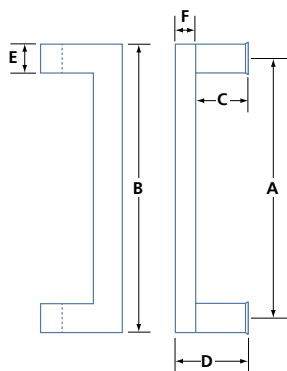

MODEL	A CENTER-TO-CENTER	B TOTAL LENGTH	C POSTS	D PROJECTION	E GRIP WIDTH	F GRIP HEIGHT
20T10	10 (254)	11 1/4 (286)	2 1/16 (68)	3 7/16 (87)	1 1/4 (32)	3/4 (19)
20T24	24 (609.6)	25 1/4 (641)	2 1/16 (68)	3 7/16 (87)	1 1/4 (32)	3/4 (19)
20T36	36 (914.4)	37 1/4 (946)	2 1/16 (68)	3 7/16 (87)	1 1/4 (32)	3/4 (19)
20T48	48 (1219.2)	49 1/4 (1251)	2 1/16 (68)	3 7/16 (87)	1 1/4 (32)	3/4 (19)
20T60	60 (1524)	61 1/4 (1556)	2 1/16 (68)	3 7/16 (87)	1 1/4 (32)	3/4 (19)

IN (MM)

DOOR PULLS

GENERAL HARDWARE

DOREX 18R-B SERIES

STRAIGHT ROUND PULLS, MITERED, $\frac{3}{4}$ " DIAMETER



APPLICATIONS

- For wood or metal doors & panels $1\frac{3}{8}$ – $2\frac{1}{4}$ " (35–57 mm) thick
- For glass doors $\frac{5}{16}$ – $\frac{1}{2}$ " (8–13 mm) thick
- Ideal for millwork/cabinet applications

FEATURES

- Stainless steel
- Available in paired or single pulls
- Single pulls are thru-bolt mounted with round end-caps
- All necessary mounting hardware included
- Washers included (clear plastic)



SELECTION GUIDE

SERIES	LENGTH [†]	DIAMETER	TYPE	FINISH	DESCRIPTION
18R	24	B	B	630	Straight Round Pull, $\frac{3}{4}$ " (19 mm) Mitered, 24" Center-to-Center, Back-to-Back, Satin Stainless Steel
	12, 16, 24	B $\frac{3}{4}$ (19)	B Back-to-Back S Single	630 Satin Stainless Steel 19 Matte black	

IN (MM), (†) CENTER-TO-CENTER.

NOT ALL COMBINATIONS OF STANDARD LENGTHS, TYPES & FINISHES ARE STOCKED. PLEASE REFER TO PRICE LIST OR CONTACT CANAROPA SALES AND SERVICE FOR DETAILS.



Single pulls are thru-bolt mounted with round end-caps



18R-BWBB-KIT-630 BOWL WASHERS

- Replaces included washers for an optional aesthetic look
- 2 Washers per kit

DIMENSIONS

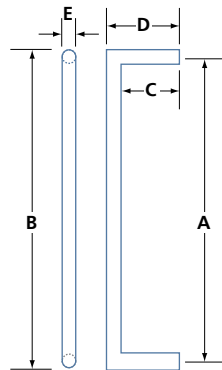

MODEL	A CENTER-TO-CENTER	B TOTAL LENGTH	C POSTS	D PROJECTION	E DIAMETER
18R12	$11\frac{13}{16}$ (300)	$12\frac{9}{16}$ (319)	$1\frac{3}{4}$ (44)	$2\frac{1}{2}$ (63.5)	$\frac{3}{4}$ (19)
18R16	$15\frac{3}{4}$ (400)	$16\frac{1}{2}$ (419)	$1\frac{3}{4}$ (44)	$2\frac{1}{2}$ (63.5)	$\frac{3}{4}$ (19)
18R24	$23\frac{5}{8}$ (600)	$24\frac{3}{8}$ (619)	$1\frac{3}{4}$ (44)	$2\frac{1}{2}$ (63.5)	$\frac{3}{4}$ (19)

IN (MM)



DOOR PULLS

GENERAL HARDWARE

DOREX 19R-B SERIES

LADDER ROUND PULLS, 3/4" DIAMETER



APPLICATIONS

- For wood or metal doors & panels 1 3/8–2 1/4" (35–57 mm) thick
- For glass doors 5/16– 1/2" (8–13 mm) thick
- Ideal for millwork/cabinet applications

FEATURES

- Stainless steel
- Available in paired or single pulls
- Single pulls are thru-bolt mounted with round end-caps
- All necessary mounting hardware included
- Washers included (clear plastic)



SELECTION GUIDE

SERIES	LENGTH†	DIAMETER	TYPE	FINISH	DESCRIPTION
19R	24	B	B	630	Ladder Pull, 3/4" (19mm) Round, 24" Center-to-Center, Back-to-Back, Satin Stainless Steel
	12, 16, 24	B 3/4 (19)	B Back-to-Back S Single	630 Satin Stainless Steel 19 Matte black	

IN (MM), †) CENTER-TO-CENTER.

NOT ALL COMBINATIONS OF STANDARD LENGTHS, TYPES & FINISHES ARE STOCKED. PLEASE REFER TO PRICE LIST OR CONTACT CANAROPA SALES AND SERVICE FOR DETAILS.



Single pulls are thru-bolt mounted with round end-caps



18R-BWBB-KIT-630 BOWL WASHERS

- Replaces included washers for an optional aesthetic look
- 2 Washers per kit

DIMENSIONS

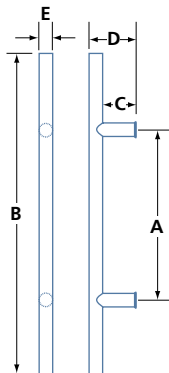

MODEL	A CENTER-TO-CENTER	B TOTAL LENGTH	C POSTS	D PROJECTION	E DIAMETER
19R12	11 13/16 (300)	17 3/4 (450)	1 3/4 (44)	2 1/2 (63.5)	3/4 (19)
19R16	15 3/4 (400)	21 5/8 (550)	1 3/4 (44)	2 1/2 (63.5)	3/4 (19)
19R24	21 5/8 (550)	27 9/16 (700)	1 3/4 (44)	2 1/2 (63.5)	3/4 (19)

IN (MM)

FLUSH PULLS

GENERAL HARDWARE

ARCHITECTURAL FLUSH PULLS

FP



FP414-60



FP410-135



FP412-135



FPC402-135



FP416-300



FPC406-300

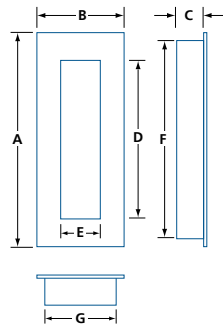

- For wood doors or panels
- Press fit mounting
- Stainless steel
- Available with or without spring cover

Dimensions for reference only.

Please request samples prior to door preparation.

MODEL	FINISH	A	B	C	D	E	F	G
FP410-135	-629,	5 ⁵ / ₁₆	2 ³ / ₄	1 ¹ / ₁₆	3 ¹⁵ / ₁₆	1	4 ¹⁵ / ₁₆	1 ¹³ / ₁₆
	-630	(135)	(70)	(17)	(100)	(25)	(125)	(46)
FP412-135	-629,	5 ⁵ / ₁₆	2 ³ / ₁₆	1 ¹ / ₁₆	3 ¹⁵ / ₁₆	1	4 ¹⁵ / ₁₆	1 ¹³ / ₁₆
	-630	(135)	(55)	(17)	(100)	(25)	(125)	(46)
FP414-60	-629,	2 ³ / ₈	2 ³ / ₈	1 ¹ / ₁₆	1 ³ / ₁₆	1 ³ / ₁₆	2	2
	-630	(60)	(60)	(17)	(30)	(30)	(50)	(50)
FP416-300	-629,	11 ¹³ / ₁₆	2 ³ / ₁₆	1 ¹ / ₁₆	1	1	10 ⁷ / ₈	1 ¹³ / ₁₆
	-630	(300)	(55)	(17)	(25)	(25)	(276)	(46)
WITH SPRING COVER								
FPC402-135*	-629,	5 ⁵ / ₁₆	2 ³ / ₁₆	1 ¹ / ₁₆	3 ¹⁵ / ₁₆	1	4 ¹⁵ / ₁₆	1 ¹³ / ₁₆
	-630	(135)	(55)	(17)	(100)	(25)	(125)	(46)
FPC406-300*	-629,	11 ¹³ / ₁₆	2 ³ / ₁₆	1 ¹ / ₁₆	9 ¹³ / ₁₆	1	10 ¹⁵ / ₁₆	1 ¹³ / ₁₆
	-630	(300)	(55)	(17)	(250)	(25)	(278)	(46)

IN (MM) (*) SPECIAL ORDER



FP224-70



FP224-110

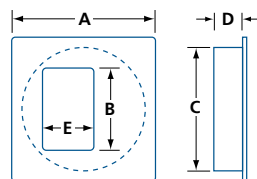

- For wood doors or panels
- Stainless steel
- Back-to-back mounting possible

Dimensions for reference only.

Please request samples prior to door preparation.

MODEL	FINISH	A	B	∅ C	D	E	F	G
FP224-70	-630	∅ 2 ³ / ₄ (70)	1 ¹ / ₂ (40)	2 ³ / ₈ (60)	5/8 (15)	1 (25)	—	—
FP224-110	-630	∅ 4 ⁵ / ₁₆ (110)	2 ¹¹ / ₁₆ (68)	4 (102)	5/8 (15)	1 ⁵ / ₁₆ (34)	—	—

IN (MM)

FLUSH PULLS

GENERAL HARDWARE

ARCHITECTURAL FLUSH PULLS

FP



FP231-180

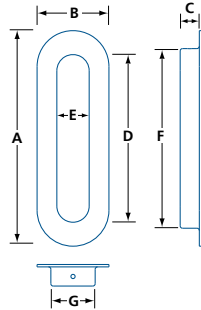

- For wood doors or panels
- Stainless steel
- Mounting screws included
- Back-to-back mounting possible

*Dimensions for reference only.
Please request samples prior to door preparation.*

MODEL	FINISH	A	B	C	D	E	F	G
FP231-180	-630	7 ³ / ₃₂ (180)	2 ³ / ₈ (60)	⁹ / ₁₆ (14)	5 ¹ / ₂ (140)	1 ¹ / ₁₆ (26)	5 ¹³ / ₁₆ (148)	1 ⁷ / ₁₆ (37)

IN (MM)



FP225-50

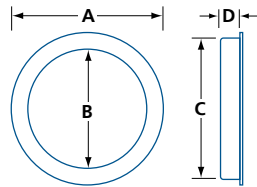

- For wood doors or panels
- Stainless steel
- Sizes 50 and 70 include mounting screws
- Back-to-back mounting possible

*Dimensions for reference only.
Please request samples prior to door preparation.*



FP225-70

MODEL	FINISH	∅ A	∅ B	∅ C	D	E	F	G
FP225-50	-630	2 (50)	1 ¹ / ₄ (31)	1 ⁹ / ₁₆ (40)	⁷ / ₁₆ (10.7)	—	—	—
FP225-70	-630, -19	2 ³ / ₄ (70)	2 (50)	2 ³ / ₈ (60)	¹ / ₂ (13.2)	—	—	—
FP225-110	-630	4 ⁵ / ₁₆ (110)	3 ³ / ₈ (86)	4 (102)	⁹ / ₁₆ (14)	—	—	—

IN (MM)



FP225-110



FLUSH PULLS

GENERAL HARDWARE

ARCHITECTURAL FLUSH PULLS

FP

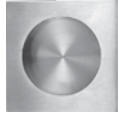

FP223R-64

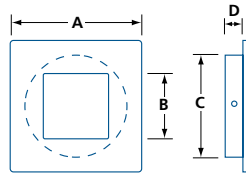

- For wood doors or panels
- Stainless steel
- Mounting screws included
- Back-to-back mounting possible

*Dimensions for reference only.
Please request samples prior to door preparation.*



FP223-70

MODEL	FINISH	A	B	∅ C	D	E	F	G
FP223R-64	-630, -19	2 1/2 (64)	1 3/4 (45)	2 1/8 (54)	1/2 (12.7)	—	—	—
FP223-50	-630, -19	2 (50)	1 (26)	1 9/16 (40)	7/16 (11.5)	—	—	—
FP223-70	-630, -19	2 3/4 (70)	1 9/16 (40)	2 3/8 (60)	1/2 (13.2)	—	—	—

IN (MM)



FP227-120



FP228-120

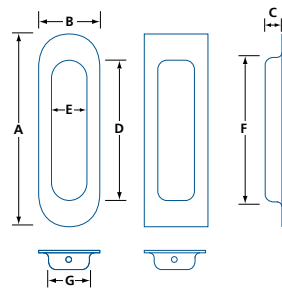

- For wood doors or panels
- Stainless steel
- Mounting screws included
- Back-to-back mounting possible

*Dimensions for reference only.
Please request samples prior to door preparation.*

MODEL	FINISH	A	B	C	D	E	F	G
FP227-120	-630, -19	4 11/16 (120)	1 5/8 (40)	7/16 (11)	3 5/16 (85)	7/8 (22)	3 5/8 (92)	1 1/16 (27)
FP228-120	-630, -19	4 11/16 (120)	1 5/8 (40)	7/16 (11)	3 5/16 (85)	7/8 (22)	3 5/8 (92)	1 1/16 (27)

IN (MM)



FP412-135B

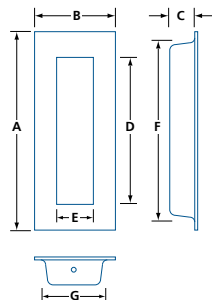

- For wood doors or panels
- Stainless steel
- Mounting screws included
- Back-to-back mounting possible

*Dimensions for reference only.
Please request samples prior to door preparation.*

MODEL	FINISH	A	B	C	D	E	F	G
FP412-135B	-630, -19	5 5/16 (135)	2 3/16 (55)	7/16 (11.5)	3 15/16 (100)	1 (25)	4 1/2 (114.5)	1 1/4 (32)

IN (MM)

FLUSH PULLS

GENERAL HARDWARE

MISCELLANEOUS FLUSH PULLS



2530C26

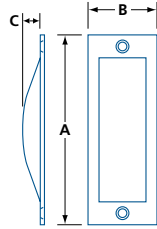

- For wood doors or panels
- Steel
- Wood screws included

MODEL	FINISH	A	B	C	CUT-OUT DIMENSION	/BOX
2530	BP, C15, C15A, C19, C26, CHR, C26D	4½ (114)	1⅝ (40)	½ (12.7)	1⅝ x 3½ x ½ (33.3 x 89 x 12.7)	50

IN (MM)



3503-26D

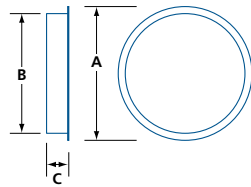

- For wood doors or panels
- Steel
- Fasteners NOT included

MODEL	FINISH	øA	øB	C	CUT-OUT DIMENSION	/BOX
3503	15, 19, 26, 26D	2⅞ (62)	2⅞ (53.5)	⅜ (9.5)	2⅞ DIA x ½ (54 DIA x 12.7)	150

IN (MM)



4100SS

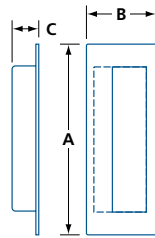

- For wood doors or panels
- Stainless steel
- Fasteners NOT included

MODEL	FINISH	A	B	C	CUT-OUT DIMENSION	/BOX
4100SS	Stainless steel	4½ (114)	1⅝ (40)	½ (12.7)	1⅝ x 3¾ x ⅝ (33.3 x 95 x 15.9)	25

IN (MM)



EDGE PULLS

GENERAL HARDWARE

EDGE PULLS

EP310, EP312, 3512

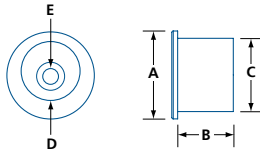

- For wood panels
- Stainless steel
- Wood screws included

MODEL	FINISH	MATERIAL	ø A	B	ø C	ø D	ø E
EP310-30	-630	Stainless Steel	1 ³ / ₁₆ (30)	¾ (19.5)	1 (25)	1 ³ / ₁₆ (20.5)	¾ (4.5)

IN (MM)

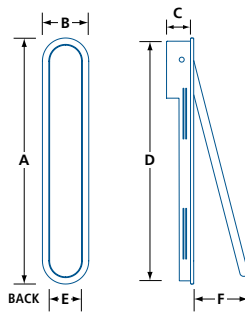

- For wood doors or panels
- Stainless steel

MODEL	FINISH	MATERIAL	A	B	C	D	E	F
EP312-154	-630	Stainless Steel	6 ³ / ₁₆ (158)	1 ³ / ₁₆ (30)	5/ ₈ (16)	5 ¹³ / ₁₆ (151)	1 (25)	3 ⁵ / ₁₆ (84)

IN (MM)

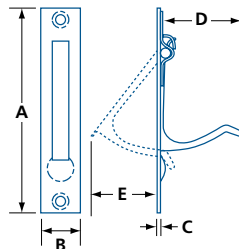

- For wood doors or panels
- Brass
- Wood screws included

MODEL	FINISH	MATERIAL	A	B	C	D	E	/BOX
3512	-32D	Brass	3 ⁷ / ₈ (98)	¾ (19.1)	5/ ₆₄ (2)	1 ⁹ / ₁₆ (39.6)	1 ¹ / ₄ (31.8)	25

IN (MM)

OTHER PULLS

GENERAL HARDWARE

BI-FOLD DOOR PULLS

3520, 3521

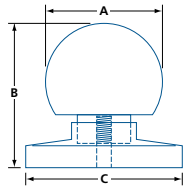

- For 1 $\frac{3}{8}$ " (35 mm) thick doors

MODEL	FINISH	MATERIAL	øA	B	øC	/BOX
3520	C3, C5, C15, C15A, C19, C26, C26D	Zinc die-cast	1 $\frac{1}{4}$ (31.8)	1 $\frac{5}{8}$ (41.3)	1 $\frac{3}{4}$ (44.5)	50

IN (MM)

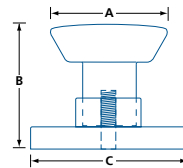

- For 1 $\frac{3}{8}$ " (35mm) thick doors

MODEL	FINISH	MATERIAL	øA	B	øC	D
3521	C15, C19, C26, C26D	Zinc die-cast	1 $\frac{1}{4}$ (31.8)	1 $\frac{1}{16}$ (17)	1 (25)	$\frac{3}{4}$ (20.5)

IN (MM)

MULTI-PURPOSE STEEL PULL

H2381CHR

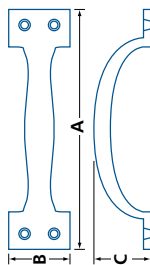

- Available in 3" (76 mm) and 8" (203 mm) lengths
- Fasteners not included

MODEL	FINISH	MATERIAL	A	B	C	/BOX
H2381CHR3	Chrome Plated	Steel	3 (76)	$\frac{3}{4}$ (19)	$\frac{3}{4}$ (19.1)	12
H2381CHR8	Chrome Plated	Steel	8 (203)	2 $\frac{1}{4}$ (57)	2 (50.8)	10

IN (MM)

OTHER PULLS

GENERAL HARDWARE

6½" MULTI-PURPOSE STEEL PULL

328ZP

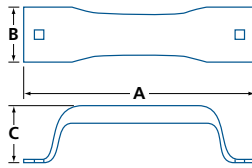

• Fasteners not included

MODEL	FINISH	MATERIAL	A	B	C	/BOX
328ZP	Zinc Plated	Steel	6¼ (159)	1½ (38.1)	1⅝ (41.3)	20

IN (MM)

SURFACE MOUNTED CHEST HANDLE

2535ZP

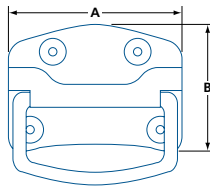

• Fasteners not included

MODEL	FINISH	MATERIAL	A	B	/BOX
2535ZP	Zinc Plated	Steel	4⅞ (105)	3⅞ (79)	20

IN (MM)



DOOR PULLS & PLATES

GENERAL HARDWARE

ALUMINUM DOOR PULL AND PLATE

H1410, H1411



H1410
H1411

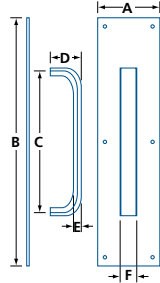

- Aluminum door pull and plate
- D-Type pull
- Handle available separately (with fasteners)
- Supplied with six # 6 x 3/4" (19.1 mm) long wood screws, two 1/4-20 UNC x 2 3/8" (60 mm) long machine screws and cup-washers

MODEL	FINISH	A	B	C	D	E	F	/CASE
H1410	Aluminum	4 (102)	16 (406)	9 (229)	2 (50.8)	15/32 (12)	1 1/16 (26.9)	32
H1411	Aluminum	3 1/2 (89)	15 (381)	7 (178)	2 (50.8)	15/32 (12)	1 1/16 (26.9)	40

IN (MM)

STAINLESS STEEL DOOR PULL AND PLATE

14R09P



14R09P-32D

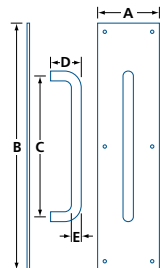

- Stainless steel door pull and plate
- Round pull
- Handle available separately (with fasteners)
- Supplied with six # 6 x 3/4" (19.1 mm) long wood screws, two 1/4-20 UNC x 2 3/8" (60 mm) long machine screws and cup-washers

MODEL	FINISH	A	B	C	D	E	/CASE
14R09P	32D	4 (102)	16 (406)	9 (229)	2 1/4 (57)	3/4 (19)	20

IN (MM)

DOOR PULLS & PLATES

GENERAL HARDWARE

ALUMINUM DOOR PULL

H1412, H1413



H1412
H1413

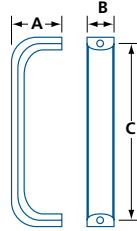

- Aluminum door pull
- D-Type pull
- Pull supplied with two 1/4-20 UNC x 2 3/8" (60 mm) long machine screws and cup-washers

MODEL	FINISH	A	B	C	/CASE
H1412	Aluminum	2 (50.8)	1 (25)	7 (178)	20
H1413	Aluminum	2 (50.8)	1 (25)	9 (229)	20

IN (MM)

STAINLESS STEEL DOOR PULL

14R09P



14R09-32D

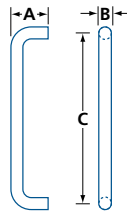

- Stainless steel door pull
- Round pull
- Pull supplied with two 1/4-20 UNC x 2 3/8" (60 mm) long machine screws and cup-washers

MODEL	FINISH	A	B	C	/CASE
14R09	32D	2 1/4 (57)	3/4 (19.1)	9 (229)	20

IN (MM)

PULL BACK PLATE

130315, 130416

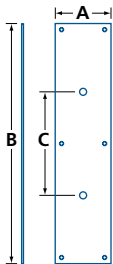

- Back plate for commercial pulls
- Mounting hardware included: wood screws

MODEL	FINISH	MATERIAL	A	B	C
130315	AL	Aluminum	3 1/2 (89)	15 (381)	7 (177.8)
130416	BP032	Brass	4 (102)	16 (406)	9 (228.6)

IN (MM)



PUSH & KICK PLATES

GENERAL HARDWARE

PUSH PLATES

1403, 1404, 1405



140315 AL

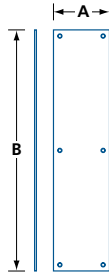

- Prevents damage caused by hands
- Recommended for high-traffic areas such as restaurants, restrooms, and other commercial and industrial areas
- Mounting hardware included: wood screws

MODEL	FINISH	MATERIAL	A	B
140315	AL	Aluminum	3½ (89)	15 (381)
	BP032	Brass		
140416	-32D	Stainless steel	4 (102)	16 (406)
140520	AL	Aluminum	5 (127)	20 (508)
	-32D	Stainless steel		

IN (MM)

KICK PLATES

1508, 1510, 1512



151234-32D

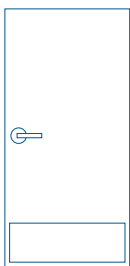
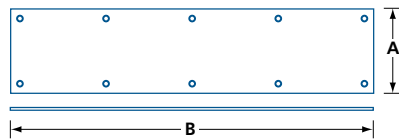

H = 8 to 12"
(203–305 mm)
W = [total width of the door]
– 1½" (38 mm)

- Prevents damage caused by feet
- Recommended for high-traffic areas such as restaurants, restrooms, and other commercial and industrial areas
- Mounting hardware included: wood screws

MODEL	FINISH	MATERIAL	A	B
150828			8 (203)	28½ (724)
150830			8 (203)	30½ (775)
150832	AL	Aluminum	8 (203)	32½ (826)
	BP032	Brass		
150834	-32D	Stainless steel	8 (203)	34½ (876)
150842			8 (203)	42½ (1080)
151028			10 (254)	28½ (724)
151030	AL	Aluminum	10 (254)	30½ (775)
151032	BP032	Brass	10 (254)	32½ (826)
	-32D	Stainless steel		
151034			10 (254)	34½ (876)
151234	AL	Aluminum	12 (305)	34½ (876)
	BP032	Brass		
	-32D	Stainless steel		

IN (MM)

KICK, PUSH & BACK PLATES

GENERAL HARDWARE

KICK PLATES

PKS, PKT



PKS0120-1034-32D

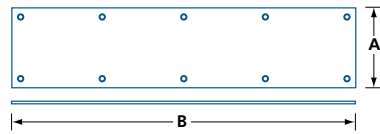

- Prevents damage caused by feet, mops, carts, or hand trucks
- Made with 201 Stainless Steel
- Two mounting methods available:
 - » PKS models include pre-drilled counter sunk holes and wood screws
 - » PKT models have no holes and include adhesive strips

MODEL	FINISH	MATERIAL	A	B
PKS0120-0834	32D	201 Stainless steel	8 (203)	34½ (876)
PKS0120-1034			10 (254)	34½ (876)
PKT0120-0834	32D	201 Stainless steel	8 (203)	34½ (876)
PKT0120-1034			10 (254)	34½ (876)

IN (MM)

PUSH PLATES

PPS, PPT

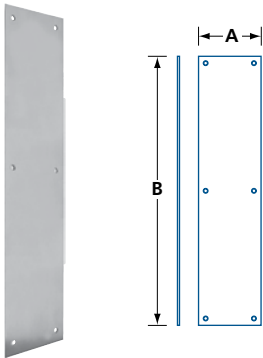

PPS0120-0416-32D

- Prevents damage caused by hands
- Recommended for high-traffic areas such as restaurants, restrooms, and other commercial and industrial areas
- Made with 201 Stainless Steel
- Two mounting methods available:
 - » PPS models include pre-drilled counter sunk holes and wood screws
 - » PPT models have no holes and include adhesive strips

MODEL	FINISH	MATERIAL	A	B
PPS0120-0416	32D	201 Stainless steel	4 (102)	16 (406)
PPT0120-0416			4 (102)	16 (406)

IN (MM)

PULL BACK PLATE

PBS

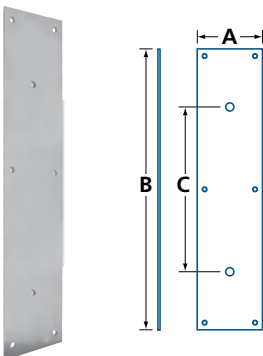

- Prevents damage caused by hands
- Recommended for high-traffic areas such as restaurants, restrooms, and other commercial and industrial areas
- Made with 201 Stainless Steel
- Pre-drilled holes for 9" (229mm) handle (sold separately)
- Includes pre-drilled counter sunk holes and wood screws for easy mounting

MODEL	FINISH	MATERIAL	A	B	C
PBS0120-0416	32D	201 Stainless steel	4 (102)	16 (406)	9 (229)

IN (MM)



FLOOR STOPS

GENERAL HARDWARE

DOMESTOP-LOW

T201



T200 C26D

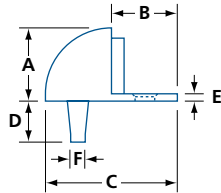

- For use with low or no threshold
- Heavy-duty zinc die-cast
- Non-marking rubber stop
- Mounting hardware included: wood screw and plastic anchor

- #T201 Riser allows easy conversion to threshold or carpet use

T201 C26D RISER



MODEL	FINISH	A	B	øC	D	E	øF	/BOX	/CASE
T200	C26D, C3, C4	1 (25.4)	7/8 (22.2)	1 3/4 (44.5)	3/4 (19.1)	3/32 (2.4)	3/16 (4.8)	10	200
T201	C26D	—	—	1 3/4 (44.5)	—	1/4 (6.4)	—	50	500

IN (MM)

DOMESTOP-HIGH

T218



T218 C26D

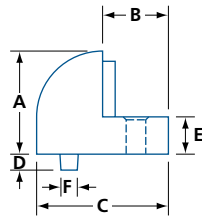

- For use with a threshold or undercut doors
- Heavy-duty zinc die-cast
- Non-marking rubber stop
- Includes wood screw and plastic anchor

MODEL	FINISH	A	B	øC	D	E	øF	/BOX	/CASE
T218	C26D, C3, C4	1 7/16 (36.5)	7/8 (22.2)	1 3/4 (44.5)	3/4 (19.1)	1/2 (12.7)	3/16 (4.8)	10	200

IN (MM)

DOMESTOP-UNIVERSAL

C229



C229 C26D

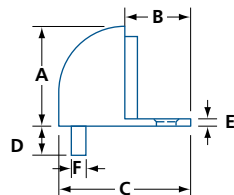

- For use with or without threshold
- Heavy-duty zinc die-cast
- Non-marking rubber stop
- Mounting hardware included: wood screw and plastic anchor

MODEL	FINISH	A	B	øC	D	E	øF	/BOX	/CASE
C229	C19, C26D	1 7/16 (36.5)	1 3/16 (20.6)	1 3/4 (44.5)	7/16 (11)	1/8 (3.2)	7/32 (5.6)	10	200

IN (MM)

FLOOR STOPS

GENERAL HARDWARE

SPRING STOP – UNIVERSAL

C230



C230-26D

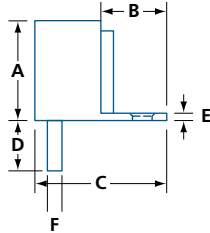

- For interior use with or without threshold
- Zinc die-cast body
- Spring loaded non-marking rubber stop
- Mounting hardware included: wood screw and anchor

MODEL	FINISH	A	B	øC	D	E	øF	/BOX
C230	19, 26D	1½ (38)	15/16 (24)	17/8 (47.4)	13/16 (21)	7/32 (6)	7/32 (5.6)	100

IN (MM)

FLOOR-MOUNTED DOOR STOP

R470, R471



R470C26D

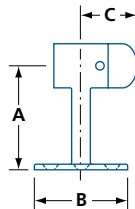

- For exterior / interior use
- Solid brass
- Non-marking rubber tip
- Mounting hardware included:
 - #R470 - wood screws
 - #R471 - lead shielding, masonry anchor, wood screws
 - #R470REP - Replacement rubber tip

MODEL	FINISH	A	øB	C	/BOX
R470	C10B, C26D, C3	2½ (64)	23/16 (56)	15/16 (33.3)	12
R471	C26D, C3	2½ (64)	23/16 (56)	15/16 (33.3)	12

IN (MM)



FLOOR STOPS

GENERAL HARDWARE

COLUMN DOOR STOP

3530



3530-26D

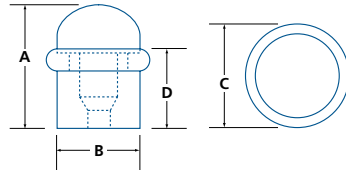

- For interior use
- Omni-directional stop
- Solid brass
- Mounting hardware included: wood screw with plastic anchor

MODEL	FINISH	A	øB	øC	D	/BOX
3530	26D, 19	1 ³ / ₄ (44.5)	1 ³ / ₁₆ (30.2)	1 ⁷ / ₁₆ (36.5)	1 ¹ / ₁₆ (28)	10

IN (MM)

COLUMN DOOR STOP

3531



3531-26D

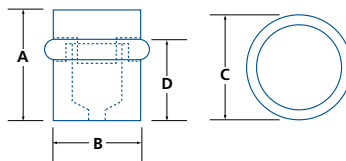

- For interior use
- Omni-directional stop
- Solid brass
- Mounting hardware included: wood and machine screws with masonry and plastic anchors

MODEL	FINISH	A	øB	øC	D	/BOX
3531	26D	1 ¹⁷ / ₃₂ (39)	1 ³ / ₁₆ (30.2)	1 ³ / ₈ (35)	1 ¹ / ₆₄ (29)	10

IN (MM)

COLUMN DOOR STOP

3532



3532-32D

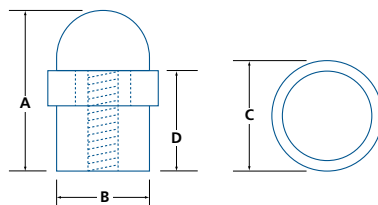

- For interior or exterior use
- Omni-directional stop
- Stainless steel
- Mounting hardware included: threaded bolt with masonry anchor

MODEL	FINISH	A	øB	øC	D	/BOX
3532	32D	2 (50.8)	1 ³ / ₁₆ (30.2)	1 ³ / ₈ (35)	1 ³ / ₈ (35)	10

IN (MM)

FLOOR STOPS

GENERAL HARDWARE

SQUARE DOOR STOP

3536



3536-630

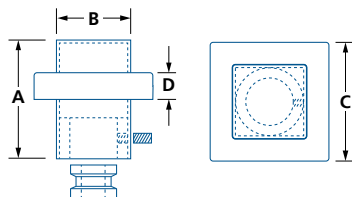

- For interior use
- Stainless steel, satin finish
- Mounting hardware included: wood screw and anchor

MODEL	FINISH	A	B	C	D	/UNIT
3536	630	1 ⁹ / ₁₆ (40)	1 (25)	1 ⁹ / ₁₆ (40)	⁹ / ₁₆ (14)	1

IN (MM)



WALL STOPS

GENERAL HARDWARE

FLEXIBLE WALL-MOUNTED DOOR STOPS

615, 3515, 3555



615C15



3515C15



3515C19



3555C15

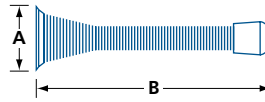

- For interior use
- Flexible steel spring
- Mounting hardware included: wood screw

MODEL	FINISH	ø A	B	/BOX	/CASE
615	C11P, C15, C15A, C3	$\frac{15}{16}$ (23.8)	3 (76)	50	600
3515	C11P, C15, C15A, C26, C26D, C3, C5	$\frac{15}{16}$ (23.8)	3 (76)	50	500
3515	C19	$\frac{15}{16}$ (23.8)	$\frac{39}{8}$ (86)	—	300
3555	C15	$\frac{11}{16}$ (26.9)	4 (102)	50	500

IN (MM)

RIGID WALL-MOUNTED DOOR STOP

692



692 BP



6131 C15

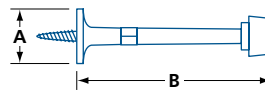

- For interior use
- Solid brass or zinc die-cast
- Integrated wood screw

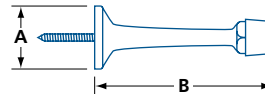

MODEL	FINISH	MATERIAL	ø A	B	/BOX	/CASE
692	BP	Zinc die-cast	$\frac{19}{16}$ (20.6)	$2\frac{7}{8}$ (73)	50	—
6131	C10B, C15, C15A, C19, C26, C26D, C3	Solid brass	1 (25.4)	3 (76)	25	250

IN (MM)

RIGID WALL-MOUNTED DOOR STOP - SQUARE

3538



3538-630

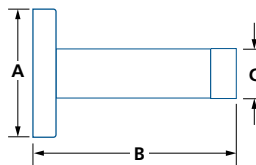

- For interior use
- Stainless steel, satin finish
- Concealed mounting screws
- Mounting hardware included: wood screw and plastic anchors

MODEL	FINISH	ø A	B	C	/UNIT
3538	630	$1\frac{27}{32}$ (46.5)	$3\frac{5}{32}$ (80)	$\frac{3}{4}$ (19)	1

IN (MM)

WALL STOPS

GENERAL HARDWARE

WALL-MOUNTED DOOR STOP

R474, R475

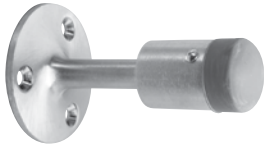

R474 C26D

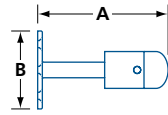

- For exterior / interior use
- Solid brass
- Non-marking rubber tip
- Mounting hardware included:
 - #R474 - wood screws
 - #R475 - lead shielding, masonry anchor, wood screws

#R470REP - Replacement rubber tip

MODEL	FINISH	A	ø B	/BOX
R474	C3, C26D	3½ (89)	2¾ (56)	12
R475	C26D	3½ (89)	2¾ (56)	12

IN (MM)

CONVEX & CONCAVE WALL-MOUNTED DOOR STOP

T231, T233



T231 C26D



T233 C26D

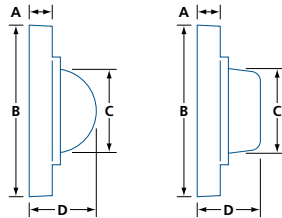

- Zinc die-cast
- Non-marking rubber
- Concealed mounting screws
- Mounting hardware included: wood screw, drywall anchors

MODEL	FINISH	A	ø B	ø C	D	/BOX	/CASE
T231	C19, C3, C26D	5/16 (7.9)	2½ (64)	1 1/16 (33.3)	1 (25.4)	25	250
T233	C19, C3, C26D	5/16 (7.9)	2½ (64)	1 1/16 (33.3)	1 (25.4)	25	250

IN (MM)

DOOR BUMPER

64BU

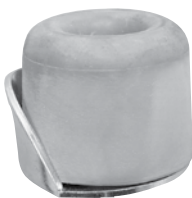

64BU

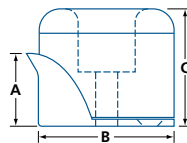

- Floor or wall mountable
- Non-marking rubber with steel support
- Mounting hardware included: wood screw

MODEL	FINISH	A	ø B	C	/BOX
64BU	Zinc plated	1 5/16 (23.8)	1 5/8 (41.3)	1 1/16 (33.3)	20

IN (MM)



ROLLER BUMPERS

GENERAL HARDWARE

ROLLER BUMPER STOP – OFFSET

RB300



RB300-26D

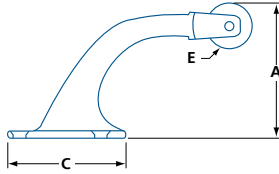

- Used to prevent damage when two doors open against each other
- Solid brass
- Arm offset (including roller): 2 3/4" (70 mm)
- Arm length (including base and roller): 5" (127 mm)
- Non-marking rubber roller
- Mounting hardware included: wood screws, plastic anchors

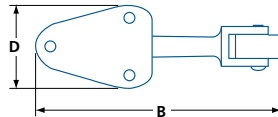
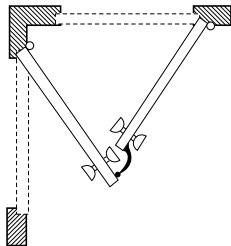

MODEL	FINISH	MATERIAL	A	B	C	D	øE	/BOX	/CASE
RB300	26D	Brass	2 3/4 (70)	5 (127)	2 1/4 (57)	1 3/4 (44)	15/16 (24)	10	100

IN (MM)

ROLLER BUMPER STOP - 4 1/2", 6"

RB400, RB600



RB400-26D

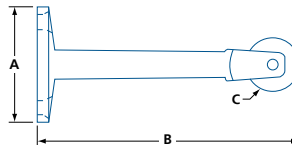

- Used to prevent damage when two doors meet each other at ~90deg (ie: back-to-back)
- Solid brass
- RB400 arm length (including roller): 4 1/2" (114 mm)
- RB600 arm length (including roller): 6" (152 mm)
- Non-marking rubber roller
- Mounting hardware included: wood screws, plastic anchors



RB600-26D

MODEL	FINISH	MATERIAL	A	B	ø C	/BOX	/CASE
RB400	26D	Brass	2 (50)	4 1/2 (114)	15/16 (24)	10	100
RB600	26D	Brass	2 (50)	6 (152)	15/16 (24)	8	80

IN (MM)

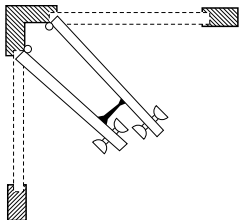

HINGE PIN STOPS

GENERAL HARDWARE

HINGE PIN STOPS

805, 3506



805

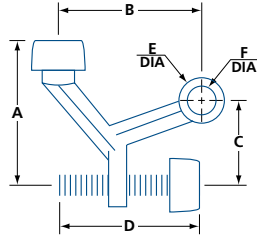

805

- For use on hinged doors
- Adjustable door opening angle
- Fits 1/4" (6 mm) diameter hinge pin

3506

- For use on hinged doors
- Adjustable door opening angle
- Removable nylon bushing
- Fits 1/4" (6 mm) or 5/16" (7.5 mm) diameter hinge pins

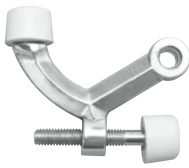

3506C15

MODEL	FINISH	A	B	C	D	øE	øF	/BOX
805	Brass plated	1 5/8 (41.3)	1 5/8 (41.3)	1 1/8 (28.6)	1 5/8 (41.5)	1/2 (13)	1/4 (6.4)	25
3506	C3, C11P, C15, C15A, C26D	1 5/8 (41.3)	2 (50.8)	1 1/8 (28.6)	1 15/16 (49.2)	9/16 (14.7)	1/4 OR 5/16* (6.4 OR 7.5)	25

IN (MM) (*) REMOVE BUSHING FOR LARGER DIAMETER

HINGE PIN STOP – PIVOTING SHOE

3507

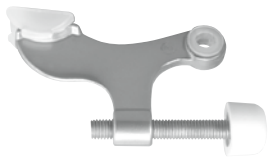

3507C15

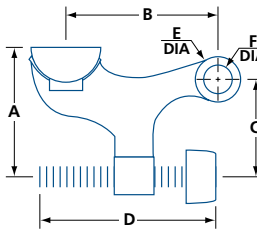

- For use on hinged doors
- Adjustable door opening angle
- Removable nylon brushing
- Fits 1/4" (6 mm) or 5/16" (7.5 mm) diameter hinge pins
- Zinc die-cast body
- Self-pivoting shoe

MODEL	FINISH	A	B	C	D	øE	øF	/BOX
3507	C3, C11P, C15, C15A, C26D	1 7/16 (36.5)	1 7/8 (47.6)	1 1/8 (28.6)	2 (50.8)	1/2 (13)	1/4 OR 5/16* (6.4 OR 7.5)	50

IN (MM) (*) REMOVE BUSHING FOR LARGER DIAMETER

HINGE PIN STOP

3508

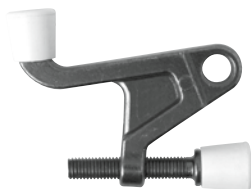

3508C15A

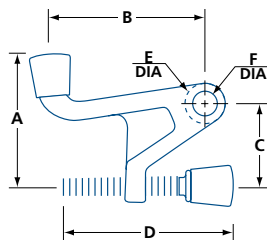

- For use on hinged doors
- Adjustable door opening angle
- Zinc die-cast body
- Removable nylon brushing
- Fits 1/4" (6 mm) or 5/16" (7.5 mm) diameter hinge pins

MODEL	FINISH	A	B	C	D	øE	øF	/BOX
3508	C15A, C26D	1 7/16 (36.5)	1 7/8 (47.6)	1 1/4 (31.8)	1 15/16 (49.2)	1/2 (13)	1/4 OR 5/16* (6.4 OR 7.5)	50

IN (MM) (*) REMOVE BUSHING FOR LARGER DIAMETER

HINGE PIN STOPS

GENERAL HARDWARE

HINGE PIN STOP – HEAVY DUTY

3509



3509

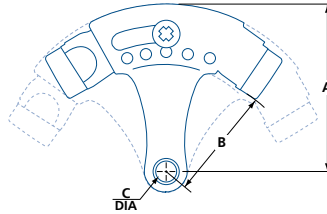

- For use on hinged doors
- Positive slip-proof adjustment
- 95 - 130° door opening adjustment
- Fits both $\frac{1}{4}$ " (6 mm) and $\frac{3}{16}$ " (8 mm) diameter hinge pins
- All steel construction
- Non-marring rubber tips

MODEL	FINISH	A	B	ϕ C	/BOX
3509	C11P, C15, C15A, C19, C26D	$2\frac{1}{16}$ (52)	$1\frac{1}{2}$ (38)	$\frac{1}{4}$ (6.2)	25

IN (MM)



DOOR STOPS WITH HOLDER

GENERAL HARDWARE

FLOOR-MOUNTED DOOR STOP

R472, R473



R472 C26D

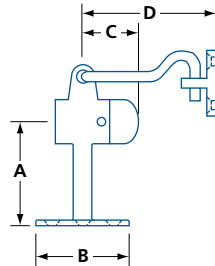

- For exterior / interior use
- Solid brass
- Non-marking rubber tip
- Mounting hardware included:
 - #R472 - wood screws
 - #R473 - lead shielding, masonry anchor, wood screws
- #R470REP - Replacement rubber tip

MODEL	FINISH	A	øB	C	D	/BOX
R472	C26D, C3	2½ (64)	2¾/16 (56)	1¾/16 (33.3)	2¾/4 (70)	10
R473	C26D, C3	2½ (64)	2¾/16 (56)	1¾/16 (33.3)	2¾/4 (70)	10

IN (MM)

HEAVY DUTY FLOOR-MOUNTED STOP WITH HOOK

DC540



DC540

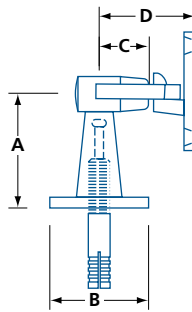

- For heavy-duty interior / exterior use
- Heavy-duty zinc die-cast
- Non-marking rubber tip
- Concealed mounting
- Mounting hardware included:
 - #DC540 - masonry anchor, wood screws
 - #DC540W - wood screws
- #DC540REP - Replacement rubber tip

MODEL	FINISH	A	øB	C	D	/BOX
DC540	Satin chrome	2 (50.8)	1¾/4 (44.5)	1¾/32 (28)	1¾/4 (44.5)	10
DC540W	Satin chrome	2 (50.8)	1¾/4 (44.5)	1¾/32 (28)	1¾/4 (44.5)	10

IN (MM)

DOOR STOPS WITH HOLDER

GENERAL HARDWARE

WALL-MOUNTED DOOR STOP

R476, R477



R476 C26D

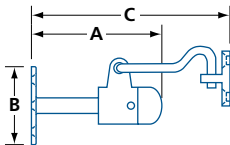

- For exterior / interior use
- Solid brass
- Non-marking rubber tip
- Mounting hardware included:
 - #R476 - wood screws
 - #R477 - lead shielding, masonry anchor, wood screws

#R470REP - Replacement rubber tip

MODEL	FINISH	A	øB	C	/BOX
R476	C3, C26D	3½ (89)	2¾ (56)	5¼ (133.4)	12
R477	C26D	3½ (89)	2¾ (56)	5¼ (133.4)	12

IN (MM)

HEAVY-DUTY WALL-MOUNTED DOOR STOP WITH HOOK

DCX20



DCX20

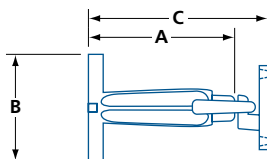

- For heavy-duty interior / exterior use
- Heavy duty zinc die-cast
- Non-marking rubber tip
- Conceal mounting
- Mounting hardware included: masonry anchors, machine screws

MODEL	FINISH	A	øB	C
DCX20	Satin chrome	4⅞ (124)	3½ (89)	5¾ (146)

IN (MM)



DOOR HOLDERS

GENERAL HARDWARE

FRICITION DOOR HOLDER – WALL MOUNTED

DC23D

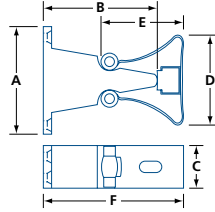
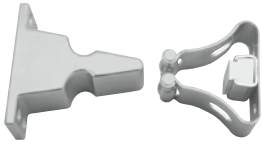

- For interior use
- Zinc die-cast, steel clamp
- Mounting hardware included: wood screws

MODEL	FINISH	A	B	C	D	E	F
DC23D	Zinc Plated	2 ⁵ / ₈ (67)	2 ⁹ / ₁₆ (65)	1 (25.4)	2 ¹ / ₈ (54)	1 ¹⁵ / ₁₆ (49)	3 ¹ / ₈ (79)

IN (MM)

FRICITION DOOR HOLDER - FLOOR MOUNTED

DC24D

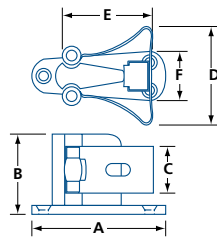

- For interior use
- Zinc die-cast, steel clamp
- Mounting hardware included: wood screws

MODEL	FINISH	A	B	C	D	E	F
DC24D	Satin Chrome	2 ¹⁵ / ₁₆ (75)	1 ³ / ₄ (44.5)	1 ⁹ / ₁₆ (23.8)	2 ¹ / ₈ (54)	1 ¹⁵ / ₁₆ (54)	1 ¹ / ₈ (28.6)

IN (MM)

DOOR HOLDERS

GENERAL HARDWARE

PLUNGER TYPE DOOR HOLDER

1014.02



1014.02

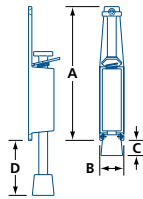

- Heavy duty zinc die-cast
- Non-marking rubber tip

#1024.00 - Replacement rubber tip for #1014.02
 #1015REP - Replacement rubber tip for #1015.02

MODEL	FINISH	A	B	C	D	/BOX
1014.02	Silver Paint	4 ³ / ₄ (121)	1 (25.4)	3 ⁵ / ₈ (9.5)	1 ⁵ / ₈ (41.3)	6
1015.02	Silver Paint	6 ¹ / ₂ (165)	1 ³ / ₁₆ (30.2)	7 ¹ / ₁₆ (11.1)	2 ³ / ₈ (60)	6

IN (MM)

PLUNGER TYPE DOOR HOLDER

1024.02

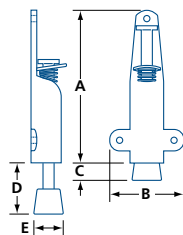

- Steel construction
- Non-marking rubber tip

#1024.00 - Replacement rubber tip

MODEL	FINISH	A	B	C	D	E
1024.02	Silver Paint	4 ³ / ₈ (111)	2 ¹ / ₈ (54)	1 ¹ / ₁₆ (17.5)	1 ³ / ₄ (44.5)	7 ⁷ / ₈ (22.2)

IN (MM)

PLUNGER TYPE DOOR HOLDER

1026.02

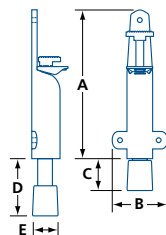

- Steel construction
- Non-marking rubber tip

#1026.00 - Replacement rubber tip

MODEL	FINISH	A	B	C	D	E
1026.02	Silver Paint	6 ³ / ₄ (172)	2 ¹ / ₂ (63.5)	1 ¹ / ₂ (38.1)	2 ³ / ₄ (70)	1 ¹ / ₈ (28.6)

IN (MM)



DOOR HOLDERS

GENERAL HARDWARE

KICK-DOWN DOOR HOLDERS

1060, 1076, 659-660, 17, 18-5



1060.02



1076.02



659-660

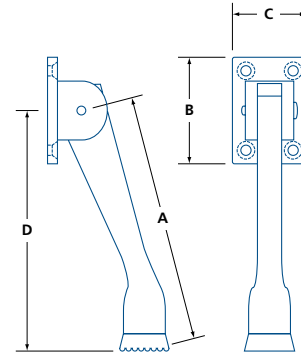

MODEL	FINISH	MATERIAL	A	B	C	D	REPLACEMENT TIP	SCREWS*	/BOX
1060.02	Silver Paint	Zinc die-cast	5 (127)	4 (102)	1 (25.4)	4 ⁷ / ₈ (124)	—	—	8
1076.02	Silver Paint	Steel	4 ¹ / ₄ (108)	2 ³ / ₈ (60)	1 ³ / ₁₆ (20.6)	4 ¹ / ₄ (108)	#1076.00	—	10
659-660	Satin Stainless Steel	Brass	4 ¹ / ₁₆ (103)	2 (50.8)	1 ³ / ₈ (34.9)	3 ³ / ₄ (95.25)	—	—	50

IN (MM) (*) SCREWS NOT INCLUDED



17 C26D



18-5 C26D

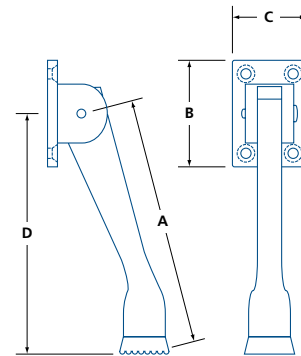

MODEL	FINISH	MATERIAL	A	B	C	D	REPLACEMENT TIP	SCREWS*	/BOX
17	C3, C26D	Zinc die-cast	5 (127)	2 (50.8)	1 ³ / ₈ (34.9)	4 ³ / ₄ (121)	#17REP	Wood	10
18-5	C20D, C26D	Brass	5 (127)	2 (50.8)	1 ³ / ₈ (34.9)	4 ³ / ₄ (121)	#18REP	Wood	12

IN (MM) (*) SCREWS INCLUDED

DOOR HOLDERS

GENERAL HARDWARE

KICK-DOWN DOOR HOLDER

604, 606, 608, 610, 612



MODEL	FINISH	MATERIAL	A	B	C	D	REPLACEMENT TIP	SCREWS*	/BOX
604	C2G, C3	Steel	4 (102)	3 (76)	1 $\frac{5}{8}$ (41.3)	3 $\frac{7}{8}$ (98)	#208G	Wood	10
606	C2G, C3	Steel	6 (152)	3 (76)	1 $\frac{5}{8}$ (41.3)	5 $\frac{7}{8}$ (149)	#208G	Wood	10
608	C2G	Steel	8 (203)	3 (76)	1 $\frac{5}{8}$ (41.3)	7 $\frac{7}{8}$ (200)	#208G	Wood	10
610	C2G	Steel	10 (254)	3 (76)	1 $\frac{5}{8}$ (41.3)	9 $\frac{3}{4}$ (248)	#208G	Wood	10
612	C2G	Steel	12 (305)	3 (76)	1 $\frac{5}{8}$ (41.3)	11 $\frac{3}{4}$ (298)	#208G	Wood	10

IN (MM) (*) SCREWS INCLUDED



DOOR HOLDERS

GENERAL HARDWARE

MAGNETIC DOOR HOLDER AND STOP

CH401

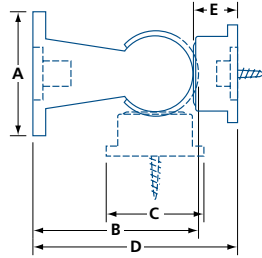

- Quality nylon construction
- Floor or wall mountable
- Concealed mounting
- Mounting hardware included: wood screw, masonry nail

MODEL	FINISH	A	B	C	D	E	/CASE
CH401	B, AW	2 ¹ / ₈ (54)	2 ⁷ / ₈ (73)	1 ¹¹ / ₁₆ (42.9)	3 ¹ / ₂ (89)	³ / ₄ (19.1)	10

IN (MM)

MAGNETIC DOOR HOLDER AND STOP

MDH, SMDH



SOSS

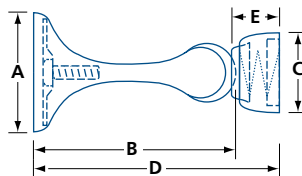

- Floor or wall mountable
- Zinc die-cast material
- Spring loaded stop
- Concealed mounting
- Mounting hardware included: wood screws

MODEL	FINISH	A	B	C	D	E	/CASE
MDH	C15, C19, C26D, C3	1 ³ / ₄ (44.5)	3 (76)	1 ³ / ₁₆ (30)	3 ⁵ / ₈ (93)	³ / ₄ (19)	10
SMDH	C15, C19, C26D, C3	1 ³ / ₄ (44.5)	3 (76)	1 ³ / ₁₆ (30)	3 ⁵ / ₈ (93)	³ / ₄ (19)	10

IN (MM)

MDH C26D

CHECK CHAINS

GENERAL HARDWARE

CHECK CHAINS

3548, 3550

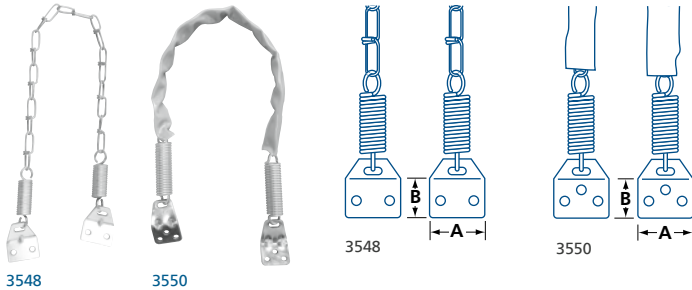

- Prevents damage to the door or door hardware from wind gusts
- For screen doors and/or storm doors
- Steel chain
- Two tension coil springs
- Stamped steel mounting brackets, zinc plated
- Mounting hardware included: wood screws

#3550 - Includes grey vinyl cover

MODEL	FREE LENGTH	MAX DOOR WIDTH	A	B	PER BOX
3548	25½ (648)	36 (914)	1¾ (30)	¾ (19)	25
3550	27½ (698.5)	42 (1067)	1¼ (31.8)	1⅛ (28.5)	10

IN (MM)

COMMERCIAL CHECK CHAINS

3560, 3561

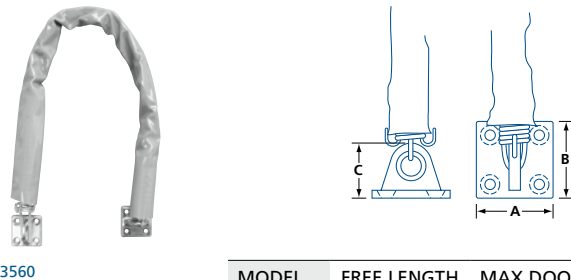

- Prevents damage to door and/or door hardware from wind gusts
- For commercial or heavy duty doors
- Heavy-duty welded chain
- Two assembled compression coil springs at both end
- Zinc die-cast mounting brackets, zinc plated
- Grey vinyl cover
- Mounting hardware included: wood screws

MODEL	FREE LENGTH	MAX DOOR WIDTH	A	B	C	PER BOX
3560	25 (635)	36 (914)	1½ (38)	1½ (38)	1⅛ (28.6)	6
3561	32 (813)	42 (1067)	1½ (38)	1½ (38)	1⅛ (28.6)	6

IN (MM)

HEAVY DUTY COMMERCIAL CHECK CHAIN

3562

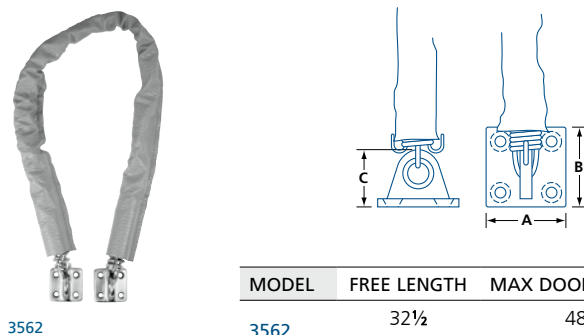

- Prevents damage to door and/or door hardware from wind gusts
- For commercial or heavy duty doors exposed to high or frequent wind gusts
- Extra heavy-duty welded chain
- Two heavy-duty coil springs with stainless steel linkage
- Brass die-cast mounting brackets, satin chrome finish
- Grey textured vinyl cover
- Mounting hardware included: wood screws

MODEL	FREE LENGTH	MAX DOOR WIDTH	A	B	C	PER BOX
3562	32½ (825.5)	48 (1219)	1¾ (39.7)	1¾ (39.7)	1¾ (30.2)	6

IN (MM)

MAIL SLOTS

GENERAL HARDWARE

DraftGuard INSULATED MAIL SLOT – DELUXE

46100, 46200

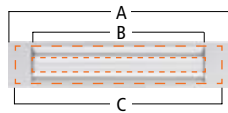

	46100	46200
(A) Front	12 ⁷ / ₃₂ x 3 ⁹ / ₃₂ (310 x 80)	15 ³ / ₄ x 3 ⁹ / ₃₂ (400 x 80)
(B) Slot Size	9 ⁹ / ₃₂ x 1 ³ / ₁₆ (236 x 30)	12 ¹⁹ / ₁₆ x 1 ³ / ₁₆ (325 x 30)
(C) Door cut-out	11 ¹³ / ₁₆ x 2 ³ / ₄ (300 x 70)	15 ¹ / ₁₆ x 2 ³ / ₄ (389 x 70)

IN (MM)

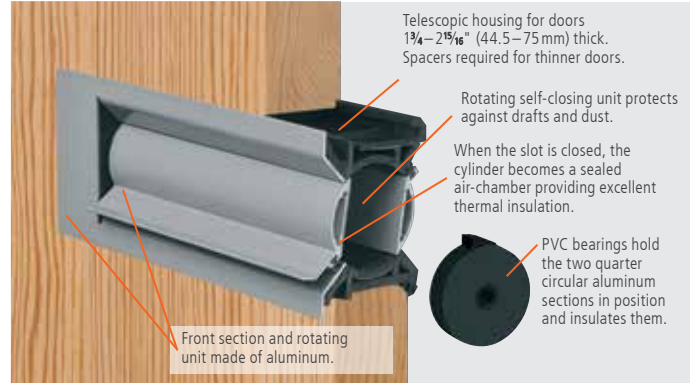

- Fully insulated housing; with rotating self-closing aluminum flaps
- Fully enclosed air chamber stops drafts, dust and reduces noise
- Telescopic housing for doors 1³/₄–2¹⁵/₁₆" (44.5–75 mm) thick Spacers required for thinner doors (see below)
- Available in wide format to accommodate large envelopes
- Soft rubber weather exterior seal
- Insulating gaskets in all critical areas





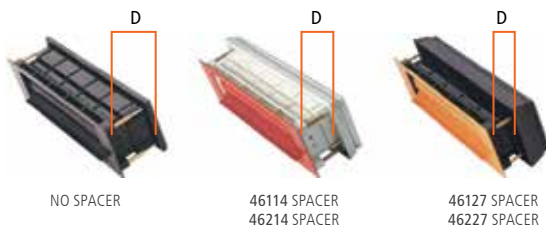



FRAME SPACERS

For doors less than 1³/₄in (44.5mm) thick.



THICKNESS (D)	46100	46200
1 ³ / ₄ – 2 ¹⁵ / ₁₆ (44.5–75)	—	—
1 ³ / ₁₆ – 2 ¹³ / ₃₂ (30–61)	#46114BLACK #46114WHITE	#46214BLACK #46214WHITE
2 ¹ / ₃₂ – 1 ⁷ / ₈ (17–48)	#46127BLACK #46127WHITE	#46227BLACK #46227WHITE

IN (MM)

-  #461001 Anodized satin silver with black frame and housing
#462001 (wide format)
-  #461004 Anodized medium bronze with black frame and housing
#462004 (wide format)
-  #461005 Anodized dark bronze with black frame and housing
#462005 (wide format)
-  #461006 Anodized brass with black frame and housing
#462006 (wide format)
-  #461007 Powder coated white with white frame and housing
#462007 (wide format)
-  #461010 Powder coated black with black frame and housing
#462010 (wide format)
-  #461011 Anodized satin nickel with black frame and housing
#462011 (wide format)
-  #461012 Matte black with black frame and housing
#462012 (wide format)

(*) OTHER COLOURS / FINISHES AVAILABLE BY SPECIAL ORDER.
PLEASE CONTACT YOUR LOCAL REPRESENTATIVE

MAIL SLOTS

GENERAL HARDWARE

DraftGuard INSULATED MAIL SLOT

46500

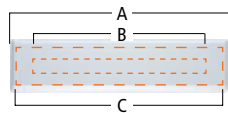
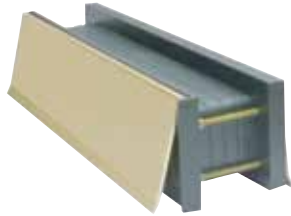

	REGULAR	WITH EXTENSION*
(A) Front	11 $\frac{7}{8}$ x 2 $\frac{3}{4}$ (302 x 70)	—
(B) Slot Size	10 x 1 $\frac{1}{2}$ (254 x 38)	—
(C) Door cut-out	11 $\frac{1}{8}$ x 2 (280 x 51)	11 $\frac{1}{4}$ x 2 (286 x 51)

IN (MM) (*) EXTENSION MUST BE USED WITH DOORS OVER 1 $\frac{3}{4}$ IN (44.5 MM) THICK AND SLOT MUST BE CUT WITH FINE-TOOTH SAW.

- Self-closing interior and exterior anodized aluminum flaps
- Fully enclosed tough plastic housing
- Telescopic housing for doors up to 1 $\frac{3}{4}$ " (44.5 mm) thick
- Up to 4 $\frac{1}{4}$ " (108 mm) with extension (sold separately)
- Soft rubber weather exterior seal
- Insulating gaskets in all critical areas



#465001..... Aluminum

#465005..... Dark Bronze

#465006..... Brass

#465007..... White



#465000..... Slot extension.
For doors 1 $\frac{3}{4}$ –4 $\frac{1}{4}$ " (44.5–108 mm)

#465000L..... Screw pack for slot extension

#465000R..... Replacement screws for mail slot



SIGNAGE

GENERAL HARDWARE

PICTOGRAM SIGNAGE – SMALL

S801, S802, S803, S804

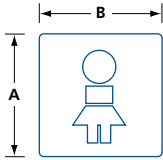

- Stainless steel pictogram signs
- Self-adhesive
- Packaged & sold individually

MODEL	DESCRIPTION	A	B
S801-630	Women		
S802-630	Men	2 ¹⁵ / ₁₆	2 ¹⁵ / ₁₆
S803-630	Unisex	(75)	(75)
S804-630	Disabled		

IN (MM)

PICTOGRAM SIGNAGE

S901, S902, S903, S904

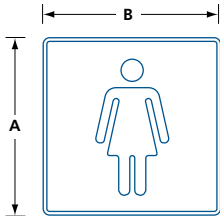

- Stainless steel pictogram signs
- Plastic mounting plate
- Packaged & sold individually
- Wood screws included

MODEL	DESCRIPTION	A	B
S901-630	Women		
S902-630	Men	6 ⁷ / ₁₆	6 ⁷ / ₁₆
S903-630	Unisex	(164)	(164)
S904-630	Disabled		

IN (MM)

DOOR SWEEPS

GENERAL HARDWARE

DOREX DOOR SWEEP WITH NYLON BRUSH

DGS-WAD

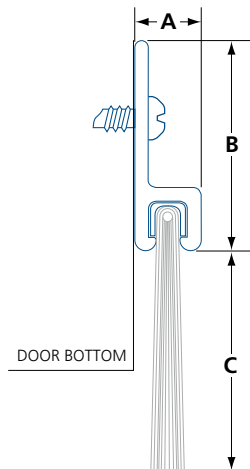

- cULus listed (UL10C)
 - » Wood fire door: 20 min
 - » Composite fire door: 90 min
 - » Metal fire door: 3 hrs
- Surface mounted
- Reduces infiltration of drafts, moisture, air, insects, and dust
- Extruded aluminum profile
- Flexible nylon brush conforms to surface irregularities
- Remains flexible between -40 to 205°C (-40 to 401°F)
- Can be cut to required length
- Includes screws for wood and metal doors

MODEL	FINISH	A	B	C	LENGTH
DGS-WAD380B-36	Mill Aluminum	1/4 (6.4)	7/8 (22.2)	1 (25.4)	36 (914)
DGS-WAD380B-48					48 (1219)
DGS-WDD380B-36	Dark Bronze	(6.4)	(22.2)	(25.4)	36 (914)
DGS-WDD380B-48					48 (1219)

IN(MM)

DOREX DOOR SWEEP WITH NYLON BRUSH AND RAIN DRIP

DGS-WAR

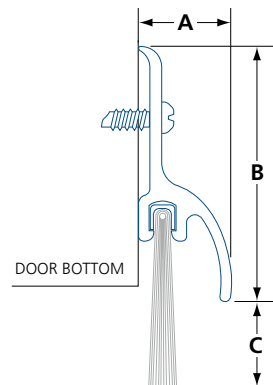

- cULus listed (UL10C)
 - » Wood fire door: 20 min
 - » Composite fire door: 90 min
 - » Metal fire door: 3 hrs
- Surface mounted
- Reduces infiltration of drafts, moisture, air, insects, and dust
- Rain drip deflects water and prevents seepage through the gap under doors
- Extruded aluminum profile
- Flexible nylon brush conforms to surface irregularities
- Remains flexible between -40 to 205°C (-40 to 401°F)
- Can be cut to required length
- Includes screws for wood and metal doors

MODEL	FINISH	A	B	C	LENGTH
DGS-WAR480B-36	Mill Aluminum	1/2 (12.7)	1 1/4 (31.8)	3/8 (9.5)	36 (914)

IN(MM)

DOOR SWEEPS

GENERAL HARDWARE

DOREX DOOR SWEEP WITH NEOPRENE SEAL

DGS-WA210, WD210

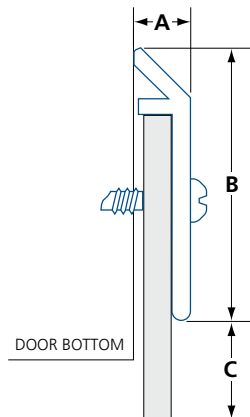

- cULus listed (UL10C)
 - » Metal fire door: 3 hrs
- Surface mounted
- Reduces infiltration of drafts, moisture, air, insects, and dust
- Extruded aluminum profile
- Neoprene blade
- Remains flexible between -20 to 50°C (-4 to 122°F)
- Can be cut to required length
- Includes screws for metal doors

MODEL	FINISH	A	B	C	LENGTH
DGS-WA210N-36	Mill Aluminum	1/4 (6.34)	1 1/4 (31.8)	9/16 (14.3)	36 (914)
DGS-WA210N-48					48 (1219)
DGS-WD210N-36	Dark Bronze	1/4 (6.34)	1 1/4 (31.8)	9/16 (14.3)	36 (914)
DGS-WD210N-48					48 (1219)

IN(MM)



DOOR BOTTOMS

GENERAL HARDWARE

DOREX AUTOMATIC DOOR BOTTOMS, HOLLOW METAL DOORS

DGS-BA32V

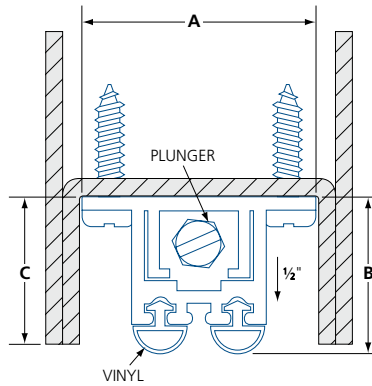

- cULus listed (UL10C)
 - » Wood fire door: 20 min
 - » Composite fire door: 90 min
 - » Metal fire door: 3 hrs
- Automatic door bottom for hollow metal doors with inverted channel
- Door seal will lower automatically as the door closes
- Extruded aluminum rail
- Non handed
- Maximum drop: $\frac{1}{2}$ " (12.7 mm), recommended gap is $\frac{3}{8}$ " (9.5 mm)
- Door thickness: $1\frac{3}{4}$ " (44.5 mm)
- Channel depth: $\frac{3}{4}$ " (19 mm)
- Dual vinyl gaskets provide an excellent general-purpose seal
- Door drop can accommodate even and uneven surfaces
- Can be trimmed
- Does not include end-caps, requires a hole for the plunger to extend through the hinge side of the door edge
- Includes screws for metal doors

MODEL	FINISH	A	B	C	LENGTH
DGS-BA32V-36	Anodized Aluminum	$1\frac{3}{8}$ (34.9)	$1\frac{5}{16}$ (23.8)	$\frac{3}{4}$ (19)	36 (914)

IN(MM)

DOREX AUTOMATIC DOOR BOTTOMS, WOOD DOORS

DGS-BA50N

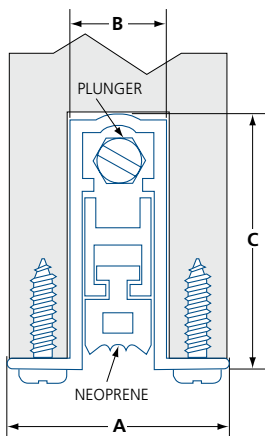

- cULus listed (UL10C)
 - » Wood fire door: 20 min
 - » Composite fire door: 90 min
 - » Metal fire door: 3 hrs
- Automatic door bottom for wood door and mortised channel
- Door seal will lower automatically as the door closes
- Extruded aluminum rail
- Non handed
- Maximum drop: $\frac{3}{4}$ " (19 mm)
- Door thickness: $1\frac{3}{8}$ – $1\frac{3}{4}$ " (35–44.5 mm)
- Recommended channel depth: $1\frac{1}{2}$ " (38 mm), width: $1\frac{9}{32}$ " (15 mm)
- Neoprene gasket provides an excellent general-purpose seal
- Door drop can accommodate even and uneven surfaces
- Can be trimmed
- Includes endcaps and screws for metal and wood doors
- On fire doors, the door bottom mortise preparation must be done by the door manufacturer

MODEL	FINISH	A	B	C	LENGTH
DGS-BA50N-36	Anodized Aluminum	$1\frac{5}{16}$ (33)	$\frac{9}{16}$ (14.2)	$1\frac{7}{16}$ (36.6)	36 (914)

IN(MM)

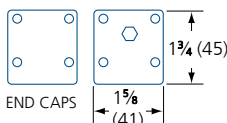

PERIMETER GASKETS

GENERAL HARDWARE

DOREX PERIMETER GASKETING

DGS-SA14V



- cULus listed (UL10C)
 - » Wood fire door: 20 min
 - » Composite fire door: 90 min
 - » Metal fire door: 3 hrs

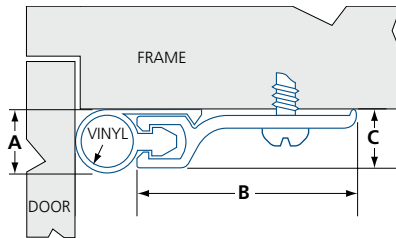

- Surface mounted
- For use on a wood or metal door frame of a 3x7ft (91.4x213.4cm) door
- For gaps between 1/16–1/4" (2–6 mm)
- Temperature range: -35 to 120°C (-31 to 248°F)
- Extruded aluminum profile
- Vinyl gasket, provides an excellent general-purpose seal
- Can be installed on the face of a door to fill gaps between paired doors
- Slotted holes for easy adjustment
- Can be cut to required length
- Includes screws for wood and metal door frames
- Supplied in 3 pieces: 2x7 ft (213.4 cm), 1x3 ft (91.4 cm)

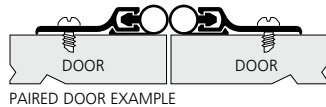

MODEL	FINISH	A ¹	B	C	LENGTH
DGS-SA14V-17	Mill Aluminum	1/4 (6.4)	7/8 (22.2)	1/4 (6.4)	204 (5080)

IN(MM) (1) NON-COMPRESSED

DOREX ADHESIVE GASKETING

DGS-SB12S



- cULus listed (UL10C)
 - » Wood fire door: 20 min
 - » Composite fire door: 90 min
 - » Metal fire door: 3 hrs

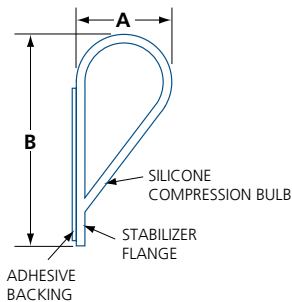

- Silicone gasket with permanent adhesive strip
- Surface mounted
- For use on wood or metal door frames
- Compresses to fill gaps between 1/16–1/4" (2–6 mm)
- Provides an excellent general-purpose seal
- Extruded high-temperature silicone, self-extinguishing and non-toxic
- Effective between -50 to 232°C (-58 to 450°F)
- Impervious to fungus, mold, and mildew
- Unaffected by sunlight, ozone, and ultraviolet rays
- Coil length of 17ft (50.8cm) is sufficient for a door frame for a 3x7ft (91.4x213.4cm) door
- Can be cut to required length
- Other lengths available by special order

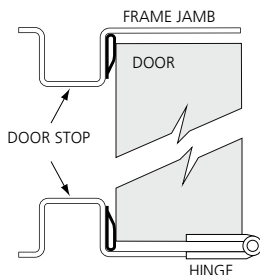

MODEL	FINISH	A ¹	B	LENGTH ²
DGS-SB12S-17	Black	1/4 (6.4)	1/2 (12.7)	204 (5080)

IN(MM) (1) NON-COMPRESSED (2) COIL LENGTH



DOOR ASTRAGAL

GENERAL HARDWARE

DOREX T-ASTRAGAL

DGS-AA158V



- cULus listed (UL10C)
 - » Metal fire door: 3 hrs
- Surface mounted on the beveled door edge of the active door of paired doors
- Provides a general-purpose weather seal
- Extruded aluminum profile
- Eco-friendly, bio-based gasket
- Can be cut to required length
- Includes screws for wood and metal door frames
- Door coordinator may be required when using two active doors
- Temperature range -5 to 60°C (-23 to 140°F)

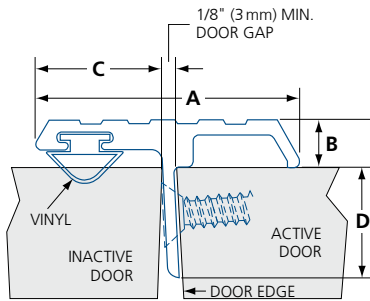

MODEL	FINISH	A	B	C	D	LENGTH
DGS-AA158V-7	Mill Aluminum	1 ³ / ₈ (35)	1/4 (6.4)	2 ¹ / ₃₂ (16.8)	9/16 (14.5)	84 (2134)

IN(MM)

FLUSH BOLTS

GENERAL HARDWARE

MANUAL EXTENSION FLUSH BOLT – FIRE RATED

FBUL100

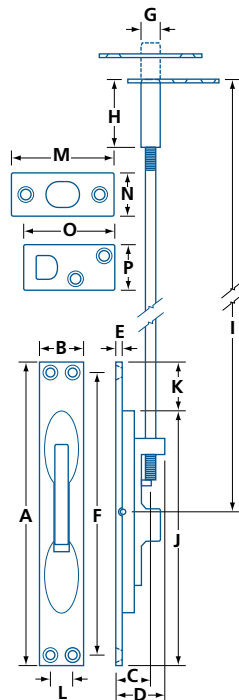

- cULus listed for use with hollow metal, metal clad, steel covered composite, flush type sheet or metal swinging type fire doors.
- Not for wood fire doors
- Fits metal door preparation per ANSI A115.4-206
- Brass and steel components
- Throw: 3/4" (19mm)
- Adjustable rod up to 7/8" (22.2mm)
- Supplied with guide, strike plate and 12" (305mm) 1/4-20 UNC threaded rod (see dimension "I")
- Mounting hardware included: combination machine-wood screws
- Optional rods available (not pictured):
 #FBUL100R16 18" (457.2mm) optional threaded rod
 #FBUL100R22 24" (609.6mm) optional threaded rod

MODEL	FINISH	A	B	C	D	E	F	G	H	I	J	K	L	M	N	O	P
FBUL100	15, 26D 19	6 3/4 (171)	1 (25.4)	3/4 (19.1)	1 (25.4)	1/8 (3.2)	6 1/4 (158.8)	1/2 (12.7)	1 1/2 (38.1)	12 (305)	5 3/4 (146)	1 (25.4)	1/2 (12.7)	2 1/4 (57)	1 5/16 (23.8)	2 (50.8)	1 (25.4)

IN (MM)

FLUSH BOLTS

GENERAL HARDWARE

MANUAL EXTENSION FLUSH BOLT

DC840, 8402

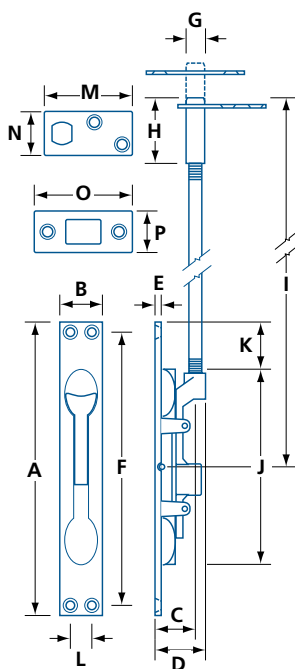
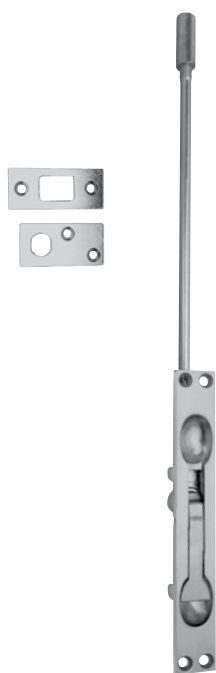

- Supplied with guide, strike plate and 12" (305mm) $\frac{1}{16}$ -18 UNC threaded rod
- Fits metal door preparation per ANSI A115.4-1981
- Zinc-diecast and steel components
- Mounting hardware included: machine and wood screws

#DC840 has a $\frac{5}{8}$ " (15.9mm) throw and $+\frac{5}{8}$ " (15.9mm) adjustment

#8402 has a $\frac{1}{2}$ " (12.7mm) throw and $\pm\frac{1}{4}$ " (6.4mm) adjustment

MODEL	FINISH	A	B	C	D	E	F	G	H	I	J	K	L	M	N	O	P	/UNIT
DC840	C3, C15	6 $\frac{3}{4}$ (171)	1 (25.4)	$\frac{3}{4}$ (19.1)	1 (25.4)	$\frac{9}{64}$ (3.6)	6 $\frac{1}{4}$ (158.8)	$\frac{7}{16}$ (11.1)	1 $\frac{1}{2}$ (38.1)	12 (305)	4 $\frac{3}{4}$ (111)	1 (25.4)	$\frac{1}{2}$ (12.7)	2 (50.8)	1 (25.4)	2 $\frac{1}{4}$ (57)	1 $\frac{5}{16}$ (23.8)	2
8402	C3, C5, C10B, C26D	6 $\frac{3}{4}$ (171)	1 (25.4)	$\frac{3}{4}$ (19.1)	1 (25.4)	$\frac{9}{64}$ (3.6)	6 $\frac{1}{4}$ (158.8)	$\frac{1}{2}$ (12.7)	1 $\frac{1}{2}$ (38.1)	12 (305)	4 $\frac{9}{16}$ (116)	1 (25.4)	$\frac{1}{2}$ (12.7)	2 (50.8)	1 (25.4)	2 $\frac{1}{4}$ (57)	1 $\frac{5}{16}$ (23.8)	2

IN (MM)



FLUSH BOLTS

GENERAL HARDWARE

MANUAL EXTENSION FLUSH BOLT

DC860, DC861

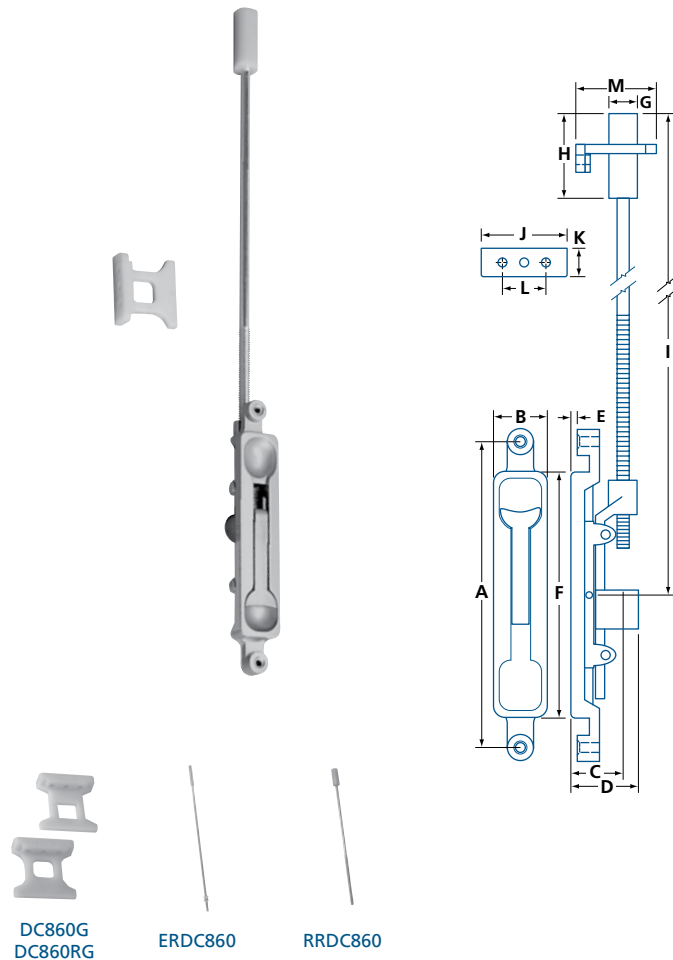

- Single bolt for aluminum doors
- $\frac{1}{8}$ " (3 mm) or $\frac{1}{4}$ " (6 mm) offset
- Throw: $\frac{5}{8}$ " (16 mm)
- Flush bolt faceplate with $\frac{5}{32}$ " (4 mm) radius corners
- Zinc die-cast and steel components
- Mounting hardware included: machine screws
- Supplied with threaded adaptor bushing and locking nuts
- Supplied with:
 - #RRDC860 12" (305 mm) Replacement rod
 - #ERDC860 12" (305 mm) $\frac{1}{4}$ -20 UNC extension rod
 - #DC860G / #DC860RG Nylon guides

MODEL	FINISH	A	B	C	D	E	F	G	H	I	J	K	L	M	/BOX
DC860	C20D, C28	$5\frac{1}{4}$ (133)	$1\frac{5}{16}$ (23.8)	$1\frac{3}{16}$ (20.6)	$1\frac{1}{8}$ (28.6)	$\frac{1}{8}$ (3.2)	$4\frac{1}{4}$ (108)	$\frac{1}{2}$ (12.7)	$1\frac{1}{2}$ (38)	12 (305)	$1\frac{1}{2}$ (38)	$\frac{1}{2}$ (12.7)	$\frac{3}{4}$ (19.1)	$1\frac{3}{8}$ (34.9)	10
DC861	C20D, C28	$5\frac{1}{4}$ (133)	$1\frac{5}{16}$ (23.8)	$1\frac{3}{16}$ (20.6)	$1\frac{1}{8}$ (28.6)	$\frac{1}{4}$ (6.2)	$4\frac{1}{4}$ (108)	$\frac{1}{2}$ (12.7)	$1\frac{1}{2}$ (38)	12 (305)	$1\frac{1}{2}$ (38)	$\frac{1}{2}$ (12.7)	$\frac{3}{4}$ (19.1)	$1\frac{3}{8}$ (34.9)	10

IN (MM)

FLUSH BOLTS

GENERAL HARDWARE

AUTOMATIC EXTENSION FLUSH BOLT

FB610M

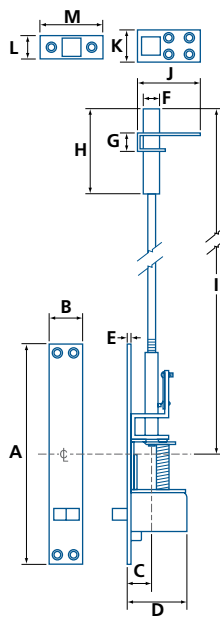

- cULus labeled and rated only for hollow metal doors up to and including 3 hrs. Conforms to UL 10C and UBC 7-2-1997
- Top and bottom flush bolts for use on metal doors measuring up to 4 ft. (1219mm) wide and 8 ft. (2438mm) high
- Fits standard and ANSI preparation for metal doors
- Steel components
- Fully automatic, when active door is opened, inactive door is free
- Maintains inactive door locked in case of fire
- Supplied with bolt guide and door strike
- Mounting hardware included: machine and combination Machine-wood screws

MODEL	FINISH	A	B	C	D	E	F	G	H	I	J	K	L	M
FB610M	32D	6 ³ / ₄ (171)	1 (25.4)	3 ⁴ / ₄ (19.1)	1 ⁷ / ₈ (47.6)	1 ¹ / ₈ (3.2)	1 ¹ / ₂ (12.7)	5 ⁵ / ₈ (15.9)	2 (50.8)	12 (305)	2 (50.8)	1 (25.4)	1 (25.4)	2 ¹ / ₄ (57)

IN (MM)



FLUSH BOLTS

GENERAL HARDWARE

6" BRASS FLUSH BOLT

8123, 8124

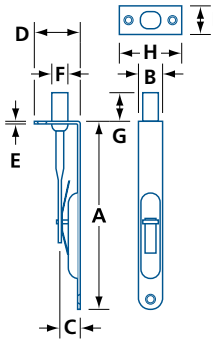

8123

- Made of solid brass and steel materials
- Flush bolt face plate end with $\frac{3}{8}$ " (9.5 mm) radius
- Keeper included
- Mounting hardware included: wood screws

MODEL	FINISH	VAR	A	B	C (BS)	D	E	øF	G	H	I	/BOX
8123	C11P	-1	6 (152)	$\frac{3}{4}$ (19.1)	$\frac{1}{2}$ (12.7)	$1\frac{1}{4}$ (31.6)	$\frac{5}{64}$ (2)	$\frac{1}{2}$ (12.7)	1 (25.4)	2 (50.8)	$\frac{7}{8}$ (22.2)	25
8123	C19	-2	$5\frac{7}{8}$ (149.3)	$\frac{3}{4}$ (19.1)	$\frac{1}{2}$ (12.7)	$1\frac{1}{4}$ (31.6)	$\frac{5}{64}$ (2)	$\frac{1}{2}$ (12.7)	1 (25.4)	2 (50.8)	$\frac{7}{8}$ (22.2)	25
8123	C15, C26D	-2	$5\frac{7}{8}$ (149.3)	$\frac{3}{4}$ (19.1)	$\frac{1}{2}$ (12.7)	$1\frac{1}{4}$ (31.6)	$\frac{5}{64}$ (2)	$\frac{1}{2}$ (12.7)	1 (25.4)	2 (50.8)	$\frac{7}{8}$ (22.2)	25

IN (MM)

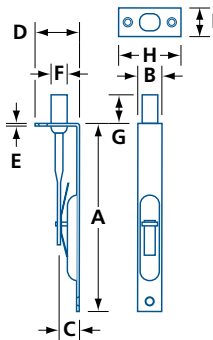

8124

- Made of solid brass and steel materials
- Keeper included
- Mounting hardware included: wood screws

MODEL	FINISH	A	B	C (BS)	D	E	øF	G	H	I	/BOX
8124	C26, C3	6 (152)	$\frac{3}{4}$ (19.1)	$\frac{1}{2}$ (12.7)	$1\frac{1}{4}$ (32)	$\frac{5}{64}$ (2)	$\frac{1}{2}$ (12.7)	1 (25.4)	2 (50.8)	$\frac{7}{8}$ (22.2)	25

IN (MM)

FLUSH BOLTS

GENERAL HARDWARE

4" BRASS FLUSH BOLT

8125

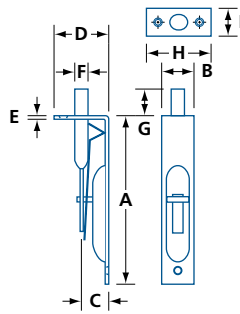

- Made of solid brass and steel materials
- Keeper included
- Mounting hardware included: wood screws

MODEL	FINISH	A	B	C (BS)	D	E	øF	G	H	I	/BOX
8125	C26	4 (102)	¾ (19.1)	1 15/32 (11.9)	1 3/16 (30.2)	5/64 (2)	5/16 (7.9)	19/16 (20.6)	1 1/2 (38.1)	5/8 (15.9)	20

IN (MM)

DUST PROOF STRIKE

T840

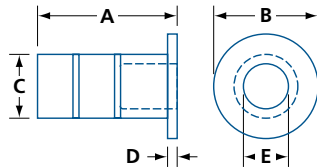

- Aluminum
- Spring loaded plunger
- Strike engagement depth up to 3/4" (19mm)

MODEL	FINISH	MATERIAL	A	øB	øC	D	øE	/BOX
T840	C28	Aluminum	1 1/8 (48)	1 3/8 (35)	27/32 (21.4)	1/8 (3.2)	9/16 (14.3)	25

IN (MM)

DUST PROOF STRIKE

DPS, DPSL

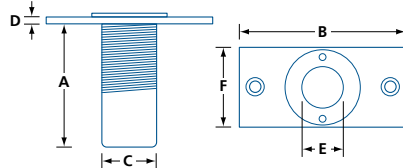
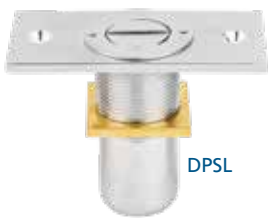

- Stainless steel
- Spring loaded plunger
- Strike engagement depth up to 3/4" (19mm)
- Accepts 5/8" (16mm) diameter bolts
- Includes wood screws, plastic anchors
- Includes adjustment tool
- Available with locking (#DPSL) or non-locking (#DPS) plunger

MODEL	FINISH	MATERIAL	A	B	øC	D	øE	F	/BOX	/CASE
DPS/ DPSL	15, 26D	Stainless steel	2 (51)	2 7/8 (73)	3 1/32 (25)	1/8 (3.2)	3/4 (19)	1 3/8 (35)	10	100

IN (MM)



SURFACE BOLTS

GENERAL HARDWARE

BRASS SURFACE BOLT

F779

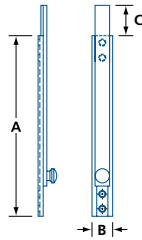

- Two keepers included
- Mounting hardware included: wood screws

MODEL	FINISH	SIZE	MATERIAL	A	B	C	/BOX
F779	C3, C11P, C15, C15A, C19, C26D	4	Brass	4 (102)	1 ¹ / ₁₆ (17.5)	7/ ₈ (22.2)	30

IN (MM)

8" COMMERCIAL SURFACE BOLT

0831

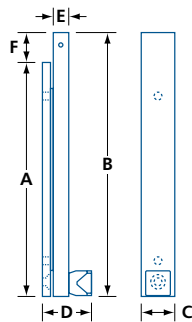

- UL listed
- Both top and bottom strikes included
- Mounting hardware included: wood screws and machine screws

MODEL	FINISH	MATERIAL	A	B	C	D	E	F
0831	Satin chrome	Steel	7 (178)	8 (203)	1 (25.4)	1 ¹ / ₂ (38.1)	1/2 (12.7)	1 (25.4)

IN (MM)

CHAIN BOLT

66

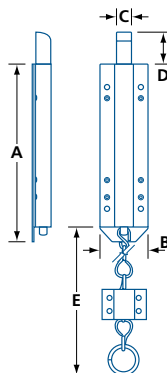

- Heavy-duty chain bolt
- Spring loaded
- Bolt reversible for in-swing and out-swing doors

MODEL	FINISH	MATERIAL	A	B	C SQ	D	E
66	Black	Steel	7 ³ / ₈ (187)	2 (50.8)	5/ ₈ (15.9)	1 ⁵ / ₁₆ (33.3)	22 (559)

IN (MM)

SURFACE BOLTS

GENERAL HARDWARE

FOOT BOLT

68

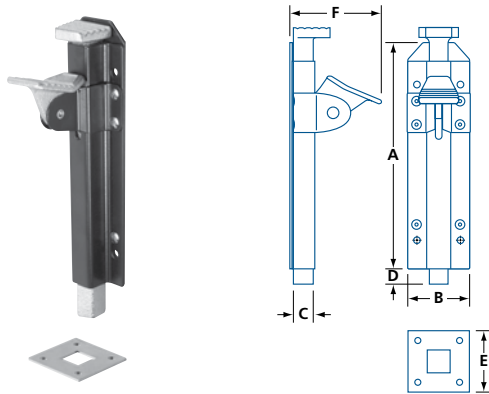

- Cast iron bolt

MODEL	FINISH	MATERIAL	A	B	C SQ	D	E SQ	F
68	Black	Steel	7 ³ / ₈ (187)	2 (50.8)	5 ⁵ / ₈ (15.9)	1 (25.4)	2 (50.8)	2 ⁷ / ₈ (73)

IN (MM)

12" CANE BOLT – HEAVY DUTY

1069

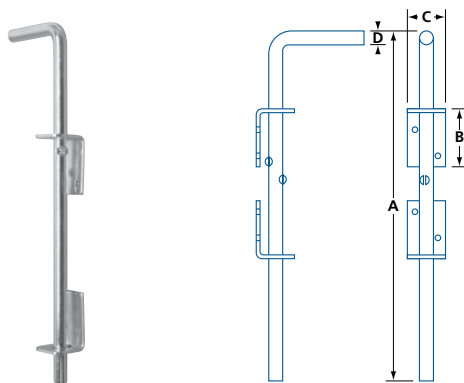

- Mounting hardware included: wood screws

MODEL	FINISH	MATERIAL	A	B	C	D
1069	Zinc plated	Steel	12 (305)	2 (50.8)	1 ⁵ / ₁₆ (33.3)	1 ⁵ / ₃₂ (11.9)

IN (MM)



TOWER & BARREL BOLTS

GENERAL HARDWARE

TOWER BOLT

9234

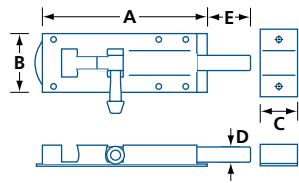

- Steel bolt with groove
- Groove holds bolt in position when installed vertically. Prevents bolt from being shaken loose.

MODEL	FINISH	MATERIAL	A	B	C	∅D	E	/BOX
9234	Epoxy black	Steel	4 $\frac{1}{8}$ (105)	1 $\frac{1}{2}$ (38.1)	1 (25.4)	2 $\frac{5}{64}$ (10)	1 $\frac{1}{4}$ (31.8)	10
9236	Epoxy black	Steel	6 $\frac{1}{8}$ (156)	1 $\frac{1}{2}$ (38.1)	1 (25.4)	2 $\frac{5}{64}$ (10)	1 $\frac{1}{4}$ (31.8)	10
9238	Epoxy black	Steel	8 $\frac{1}{8}$ (206)	1 $\frac{3}{4}$ (44.5)	1 $\frac{3}{8}$ (34.9)	$\frac{1}{2}$ (12.7)	1 $\frac{5}{8}$ (41.3)	10
92310	Epoxy black	Steel	10 $\frac{1}{8}$ (257)	1 $\frac{3}{4}$ (44.5)	1 $\frac{3}{8}$ (34.9)	$\frac{1}{2}$ (12.7)	1 $\frac{5}{8}$ (41.3)	10

IN (MM)

STEEL BARREL BOLT

0711

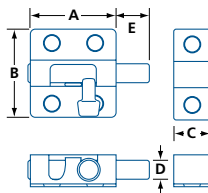
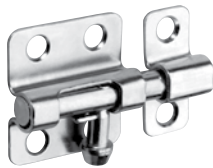

- Mounting hardware included: wood screws

MODEL	FINISH	MATERIAL	A	B	C	∅D	E	/BOX
0711ZP2	Zinc plated	Steel	1 $\frac{3}{8}$ (34.9)	1 $\frac{7}{16}$ (36.5)	$\frac{5}{8}$ (15.9)	$\frac{5}{16}$ (7.9)	$\frac{9}{16}$ (14.3)	20
0711ZP25	Zinc plated	Steel	1 $\frac{3}{4}$ (44.5)	1 $\frac{7}{16}$ (36.5)	$\frac{5}{8}$ (15.9)	$\frac{5}{16}$ (7.9)	$\frac{5}{8}$ (15.9)	12
0711ZP3	Zinc plated	Steel	2 $\frac{1}{8}$ (54)	1 $\frac{7}{16}$ (36.5)	$\frac{5}{8}$ (15.9)	$\frac{5}{16}$ (7.9)	$\frac{3}{4}$ (19.1)	12
0711ZP4	Zinc plated	Steel	3 (76)	1 $\frac{1}{2}$ (38.1)	$\frac{5}{8}$ (15.9)	$\frac{5}{16}$ (7.9)	1 (25.4)	10
0711ZP5	Zinc plated	Steel	3 $\frac{3}{4}$ (95)	1 $\frac{1}{2}$ (38.1)	$\frac{5}{8}$ (15.9)	$\frac{5}{16}$ (7.9)	1 (25.4)	12
0711ZP6	Zinc plated	Steel	4 $\frac{5}{8}$ (117)	1 $\frac{1}{2}$ (38.1)	$\frac{5}{8}$ (15.9)	$\frac{5}{16}$ (7.9)	1 (25.4)	12

IN (MM)

PADBOLTS

GENERAL HARDWARE

STANDARD PADBOLTS

1068, 7210

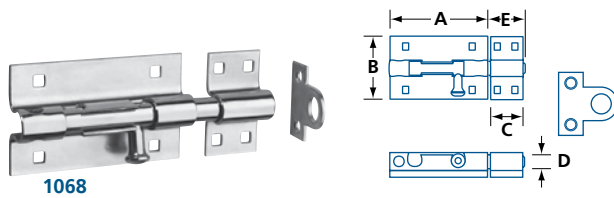

1068

1068

- Durable steel construction
- Includes 2 different bolt keepers
- Accepts shackles up to $\frac{3}{8}$ " (9.5mm)
- $1\frac{3}{4}$ " (45mm) throw
- Mounting hardware included: wood screws

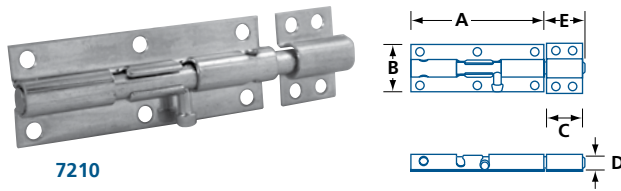

7210

7210

- Durable steel construction
- Accepts shackles up to $\frac{1}{4}$ " (6.4mm)
- $1\frac{1}{4}$ " (32mm) throw
- Mounting hardware included: wood screws

MODEL	FINISH	MATERIAL	A	B	C	∅D	E	MAX PADLOCK SHACKLE DIA	/BOX
GUARD 1068ZP6	Zinc plated	Steel	4½ (114)	2 ¹¹ / ₁₆ (68)	1½ (38.1)	¹⁹ / ₃₂ (15.1)	1 ¹³ / ₁₆ (46)	³ / ₈ (9.5)	5
GUARD 1068ZP8	Zinc plated	Steel	6 (152)	2 ⁵ / ₈ (67)	1½ (38.1)	¹⁹ / ₃₂ (15.1)	1 ¹³ / ₁₆ (46)	³ / ₈ (9.5)	5
7210ZP6	Zinc plated	Steel	4 ⁵ / ₈ (117)	1 ⁵ / ₈ (41.3)	1¼ (31.8)	⁷ / ₁₆ (11.1)	1¼ (31.8)	¹ / ₄ (6.4)	10

IN (MM)

PADBOLTS

GENERAL HARDWARE

BRENTON PADBOLT

1006

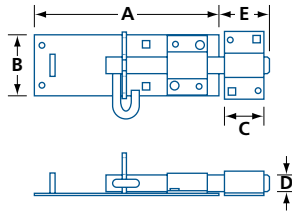

- Durable steel construction
- Accepts shackles up to $\frac{5}{8}$ " (15.9mm)
- 2" (50.8mm) throw
- Heavy duty $\frac{5}{8}$ " (16mm) diameter bolt
- Mounting hardware not included

MODEL	FINISH	MATERIAL	A	B	C	øD	E	MAX PADLOCK SHACKLE DIA
1006	Zinc plated	Steel	6 $\frac{3}{4}$ (171)	2 $\frac{1}{4}$ (57)	1 $\frac{1}{2}$ (38.1)	$\frac{5}{8}$ (15.9)	2 (50.8)	$\frac{5}{8}$ (15.9)

IN (MM)

HEAVY DUTY UTILITY PADBOLT

1419

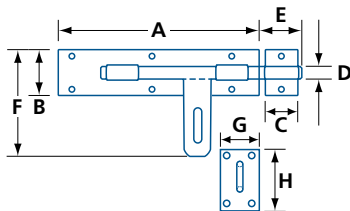

- All new heavy duty design
- Durable steel construction with industrial strength galvanized finish
- Ideal for industrial and agricultural applications
- Accepts shackles up to $\frac{5}{8}$ " (15.9mm) in diameter
- 2 $\frac{3}{4}$ " (70mm) throw for large gaps
- Heavy duty $\frac{5}{8}$ " (15.9mm) diameter bolt
- Mounting hardware not included

MODEL	FINISH	MATERIAL	A	B	C	D	E	F	G	H	MAX PADLOCK SHACKLE DIA
1419	GV	Steel	10 (254)	2 $\frac{1}{2}$ (63.5)	1 $\frac{5}{8}$ (41)	$\frac{5}{8}$ (15.9)	2 $\frac{3}{4}$ (70)	5 $\frac{1}{2}$ (140)	2 (50.8)	3 (76)	$\frac{5}{8}$ (15.9)

IN (MM)



GATE LATCHES

GENERAL HARDWARE

GATE LATCH

278

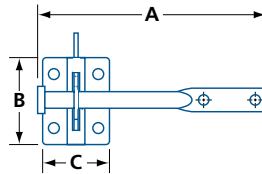
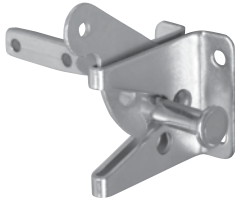

- Mounting hardware included: wood screws

MODEL	FINISH	MATERIAL	A	B	C	MAX PADLOCK SHACKLE DIA	/BOX
278ZP	Zinc plated	Steel	5 (127)	1 ⁷ / ₈ (47.6)	1 ⁷ / ₁₆ (36.5)	1/4 (6.4)	10

IN (MM)

SECRET GATE LATCH

H601

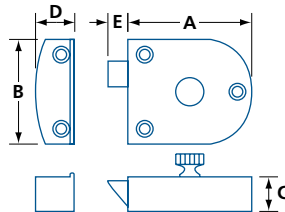
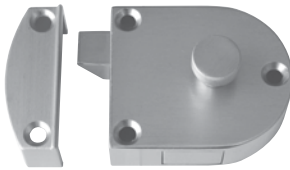

- Mounting hardware included: wood screws

MODEL	FINISH	MATERIAL	A	B	C	D	E	/BOX
H601	C15	Zinc die-cast	2 ¹ / ₄ (57)	1 ¹⁵ / ₁₆ (49.2)	5/8 (15.9)	1 ¹ / ₁₆ (17.5)	3/8 (9.5)	10

IN (MM)

SAFETY HASPS

GENERAL HARDWARE

STANDARD SAFETY HASPS

617

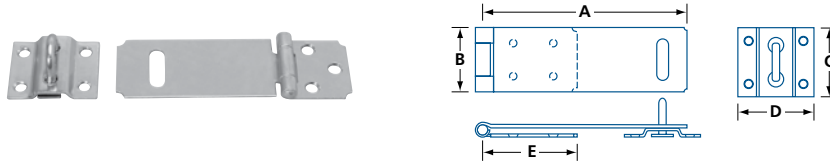

MODEL	FINISH	MATERIAL	A	B	C	D	E	MAX PADLOCK SHACKLE DIA	/BOX
617ZP3	Zinc plated	Steel	3 (76)	1 ¹ / ₈ (28.6)	1 ¹ / ₈ (28.6)	1 ³ / ₈ (35)	1 ⁵ / ₁₆ (23.8)	1/4 (6.3)	12
617ZP35	Zinc plated	Steel	3 ³ / ₈ (85.7)	1 ¹ / ₂ (38.1)	1 ¹ / ₂ (38.1)	1 ¹¹ / ₁₆ (42.9)	1 ¹ / ₄ (31.8)	3/8 (9.5)	12
617ZP45	Zinc plated	Steel	4 ³ / ₈ (111.1)	1 ¹ / ₂ (38.1)	1 ¹ / ₂ (38.1)	1 ³ / ₄ (44.5)	1 ¹ / ₄ (31.8)	3/8 (9.5)	12
617ZP6	Zinc plated	Steel	5 ⁷ / ₈ (149.2)	1 ¹ / ₂ (38.1)	1 ¹ / ₂ (38.1)	1 ³ / ₄ (44.5)	1 ⁵ / ₁₆ (33.3)	3/8 (9.5)	12

IN (MM)

PIVOTING SAFETY HASP

1557

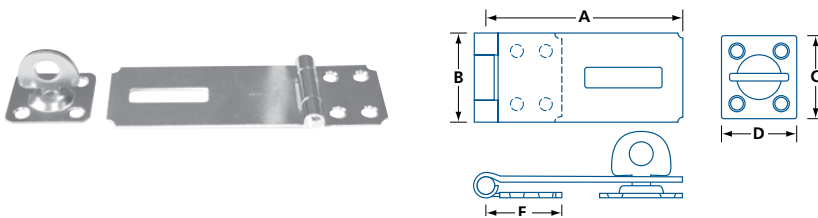

- Staple pivots to vertical or horizontal position
- Mounting hardware included: wood screws

MODEL	FINISH	MATERIAL	A	B	C	D	E	MAX PADLOCK SHACKLE DIA	/BOX
1557ZP35	Zinc plated	Steel	3 ¹ / ₂ (89)	1 ¹ / ₂ (38.1)	1 ¹ / ₄ (31.8)	1 ⁷ / ₁₆ (36.5)	1 ¹ / ₄ (31.8)	3/8 (9.5)	10

IN (MM)

CLOSET HARDWARE

GENERAL HARDWARE

ADJUSTABLE CLOSET ROD

CR

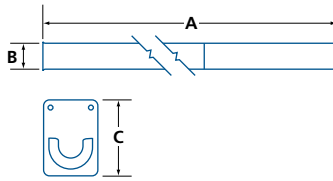

- Adjustable closet rod with wall mounts
- 1" (25.4mm) diameter rod
- Mounting hardware included: wood screws, wall mounts (2) and center support bracket
- Models #CRZP1830 and #CRZP3048 do not include the center support bracket
- Maximum capacity: 40 lbs/12" (18 kg/30 cm)

MODEL	FINISH	MATERIAL	A	B	C	/BOX	/CASE
CRZP1830	Zinc plated	Steel	18 – 30 (460 – 760)				
CRZP3048	Zinc plated	Steel	30 – 48 (760 – 1220)	1 (25.4)	2¾ (70)	5	25
CRZP4872	Zinc plated	Steel	48 – 72 (1220 – 1830)				
CRZP7296	Zinc plated	Steel	72 – 96 (1830 – 2440)	1 (25.4)	2¾ (70)	5	20
CRZP96120	Zinc plated	Steel	96 – 120 (2440 – 3050)				

IN (MM)

ADJUSTABLE CLOSET ROD – FIXED END BRACKETS

CRF

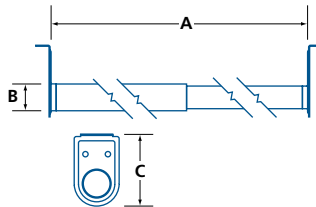

- Adjustable closet rod with fixed end-brackets
- 1" (25.4mm) diameter rod
- Mounting hardware included: wood screws and center support bracket
- Sizes 1830 and 3048 do not include the center support bracket
- Maximum capacity: 40 lbs/12" (18 kg/30 cm)

MODEL	FINISH	SIZE	MATERIAL	A	B	C	/BOX	/CASE
CRF	ZP	1830	Steel	18 – 30 (460 – 760)				
CRF	ZP, W	3048	Steel	30 – 48 (760 – 1220)	1 (25.4)	2⅝ (67)	6	30
CRF	ZP, W	4872	Steel	48 – 72 (1220 – 1830)				
CRF	ZP, W	7296	Steel	72 – 96 (1830 – 2440)				
CRF	ZP, W	96120	Steel	96 – 120 (2440 – 3050)	1 (25.4)	2⅝ (67)	6	18
CRF	ZP, W	96150	Steel	96 – 150 (2440 – 3810)				

IN (MM)

CLOSET HARDWARE

GENERAL HARDWARE

CLOSET SHELF SUPPORTS – WITH CLOSET ROD HOOK

CRSBW-H2



CRSBW-H2

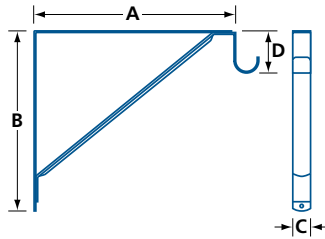

- Can accommodate closet rods up to 1" (25.4 mm) diameter
- Mounting hardware included: wood screws
- Maximum weight capacity : 160 kg (350 lbs)

MODEL	FINISH	MATERIAL	A	B	C	D	/BOX
CRSBW-H2	White	Steel	10½ (267)	10¼ (260)	1 (25.4)	2½ (63.5)	20

IN (MM)

CLOSET SHELF SUPPORTS

CRSBW-2



CRSBW-2

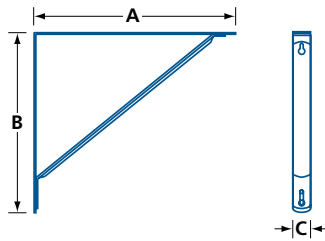

- Mounting hardware included: wood screws
- Maximum weight capacity: 160 kg (350 lbs)

MODEL	FINISH	MATERIAL	A	B	C	D	/BOX
CRSBW-2	White	Steel	10½ (267)	10¼ (260)	1 (25.4)	—	20

IN (MM)



WARDROBE HOOKS

GENERAL HARDWARE

WARDROBE HOOKS – CONTEMPORARY

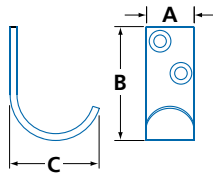

- Stainless steel coat hook
- Mounting hardware included: wood screws, plastic anchors

MODEL	FINISH	MATERIAL	A	B	C
5805	32D	Stainless steel	1 ³ / ₁₆ (20)	2 (51)	1 ⁹ / ₁₆ (40)

IN (MM)

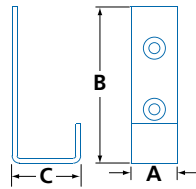

- Stainless steel coat hook
- Mounting hardware included: wood screws, plastic anchors

MODEL	FINISH	MATERIAL	A	B	C
5806	32D	Stainless steel	1 ³ / ₁₆ (20)	2 ⁹ / ₁₆ (65)	1 ¹ / ₄ (31)

IN (MM)

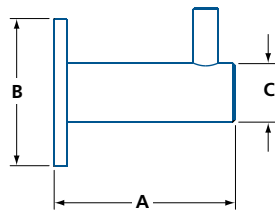

- Stainless steel coat hook
- Concealed mounting
- Mounting hardware included: wood screws, plastic anchors

MODEL	FINISH	MATERIAL	∅ A	B	∅ C
5807	32D	Stainless steel	1 ³ / ₈ (35)	1 ¹¹ / ₁₆ (42)	⁹ / ₁₆ (14)

IN (MM)

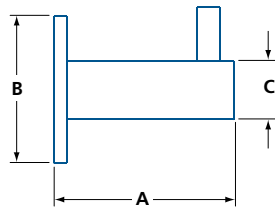
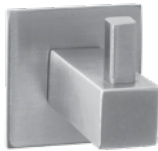

- Stainless steel coat hook
- Concealed mounting
- Mounting hardware included: wood screws, plastic anchors

MODEL	FINISH	MATERIAL	∅ A	B	∅ C
5808	32D	Stainless steel	1 ³ / ₈ (35)	1 ¹¹ / ₁₆ (42)	⁹ / ₁₆ (14)

IN (MM)

WARDROBE HOOKS

GENERAL HARDWARE

WARDROBE HOOKS – TRADITIONAL

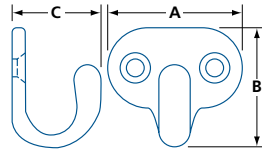

- Solid brass coat hook
- Mounting hardware included: wood screws

MODEL	FINISH	MATERIAL	A	B	C	/BOX
0580	BP	Brass	1 ³ / ₁₆ (30.2)	1 (25.4)	³ / ₄ (19.1)	10

IN (MM)

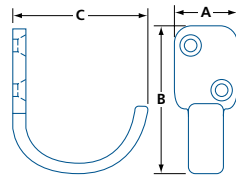

- Solid brass coat hook
- Mounting hardware included: wood screws

MODEL	FINISH	MATERIAL	A	B	C	/BOX
0595	BP	Brass	1 ¹ / ₁₆ (17.5)	1 ¹ / ₁₆ (42.8)	1 ⁹ / ₁₆ (39.7)	50

IN (MM)

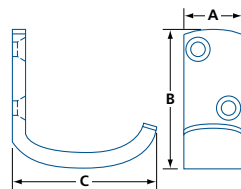

- Solid brass coat hook
- Mounting hardware included: wood screws

MODEL	FINISH	MATERIAL	A	B	C	/BOX
5803	BP	Brass	1 ¹ / ₁₆ (17.5)	1 ¹ / ₄ (31.8)	1 ⁵ / ₈ (42)	25

IN (MM)

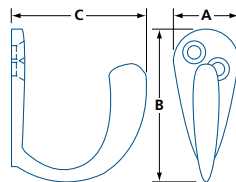

- Zinc die-cast coat hook
- Mounting hardware included: wood screws

MODEL	FINISH	MATERIAL	A	B	C	/BOX
3542	BP, CHR	Zinc die-cast	1 ¹ / ₁₆ (17.5)	1 ¹ / ₂ (38.1)	1 ¹ / ₂ (38.1)	100

IN (MM)

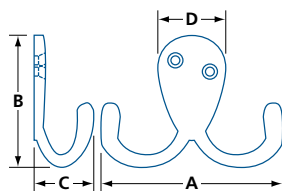

- Zinc die-cast double coat hook
- Mounting hardware included: wood screws

MODEL	FINISH	MATERIAL	A	B	C	D	/BOX
3541	BP, CHR	Zinc die-cast	2 ¹³ / ₁₆ (71.4)	1 ⁷ / ₈ (47.6)	1 ¹ / ₁₆ (27)	1 ⁵ / ₁₆ (23.8)	50

IN (MM)



WARDROBE HOOKS

GENERAL HARDWARE

WARDROBE HOOKS – HAT & COAT

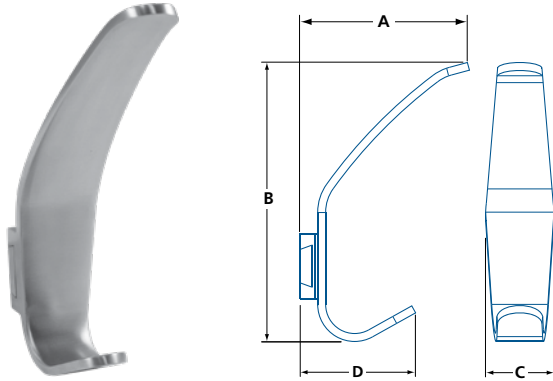

- Contemporary stainless steel hook
- Concealed mounting
- Mounting hardware included: wood screws, plastic anchors and hex key

MODEL	FINISH	MATERIAL	A	B	C	D	/BOX
5804	32D	Stainless steel	17/16 (37)	515/16 (151)	39/16 (90)	21/2 (64)	4

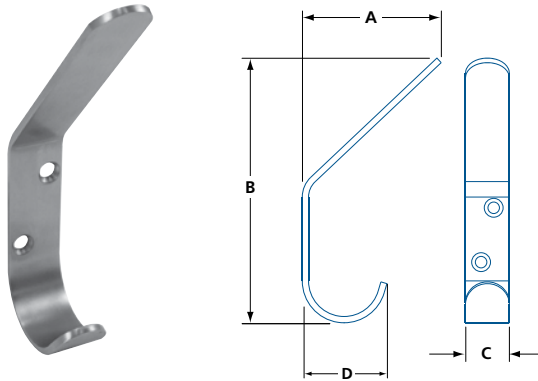

- Contemporary stainless steel hook
- Mounting hardware included: wood screws, plastic anchors

MODEL	FINISH	MATERIAL	A	B	C	D	/BOX
5802	32D	Stainless steel	3/4 (19)	51/2 (140)	25/16 (58)	13/4 (44)	10

IN (MM)

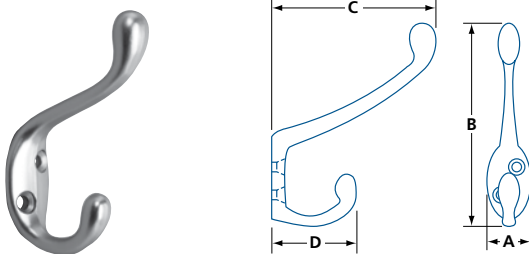

- Traditional coat & hat hook
- Mounting hardware included: wood screws

MODEL	FINISH	MATERIAL	A	B	C	D	/BOX
3543	BP, CHR, C26D	Zinc Diecast	13/16 (20.6)	31/2 (89)	2 (50.8)	49/16 (40)	10
3545	BP, CHR	Zinc Diecast	1 (25.4)	47/8 (118)	31/2 (89)	2 (50.8)	10

IN (MM)

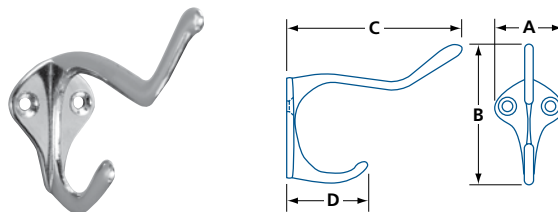

- Traditional coat & hat hook
- Mounting hardware included: wood screws

MODEL	FINISH	MATERIAL	A	B	C	D	/BOX
6206	BP, CHR	Zinc Diecast	11/8 (28.6)	21/4 (57)	23/4 (70)	13/8 (34)	10

IN (MM)

HANDRAIL BRACKETS

GENERAL HARDWARE

HANDRAIL BRACKETS

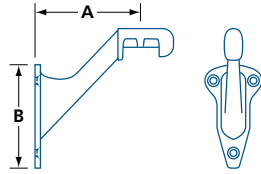

- **#3590L** Backset with large projection is the best choice for new building code compliance
- Mounting hardware included: wood screws, mounting bracket



MODEL	FINISH	MATERIAL	A	B	/BOX
3590L	C3, C11P, C15, C15A, C19	Zinc die-cast	3¼ (83)	2¼ (57)	50
3590	C15	Zinc die-cast	2¾ (59)	2¼ (57)	25

IN (MM)

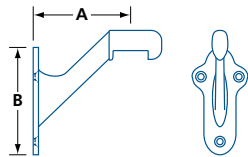

- Heavy-duty
- Mounting hardware included: wood screws, mounting bracket



MODEL	FINISH	MATERIAL	A	B	/BOX
695	C3, C15, NP	Zinc die-cast	2⅞ (67)	2⅛ (75)	50

IN (MM)

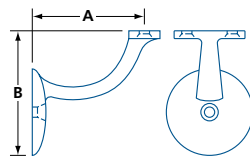

- Mounting hardware included: wood screws

MODE	FINISH	MATERIAL	A	B	/BOX
8424	C3, C5, C11P, C15A, C26D	Zinc die-cast	2¾ (70)	3⅞ (79)	10

IN (MM)



DOOR CATCHES & LATCHES

GENERAL HARDWARE

ROLLER CATCH

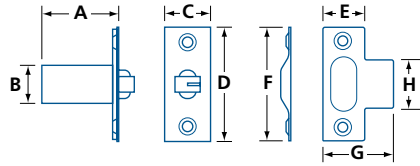

- For wood door and frame
- Nylon roller
- Adjustable for door gap
- Mounting hardware included: wood screws
- Includes T-Strike

MODEL	FINISH	MATERIAL	A	∅B	C	D	E	F	G	H	/BOX
01012	C26D	Zinc die-cast	1½ (38.8)	¾ (19.1)	29/32 (23)	2¼ (58)	13/16 (21)	2¼ (58)	19/16 (36)	11/16 (27.3)	25

IN (MM)

HEAVY DUTY ROLLER CATCH

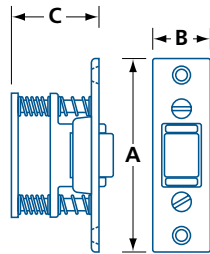

- Adjustment for door gap
- Adjustable spring tension on roller
- Mounting hardware included: wood screws

- #01015 No strike included
- #01015D Includes full lip D-strike
- #01015T Includes T-strike
- #01015ASA Includes ASA-strike

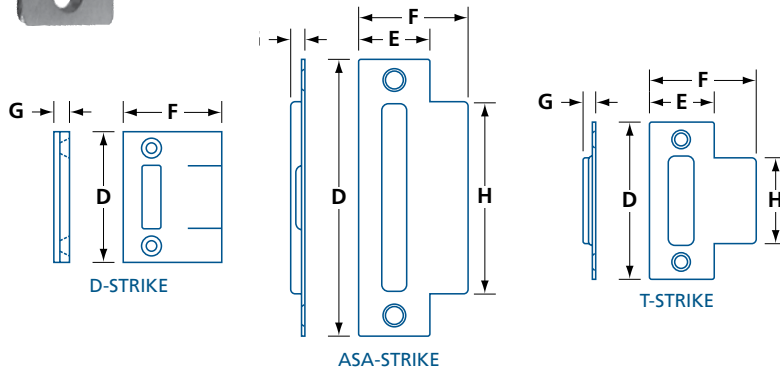

MODEL	FINISH	MATERIAL	A	B	C	D	E	F	G	H	/BOX
01015	C26D	Zinc die-cast	39/16 (86)	1 (25.4)	19/16 (39.6)	—	—	—	—	—	10
01015D	C3, C26D	Zinc die-cast	39/16 (86)	1 (25.4)	19/16 (39.6)	29/32 (58)	—	1¾ (44.5)	3/16 (4.8)	—	10
01015T	C26D	Zinc die-cast	39/16 (86)	1 (25.4)	19/16 (39.6)	2¾ (70)	15/32 (29.4)	17/8 (47.6)	1/16 (1.5)	1½ (38.8)	10
01015ASA	C26D	Zinc die-cast	39/16 (86)	1 (25.4)	19/16 (39.6)	47/8 (124)	1¼ (38.1)	115/16 (49.2)	3/32 (2.4)	39/16 (86)	—

IN (MM)

DOOR CATCHES & LATCHES

GENERAL HARDWARE

BALL CATCH

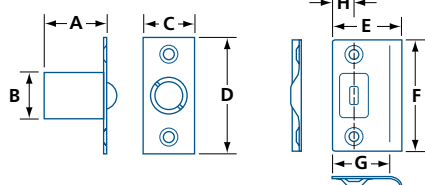

- For wood door and frame
- Strike included for 1 3/8" (35 mm) thick door
- Mounting hardware included: wood screws

MODEL	FINISH	MATERIAL	A	ø B	C	D	E	F	G	H	/BOX
01013	C3, C5, C15A, C26, C26D	Steel	1 3/16 (30.1)	27/32 (21.5)	1 (25.4)	2 1/4 (57)	1 7/16 (36.5)	2 1/8 (54)	1 3/16 (30)	1/2 (12.7)	50

IN (MM)

BALL CATCH – ADJUSTABLE

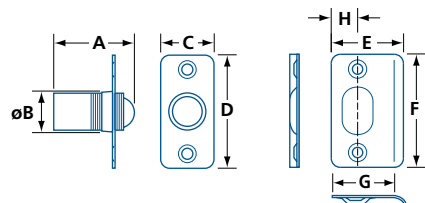
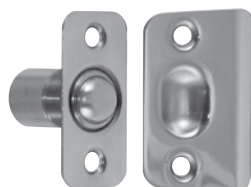

- For wood door and frame
- Adjustable spring tension
- Adjustable for frame gap to 3/16" (5 mm)
- Strike for 1 3/8" (35 mm) doors; 3/16" (5 mm) rounded corners
- Mounting hardware included: wood screws
- Brass body and faceplate
- Steel ball and strike

MODEL	FINISH	MATERIAL	A	ø B	C	D	E	F	G	H	/BOX
01014	C3, C10B, C15, C15A, C19, C26D	Brass	1 1/16 to 1 1/4 (27 to 31.8)	25/32 (19,8)	1 (25.4)	2 1/8 (54)	1 3/8 (35,4)	2 1/8 (54)	1 3/16 (30)	1/2 (12.7)	20

IN (MM)

BALL CATCH – DRIVE IN

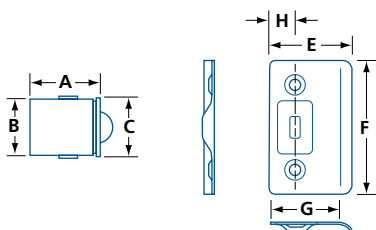
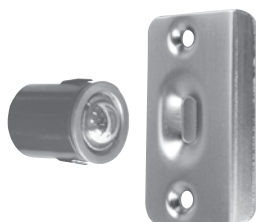

- For wood door and frame
- Zinc die-cast body, with steel ball and strike
- Fits into 1" (25.4 mm) bore
- Strike for 1 3/8" (35 mm) doors; 7/32" (5 mm) rounded corners
- Mounting hardware included: wood screws

MODEL	FINISH	MATERIAL	A	ø B	ø C	E	F	G	H	/BOX
01003	C10B, C11P, C15, C19, C26, C26D	Zinc die-cast	1 3/16 (30.1)	15/16 (23.8)	1 (25.4)	1 3/8 (34.9)	2 1/4 (57)	1 3/16 (30)	1/2 (12.7)	50

IN (MM)



LAVATORY PARTITION

GENERAL HARDWARE



LAVATORY HARDWARE



Lavatory Clamp Flange Spring Hinge.

Single action with adjustable spring tension. For doors and jambs $\frac{7}{8}$ - $1\frac{1}{4}$ " (22-32 mm) thick.

1001

3½x4" (89x102 mm)

01001

3½x2" (89x51 mm)

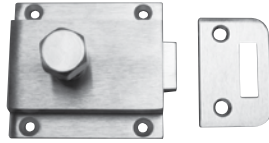

5019

Rim bolt & keeper.

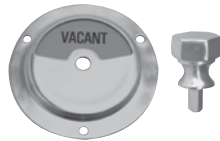

5017

Occupancy indicator & emergency key. Pairs with #5019 rim bolt.

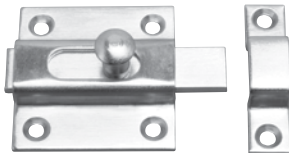

5004

Rim Bolt & Keeper.

- BOMMER offers a wide variety of lavatory hardware items including partition supports, door hinges, spring hinges, door stops and locks
- All made in solid brass and available in a variety of finishes

Please contact to order or visit www.bommer.com for details.

BATH HARDWARE

GENERAL HARDWARE

DOREX BATH HARDWARE – RIDGE

BH-RG



BH-RG18-26 / BH-RG24-26

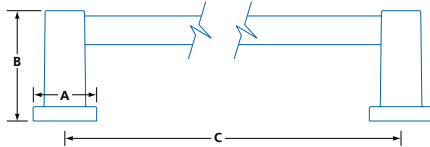

TOWEL BAR

- Zinc posts with stainless steel bar
- Includes mounting hardware

MODEL	LENGTH	FINISH	A	B	C*
BH-RG	18	26, 19	1 $\frac{5}{8}$ (42)	2 $\frac{7}{8}$ (73)	18 (457.2)
	24				24 (609.6)

IN (MM) (*) CENTER TO CENTER LENGTH



BH-RG53-26

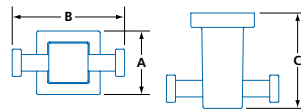

DOUBLE ROBE HOOK

- Zinc posts with brass robe hooks
- Includes mounting hardware

MODEL	FINISH	A	B	C
BH-RG53	26, 19	1 $\frac{5}{8}$ (42)	2 $\frac{15}{16}$ (74.3)	2 $\frac{1}{2}$ (63)

IN (MM)



BH-RG55-26

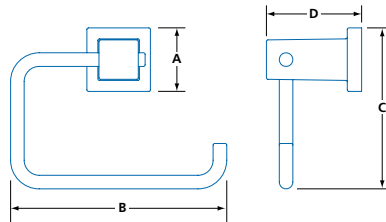

PAPER HOLDER

- Zinc post with steel paper holder
- Includes mounting hardware

MODEL	FINISH	A	B	C	D
BH-RG55	26, 19	1 $\frac{5}{8}$ (42)	5 $\frac{5}{8}$ (143)	4 $\frac{3}{16}$ (106.5)	2 $\frac{1}{2}$ (63)

IN (MM)



BH-RG60-26

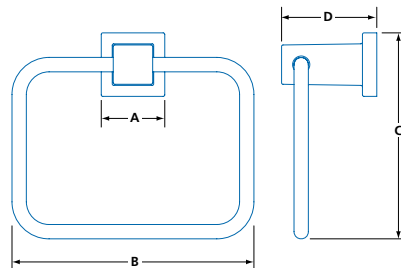

TOWEL RING

- Zinc post with stainless steel ring
- Includes mounting hardware

MODEL	FINISH	A	B	C	D
BH-RG60	26, 19	1 $\frac{5}{8}$ (42)	6 $\frac{5}{16}$ (160)	5 $\frac{3}{8}$ (136.3)	2 $\frac{1}{2}$ (63)

IN (MM)

BATH HARDWARE

GENERAL HARDWARE

DOREX BATH HARDWARE – CONTOUR

BH-CN

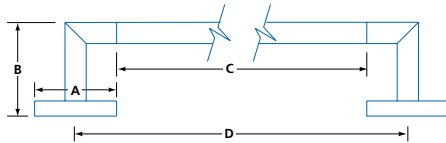

TOWEL BAR

- Zinc post with stainless steel bar
- Includes mounting hardware

MODEL	LENGTH	FINISH	A	B	C	D*
BH-CN	18	26, 19	2 ³ / ₈ (60.0)	2 ³ / ₄ (70.8)	18 (457.2)	20 ³ / ₁₆ (513.2)
	24				24 (609.6)	26 ³ / ₁₆ (665.6)

IN (MM) (*) CENTER TO CENTER LENGTH



BH-CN53-26

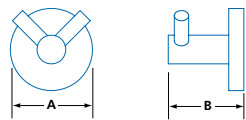

BH-CN54-26

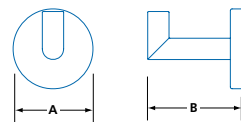

ROBE HOOKS

- #BH-CN53 (Double Hook): Zinc post with steel robe hooks
- #BH-CN54 (Single Hook): Zinc post and robe hooks
- Includes mounting hardware

MODEL	FINISH	A	B
BH-CN53	26, 19	2 ³ / ₈ (60.0)	2 ¹ / ₈ (53.7)
BH-CN54			2 ³ / ₄ (70.8)

IN (MM)



BH-CN55-26

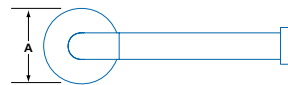
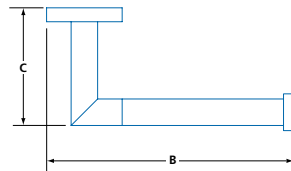

PAPER HOLDER

- Zinc post with stainless steel tube
- Includes mounting hardware

MODEL	FINISH	A	B	C
BH-CN55	26, 19	2 ³ / ₈ (60.0)	6 ⁷ / ₈ (175.0)	2 ¹⁵ / ₁₆ (74.8)

IN (MM)



BH-CN60-26

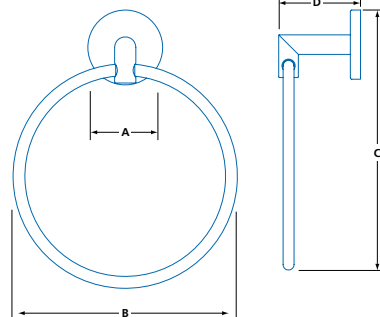

TOWEL RING

- Zinc post with stainless steel ring
- Includes mounting hardware

MODEL	FINISH	A	B	C	D
BH-CN60	26, 19	2 ³ / ₈ (60.0)	7 ³ / ₃₂ (180.0)	8 ⁷ / ₈ (225.3)	2 ³ / ₄ (70.8)

IN (MM)



BATH HARDWARE

GENERAL HARDWARE

DOREX BATH HARDWARE – VECTOR

BH-VC



BH-VC18-26 / BBH-VC24-26

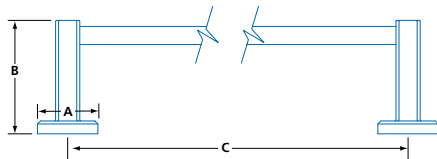

TOWEL BAR

- Zinc posts with stainless steel bar
- Includes mounting hardware

MODEL	LENGTH	FINISH	A	B	C*
BH-VC	18	15, 19, 26	1 $\frac{9}{16}$ (40)	3 (75)	17 $\frac{3}{4}$ (451.2)
	24				23 $\frac{3}{4}$ (603.6)

IN (MM) (*) CENTER TO CENTER LENGTH



BH-VC54-26

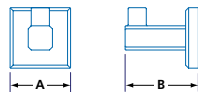

SINGLE ROBE HOOK

- Zinc post and robe hook
- Includes mounting hardware

MODEL	FINISH	A	B
BH-VC54	15, 19, 26	1 $\frac{9}{16}$ (40)	1 $\frac{7}{8}$ (48.5)

IN (MM)



BH-VC55-26

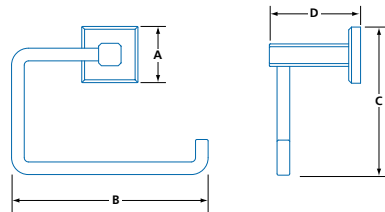

PAPER HOLDER

- Zinc post and paper holder
- Includes mounting hardware

MODEL	FINISH	A	B	C	D
BH-VC55	15, 19, 26	1 $\frac{9}{16}$ (40)	5 $\frac{1}{2}$ (140)	4 $\frac{7}{32}$ (105.5)	2 $\frac{9}{16}$ (65)

IN (MM)



BH-VC60-26

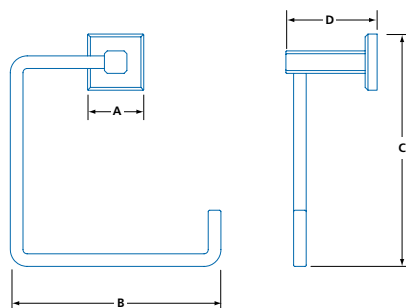

TOWEL RING

- Zinc post and ring
- Includes mounting hardware

MODEL	FINISH	A	B	C	D
BH-VC60	15, 19, 26	1 $\frac{9}{16}$ (40)	5 $\frac{15}{16}$ (150)	6 $\frac{1}{2}$ (165.5)	2 $\frac{9}{16}$ (65)

IN (MM)

BATH HARDWARE

GENERAL HARDWARE

DOREX BATH HARDWARE KIT – VECTOR

BH-VCK



4 PIECE BATH SET

- Complete bath set for any bathroom
- Includes mounting hardware

BH-VCK24 - 26

MODEL FINISH

15

SATIN NICKEL

19

MATTE BLACK

26

POLISHED
CHROME

INCLUDES

- » 24in Towel Bar (#BH-VC24)
- » Single Robe Hook (#BH-VC54)
- » Paper Holder (#BH-VC55)
- » Towel Ring (#BH-VC60)

See page 06.612 for details



BATH HARDWARE

GENERAL HARDWARE

DOREX BATH HARDWARE – HORIZON

BH-HR



BH-HR18-26 / BH-HR24-26

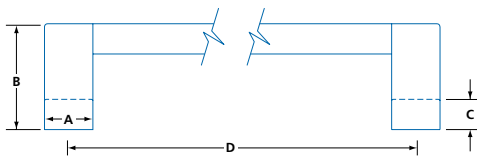

TOWEL BAR

- Zinc posts with stainless steel bar
- Includes mounting hardware

MODEL	LENGTH	FINISH	A	B	C	D*
BH-HR	18	26, 19	1 ⁹ / ₁₆ (40)	2 ³ / ₄ (70)	5/ ₈ (16)	18 (489.2)
	24					24 (641.6)

IN (MM) (*) CENTER TO CENTER LENGTH



BH-HR53-26

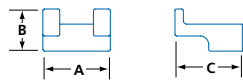

BH-HR54-26

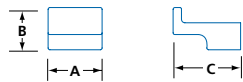

ROBE HOOKS

- Solid zinc robe hooks
- Double hook (#BH-HR53) and single hook (#BH-HR54) models
- Includes mounting hardware

MODEL	FINISH	A	B	C
BH-HR53	26, 19	1 ⁹ / ₁₆ (40)	1 (25)	1 ⁹ / ₁₆ (40)
BH-HR54		1 ⁵ / ₈ (32)		

IN (MM)



BH-HR55-26

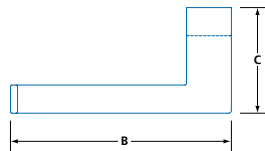

PAPER HOLDER

- Solid zinc paper holder
- Includes mounting hardware

MODEL	FINISH	A	B	C
BH-HR55	26, 19	7/ ₈ (22)	6 ³ / ₁₆ (157)	3 (75)

IN (MM)



BH-HR60-26

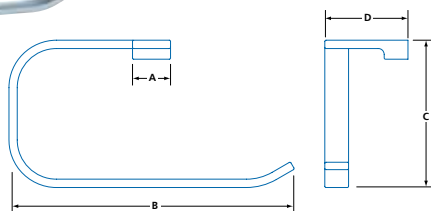

TOWEL RING

- Solid zinc ring
- Includes mounting hardware

MODEL	FINISH	A	B	C	D
BH-HR60	26, 19	1 ⁹ / ₁₆ (40)	6 ⁵ / ₁₆ (240)	5 ³ / ₈ (124)	2 ³ / ₄ (70)

IN (MM)

BATH HARDWARE

GENERAL HARDWARE

DOREX BATH HARDWARE – ELEMENT

BH-ET



BH-ET18-26 / BH-ET24-26

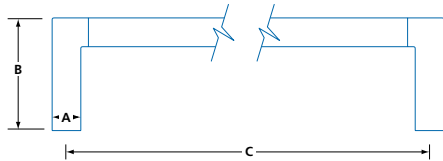

TOWEL BAR

- Zinc posts with stainless steel bar
- Includes mounting hardware

MODEL	LENGTH	FINISH	A	B	C*
BH-ET	18	26, 19	$\frac{3}{4}$ (19)	3 (74.5)	$19\frac{1}{8}$ (486.2)
	24				$25\frac{1}{8}$ (638.6)

IN (MM) (*) CENTER TO CENTER LENGTH



BH-ET54-26

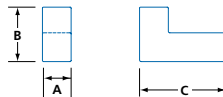

ROBE HOOK

- Zinc robe hooks
- Includes mounting hardware

MODEL	FINISH	A	B	C
BH-ET54	26, 19	$\frac{3}{4}$ (19)	$1\frac{1}{16}$ (36)	$2\frac{1}{4}$ (57)

IN (MM)



BH-ET55A-26



BH-ET97-26

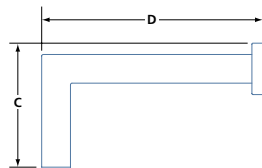

PAPER HOLDERS

- Zinc paper holders
- Horizontal mounted (#BH-E55A)
- Vertical mounted (#BH-E97) for spare paper roll
- Includes mounting hardware

MODEL	FINISH	TYPE	A	B	C	D
BH-ET55A	26, 19	Horizontal	$\frac{3}{4}$ (19)	$1\frac{3}{8}$ (34)	$4\frac{3}{16}$ (106.5)	$5\frac{5}{8}$ (143)
BH-ET97		Vertical				

IN (MM)



BH-ET60-26

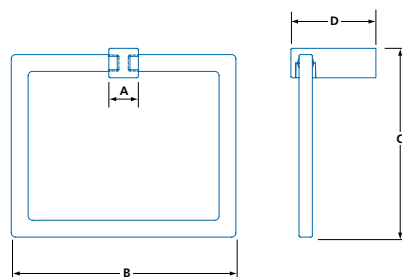

TOWEL RING

- Zinc post with zinc ring
- Includes mounting hardware

MODEL	FINISH	A	B	C	D
BH-ET60	26, 19	$\frac{3}{4}$ (19)	$6\frac{5}{16}$ (160)	$5\frac{1}{4}$ (134.5)	$2\frac{3}{8}$ (60.5)

IN (MM)

MAGNETIC CATCHES

GENERAL HARDWARE

MAGNETIC CATCH

M700

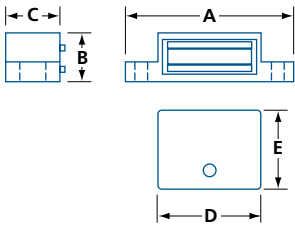
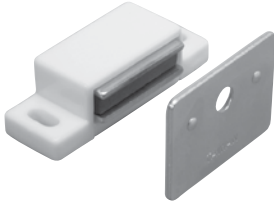

- Zinc plated steel strike
- Plastic housing with magnet
- Magnet holding capacity is 2 lbs (0.9 kg)

MODEL	FINISH	A	B	C	D	E	/BOX
M700	B, W, WA	1 ³ / ₄ (44.5)	1/2 (12.7)	9/16 (14.3)	1 ³ / ₁₆ (30.5)	29/32 (23)	100

IN (MM)

MAGNETIC CATCH – HIGH STRENGTH

M1800-1

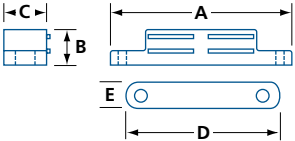

- Zinc plated steel strike
- Plastic housing with magnet
- Magnet holding capacity is 18 lbs (8 kg)

MODEL	FINISH	A	B	C	D	E	/BOX
M1800-1	White	27/8 (73)	9/16 (14.3)	11/16 (17.5)	23/8 (60)	1/2 (12.7)	20

IN (MM)

MAGNETIC CATCH – TALL

M2800

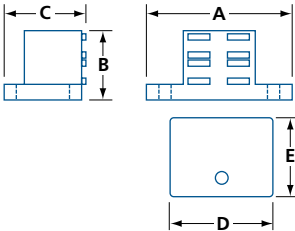

- Zinc plated steel strike
- Plastic housing with magnet
- Magnet holding capacity is 6 lbs (2.7 kg)
- Includes mounting screws

MODEL	FINISH	A	B	C	D	E	/BOX
M2800W	White	1 ²⁵ / ₃₂ (45)	7/8 (22.2)	15/16 (24)	17/32 (31)	29/32 (23)	50

IN (MM)

BALL & ROLLER CATCHES

GENERAL HARDWARE

BALL & ROLLER CATCHES

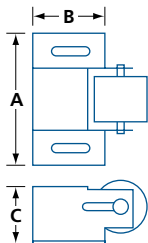
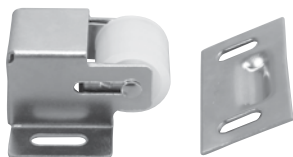

JUMBO ROLLER CATCH

- Spring loaded plastic roller
- Mounting hardware included: wood screws

MODEL	FINISH	MATERIAL	A	B	C	/BOX
2804	Zinc plated	Steel	1 ¹⁵ / ₁₆ (49.4)	1 (25.4)	1 ⁵ / ₁₆ (23.8)	50

IN (MM)

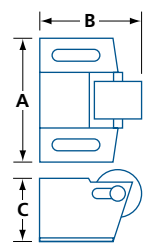

SINGLE ROLLER CATCH

- Spring loaded plastic roller
- Mounting hardware included: wood screws

MODEL	FINISH	MATERIAL	A	B	C	/BOX
950	Zinc plated	Steel	1 ³ / ₈ (34.9)	3/4 (19.1)	1 ¹ / ₁₆ (17.5)	100

IN (MM)

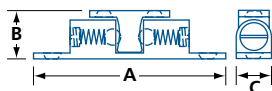
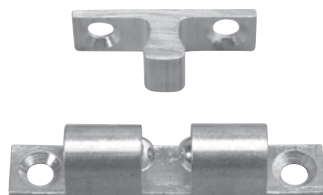

BRASS BALL CATCH

- Spring loaded steel balls
- Adjustable spring tension

MODEL	FINISH	MATERIAL	A	B	C	/BOX
112	Polished brass	Brass	1 ¹⁵ / ₁₆ (49.4)	1/2 (12.7)	3/8 (9.5)	40

IN (MM)

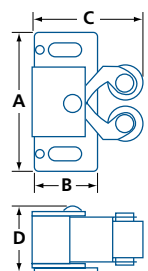
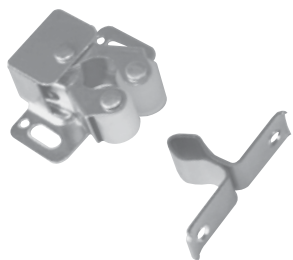

DOUBLE ROLLER CATCH

- Spring loaded plastic rollers
- Mounting hardware included: wood screws

MODEL	FINISH	MATERIAL	A	B	C	D	/BOX
3631ZP	Zinc plated	Steel	1 ¹ / ₄ (31.8)	9/16 (14.3)	1 ¹ / ₈ (28.6)	5/8 (15.9)	100

IN (MM)

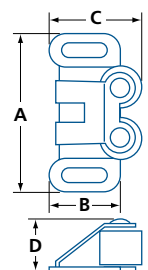

DOUBLE ROLLER CATCH WITH CLIP

- Plastic rollers
- Spring c-clip
- Mounting hardware included: wood screws

MODEL	FINISH	MATERIAL	A	B	C	D	/BOX
3632ZP	Zinc plated	Steel	1 ¹¹ / ₁₆ (42.9)	3/4 (19.1)	1 ⁵ / ₁₆ (23.8)	1/2 (12.7)	100

IN (MM)



REINFORCEMENT HARDWARE

GENERAL HARDWARE

REINFORCEMENT BRACES

366 SERIES

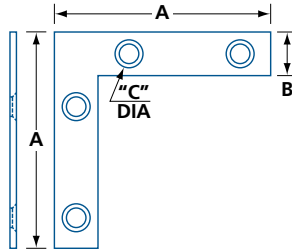

MODEL	FINISH	MATERIAL	A	B	ϕC	/BOX
36611-15	Zinc Plated	Steel	1½ (38.1)	¾ (9.5)	⅜ (4.8)	20
36611-2	Zinc Plated	Steel	2 (50.8)	¾ (9.5)	⅜ (4.8)	20

IN (MM)

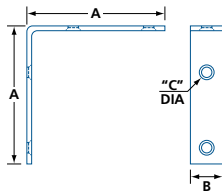

MODEL	FINISH	MATERIAL	A	B	ϕC	/BOX
36615-1	Zinc Plated	Steel	1 (25.4)	½ (12.7)	⅞ (5.6)	20
36615-15	Zinc Plated	Steel	1½ (38.1)	½ (12.7)	⅞ (5.6)	20
36615-2	Zinc Plated	Steel	2 (50.8)	⅝ (15.9)	⅞ (5.6)	20
36615-25	Zinc Plated	Steel	2½ (64)	⅝ (15.9)	⅞ (5.6)	20
36615-3	Zinc Plated	Steel	3 (76)	¾ (19.1)	¼ (6.4)	20
36615-4	Zinc Plated	Steel	4 (102)	⅞ (22.2)	¼ (6.4)	10

IN (MM)

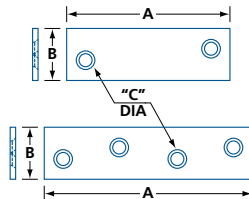
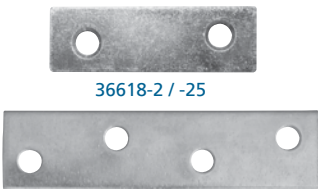

MODEL	FINISH	MATERIAL	A	B	ϕC	/BOX
36618-2	Zinc Plated	Steel	2 (50.8)	⅝ (15.9)	⅞ (5.6)	20
36618-25	Zinc Plated	Steel	2½ (38.1)	⅝ (15.9)	⅞ (5.6)	20
36618-3	Zinc Plated	Steel	3 (76)	¾ (19.1)	⅞ (5.6)	20
36618-4	Zinc Plated	Steel	4 (102)	⅞ (22.2)	⅞ (5.6)	20

IN (MM)

SLIDING HARDWARE

GENERAL HARDWARE

SLIDING DOOR HARDWARE

10-4060



- For pocket-door, wall-mounted, by-pass or multi-track applications
- For door panel 1 – 1 $\frac{3}{4}$ " (25.4 – 44.5 mm) thick when using fascia*
- Load capacity: 132 lbs (60 kg) per door panel
- Zinc die-cast hangers with ball bearing nylon wheels
- 2 hangers per door panel (one kit per door panel)
- Optional floor guides available, see 06.850

(*) Without fascia, maximum thickness is limited by installation and door weight.

For application options, please request an Application Guide.

MODEL	CAPACITY	TRACK*	FASCIA*
10-4060	(2) Ball bearing hangers (2) In-track stop/holders (1) Floor guide (1) Adjustment tool (10) Mounting screws (2) Plastic floor anchors	132 lbs (60 kg)	TR01, TR02B TRF01B**

(*) ALUMINUM TRACKS AND FASCIA SOLD SEPARATELY, VARIOUS LENGTHS AVAILABLE
(**) MAX. DOOR THICKNESS: 1 $\frac{3}{4}$ " (44.5MM)

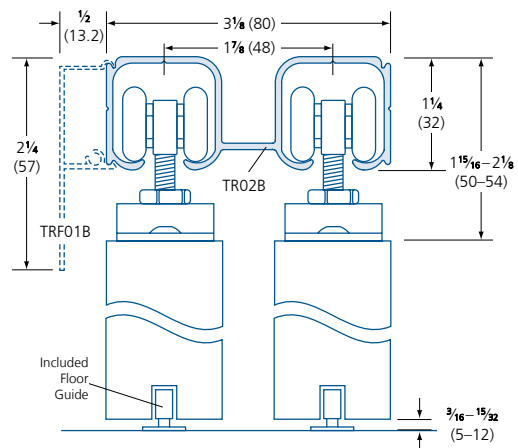
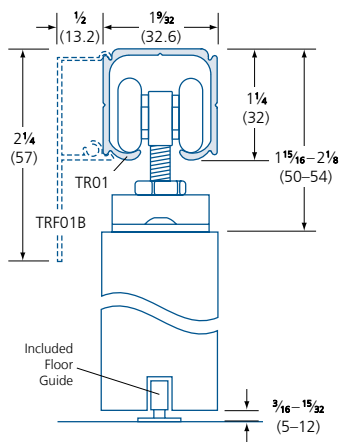

SLIDING HARDWARE

GENERAL HARDWARE

BY-PASS DOOR HARDWARE

20-4030-REV1



• **Updated model**

- For by-pass or multi-track applications including wardrobes, closets, room dividers and office partitions
- Maximum panel width: 1 3/4" (44.5 mm) using included floor guide, 1 3/8" (35 mm) thick using floor guide 21-1025-FG (not included)
- Load capacity: 66 lbs (30 kg) per door panel
- Aluminum side-mount hangers with ball bearing nylon wheels
- 2 hangers per door panel (one kit per pair of door panels)
- **NEW:** Vertical adjustment slot for ease of installation (up to 3/16")
- Alternative floor guides available as option, see 06.850

For application options, please request an Application Guide.

MODEL	CAPACITY	TRACK*	FASCIA*
20-4030-REV1	66 lbs (30 kg)	TR02B	TRF01B

(4) Ball bearing hangers
(4) In-track stoppers
(2) Floor guides
(20) Mounting screws
(4) Plastic anchors

(*) ALUMINUM TRACKS AND FASCIA SOLD SEPARATELY, VARIOUS LENGTHS AVAILABLE

Option with Floor Guide included in kit 20-4030-REV1

Requires Door Preparation

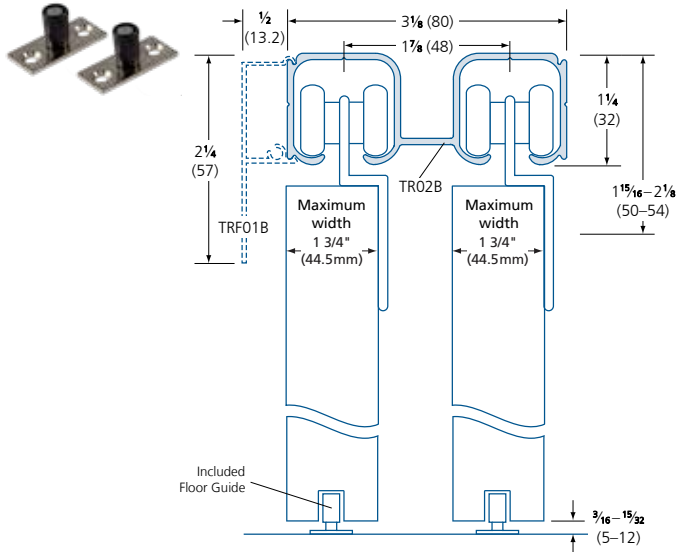

Option with Floor Guide 21-1025-FG not included with kit 20-4030-REV1. See page 06.850

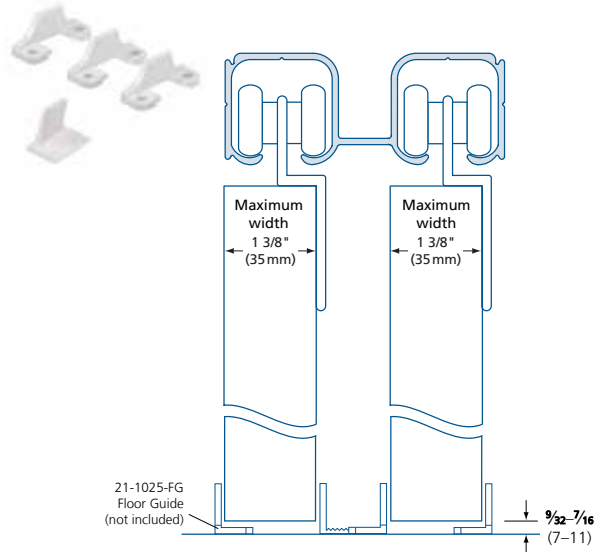

SLIDING HARDWARE

GENERAL HARDWARE

BY-PASS DOOR HARDWARE

21-1025

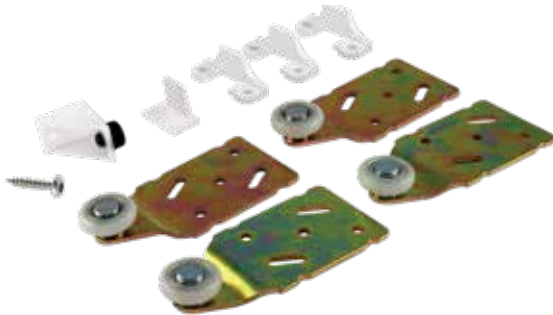

- For by-pass applications including wardrobes and closets
- For door panels up to 1 3/4" (44.5 mm) thick
- Load capacity: 55 lbs (25 kg) per door panel
- Steel side-mount hangers with ball bearing nylon wheels
- 2 hangers per door panel (one kit per two door panels)
- Optional floor guides available, see 06.850

For application options, please request an Application Guide.

MODEL		CAPACITY	TRACK*	FASCIA
21-1025	(4) Ball bearing hangers (1) Stop (1) 3-piece floor guide (24) Mounting screws	162 lbs (60 kg)	TR11	—

(*) ALUMINUM TRACK SOLD SEPARATELY, VARIOUS LENGTHS AVAILABLE

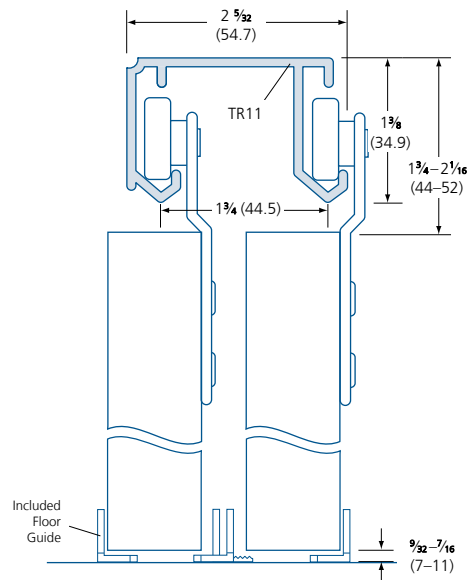

SLIDING HARDWARE

GENERAL HARDWARE

BI-FOLD DOOR HARDWARE

31-1015

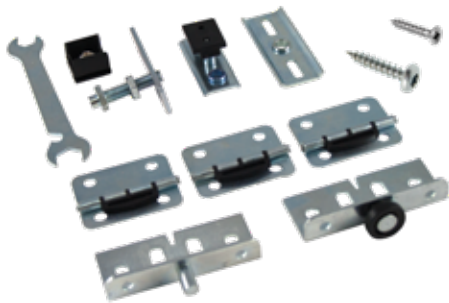

- Bi-fold door hardware for light-duty applications including closets, pantries and concealing utility and storage areas
- For door panels up to 1 $\frac{3}{8}$ " (35 mm)
- Load capacity: 33 lbs (15 kg) per bi-folding door
- Steel pivot assembly with ball bearing nylon wheel guide
- Steel panel hinges
- One kit per bi-folding door

For application options, please request an Application Guide.

MODEL	CAPACITY	TRACK*	FASCIA*
31-1015	(1) Top pivot assembly (1) Floor pivot (1) In-track stop/holder (1) Ball bearing guide (3) Panel hinges (1) Adjustment tool (20) Panel screws (5) Pivot screws	33 lbs (15 kg)	TR21 —

(*) ALUMINUM TRACK SOLD SEPARATELY, VARIOUS LENGTHS AVAILABLE

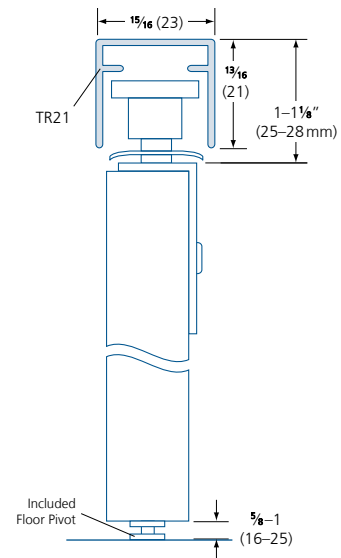

SLIDING HARDWARE

GENERAL HARDWARE

BI-FOLD DOOR HARDWARE

31-4060

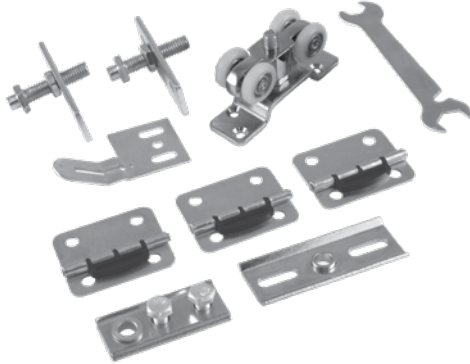

- For bi-fold door applications including wardrobes and closets
- For door panels $1\frac{3}{8}$ - $1\frac{3}{4}$ " (35 - 44.5 mm) thick
- Load capacity: 132 lbs (60 kg) per bi-fold door assembly
- Zinc die cast hangers with ball bearing nylon wheels
- 1 hanger per bi-fold door assembly

For application options, please request an Application Guide.

MODEL	CAPACITY	TRACK*	FASCIA
31-4060	132 lbs (60 kg)	TR01	—

(1) Ball bearing hanger
 (1) Top pivot assembly
 (1) Floor pivot assembly
 (1) Ball bearing guide
 (3) Panel hinges
 (1) Adjustment tool
 (20) Panel screws
 (5) Pivot screws

(*) ALUMINUM TRACK SOLD SEPARATELY, VARIOUS LENGTHS AVAILABLE

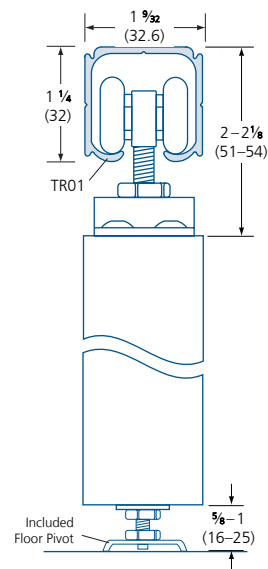

SLIDING HARDWARE

GENERAL HARDWARE

SLIDING TRACKS

TR01, TR02B, TR11, TR21

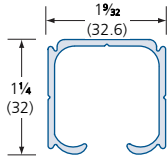

TR01 SINGLE TRACK

- Extruded aluminum track, mill finish
- Pre-drilled top mounting holes every 16" (406mm) to match wall mount (#WM01)
- Snap-on fascia (#TRF01B) available for one or both sides with matching end-caps (#TRFC01/TRFC01D) also available
- Wall mount bracket (#WM01) available
- Custom lengths available by special order
- Mounting hardware and screws are NOT included

STANDARD LENGTHS*

TR01-36	36" (914mm)
TR01-48	48" (1219mm)
TR01-60	60" (1524mm)
TR01-72	72" (1828mm)
TR01-84	84" (2133mm)
TR01-96	96" (2438mm)
TR01-108	108" (2743mm)
TR01-120	120" (3048mm)

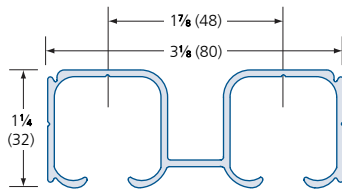

TR02B DOUBLE TRACK

- Extruded aluminum track, mill finish
- Pre-drilled top mounting holes every 12" (305mm)
- Snap-on fascia (#TRF01B) available for one or both sides
- Custom lengths available by special order
- Mounting hardware and screws are NOT included

STANDARD LENGTHS*

TR02B-48	48" (1219mm)
TR02B-60	60" (1524mm)
TR02B-72	72" (1828mm)
TR02B-84	84" (2133mm)
TR02B-96	96" (2438mm)
TR02B-108	108" (2743mm)
TR02B-120	120" (3048mm)

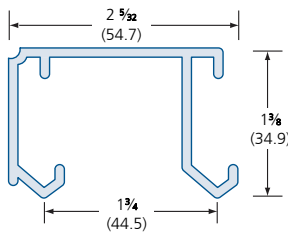

TR11 J-TRACK

- Extruded aluminum track, mill finish
- Pre-drilled top mounting holes every 12" (305mm)
- Custom lengths available by special order
- Mounting hardware and screws are NOT included

STANDARD LENGTHS*

TR11-36	36" (914mm)
TR11-48	48" (1219mm)
TR11-60	60" (1524mm)
TR11-72	72" (1828mm)

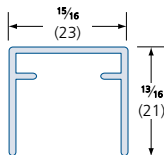

TR21 BI-FOLD TRACK

- Extruded aluminum track, mill finish
- Custom lengths available by special order
- Mounting hardware and screws are NOT included

STANDARD LENGTHS*

TR21-36	36" (914mm)
TR21-48	48" (1219mm)
TR21-60	60" (1524mm)
TR21-72	72" (1828mm)
TR21-84	84" (2133mm)
TR21-96	96" (2438mm)
TR21-120	120" (3048mm)
TR21-144	144" (3658mm)

(*) CUSTOM AND STANDARD LENGTHS CAN VARY BY ±1/8 IN (3 MM)

SLIDING HARDWARE

GENERAL HARDWARE

FASCIA

TRF01B

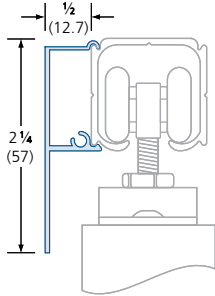

TRF01B SNAP-ON FASCIA

- Extruded aluminum track, clear anodized finish
- For use with #TR01 or #TR02B tracks only
- Improved design for easy installation and removal when track is ceiling mounted
- Custom lengths available by special order
- Mounting hardware and screws are NOT included

STANDARD LENGTHS*

TRF01B-48	48" (1219 mm)
TRF01B-60	60" (1524 mm)
TRF01B-72	72" (1828 mm)
TRF01B-84	84" (2133 mm)
TRF01B-96	96" (2438 mm)
TRF01B-108	108" (2743 mm)
TRF01B-120	120" (3048 mm)
TRF01B-144	144" (3658 mm)

(*) CUSTOM AND STANDARD LENGTHS CAN VARY BY $\pm 1/8$ IN (3 MM)



SLIDING HARDWARE

GENERAL HARDWARE

FASCIA END CAPS

TRFC01, TRFC01D

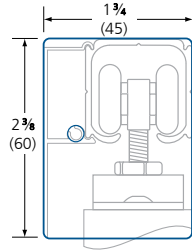

TRFC01S SINGLE END CAP

- Paired aluminum plates, clear anodized finish
- Fits single #TR01 track with #TRF01B fascia on either side
- Mounting screws included

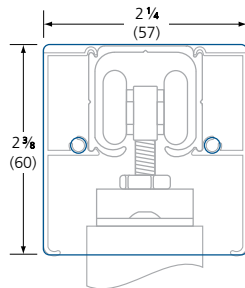

TRFC01D DOUBLE END CAP

- Paired aluminum plates, clear anodized finish
- Fits single #TR01 track with #TRF01B fascia on both sides
- Mounting screws included

FLOOR GUIDES

TRG01, TRG01A, 21-1025-FG

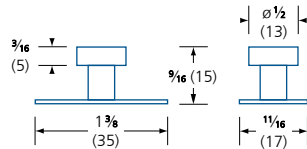
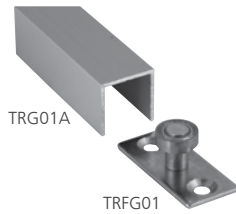

TRFG01 FLOOR GUIDE

- Ball bearing floor guide
- Includes wood screws

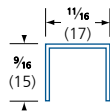

TRG01A FLOOR GUIDE TRACK

- Extruded aluminum track, milled finish
- Available in 72" (1828mm) lengths
- Other cut lengths available by special order

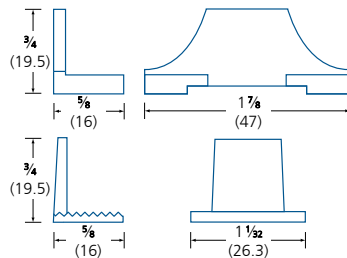

21-1025-FG FLOOR GUIDE

- Nylon floor guide for by-pass applications
- Included with #21-1025 kit
- Includes stop
- Includes wood screws

SLIDING HARDWARE

GENERAL HARDWARE

WALL MOUNT

WM01

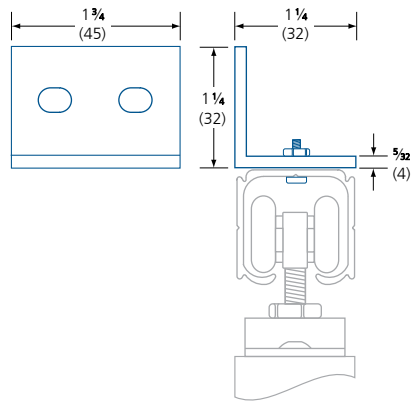

- Extruded aluminum bracket, clear anodized finish
- For use with #TR01 track
- (2) Plastic wall anchors and wood screws included
- (2) Machine screws and nut included
- Multiple mounts are required per track; one per 16" (406 mm) is recommended
- Wall spacers for extra clearance may be required for some installations (not provided; please verify your installation)



WINDOW CATCHES & LATCHES

GENERAL HARDWARE

TRANSOM CATCH

DC25

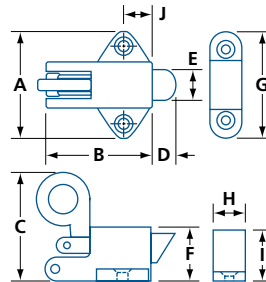
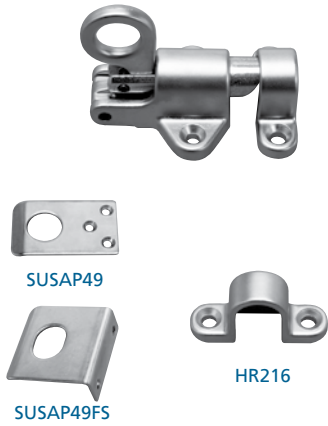

- Spring loaded latch
- Includes keeper
- Optional strikes sold separately
 - #SUSAP49 Flat strike
 - #SUSAP49FS Sash strike
 - #HR216 Replacement keeper

MODEL	FINISH	MATERIAL	A	B	C	D	E	F	G	H	I	J	/BOX
DC25	SL	Zinc die-cast	1 ¹³ / ₁₆ (46)	1 ³ / ₄ (44.5)	1 ³ / ₄ (44.5)	1 ¹³ / ₃₂ (10.3)	1/2 (12.7)	7/8 (22.2)	1 ³ / ₄ (44.5)	1/2 (12.7)	7/8 (22.2)	1/2 (12.7)	20

IN (MM)

TRANSOM CATCH

5215

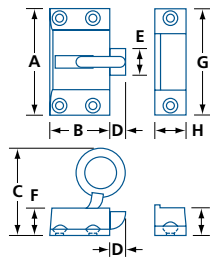
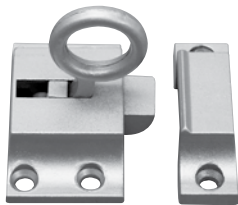

- Spring loaded latch
- Includes keeper
- Mounting hardware included: wood screws

MODEL	FINISH	MATERIAL	A	B	C	D	E	F	G	H	I	/BOX
5215	SL	Zinc die-cast	2 (50.8)	1 ¹ / ₈ (28.6)	1 ⁵ / ₈ (41.3)	5/16 (7.9)	1/2 (12.7)	1/2 (12.7)	2 (50.8)	1 ¹⁹ / ₃₂ (15.1)	1/2 (12.7)	20

IN (MM)

SASH HOOK

DC60



- Zinc die-cast hook
- Chrome plated
- Available with 3/4" (19 mm) diameter, 6 ft. or 12 ft. (1.83 m or 3.66 m) vinyl covered wood pole

MODEL	DESCRIPTION	/BOX
DC60	Hook only, no pole	30
DC60P	Hook with 6 ft. (1.83 m) vinyl covered pole	20
DC60P144	Hook with 12 ft. (3.66 m) vinyl covered pole	10

WINDOW CATCHES & LATCHES

GENERAL HARDWARE

CASEMENT WINDOW HANDLE

DC620T

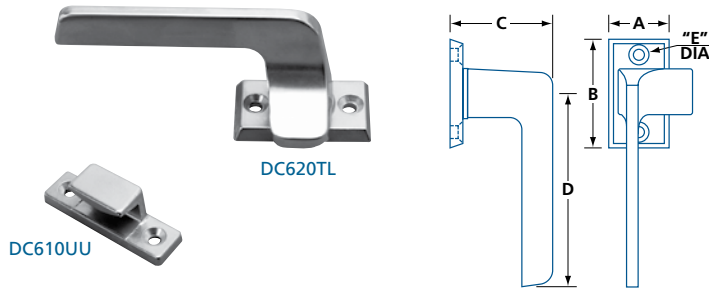

- Zinc die-cast lever
- Handed (left hand shown)
- 90° lever rotation
- Wedge keeper sold separately (#DC610)

MODEL	FINISH	MATERIAL	A	B	C	D	E	/BOX
DC620T	Satin chrome	Zinc die-cast	1 (25.4)	1¾ (44.5)	1⅝ (41.3)	3⅞ (79)	1⅞ (4.4)	20

IN (MM)

SASH LOCK

2832

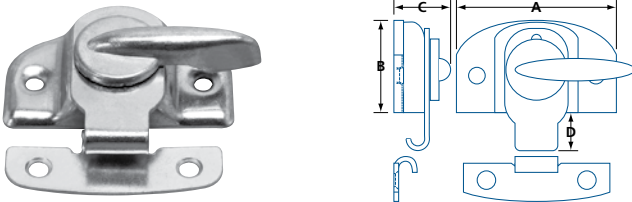

- Steel sash lock
- Spring loaded
- Mounting hardware included: wood screws

MODEL	FINISH	MATERIAL	A	B	C	D	/BOX
2832BP	Brass plated	Steel	2⅞ (60)	1⅞ (34.9)	1⅞ (20.6)	½ (12.7)	20

IN (MM)

WING BUTTON

5101, 5102



- Steel wing button locks
- Zinc plated
- Mounting hardware included: wood screws

MODEL	FINISH	MATERIAL	A	B	/BOX
5101	Zinc plated	Steel	1¾ (44.5)	¾ (19)	300
5102	Zinc plated	Steel	1¼ (31.8)	¾ (19)	300

IN (MM)



WINDOW HARDWARE

GENERAL HARDWARE

CREMONE BOLT SET

41371

- Cremone bolt set for French windows and doors
- High quality cast iron construction
- Set includes: 1 handle, 2 strikes, 1 center guide and 2 end-guides
- Rod sold separately; black finish (#62173EXB)

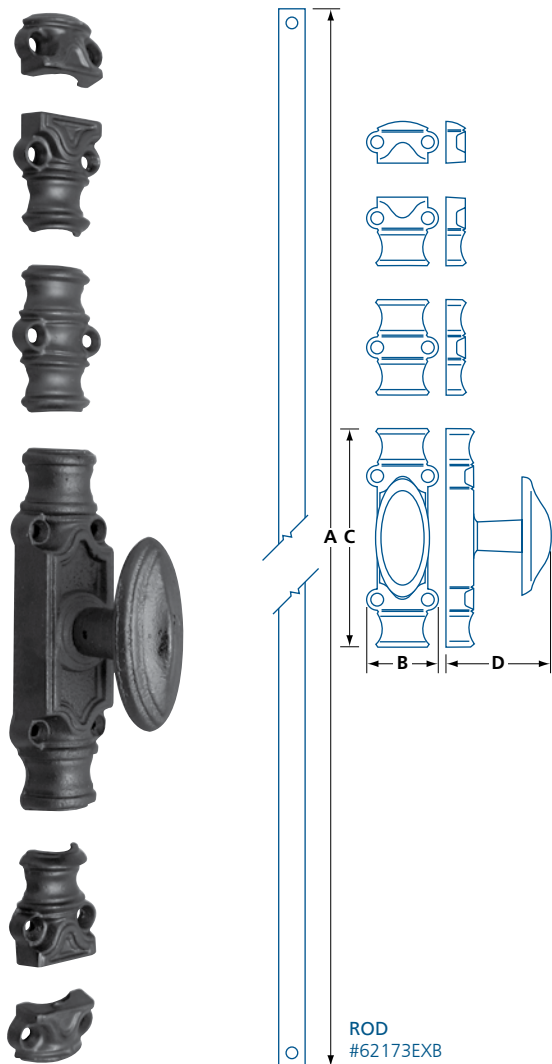

MODEL	FINISH	MATERIAL	A	B	C	D
41371EXB	Black	Cast-iron	51 $\frac{3}{16}$ (1300)	1 $\frac{1}{2}$ (38.1)	5 (127)	2 $\frac{3}{8}$ (60)

IN (MM)