





# TABLE OF CONTENTS SECURITY HARDWARE

---

Finish Guide.....	ii
Abbreviation Guide.....	iii
<b>PADLOCKS &amp; ACCESSORIES</b>	
<b>GUARD</b> Padlocks.....	05.010
Padlocks .....	05.020
<b>VIRO</b> Padlocks.....	05.040
Specialty Padlocks.....	05.060
<b>STOREFRONT HARDWARE</b>	
<b>DOREX</b> Mortise Locks.....	05.200
<b>VIRO</b> Mortise Locks .....	05.210
Door Handles & Paddles.....	05.240
Electric Strikes.....	05.260
<b>CYLINDERS</b>	
Mortise Cylinders .....	05.400
Rim Cylinders.....	05.410
Cylinder Trim Rings.....	05.420
Guards & Latch Protectors.....	05.430
Profile Cylinders.....	05.440
<b>DOOR SECURITY</b>	
Door Viewers.....	05.600
Door Guards & Chains .....	05.610
Rim Locks .....	05.630
Door Protection .....	05.640
<b>ASSORTED SMALL LOCKS</b>	
Cam Locks.....	05.700
<b>KEY ACCESSORIES</b>	
Key Cabinets.....	05.800
Key Rings & Tags .....	05.810





R2026018





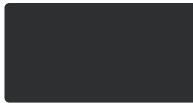

				
PRIME COATED	BLACK JAPANED / LACQ.	MATTE BLACK LACQUER	ZINC PLATED	YELLOW ZINC PLATED
CODE CP	C1B, KJ	C1D	C2G, ZP	C2GY, YZ
BHMA* 600	601	693	603	

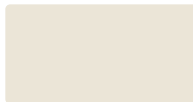

				
POLISHED BRASS	MIRROR POLISHED BRASS	SATIN BRASS	ANTIQUE BRASS	SATIN BRONZE
CODE BP, BP032, C3, 3	C3M, 3M	C4, 4, SDB	AB, C5, 5	C10, 10
BHMA* 605, 632		606, 633	609, 638	612, 639

				
OIL RUBBED BRONZE	POLISHED NICKEL	SATIN NICKEL	ANTIQUÉ NICKEL	MATTE BLACK
CODE C10B, 10B	NP, C14, 14	SDN, SN, C15, 15	AN, C15A, 15A	C19, 19
BHMA* 613, 640	645	619, 646	620, 647	622, 631

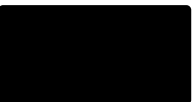
				
DARK BRONZE	POLISHED CHROME	SATIN CHROME	POLISHED STAINLESS STEEL	SATIN STAINLESS STEEL
CODE BLR, DU, C20D, 20D	CHR, C26, 26	SC, C26D, 26D	C32, 32	SS, ST, C32D, 32D
BHMA* 650, 690, 695	625, 651	626, 652	629	630

	
ALUMINUM	PLAIN STEEL, NO FINISH
CODE AL, C28, 28	PS
BHMA* 628, 689	

				
ALMOND WHITE	LIGHT BRONZE	EPOXY BLACK	EPOXY WHITE	SATIN WHITE
CODE ALMOND, AW	BZ	EXB	EXW	WSILK
BHMA*				

			
WHITE	BROWN	SILVER PAINT	GOLD PAINT
CODE WH, WHITE	B	SL	GD
BHMA*			

ALL FINISHES IMAGES ABOVE ARE PHOTOGRAPHIC OR COLOUR APPROXIMATIONS, DELIVERED PRODUCT MAY VARY IN COMPARISON OR BETWEEN ORDERS/LOTS.  
OTHER FINISHES AVAILABLE—PLEASE CONTACT.  
(\*) EQUIVALENT; CODES DIFFER DEPENDING ON BASE MATERIAL AND/OR FINISH PROCESS.

## SECURITY HARDWARE ABBREVIATION GUIDE

---

### GENERAL

BS	Backset
DIA, $\varnothing$	Diameter
KG	Kilograms
LBS	Pounds
LH	Left hand
LHR	Left hand reversed
MAX	Maximum
MIN	Minimum
N/A, —	Not applicable / Not available
QTY	Quantity (usually followed by notes)
RH	Right hand
RHR	Right hand reversed
SQ, $\square$	Square
WT	Weight
/UNIT	Number of items per basic unit of sale (bagged or boxed). The default is 1.
/BOX, /BAG	Number of UNITS found in an inner carton or bag.
/CASE	Number of UNITS found in an outer (shipping) carton.

### CURRENT

AC	Alternating current
DC	Direct current
V	Volts, voltage
A	Amperes
$\Omega$	Ohms

### KEYING

CKD	Completely knocked down
KA	Keyed alike
KA2	Keyed alike in pairs
KD	Keyed different
MK	Master keyed
SA	Sub-assembled
UP	Unpinned

### KEYWAY / CYLINDER TYPE

DM	Dummy
SC	Schlage C
WEI, WR	Weiser
T1	Thumbturn profile 1
Y9	Yale #9

## LEGEND



Tested to Canadian and/or American safety and performance standards by Underwriters Laboratories® (UL).



Tested to Canadian and/or American safety and performance standards by Warnok Hersey/Intertek® (WH).



# GUARD PADLOCKS

## SECURITY HARDWARE

### GUARD SOLID BRASS PADLOCKS

800 SERIES



- Solid brass body, sanded finish
- Hardened steel shackle, chrome plated
- Single or double locking shackle
- Long shackle (L) model available
- Stainless steel springs
- Pick resistant mushroom pins
- Brass cylinder with 2 keys

#### KEYING

- KA: Keyed alike
- KD: Keyed different
- KDC: Retail packaging (keyed different)
- MK: Master keyed
- UP: Unpinned
- Engraving – please contact

\*Keying services available

835L	KA
MODEL	KEYING

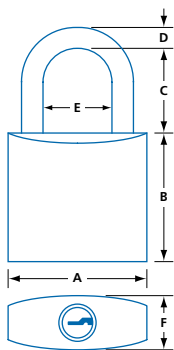

MODEL	SIZE	PINS	KEYING	BODY SIZE			SHACKLE SIZE			QTY <sup>1</sup>
				A	B	F	C	E	ø D	
SINGLE LOCKING										
831	20	3	KA, KD	¾ (19.4)	¾ (20.0)	⅝ (10.9)	½ (11.5)	⅜ (9.6)	⅛ (3.2)	12/576
832	25	4	KA, KD	1 (25.1)	1 (24.3)	½ (11.9)	½ (14.2)	½ (12.6)	⅛ (4.0)	12/324
DOUBLE LOCKING										
833	30	4	KA, KD, UP	1¼ (31.4)	1¼ (30.3)	½ (13.5)	¾ (19.6)	⅝ (16.7)	¼ (5.0)	12/216
834*	40	5	KA, KD, MK, UP	1½ (37.7)	1⅝ (36.5)	⅝ (15.2)	⅞ (22.5)	¾ (19.5)	¼ (6.4)	12/96
834L*	40	5	KA, KD, UP	1½ (37.7)	1⅝ (36.5)	⅝ (15.2)	2½ (63.0)	¾ (19.5)	¼ (6.4)	6/96
835	45	5	KA, KD, UP	1¾ (43.9)	1⅝ (41.4)	⅝ (17.0)	1 (26.5)	⅞ (22.5)	¼ (7.9)	6/72
835L	45	5	KA, KD	1¾ (43.9)	1⅝ (41.4)	⅝ (17.0)	2½ (63.0)	⅞ (22.5)	¼ (7.9)	6/72
836	50	5	KA, KD, MK, UP	2 (50.3)	1¾ (45.6)	¾ (18.5)	1⅝ (28.0)	1 (25.4)	⅜ (9.5)	6/72
836L	50	5	KA, KD	2 (50.3)	1¾ (45.6)	¾ (18.5)	2½ (63.0)	1 (25.4)	⅜ (9.5)	6/48

IN (MM) (1) 12/600 : UNITS PER BOX / UNITS PER CASE. (\*) AVAILABLE WITH CORBIN (A), CISA (C) OR GUARD (V) REVERSE KEYWAYS  
IMPERIAL MEASUREMENTS ARE FOR REFERENCE ONLY, ROUNDED TO NEAREST 1/16"

# GUARD PADLOCKS

## SECURITY HARDWARE

### GUARD LAMINATED PADLOCKS

700 SERIES



- Laminated steel plate body
- Hardened steel shackle, chrome plated
- Single or double locking shackle
- Stainless steel springs
- Pick resistant mushroom pins
- Brass cylinder with 2 keys

#### KEYING

- KA: Keyed alike
- KD: Keyed different
- KDC: Retail packaging (keyed different)

\*Keying services available

740	KD
MODEL	KEYING

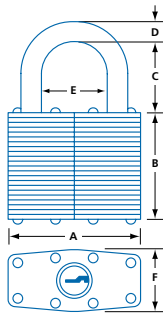

MODEL	SIZE	PINS	KEYING	BODY SIZE			SHACKLE SIZE			QTY <sup>1</sup>
				A	B	F	C	E	ø D	
SINGLE LOCKING										
730	30	3	KA, KD	1 <sup>31</sup> / <sub>32</sub> (50.0)	1 <sup>9</sup> / <sub>16</sub> (40.0)	1 <sup>11</sup> / <sub>16</sub> (17.5)	1 <sup>3</sup> / <sub>32</sub> (27.5)	1 <sup>5</sup> / <sub>32</sub> (29.5)	1 <sup>11</sup> / <sub>16</sub> (17.5)	12/216
DOUBLE LOCKING										
740	40	5	KA, KD	2 <sup>3</sup> / <sub>8</sub> (60.0)	1 <sup>13</sup> / <sub>16</sub> (46.0)	7 <sup>7</sup> / <sub>8</sub> (20.5)	1 <sup>15</sup> / <sub>32</sub> (37.5)	1 <sup>3</sup> / <sub>8</sub> (35.0)	7 <sup>7</sup> / <sub>8</sub> (20.5)	12/96
744	45	5	KA, KD	1 <sup>9</sup> / <sub>16</sub> (40.0)	1 <sup>5</sup> / <sub>16</sub> (33.0)	2 <sup>1</sup> / <sub>32</sub> (16.5)	2 <sup>9</sup> / <sub>32</sub> (23.0)	1 <sup>5</sup> / <sub>16</sub> (24.0)	2 <sup>1</sup> / <sub>32</sub> (16.5)	12/96
750	50	5	KA, KD	1 <sup>31</sup> / <sub>32</sub> (50.0)	1 <sup>9</sup> / <sub>16</sub> (40.0)	1 <sup>11</sup> / <sub>16</sub> (17.5)	1 <sup>3</sup> / <sub>32</sub> (27.5)	1 <sup>5</sup> / <sub>32</sub> (29.5)	1 <sup>11</sup> / <sub>16</sub> (17.5)	6/72

IN (MM) (1) 12/216 : UNITS PER BOX / UNITS PER CASE. IMPERIAL MEASUREMENTS ARE FOR REFERENCE ONLY, ROUNDED TO NEAREST 1/8"

### GUARD MARINE PADLOCKS – LONG SHACKLE

936L



- Solid brass body, chrome finish
- Stainless steel shackle
- Double locking long shackle
- Stainless steel springs
- Pick resistant mushroom pins
- Includes 2 keys

#### KEYING

- KA: Keyed alike
- KD: Keyed different

\*Keying services available

963L	KD
MODEL	KEYING

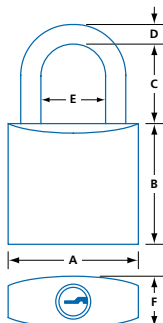

MODEL	SIZE	PINS	KEYING	BODY SIZE			SHACKLE SIZE			QTY <sup>1</sup>
				A	B	F	C	E	ø D	
DOUBLE LOCKING										
936L	50	5	KD	2 (49.9)	1 <sup>5</sup> / <sub>8</sub> (40.2)	5 <sup>5</sup> / <sub>8</sub> (16.8)	3 <sup>1</sup> / <sub>2</sub> (88.0)	1 <sup>1</sup> / <sub>8</sub> (29.0)	1 <sup>1</sup> / <sub>4</sub> (7.9)	6/48

IN (MM) (1) 6/48 : UNITS PER BOX / UNITS PER CASE. IMPERIAL MEASUREMENTS ARE FOR REFERENCE ONLY, ROUNDED TO NEAREST 1/8"



# GUARD PADLOCKS

SECURITY HARDWARE

## GUARD<sup>®</sup> PADLOCK KEYING PARTS

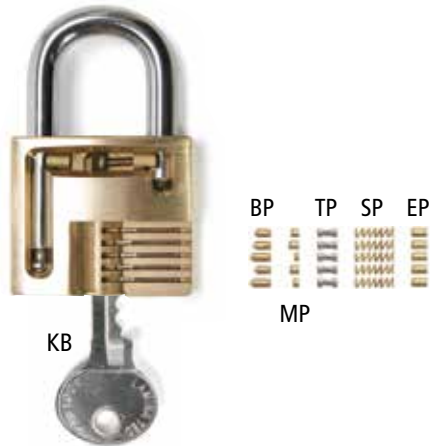

PART	SPECIFICATION	PIN #
BP	833	-1

### PARTS

BP: Bottom pin  
 MP: Master pin  
 TP: Top pin  
 SP: Spring  
 EP: End plug

### SPECIFICATION

832: 832 padlock  
 833: 833 padlock  
 834-35: 834/35 padlock  
 836: padlock

### PIN #

-1: Pin #1  
 -2: Pin #2  
 -3: Pin #3  
 -4: Pin #4  
 -5: Pin #5

KEY	SPECIFICATION	KEYWAY
KB	834-35	A

### KEY

KB: Key blank  
 MK: Master key

### SPECIFICATION

730: 730 padlock  
 740: 740 padlock  
 744-50: 740/750 padlock  
 831: 831 padlock  
 832: 832 padlock  
 833: 833 padlock  
 834-35: 834/35 padlock  
 836: padlock

### KEYWAY\*

A: Corbin  
 C: Cisa  
 V: Guard (reverse)

\*Optional keyways ONLY available for 834 or 834L padlocks.



# BRASS PADLOCKS

## SECURITY HARDWARE

### SOLID BRASS PADLOCKS



- Solid brass body, polished finish
- Hardened steel shackle, nickel plated
- Single or double locking shackle
- Long shackle (L) models available
- Re-keyable cylinder with 3 keys

#### KEYING

KD: Keyed alike

\*Keying services available

263L	KD
MODEL	KEYING

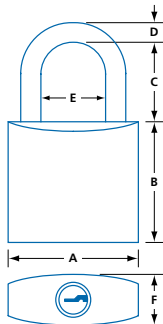

MODEL	SIZE	PIN	KEYING	BODY SIZE			SHACKLE SIZE			KEY <sup>1</sup>	/BOX
				A	B	F	C	E	øD		
SINGLE LOCKING											
261	20	3	KD	1 <sup>3</sup> / <sub>16</sub> (20.6)	2 <sup>5</sup> / <sub>32</sub> (19.5)	1 <sup>3</sup> / <sub>32</sub> (10.4)	1 <sup>3</sup> / <sub>32</sub> (10.5)	1 <sup>3</sup> / <sub>32</sub> (10.7)	1/8 (3.2)	KB261	12
262	25	4	KD	3 <sup>1</sup> / <sub>32</sub> (24.9)	3 <sup>1</sup> / <sub>32</sub> (24.8)	1 <sup>5</sup> / <sub>32</sub> (12.1)	3 <sup>1</sup> / <sub>32</sub> (24.8)	1/2 (12.5)	3/16 (4.4)	KB262	6
DOUBLE LOCKING											
263	32	4	KD	1 <sup>1</sup> / <sub>4</sub> (31.6)	1 <sup>3</sup> / <sub>16</sub> (30.0)	9/16 (13.9)	1 <sup>3</sup> / <sub>16</sub> (30.0)	2 <sup>1</sup> / <sub>32</sub> (16.8)	7/32 (5.4)	KB263	6
263L	32	5	KD	1 <sup>1</sup> / <sub>4</sub> (31.6)	1 <sup>3</sup> / <sub>16</sub> (30.0)	9/16 (13.9)	1 <sup>3</sup> / <sub>16</sub> (30.0)	2 <sup>1</sup> / <sub>32</sub> (16.8)	7/32 (5.4)	KB263	6
264	38	5	KD	1 <sup>1</sup> / <sub>2</sub> (37.8)	1 <sup>3</sup> / <sub>8</sub> (35.0)	5/8 (15.6)	1 <sup>3</sup> / <sub>8</sub> (35.0)	2 <sup>5</sup> / <sub>32</sub> (19.7)	1/4 (6.3)	KB263	6
264L	38	5	KD	1 <sup>1</sup> / <sub>2</sub> (37.8)	1 <sup>3</sup> / <sub>8</sub> (35.0)	5/8 (15.6)	1 <sup>3</sup> / <sub>8</sub> (35.0)	2 <sup>5</sup> / <sub>32</sub> (19.7)	1/4 (6.3)	KB263	6
265	50	6	KD	1 <sup>31</sup> / <sub>32</sub> (49.8)	1 <sup>11</sup> / <sub>16</sub> (42.9)	3/4 (19.1)	1 (25.0)	1 (25.4)	1 <sup>11</sup> / <sub>32</sub> (8.7)	KB265	6

IN (MM)

(1) INDICATE HANDING WHEN ORDERING KEY BLANKS

# IRON PADLOCKS

## SECURITY HARDWARE

### SOLID IRON PADLOCKS



- Solid iron body
- Hardened steel shackle, nickel plated
- Solid brass internal parts
- Single or double locking
- Key removable in both locked and unlocked position
- 2 keys supplied with models 361 and 362
- 3 keys supplied with models 363 to 367

#### KEYING

KD: Keyed alike

\*Keying services available

263L	KA
MODEL	KEYING

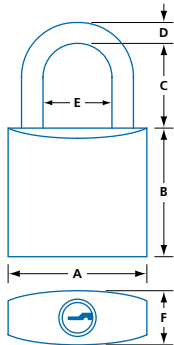

MODEL	SIZE	PINS	BODY SIZE			SHACKLE SIZE			KEY <sup>1</sup>	/BOX
			A	B	F	C	E	∅D		
DOUBLE LOCKING										
363	32	5	1¼ (32.0)	1¾/16 (30.0)	19/32 (15.0)	19/64 (5.2)	5/8 (16.0)	13/64 (5.2)	KB263	6
364	38	5	1½ (38.0)	1¾/8 (35.0)	11/16 (17.0)	¼ (6.3)	¾ (19.0)	¼ (6.3)	KB263	6
365	50	6	2 (51.0)	11¼/16 (43.0)	23/32 (18.4)	11/32 (8.8)	1 (25.0)	11/32 (8.8)	KB265	6

IN (MM)

(1) INDICATE HANDING WHEN ORDERING KEY BLANKS



# VIRO PADLOCKS

## SECURITY HARDWARE

### Viro SOLID BRASS PADLOCKS



- Solid brass body, sanded finish
- Hardened steel shackle, nickel plated
- Solid brass cylinder, bolts and pins
- Stainless steel springs
- Key removable in locked or unlocked position
- Includes 2 nickel plated brass keys

#### OPTIONS

- KD:** Keyed different (LH default)
- SA:** Sub-assembled, indicate keyway handing (RH/LH)
- CKD:** Completely knocked down, indicate keyway handing (RH/LH)

\*Keying services available

302	KD
MODEL	KEYING

Wide variety of padlocks and specialty locks available  
– please contact to order or visit [www.viro.it](http://www.viro.it) for details

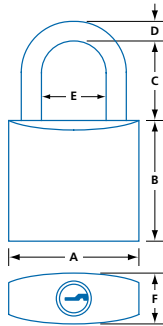

MODEL	SIZE	PINS	BODY SIZE			SHACKLE SIZE*			KEYING	QTY <sup>1</sup>
			A	B	F	C	E	∅D		
301	30	4	30.0	27.0	13.0	15.0	15.7	5.0	KD, SA, CKD	12
302	40	5	40.0	32.0	15.0	20.0	23.0	6.4	KD, SA, CKD	12
303	50	5	50.0	40.0	17.0	28.0	30.0	8.0	KD, SA, CKD	6
304	60	5	60.0	46.0	20.0	35.0	35.0	10.0	KD, SA, CKD	6
305	70	5	70.0	51.0	23.0	42.0	38.0	12.0	KD, SA	6

MM

(1) 12 : UNITS PER CASE

(\*) OPTIONAL SHACKLE LENGTHS AVAILABLE – SEE AVAILABILITY CHART BELOW



MODEL	SIZE	SHACKLE SIZE			VIRO KEYWAY	KEY <sup>1</sup>
		C	E	∅D		
301.30		30.0	15.7	5.0		
301.40	30	40.0	15.7	5.0	011	301KB
301.64		64.0	15.7	5.0		
302.40		40.0	23.0	6.4		
302.64	40	64.0	23.0	6.4	013	302KB
302.90		90.0	23.0	6.4		
303.48		40.0	30.0	8.0		
303.64	50	64.0	30.0	8.0	015	302KB
303.90		90.0	30.0	8.0		
304.64	60	64.0	35.0	10.0	015	302KB
304.90		90.0	35.0	10.0		
305.64	70	64.0	38.0	12.0	015	302KB
305.90		90.0	38.0	12.0		

MM

PLEASE CONTACT REPRESENTATIVE FOR HELP ORDERING CUSTOM PADLOCKS OR SHACKLES

(1) KEY BLANKS AVAILABLE SEPARATELY



# SPECIALTY PADLOCKS

## SECURITY HARDWARE

**Viro** ARMoured PADLOCKS

PANZER, MONOLITH



4115 / 4116 / 4117

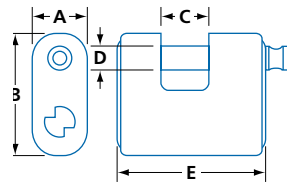

4125 / 4126

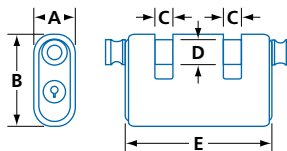

### PANZER

- Solid forged brass one-piece padlock
- Chrome plated case-hardened steel main and side armour
- Chrome plated case-hardened steel anti-drill and pull resistant plate protecting the plug
- Case-hardened steel rotating lock bolt
- Lockbolt security protected by break-off handle if forced
- Mechanism: key-retaining, ball-type locking
- Cylinder: 7-pin Viro039 keyway, re-keyable
- Supplied with 3 nickel plated brass keys
- Parts and pins available-please contact

Wide variety of padlocks and specialty locks available – please contact to order or visit [www.viro.it](http://www.viro.it) for details



4117KB039

Nickel plated  
brass key blank

MODEL	KEYING	SIZE	KEYWAY	A	B	C	∅ D	E	/BOX
4115	KD	62	039RH	$\frac{29}{32}$ (23)	2 (51)	$\frac{25}{32}$ (20)	$\frac{13}{32}$ (10)	$\frac{27}{16}$ (62)	1
4116	KD	77	039RH	$\frac{15}{32}$ (29)	$\frac{27}{16}$ (62)	$\frac{1}{16}$ (27)	$\frac{15}{32}$ (12)	$\frac{31}{32}$ (77)	1
4117	KD	86	039RH	$\frac{15}{32}$ (29)	$\frac{27}{32}$ (72)	$\frac{113}{32}$ (36)	$\frac{15}{32}$ (12)	$\frac{33}{8}$ (86)	1
4125	KD	78	039RH	$\frac{29}{32}$ (23)	2 (51)	$\frac{13}{32}$ (10)	$\frac{13}{32}$ (10)	$\frac{31}{16}$ (78)	1
4126	KD	86	039RH	$\frac{15}{32}$ (29)	$\frac{27}{16}$ (62)	$\frac{7}{16}$ (11.5)	$\frac{15}{32}$ (12)	$\frac{33}{8}$ (86)	1

IN (MM)



4143 / 4144

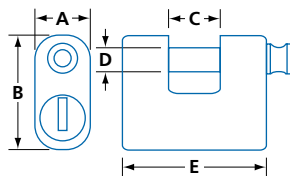

### MONOLITH

- One-piece, special case-hardened and tempered steel body, corrosion-resistant nickel plating
- Case-hardened and tempered steel rotating lockbolt
- Lockbolt security protected by break-off handle if forced
- 7-pin security system, replaceable and rekeyable, protected by a rotating anti-drill plate in special case-hardened, tempered  $\frac{3}{16}$ " (4.4 mm) thick steel
- Supplied with 2 nickel plated brass keys

MODEL	KEYING	SIZE	KEYWAY	A	B	C	∅ D	E	/BOX
4143	KD	78	039RH	$\frac{13}{16}$ (30)	$\frac{27}{16}$ (62)	$\frac{13}{32}$ (28)	$\frac{1}{2}$ (13)	$\frac{31}{16}$ (78)	1
4144	KD	87	039RH	$\frac{13}{16}$ (30)	$\frac{23}{4}$ (70)	$\frac{115}{32}$ (37)	$\frac{1}{2}$ (13)	$\frac{37}{16}$ (87)	1

IN (MM)



# DOREX MORTISE LOCKS

SECURITY HARDWARE

## DOREX DL2400 DEADLATCH LOCK

DL24

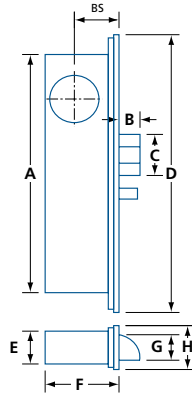

- Heavy zinc plated steel construction
- Chrome plated latch bolt with Delrin insert for smooth, quiet latching
- ½" (12.7 mm) latch throw
- Zinc alloy dead locking pin
- Left or right handed, field reversible
- Cylinder backset: ¾" (24.6 mm) or 1 ⅛" (28.6 mm)
- Lock accepts standard 1 ½" (29.4 mm) diameter mortise cylinder with cam A (Adams Rite type)
- Key or turn-button controlled latch dogging
- Radius anodized aluminum (#FP32) faceplate included
- Strike not included
- Other faceplates, strikes, and accessories available, see page 05.203

MODEL	FINISH	HANDING	BS	A	B	C	D	E	F	G	H	/CASE
DL2412-2	AL, DU	LH	¾" (24.6)	5 27/32" (148.1)	½" (12.7)	1 (25.3)	6 7/8" (174.6)	7/8" (22.2)	1 5/8" (41.3)	5/8" (16.2)	1 (25.4)	25
DL2422-2	AL, DU	RH										
DL2413-2	AL, DU	LH	1 ⅛" (28.6)	5 27/32" (148.1)	½" (12.7)	1 (25.3)	6 7/8" (174.6)	7/8" (22.2)	1 ¾" (44.5)	5/8" (16.2)	1 (25.4)	25
DL2423-2	AL, DU	RH										

IN (MM)

## DOREX DL2500 DEADLATCH LOCK – HEAVY DUTY

DL25

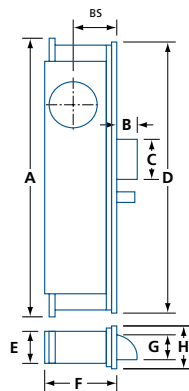

- Heavy zinc plated steel construction
- Adjustable mounting studs for easy lock alignment
- Solid zinc alloy latch bolt with ½" (12.7 mm) throw
- Zinc alloy dead locking pin
- Left or right handed, field reversible
- Cylinder backset: ¾" (24.6 mm) or 1 ⅛" (28.6 mm)
- Lock accepts standard 1 ½" (29.4 mm) diameter mortise cylinder with cam A (Adams Rite type)
- Key or turn-button controlled latch dogging
- Radius anodized aluminum (#FP32) faceplate included
- Strike not included
- Other faceplates, strikes, and accessories available, see page 05.203

MODEL	FINISH	HANDING	BS	A	B	C	D	E	F	G	H	/CASE
DL2512-2	AL, DU	LH	¾" (24.6)	7 (177.8)	½" (12.7)	1 (25.4)	6 7/8" (174.6)	7/8" (22.5)	1 19/32" (40.6)	5/8" (15.7)	1 (25.4)	25
DL2522-2	AL, DU	RH										
DL2513-2	AL, DU	LH	1 ⅛" (28.6)	7 (177.8)	½" (12.7)	1 (25.4)	6 7/8" (174.6)	7/8" (22.5)	1 ¾" (44.5)	5/8" (15.7)	1 (25.4)	25
DL2523-2	AL, DU	RH										

IN (MM)

# DOREX MORTISE LOCKS

## SECURITY HARDWARE

### DOREX DB2100 DEADBOLT LOCK

DB21

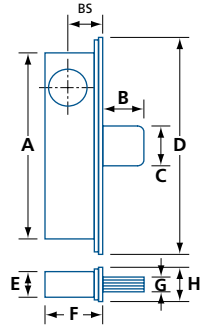

- Heavy zinc plated steel construction
- 5-ply laminated steel pivot bolt with 3 case-hardened center plies plus hardened roll pin (sawing test meets ANSI performance specifications)
- 1<sup>3</sup>/<sub>8</sub>" (35.1 mm) bolt throw
- Non-handed
- Cylinder backset: 7<sup>7</sup>/<sub>8</sub>" (22.2 mm), 3<sup>1</sup>/<sub>2</sub>" (24.6 mm) or 1<sup>1</sup>/<sub>8</sub>" (28.6 mm)
- Lock accepts standard 1<sup>5</sup>/<sub>32</sub>" (29.4 mm) diameter mortise cylinder with cam A (Adams Rite type)
- Flat anodized aluminum (#FP11) faceplate included
- Strike not included
- Other faceplates, strikes, and accessories available, see page 05.203

MODEL	FINISH	BS	A	B	C	D	E	F	G	H	/CASE
DB2101-1	AL, DU	7 <sup>7</sup> / <sub>8</sub> (22.2)	6 (152.7)	1 <sup>3</sup> / <sub>8</sub> (35.1)	1 <sup>3</sup> / <sub>8</sub> (34.4)	6 <sup>7</sup> / <sub>8</sub> (174.6)	2 <sup>9</sup> / <sub>32</sub> (22.8)	1 <sup>19</sup> / <sub>32</sub> (40.0)	5 <sup>5</sup> / <sub>8</sub> (15.3)	1 (25.4)	25
DB2102-1	AL, DU	3 <sup>1</sup> / <sub>2</sub> (24.6)	6 (152.7)	1 <sup>3</sup> / <sub>8</sub> (35.1)	1 <sup>3</sup> / <sub>8</sub> (34.4)	6 <sup>7</sup> / <sub>8</sub> (174.6)	2 <sup>9</sup> / <sub>32</sub> (22.8)	1 5/8 (41.2)	5 <sup>5</sup> / <sub>8</sub> (15.3)	1 (25.4)	25
DB2103-1	AL, DU	1 <sup>1</sup> / <sub>8</sub> (28.6)	6 (152.7)	1 <sup>3</sup> / <sub>8</sub> (35.1)	1 <sup>3</sup> / <sub>8</sub> (34.4)	6 <sup>7</sup> / <sub>8</sub> (174.6)	2 <sup>9</sup> / <sub>32</sub> (22.8)	1 25/32 (45.1)	5 <sup>5</sup> / <sub>8</sub> (15.3)	1 (25.4)	25

IN (MM)

### DOREX DB2200 DEADBOLT LOCK – SHORT THROW

DB22

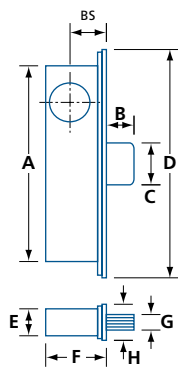

- Heavy zinc plated steel construction
- 5-ply laminated steel pivot bolt with 3 case-hardened center plies plus hardened roll pin (sawing test meets ANSI performance specifications)
- 1<sup>3</sup>/<sub>16</sub>" (20.5 mm) bolt throw
- Non-handed
- Cylinder backset: 3<sup>1</sup>/<sub>2</sub>" (24.6 mm) or 1<sup>1</sup>/<sub>8</sub>" (28.6 mm)
- Lock accepts standard 1<sup>5</sup>/<sub>32</sub>" (29.4 mm) diameter mortise cylinder with cam A (Adams Rite type)
- Flat anodized aluminum (#FP21) faceplate included
- Strike not included
- Other faceplates, strikes, and accessories available, see page 05.203

MODEL	FINISH	BS	A	B	C	D	E	F	G	H	/CASE
DB2202-1	AL, DU	3 <sup>1</sup> / <sub>2</sub> (24.6)	6 (152.7)	1 <sup>3</sup> / <sub>16</sub> (20.5)	1 <sup>11</sup> / <sub>32</sub> (34.1)	6 <sup>7</sup> / <sub>8</sub> (174.6)	2 <sup>9</sup> / <sub>32</sub> (22.9)	1 <sup>5</sup> / <sub>8</sub> (41.4)	5 <sup>5</sup> / <sub>8</sub> (15.3)	1 (25.4)	25
DB2203-1	AL, DU	1 <sup>1</sup> / <sub>8</sub> (28.6)	6 (152.7)	1 <sup>3</sup> / <sub>16</sub> (20.5)	1 <sup>11</sup> / <sub>32</sub> (34.1)	6 <sup>7</sup> / <sub>8</sub> (174.6)	2 <sup>9</sup> / <sub>32</sub> (22.9)	1 <sup>25</sup> / <sub>32</sub> (45.1)	5 <sup>5</sup> / <sub>8</sub> (15.3)	1 (25.4)	25

IN (MM)



# DOREX MORTISE LOCKS

SECURITY HARDWARE

## DOREX HB2300 HOOKBOLT LOCK

HB23

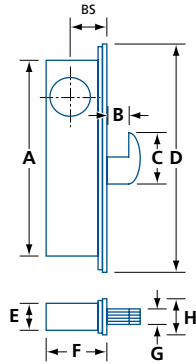

- Heavy zinc plated steel construction
- 5-ply laminated steel pivot bolt with 3 case-hardened center plies plus hardened roll pin (sawing test meets ANSI performance specifications)
- $1\frac{9}{16}$ " (20.5 mm) bolt throw
- Non-handed
- Cylinder backset:  $\frac{31}{32}$ " (24.6 mm) or  $1\frac{1}{8}$ " (28.6 mm)
- Lock accepts standard  $1\frac{5}{32}$ " (29.4 mm) diameter mortise cylinder with cam A (Adams Rite type)
- Flat anodized aluminum (#FP21) faceplate included
- Strike not included
- Other faceplates, strikes, and accessories available, see page 05.203

MODEL	FINISH	BS	A	B	C	D	E	F	G	H	/CASE
HB2302-1	AL, DU	$\frac{31}{32}$ (24.6)	6 (152.7)	$\frac{17}{32}$ (13.4)	$1\frac{1}{4}$ (31.8)	$\frac{67}{8}$ (174.6)	$\frac{29}{32}$ (22.9)	$1\frac{5}{8}$ (41.4)	$\frac{5}{8}$ (15.3)	1 (25.4)	25
HB2303-1	AL, DU	$1\frac{1}{8}$ (28.6)	6 (152.7)	$\frac{17}{32}$ (13.4)	$1\frac{1}{4}$ (31.8)	$\frac{67}{8}$ (174.6)	$\frac{29}{32}$ (22.9)	$1\frac{25}{32}$ (45.1)	$\frac{5}{8}$ (15.3)	1 (25.4)	25

IN (MM)

# DOREX MORTISE LOCKS

## SECURITY HARDWARE

### DOREX MORTISE LOCK FACEPLATES

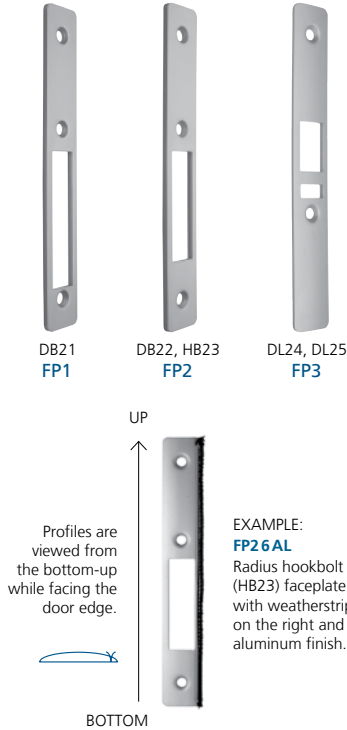

SERIES	PROFILE	DESCRIPTION	MODEL	FINISH	/CASE
DB21	1	Flat 6 $\frac{7}{8}$ x1 (174.6x25.4)	FP11	AL DU	25
HB23, DB22			FP21		
DL24, DL25			FP31		
DB21	3	Bevelled, left 6 $\frac{7}{8}$ x1 (174.6x25.4)	FP13	AL DU	25
HB23, DB22			FP23		
DL24, DL25			FP33		
DB21	4	Bevelled, right 6 $\frac{7}{8}$ x1 (174.6x25.4)	FP14	AL DU	25
HB23, DB22			FP24		
DL24, DL25			FP34		
DB21	2	Radius 6 $\frac{7}{8}$ x1 (174.6x25.4)	FP12	AL DU	25
HB23, DB22			FP22		
DL24, DL25			FP32		
DB21	5	Radius, weatherstrip left 6 $\frac{7}{8}$ x1 (174.6x25.4)	FP15	AL DU	25
HB23, DB22			FP25		
DL24, DL25			FP35		
DB21	6	Radius, weatherstrip right 6 $\frac{7}{8}$ x1 (174.6x25.4)	FP16	AL DU	25
HB23, DB22			FP26		
DL24, DL25			FP36		

IN (MM) ALL FACEPLATES ARE ANODIZED ALUMINUM

### DOREX MORTISE LOCK GUARDS

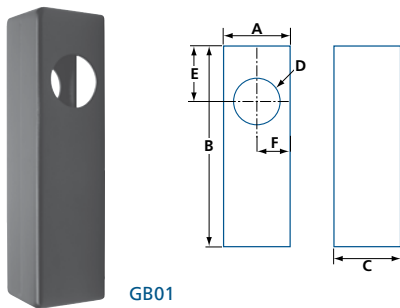

#### GB01 GUARD BOX

- Heavy gauge steel guard box for DB or HB series for added protection
- Accepts standard 1 $\frac{1}{8}$ " (28.6mm) backset mortise deadbolt or hookbolt with 1 $\frac{5}{32}$ " (29.4 mm) diameter mortise cylinder

MODEL	A	B	C	D	E	F
GB01	1 $\frac{31}{32}$ (50)	7 (177.8)	1 $\frac{3}{4}$ (44.5)	1 $\frac{1}{4}$ (31.8)	1 $\frac{11}{16}$ (42.9)	2 $\frac{7}{32}$ (21.4)

IN (MM)

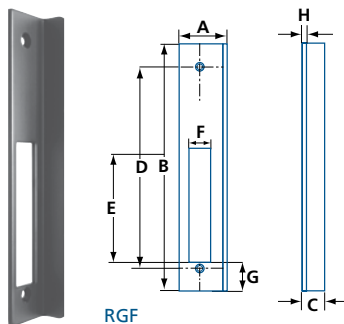

#### LGf/RGf FACEPLATE GUARD

- Heavy gauge steel faceplate guard provides added protection
- Used with guard box #GB01

MODEL	A	B	C	D	E	F	G	H
LGf/RGf	1 $\frac{1}{4}$ (31.8)	6 $\frac{7}{8}$ (174.6)	5 $\frac{5}{8}$ (15.9)	5 $\frac{5}{8}$ (142.9)	3 $\frac{3}{16}$ (80.9)	5 $\frac{5}{8}$ (15.9)	1 $\frac{3}{16}$ (20.6)	1 $\frac{1}{8}$ (3.2)

IN (MM)



# DOREX MORTISE LOCKS

SECURITY HARDWARE

## DOREX MORTISE LOCK STRIKES



### LS01 DL STRIKE

- Standard flat stainless steel deadlatch strike
- Includes dustbox, mounting plate and machine screws

### LS02 DL STRIKE

- Flat reversible stainless steel deadlatch strike (used when converting to DL series from door prepped for DB or HB series)
- Includes black plastic dust box, steel mounting plate and machine screws



### DBSTR DB STRIKE

- Heavy duty zinc plated deadbolt strike

### HBSTR HB STRIKE

- Heavy duty zinc plated hookbolt strike

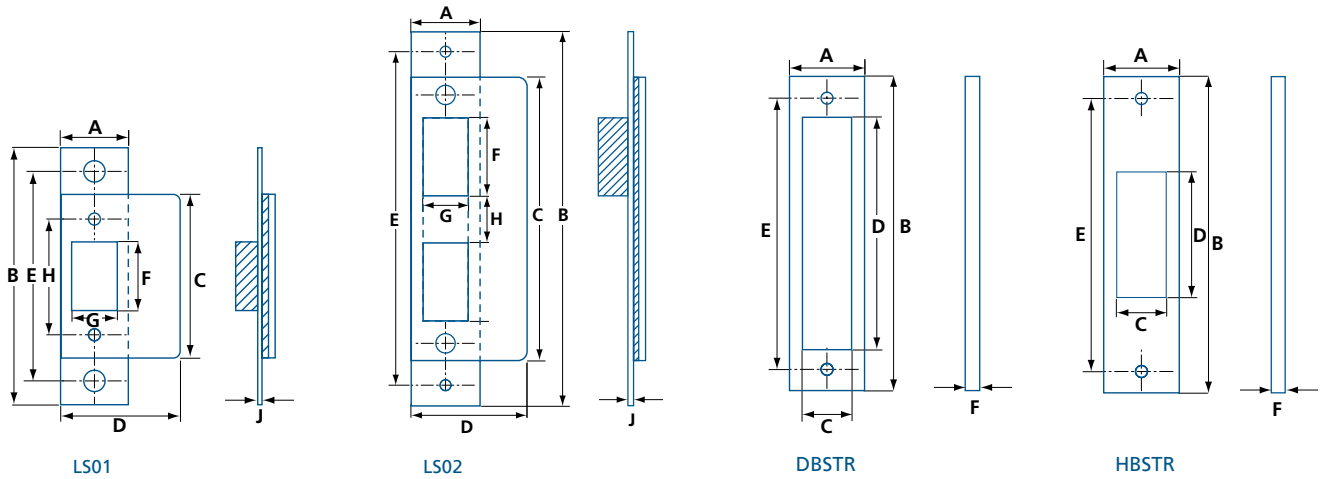

MODEL	A	B	C	D	E	F	G	H	J
LS01	1 $\frac{1}{8}$ (28.6)	4 $\frac{9}{64}$ (105)	2 $\frac{5}{8}$ (66.7)	1 $\frac{29}{32}$ (48.4)	3 $\frac{3}{4}$ (85.7)	1 $\frac{1}{8}$ (28.6)	$\frac{3}{4}$ (19.1)	1 $\frac{7}{8}$ (47.6)	$\frac{3}{32}$ (2.4)
LS02	1 $\frac{1}{8}$ (28.6)	6 $\frac{3}{32}$ (154.7)	4 $\frac{5}{8}$ (117.5)	1 $\frac{29}{32}$ (48.4)	5 $\frac{3}{8}$ (136.5)	1 $\frac{1}{8}$ (28.6)	$\frac{3}{4}$ (19.1)	$\frac{7}{8}$ (22.2)	$\frac{3}{32}$ (2.4)
DBSTR	1 $\frac{3}{16}$ (30.2)	4 $\frac{7}{8}$ (47.6)	$\frac{5}{8}$ (15.9)	3 $\frac{3}{8}$ (85.7)	4 $\frac{1}{16}$ (103.2)	$\frac{1}{8}$ (3.2)	—	—	—
HBSTR	1 $\frac{3}{16}$ (30.2)	4 $\frac{7}{8}$ (47.6)	$\frac{5}{8}$ (15.9)	1 $\frac{5}{8}$ (41.3)	4 $\frac{1}{16}$ (103.2)	$\frac{1}{8}$ (3.2)	—	—	—

IN (MM)



# VIRO MORTISE LOCKS

SECURITY HARDWARE

## VIRO DEADLATCH LOCK

8516, 8517, 8518, 8519

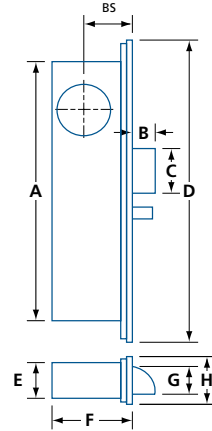

- Heavy galvanized steel construction
- Solid zinc alloy latch bolt
- Zinc alloy dead locking pin with ball bearing tip
- $1\frac{7}{32}$ " (13.6 mm) latch throw
- Reversible
- Cylinder backset:  $\frac{7}{8}$ " (22.2 mm),  $\frac{31}{32}$ " (24.6 mm),  $1\frac{1}{8}$ " (28.6 mm) or  $1\frac{1}{2}$ " (38.1 mm)
- Lock accepts standard  $1\frac{5}{32}$ " (29.4 mm) diameter mortise cylinder with cam A (Adams Rite type)
- Key or turn-button controlled latch dogging
- Faceplate #9902C28 sold separately

Wide variety of padlocks and specialty locks available – please contact to order or visit [www.viro.it](http://www.viro.it) for details

MODEL	BS	A	B	C	D	E	F	G	H
8516	$\frac{7}{8}$ (22.2)	$5\frac{13}{16}$ (147.3)	$\frac{17}{32}$ (13.6)	1 (25.3)	$6\frac{7}{8}$ (174.9)	$\frac{7}{8}$ (22.4)	$1\frac{1}{2}$ (38.2)	$\frac{5}{8}$ (16.0)	1 (25.2)
8517	$\frac{31}{32}$ (24.6)	$5\frac{13}{16}$ (147.3)	$\frac{17}{32}$ (13.6)	1 (25.3)	$6\frac{7}{8}$ (174.9)	$\frac{7}{8}$ (22.4)	$1\frac{19}{32}$ (40.6)	$\frac{5}{8}$ (16.0)	1 (25.2)
8518	$1\frac{1}{8}$ (28.6)	$5\frac{13}{16}$ (147.3)	$\frac{17}{32}$ (13.6)	1 (25.3)	$6\frac{7}{8}$ (174.9)	$\frac{7}{8}$ (22.4)	$1\frac{3}{4}$ (44.6)	$\frac{5}{8}$ (16.0)	1 (25.2)
8519	$1\frac{1}{2}$ (38.1)	$5\frac{13}{16}$ (147.3)	$\frac{17}{32}$ (13.6)	1 (25.3)	$6\frac{7}{8}$ (174.9)	$\frac{7}{8}$ (22.4)	$2\frac{1}{8}$ (54.1)	$\frac{5}{8}$ (16.0)	1 (25.2)

IN (MM)

## VIRO DEADBOLT LOCK

8506, 8507, 8508

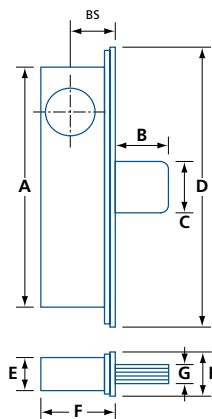

- Heavy galvanized steel construction
- Tough laminated swinging deadbolt
- $1\frac{3}{8}$ " (34.9 mm) latch throw
- Non-handed
- Cylinder backset:  $\frac{7}{8}$ " (22.2 mm),  $\frac{31}{32}$ " (24.6 mm), or  $1\frac{1}{8}$ " (28.6 mm)
- Lock accepts standard  $1\frac{5}{32}$ " (29.4 mm) diameter mortise cylinder with cam A (Adams Rite type)
- Faceplate #9934C28 sold separately

Wide variety of padlocks and specialty locks available – please contact to order or visit [www.viro.it](http://www.viro.it) for details

MODEL	BS	A	B	C	D	E	F	G	H
8506	$\frac{7}{8}$ (22.2)	6 (152.5)	$1\frac{3}{8}$ (34.9)	$1\frac{3}{8}$ (34.3)	$6\frac{7}{8}$ (174.9)	1 (25.2)	$1\frac{17}{32}$ (38.9)	$\frac{19}{32}$ (15.0)	1 (25.2)
8507	$\frac{31}{32}$ (24.6)	6 (152.5)	$1\frac{3}{8}$ (34.9)	$1\frac{3}{8}$ (34.3)	$6\frac{7}{8}$ (174.9)	1 (25.2)	$1\frac{5}{8}$ (41.3)	$\frac{19}{32}$ (15.0)	1 (25.2)
8508	$1\frac{1}{8}$ (28.6)	6 (152.5)	$1\frac{3}{8}$ (34.9)	$1\frac{3}{8}$ (34.3)	$6\frac{7}{8}$ (174.9)	1 (25.2)	$1\frac{23}{32}$ (45.3)	$\frac{19}{32}$ (15.0)	1 (25.2)

IN (MM)

# VIRO MORTISE LOCKS

## SECURITY HARDWARE

**VIRO** HOOKBOLT LOCK

8513, 8514

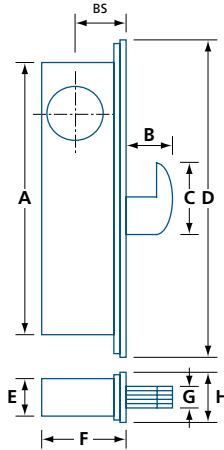

- Heavy galvanized steel construction
- Tough laminated swinging hookbolt
- $1\frac{3}{16}$ " (20.6 mm) latch throw
- Non-handed
- Cylinder backset:  $1\frac{1}{8}$ " (28.6 mm) or  $1\frac{1}{2}$ " (38.1 mm)
- Lock accepts standard  $1\frac{5}{32}$ " (29.4 mm) diameter mortise cylinder with cam A (Adams Rite type)
- Faceplate #9946C28 sold separately

Wide variety of padlocks and specialty locks available – please contact to order or visit [www.viro.it](http://www.viro.it) for details

MODEL	BS	A	B	C	D	E	F	G	H
8513	$1\frac{1}{8}$ (28.6)	6 (152.5)	$1\frac{3}{16}$ (20.6)	$1\frac{1}{4}$ (31.3)	$6\frac{7}{8}$ (174.9)	$\frac{7}{8}$ (22.0)	$1\frac{23}{32}$ (45.3)	$\frac{5}{8}$ (16.0)	1 (25.2)
8514	$1\frac{1}{2}$ (38.1)	6 (152.5)	$1\frac{3}{16}$ (20.6)	$1\frac{1}{4}$ (31.3)	$6\frac{7}{8}$ (174.9)	$\frac{7}{8}$ (22.0)	$2\frac{1}{4}$ (56.8)	$\frac{5}{8}$ (16.0)	1 (25.2)

IN (MM)

## **VIRO** FACEPLATES

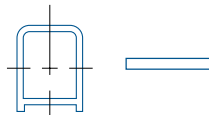

- Faceplates for VIRO deadlatch, deadbolt and hookbolt locks
- Flat anodized aluminum faceplate

MODEL	LOCK	WIDTH	LENGTH	THICKNESS	/BOX
9902C28	Deadlatch				
9934C28	Deadbolt	1 (25.4)	$6\frac{7}{8}$ (174.9)	$\frac{1}{8}$ (3.2)	20
9946C28	Hookbolt				

IN (MM)



# HANDLES & PADDLES

## SECURITY HARDWARE

### DOREX LEVER HANDLE



RIGHT HAND (RH)  
HANDLE SHOWN

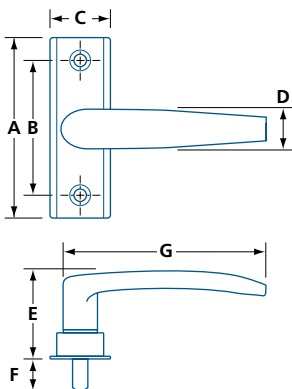

- Lever handle with cam for DL2000 series deadlatch, to be used on 1 $\frac{3}{4}$ " (44 mm) thick aluminum doors
- Left hand or right hand, field reversible
- Sturdy and dependable aluminum alloy construction
- Hardened steel spindle and cam
- 3" (76 mm) center to center mounting holes
- Cam (#0112PLUGLH / RH) included but also sold separately

#0112RH for Right Hand Reverse (RHR) or right hand (RH) doors

#0112LH for Left Hand Reverse (LHR) or left hand (LH) doors

For LH handle in Left Hand Reversed use #0112PLUGRH  
For RH handle in Right Hand Reversed use #0112PLUGLH

MODEL	HAND	FINISH	A	B	C	D	E	F	G	/CASE
0112	LH, RH	C20D, C28	4 (101.5)	3 (76.0)	1 $\frac{11}{32}$ (34.0)	$\frac{7}{8}$ (22.4)	1 $\frac{15}{16}$ (48.8)	2 $\frac{3}{32}$ (18.0)	3 $\frac{3}{4}$ (95.1)	50

IN (MM) LH: LEFT HAND, RH: RIGHT HAND

### DOREX PUSH/PULL PADDLE

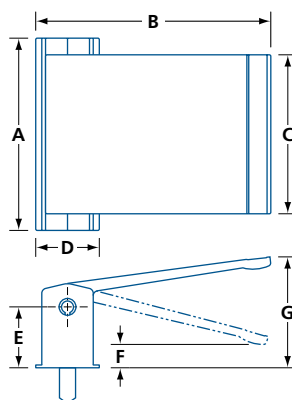
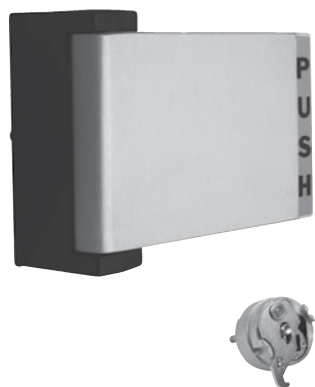

- PUSH / PULL paddle with cam for DL2000 series deadlatch
- Left hand or right hand, field reversible
- Zinc alloy base
- Extruded and anodized aluminum paddle
- 3" (76.2 mm) center to center concealed mounting holes
- Spring (#5590S) and extension kit (#5590SPK) for 2 $\frac{1}{4}$ " (57.2 mm) door thickness are available
- Cam (0112PLUGLH / RH) included but also sold separately

#5590\*R for Right Hand Reverse (RHR) or right hand (RH) outswing doors

#5590\*L for Left Hand Reverse (LHR) or left hand (LH) outswing doors

For LH handle in Left Hand Reversed use #0112PLUGRH  
For RH handle in Right Hand Reversed use #0112PLUGLH

MODEL	FINISH	HAND	A	B	C	D	E	F	G	/CASE
5590	C20D, C28	L, R	4 $\frac{1}{32}$ (102.8)	4 $\frac{15}{16}$ (125.7)	3 $\frac{11}{32}$ (85.0)	1 $\frac{11}{32}$ (34.0)	1 $\frac{5}{16}$ (33.0)	$\frac{9}{16}$ (14.0)	2 $\frac{3}{8}$ (60.0)	20

IN (MM) L: LEFT HAND, R: RIGHT HAND



# ELECTRIC STRIKES

## SECURITY HARDWARE

### UNIVERSAL ELECTRIC STRIKE

SGT78

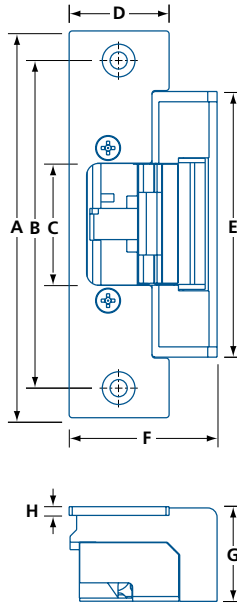

- Heavy duty (Grade 2 – 900,000 cycles)
- Low profile body fits most metal frames
- Non handed, reversible
- 12/24 AC/DC voltage (300mA@12VDC / 150mA@24VDC)
- Varistor included (surge protection)
- Static strength: 1000 lbs (454 kg)
- Dynamic strength: 50 ft-lbs (68 N-m)
- Field configurable Fail Safe (unlocked) / Fail Secure (locked)
- Includes three (3) stainless steel faceplates: ANSI Round, ANSI Square and Wood Door (see below)
- 5-year limited warranty

MODEL	FINISH	A	B	C	D	E	F	G	H
SGT78	630	47/8 (123)	41/8 (104)	117/32 (39)	11/4 (32)	33/8 (85)	17/8 (47)	17/32 (31)	1/8 (3)

IN (MM)



FP614SQ

FP604RO

FP608RO

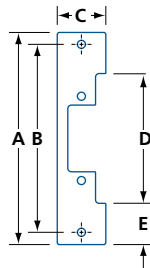

- Stainless steel face plates
- Included with #SGT78 only, not available individually
- FP604RO & FP608RO, with 5/32" (4 mm) radius

FACEPLATE TYPE		A	B	C	D	E
FP614SQ	ANSI SQUARE	47/8 (123)	41/8 (104)	11/4 (32)	33/8 (85)	3/4 (19)
FP604RO	ANSI ROUND					
FP608RO	WOOD DOOR	715/16 (203)	71/2 (189)	17/16 (37)	33/8 (85)	29/32 (58)

IN (MM)

# ELECTRIC STRIKES

## SECURITY HARDWARE

**PESO** ELECTRIC STRIKES

700, 710

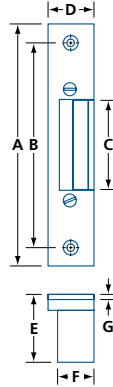

- Tough zinc alloy strike latch for wood frame application
- Reliable, mechanical and electrical components
- $\frac{5}{32}$ " (4.0 mm) horizontal adjustment after installation
- Designed for a latch projection up to  $\frac{5}{8}$ " (15.9 mm)
- Symmetrical construction, non-handed
- Faceplate finish: heavy coat of metallic silver lacquer
- Electrical mode: "Fail Secure (locked)"
- Buzz sound occurs only if AC current is used
- Duty cycle: Intermittent (60 seconds maximum)
- 2-year limited warranty (excessive force and coil burn-out not included)

MODEL	MODE	DUTY CYCLE	VOLTAGE	CURRENT	RESISTANCE	SOUND
700-16	Fail Secure (locked)	Intermittent	8-24 AC	0.36-1.09A	18 Ω	Buzz (AC only)
			8-16 DC	0.44-0.89A	18 Ω	

MODEL	A	B	C	D	E	F	G	/CASE
700	$\frac{57}{32}$ (133)	$\frac{47}{16}$ (112.6)	$\frac{115}{16}$ (49.6)	1 (25.2)	$\frac{115}{32}$ (37.7)	$\frac{13}{16}$ (20.4)	$\frac{1}{8}$ (3.2)	100

IN (MM)

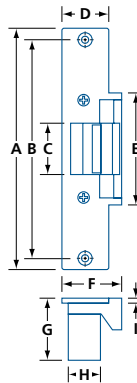

- Tough zinc alloy strike latch for metal frame application
- Reliable, well-functioning mechanical and electrical components
- $\frac{5}{32}$ " (4.0 mm) horizontal adjustment after installation
- Designed for a latch projection up to  $\frac{5}{8}$ " (15.9 mm)
- Symmetrical construction, non-handed
- Faceplate finish: heavy coat of metallic silver lacquer
- Electrical mode: "Fail Secure (locked)"
- Buzz sound occurs only if AC current is used
- Duty cycle: Intermittent (60 seconds maximum)
- 2-year limited warranty (excessive force and coil burn-out not included)

MODEL	MODE	DUTY CYCLE	VOLTAGE	CURRENT	RESISTANCE	SOUND
710-16	Fail Secure (locked)	Intermittent	16-24 AC	0.36-1.09A	40 Ω	Buzz (AC only)
			16-24 DC	0.44-0.89A	18 Ω	
710-24	Fail Secure (locked)	Intermittent	8-24 AC	0.30-0.45A	18 Ω	Buzz (AC only)
			8-16 DC	0.40-0.60A	18 Ω	

MODEL	A	B	C	D	E	F	G	H	I	/CASE
710	$\frac{529}{32}$ (149.9)	$\frac{57}{16}$ (134.7)	1¼ (31.9)	$\frac{15}{32}$ (29.1)	$\frac{223}{32}$ (69.1)	$\frac{115}{32}$ (37.2)	$\frac{117}{32}$ (38.5)	$\frac{25}{32}$ (19.9)	$\frac{1}{8}$ (3.2)	100

IN (MM)



# MORTISE CYLINDERS

## SECURITY HARDWARE

### MORTISE CYLINDERS – BRASS

MC



MC

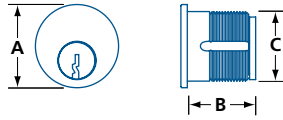

#### KEY CYLINDER

- Solid brass cylinder with 5 or 6 pins
- Drilled for Construction Master Key (CMK)
- Adams Rite type (A) cam included
- Trim ring NOT included; sold separately (#COL6-26D)
- Keyways: Schlage (SC), Yale (YA) or Weiser (WR)
- Includes 2 keys
- Cam type B available; sold separately (#MC-CAMB)

MC	118	A	-	SC	KD6	-	26D
MODEL	LENGTH	CAM	KEY	KEYING	FINISH		

MODEL	LENGTH	∅A	B	∅C	CAM	KEYWAY	KEYING	PINS	FINISH	/CASE
MC	100	1 <sup>3</sup> / <sub>8</sub> (35)	1 (25.4)	1 <sup>5</sup> / <sub>32</sub> (29.1)	A	SC, YA, WR	KD, KAX2	5	26D	100
MC	118	1 <sup>3</sup> / <sub>8</sub> (35)	1 <sup>1</sup> / <sub>8</sub> (29)	1 <sup>5</sup> / <sub>32</sub> (29.1)	A	SC, YA, WR	KD6	6	26D, 10B	100
MC	114	1 <sup>3</sup> / <sub>8</sub> (35)	1 <sup>1</sup> / <sub>4</sub> (32)	1 <sup>5</sup> / <sub>32</sub> (29.1)	A	SC, YA	KD6	6	26D	100

IN (MM) (\*) FULL KEYING SERVICES AVAILABLE. KAX2: KEYED ALIKE, PAIRED CYLINDERS, 50 PAIRS PER CASE  
 KD: KEYED DIFFERENT, 5 PIN, DRILLED 6  
 KD6: KEYED DIFFERENT, 6PINS



M-D

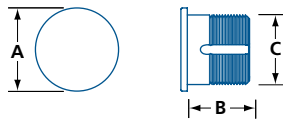

#### DUMMY CYLINDER

- Solid brass construction (not hollow)
- Trim ring NOT included; sold separately (#COL6-26D)

M	100	-	D	-	20D
MODEL	LENGTH	TYPE	FINISH		



M-T

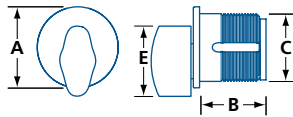

#### THUMB-TURN CYLINDERS

- Solid brass construction
- Ergonomic ADA thumb-turn for easy turning (TA)
- Regular thumb-turn available (T)
- Adams Rite type (A) cam included
- Trim ring NOT included; sold separately (#COL6-26D)
- Cam type B available; sold separately (#MC-CAMB)



M-TA

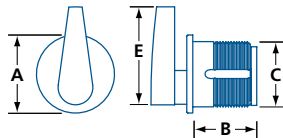

M	118	A	-	TA	-	26D
MODEL	LENGTH	CAM	TYPE	FINISH		

MODEL	LENGTH	∅A	B	∅C	E	CAM	TYPE	FINISH	/CASE
M	100	1 <sup>3</sup> / <sub>8</sub> (35)	1 (25.4)	1 <sup>5</sup> / <sub>32</sub> (29.1)	—	—	D, T, TA	26D, 10B	100
M	118	1 <sup>3</sup> / <sub>8</sub> (35)	1 <sup>1</sup> / <sub>8</sub> (29)	1 <sup>5</sup> / <sub>32</sub> (29.1)	1 (25.4)	A	TA	26D	100
M	114	1 <sup>3</sup> / <sub>8</sub> (35)	1 <sup>1</sup> / <sub>4</sub> (32)	1 <sup>5</sup> / <sub>32</sub> (29.1)	1 <sup>3</sup> / <sub>4</sub> (44.5)	A	TA	26D	100

IN (MM)

# MORTISE CYLINDERS

## SECURITY HARDWARE

### MORTISE CYLINDERS – BRASS

CBM

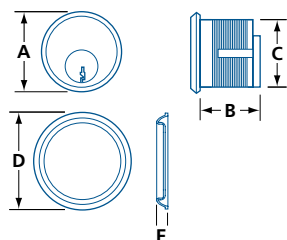

#### KEY CYLINDER

- Solid brass construction with aluminum clad face
- 5-pin, or 5-pin drilled for 6-pin
- Trim ring included
- Keyways: Schlage (SC), Yale #9 (Y9) or Weiser (WR)
- Includes 2 keys
- Cams: Adams Rite type (cam A) or Yale type (cam B)

CBM	118	A	-	SC	KD	-	28
MODEL	LENGTH	CAM	KEY	KEYING	FINISH		

MODEL	LENGTH	∅A	B	∅C	D	E	CAM	KEYWAY	KEYING	PINS	FINISH	/CASE
CBM	034	1 <sup>3</sup> / <sub>8</sub> (35)	3/4 (19)	1 <sup>5</sup> / <sub>32</sub> (29.1)	1 <sup>9</sup> / <sub>16</sub> (40)	7/32 (5.7)	A, B	SC, Y9, WR	KA, KA2, KD	5	20D, 26D, 28	100
CBM	100	1 <sup>3</sup> / <sub>8</sub> (35)	1 (25.4)	1 <sup>5</sup> / <sub>32</sub> (29.1)	1 <sup>9</sup> / <sub>16</sub> (40)	7/32 (5.7)	A, B	SC, Y9, WR	KA, KA2, KD	5	20D, 26D, 28	100
CBM	118	1 <sup>3</sup> / <sub>8</sub> (35)	1 <sup>1</sup> / <sub>8</sub> (29)	1 <sup>5</sup> / <sub>32</sub> (29.1)	1 <sup>9</sup> / <sub>16</sub> (40)	7/32 (5.7)	A, B	SC, Y9, WR	KA, KA2, KD	5*	20D, 26D, 28	100
CBM	114	1 <sup>3</sup> / <sub>8</sub> (35)	1 <sup>1</sup> / <sub>4</sub> (32)	1 <sup>5</sup> / <sub>32</sub> (29.1)	1 <sup>9</sup> / <sub>16</sub> (40)	7/32 (5.7)	A, B	SC, Y9, WR	KA, KA2, KD	5*	20D, 26D, 28	100

IN (MM) (\*) 5-PIN CYLINDER, DRILLED 6

KA: KEYED ALIKE KA2: KEYED ALIKE, PAIRED CYLINDERS, 50 PAIRS PER CASE  
KD: KEYED DIFFERENT

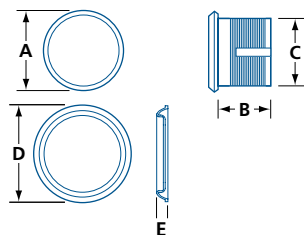

#### DUMMY CYLINDER

- Solid brass construction with aluminum clad face
- Trim ring included

CBM	100	-	DM	-	28
MODEL	LENGTH	TYPE	FINISH		

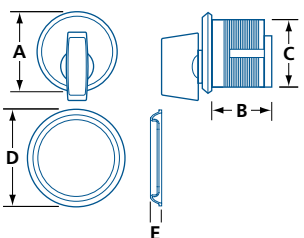

#### THUMB-TURN CYLINDER

- Solid brass construction with aluminum clad face
- Trim ring included
- Cams: Adams Rite type (cam A) or Yale type (cam B)

CBM	100	A	-	T1	-	28
MODEL	LENGTH	CAM	TYPE	FINISH		

MODEL	LENGTH	∅A	B	∅C	D	E	CAM*	TYPE	FINISH	/CASE
CBM	100	1 <sup>3</sup> / <sub>8</sub> (35)	1 (25.4)	1 <sup>5</sup> / <sub>32</sub> (29.1)	1 <sup>9</sup> / <sub>16</sub> (40)	7/32 (5.7)	A, B	DM, T1	20D, 28	100

IN (MM) (\*) LEAVE BLANK WHEN ORDERING DUMMY CYLINDER



# MORTISE CYLINDERS

## SECURITY HARDWARE

### MORTISE CYLINDERS – ZINC

CZM

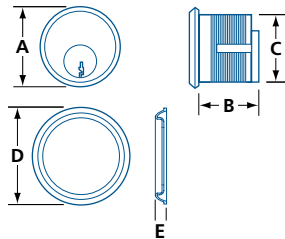

#### KEY CYLINDER

- Solid zinc construction with aluminum clad face
- 5-pin cylinder
- Trim ring included
- Keyways: Schlage (SC), Yale #9 (Y9) or Weiser (WR)
- Includes 2 keys
- Cams: Adams Rite type (cam A) or Yale type (cam B)

CZM	100	A	-	SC	KD	-	28
MODEL	LENGTH	CAM	KEY	KEYING	FINISH		

MODEL	LENGTH	∅A	B	∅C	D	E	CAM	KEYWAY	KEYING	PINS	FINISH	/CASE
CZM	100	1 3/8 (35)	1 (25.4)	1 5/32 (29.1)	1 9/16 (40)	7/32 (5.7)	A, B	SC, Y9, WR	KA, KA2, KD	5	1B, 26D, 28	100

IN (MM)    KA: KEYED ALIKE    KA2: KEYED ALIKE, PAIRED CYLINDERS, 50 PAIRS PER CASE    KD: KEYED DIFFERENT

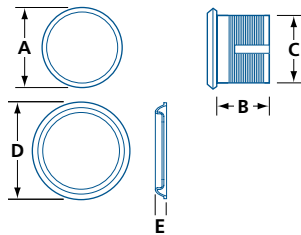

#### DUMMY CYLINDER

- Solid zinc construction with aluminum clad face
- Trim ring included

CZM	100	-	DM	-	28
MODEL	LENGTH	TYPE	FINISH		

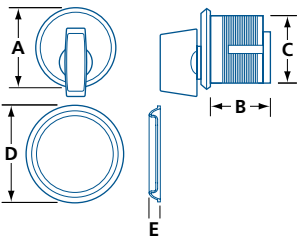

#### THUMB-TURN CYLINDER

- Solid zinc construction with aluminum clad face
- Trim ring included
- Cams: Adams Rite type (cam A) or Yale type (cam B)

CZM	100	A	-	T1	-	28
MODEL	LENGTH	CAM	TYPE	FINISH		

MODEL	LENGTH	∅A	B	∅C	D	E	CAM*	TYPE	FINISH	/CASE
CZM-DM	100	1 3/8 (35)	7/8 (22.8)	1 5/32 (29.1)	1 9/16 (40)	7/32 (5.7)	A, B	DM, T1	1B, 28	100
CZM-T1	100	1 3/8 (35)	1 (25.4)	1 5/32 (29.1)	1 9/16 (40)	7/32 (5.7)	A, B	DM, T1	1B, 28	100

IN (MM)    (\*) LEAVE BLANK WHEN ORDERING DUMMY CYLINDER

# MORTISE CYLINDERS

## SECURITY HARDWARE

**Viro** MORTISE CYLINDERS



731731

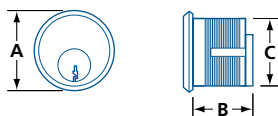

732

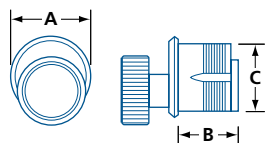

- Solid brass cylinder and trim ring
- 5-pin Viro #015 keyway
- Supplied with 3 nickel-plated brass keys per pair of cylinders
- Supplied with cam A; cam B (#CAM991) available separately
- Packaged and sold in pairs
- Keyed alike in pairs
- Key blank: #303KB015RH

Wide variety of padlocks and specialty locks available – please contact to order or visit [www.viro.it](http://www.viro.it) for details

MODEL	∅A	B	∅C
731731	1¼	1	1½ <sub>32</sub>
732	(31.8)	(25.3)	(29.1)

IN (MM)

MODEL	FINISH	MATERIAL	LENGTH	CAM	KEYWAY	KEYING	/UNIT	/BOX
731731	C3, C15	Brass	1 (25.3)	A	Viro #015	KA2	2	6*
732	C15	Brass	1 (25.3)	A	—	—	1	6

(\*) 3 PAIRS



# RIM CYLINDERS

## SECURITY HARDWARE

### RIM CYLINDER

MR

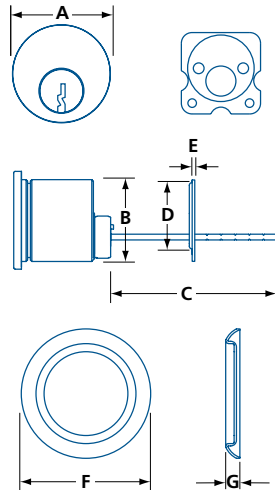

- Solid brass cylinder, trim ring included
- Cylinder length: 118 = 1 1/8" (28.6 mm)
- 6-pin, drilled for Construction Master Key (CMK)
- Keyways: Schlage (SC) or Weiser (WR)
- 2 keys included
- Tailpiece converts between horizontal and vertical positions
- Screw-on retaining cap

MR	118	- WR	KD6	-	26D
MODEL	LENGTH	KEY	KEYING		FINISH

MODEL	øA	øB	C	D	E	F	G
MR	1 3/8 (34.5)	1 5/32 (29.1)	2 7/16 (60)	1 13/64 (31)	3/16 (1.2)	1 13/16 (45.8)	3/16 (5)

IN (MM)

MODEL	LENGTH	CAM	KEYWAY	KEYING*	PINS	FINISH	/CASE
MR	118	—	SC, WR	KD6	6	19, 26D	100

(\*) FULL KEYING SERVICES AVAILABLE – PLEASE CONTACT

KD: KEYED DIFFERENT

### RIM CYLINDER

CBR

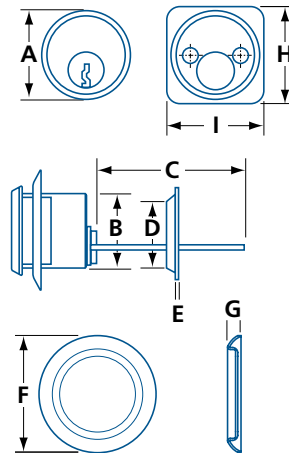

- Solid brass with aluminum clad face, trim ring included
- Cylinder length: 114 = 1 1/4" (32 mm)
- Keyways: 6-pin Schlage (SC) or special order 5-pin Yale #9 (Y9)
- 2 keys included
- Standard tailpiece and mounting hardware

CBR	114	- Y9	KD	-	26D
MODEL	LENGTH	KEY	KEYING		FINISH

MODEL	øA	øB	C	D	E	F	G	H	I
CBR	1 3/8 (34.5)	1 5/32 (29.1)	2 7/16 (62)	1 5/32 (29.4)	1/16 (1.6)	1 9/16 (40)	7/32 (5.7)	1 5/16 (33)	1 5/16 (33)

IN (MM)

MODEL	LENGTH	CAM	KEYWAY	KEYING	PINS	FINISH	/CASE
CBR	114	—	SC, Y9*	KD	6	19, 26D	100

(\*) SPECIAL ORDER

KD: KEYED DIFFERENT

# RIM CYLINDERS

## SECURITY HARDWARE

### DUMMY RIM CYLINDER

160

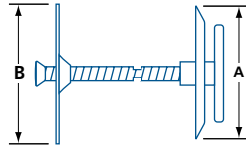

- Solid brass construction
- Covers cylinder hole in doors up to 2¼" (57.2 mm) thick
- Supplied with mounting backplate and 2" (50.8 mm) long break away screw
- Available in brass plated (BP) or satin chrome (C26D) finishes

MODEL	FINISH	øA	øB	/CASE
160	BP, C26D	1 <sup>13</sup> / <sub>16</sub> (46)	1 <sup>7</sup> / <sub>8</sub> (48)	300

IN (MM)



# CYLINDER TRIM RINGS

SECURITY HARDWARE

## CYLINDER TRIM RINGS & GUARDS

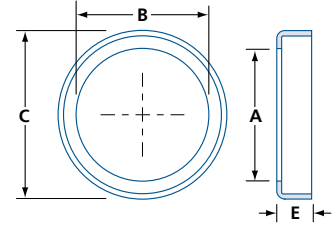
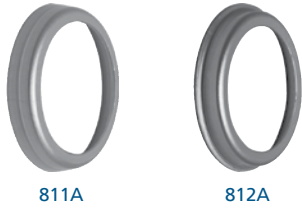

MODEL	FINISH	MATERIAL	∅A	∅B	∅C	D	E	/BOX
811A	C26D, C28	Aluminum	1 <sup>13</sup> / <sub>32</sub> (36.0)	1 <sup>5</sup> / <sub>32</sub> (29.3)	1 <sup>1</sup> / <sub>2</sub> (38.0)	7/ <sub>32</sub> (5.5)	—	100
812A	C26D, C28	Aluminum	1 <sup>13</sup> / <sub>32</sub> (36.0)	1 <sup>5</sup> / <sub>32</sub> (29.3)	1 <sup>9</sup> / <sub>16</sub> (39.6)	7/ <sub>32</sub> (5.5)	—	100

IN (MM)

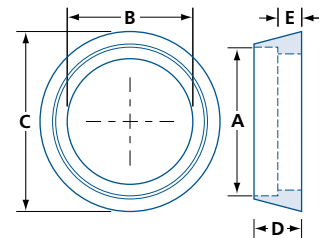
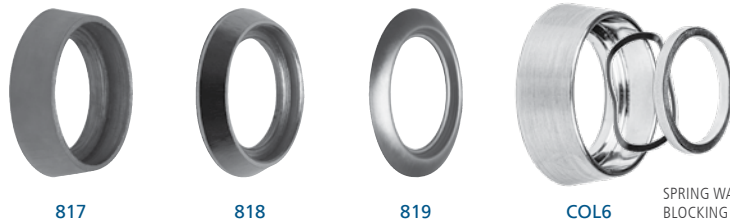

MODEL	FINISH	MATERIAL	∅A	∅B	∅C	D	E	/BOX
817S	C26D	Hardened steel	1 <sup>13</sup> / <sub>32</sub> (36.0)	1 <sup>3</sup> / <sub>16</sub> (30.0)	1 <sup>11</sup> / <sub>16</sub> (42.9)	7/ <sub>16</sub> (11.4)	5/ <sub>32</sub> (4.0)	50
818S	C28, C26D	Hardened steel	1 <sup>1</sup> / <sub>2</sub> (37.8)	1 <sup>3</sup> / <sub>16</sub> (30.0)	1 <sup>11</sup> / <sub>16</sub> (42.9)	9/ <sub>32</sub> (7.3)	3/ <sub>16</sub> (4.4)	50
819A	C28	Aluminum	1 <sup>11</sup> / <sub>32</sub> (34.0)	1 <sup>7</sup> / <sub>32</sub> (31)	1 <sup>7</sup> / <sub>8</sub> (47.6)	1/ <sub>8</sub> (3.75)	3/ <sub>32</sub> (2.0)	100
COL6	C26D, C19	Hardened steel	1 <sup>13</sup> / <sub>32</sub> (36.0)	1 <sup>3</sup> / <sub>16</sub> (30.0)	1 <sup>7</sup> / <sub>16</sub> (36.6)	9/ <sub>16</sub> (14.3)	3/ <sub>16</sub> * (4.5*)	100

IN (MM) (\*) 3/<sub>16</sub>" (7.5MM) WITH INCLUDED 1/<sub>8</sub>" (3MM) BLOCKING RING.

## ADJUSTABLE CYLINDER TRIM RING

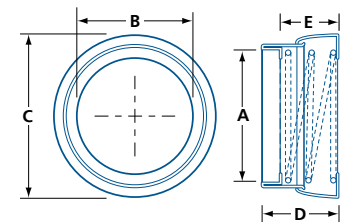

MODEL	FINISH	MATERIAL	∅A	∅B	∅C	D	E	/BOX
814S	C26D, C28	Steel	1 <sup>3</sup> / <sub>8</sub> (35.0)	1 <sup>3</sup> / <sub>16</sub> (30.0)	2 (50.8)	9/ <sub>16</sub> -7/ <sub>8</sub> (14.3-22.2)	27/ <sub>64</sub> -47/ <sub>64</sub> (10.7-18.6)	250

IN (MM)

# CYLINDER TRIM RINGS

## SECURITY HARDWARE

### BLOCKING RING

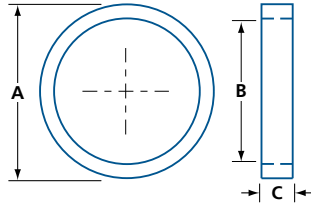

- Solid aluminum blocking ring for 1 $\frac{5}{32}$ " (29 mm) mortise cylinder

MODEL	MATERIAL	$\varnothing A$	$\varnothing B$	C	/BOX
815AC28	Aluminum	1 $\frac{3}{8}$ (35)	1 $\frac{5}{32}$ (29)	$\frac{1}{4}$ (6.4)	100

IN (MM)

### SPRING WASHER

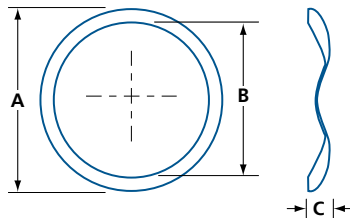

- Stainless steel spring washer for 1 $\frac{5}{32}$ " (29 mm) mortise cylinder

MODEL	MATERIAL	$\varnothing A$	$\varnothing B$	C	/BOX
820S	Stainless steel	1 $\frac{3}{8}$ (35)	1 $\frac{5}{32}$ (29)	$\frac{5}{32}$ (4.1)	500

IN (MM)

### MORTISE CYLINDER RING NUT

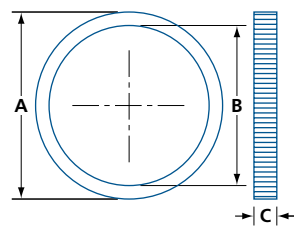

- Solid brass threaded locking ring nut for 1 $\frac{5}{32}$ " (29 mm) mortise cylinder

MODEL	MATERIAL	$\varnothing A$	$\varnothing B$	C	/BOX
2315-2	Brass	1 $\frac{5}{16}$ (33.5)	1 $\frac{1}{8}$ (28.6)	$\frac{5}{32}$ (4.1)	100

IN (MM)



# GUARDS & LATCH PROTECTORS

SECURITY HARDWARE

## CYLINDER GUARD

5510

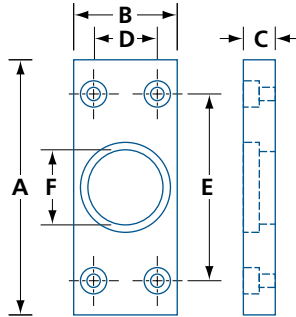

- Heavy aluminum plate
- Mounts to metal door with 4 steel  $\frac{3}{16}$ " (4.8 mm) pop rivets (included)
- $\frac{1}{4}$ " (6.4 mm) cylinder recess

MODEL	FINISH	A	B	C	D	E	∅F	/BOX
5510	Aluminum	4 (102)	1 $\frac{5}{8}$ (41.4)	$\frac{1}{2}$ (12.8)	1 (25.5)	3 (76)	1 $\frac{3}{16}$ (30.1)	20

IN (MM)

## CYLINDER / LATCH GUARD

LPA

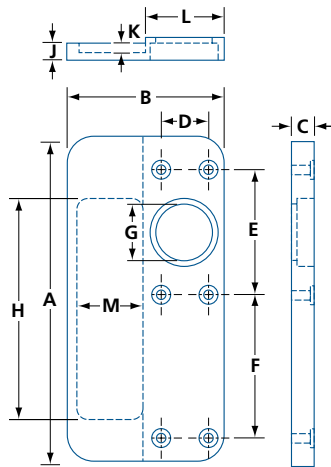

- Solid 6061 aluminum plate
- Handed
- Mounts to metal door with 6 steel  $\frac{3}{16}$ " (4.8 mm) pop rivets (included)
- For use on narrow style aluminum doors
- Protects latch, cylinder and strike
- $1\frac{1}{32}$ " (8.7 mm) cylinder recess
- Cylinder spacers included
- Available in matte black #LPB45F

LPA45C for flush doors

LPA45D for offset doors

LPA45F for offset doors with wide electric strike

MODEL	A	B	C	D	E	F	∅G	H	J	K	L	M
LPA45C	6 $\frac{3}{4}$ (171)	3 $\frac{1}{4}$ (82.5)	$\frac{1}{2}$ (12.7)	1 (25.4)	2 $\frac{19}{32}$ (66)	3 (76)	1 $\frac{3}{16}$ (30)	—	—	—	—	—
LPA45D	6 $\frac{3}{4}$ (171)	3 $\frac{1}{4}$ (82.5)	$\frac{1}{2}$ (12.7)	1 (25.4)	2 $\frac{19}{32}$ (66)	3 (76)	1 $\frac{3}{16}$ (30)	—	$\frac{3}{8}$ (9.5)	—	1 $\frac{5}{8}$ (41)	—
LPA45F	6 $\frac{3}{4}$ (171)	3 $\frac{1}{4}$ (82.5)	$\frac{1}{2}$ (12.7)	1 (25.4)	2 $\frac{19}{32}$ (66)	3 (76)	1 $\frac{3}{16}$ (30)	4 $\frac{3}{4}$ (120)	$\frac{3}{8}$ (9.5)	$\frac{9}{32}$ (7.1)	1 $\frac{5}{8}$ (41)	1 $\frac{1}{2}$ (38.1)

IN (MM)

# GUARDS & LATCH PROTECTORS

## SECURITY HARDWARE

### LATCH PROTECTORS



- Unit covers the latch area of the door, thereby providing added protection from burglaries, vandalism or abuse
- For use with maximum 2½" (63.5 mm) diameter mortise or 3¾" (92.1 mm) cylindrical lock
- Made of heavy gauge steel
- 311P and 311LP are supplied with security pin to prevent separation of the door and frame
- Individually packed and supplied with carriage bolts and nuts

**#311BOLTKIT** Bolt kit for exterior doors with weatherstripping

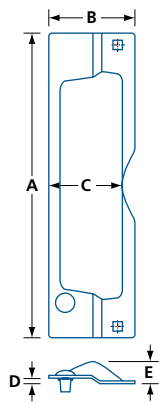

MODEL	FINISH	A	B	C	D	E	/CASE
307	C28	7	3	—	9/32 (7)	3/4 (19)	40
307L		(177.7)	(76.3)	2 9/16 (65.0)			
311P	C28	10 7/8 (276.5)	3 3/32 (78.2)	—	9/32 (7)	3/4 (19)	40
311S				2 7/8 (73.0)			
311LP				2 5/8 (67.0)			

IN (MM)



# PROFILE CYLINDERS

## SECURITY HARDWARE

### Viro DOUBLE CYLINDER

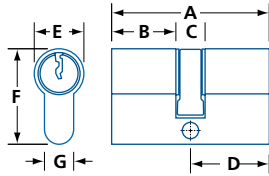

- Solid extruded tear-drop profile cylinder for sliding door mortise locks
- 5-pin Viro #062 keyway
- 3 keys and 3" (76mm) fastening screw included
- Escutcheon plate #721 sold separately; 2 required per cylinder

Wide variety of padlocks and specialty locks available – please contact to order or visit [www.viro.it](http://www.viro.it) for details



**721BP** Brass Plated  
**721NP** Nickel Plated

- Supplied with mounting screws



**KB062** Nickel Plated  
Keyblank

9203	KD	C15
MODEL	KEYING	FINISH

MODEL	NO.OF PINS	KEYWAY	KEYING	FINISH	A	B	C	D	E	F	G	/BOX
9203	5	Viro #062	KD	C3, C15	2 <sup>3</sup> / <sub>8</sub> (60)	1 (25)	1 <sup>9</sup> / <sub>32</sub> (10.1)	1 <sup>3</sup> / <sub>16</sub> (30)	2 <sup>1</sup> / <sub>32</sub> (17)	1 <sup>5</sup> / <sub>16</sub> (33)	3 <sup>8</sup> / <sub>16</sub> (10)	10
92015	5	Viro #062	KD	C3	2 <sup>3</sup> / <sub>4</sub> (70)	1 <sup>3</sup> / <sub>16</sub> (30)	1 <sup>9</sup> / <sub>32</sub> (10.1)	1 <sup>3</sup> / <sub>8</sub> (35)	2 <sup>1</sup> / <sub>32</sub> (17)	1 <sup>5</sup> / <sub>16</sub> (33)	3 <sup>8</sup> / <sub>16</sub> (10)	10
921	5	Viro #062	KD	C3, C15	2 <sup>1</sup> / <sub>8</sub> (54)	7 <sup>8</sup> / <sub>16</sub> (22.2)	3 <sup>8</sup> / <sub>16</sub> (9.5)	1 <sup>1</sup> / <sub>16</sub> (27)	2 <sup>1</sup> / <sub>32</sub> (17)	1 <sup>5</sup> / <sub>16</sub> (33)	3 <sup>8</sup> / <sub>16</sub> (10)	10

IN (MM)

### Viro THUMBTURN CYLINDER

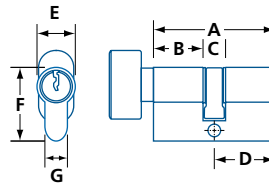

- Solid extruded tear-drop profile cylinder for sliding door mortise locks
- Brass knob, removable, easy to grip, with rounded edges
- 5-pin Viro #015 keyway
- 3 keys and fastening screw included
- Escutcheon plate #721 sold separately; 2 required per cylinder
- Viro keyblank #303KB available

Wide variety of padlocks and specialty locks available – please contact to order or visit [www.viro.it](http://www.viro.it) for details



**721BP** Brass Plated  
**721NP** Nickel Plated

- Supplied with mounting screws



**303KB** Nickel Plated  
Keyblank

7407	KD	C15
MODEL	KEYING	FINISH

MODEL	NO.OF PINS	KEYWAY	KEYING	FINISH	A	B	C	D	E	F	G	/BOX
7407	5	Viro #015	KD	C3, C15	2 <sup>3</sup> / <sub>4</sub> (70)	1 <sup>3</sup> / <sub>16</sub> (30)	1 <sup>9</sup> / <sub>32</sub> (10.1)	1 <sup>3</sup> / <sub>8</sub> (35)	2 <sup>1</sup> / <sub>32</sub> (17)	1 <sup>5</sup> / <sub>16</sub> (33)	3 <sup>8</sup> / <sub>16</sub> (10)	10

IN (MM)



# DOOR VIEWERS

## SECURITY HARDWARE

### DOOR VIEWERS



B02

- Solid brass door viewer
- Acrylic optical lens
- Individually boxed

MODEL	FINISH	DOOR THICKNESS	ø BORE	FIRE RATING	VISION ANGLE	/BOX
B02	C26D		12mm	—	160°	25
B03	C3, C26D	1 <sup>3</sup> / <sub>8</sub> –2 <sup>1</sup> / <sub>4</sub> (35–57)	14mm	—	180°	25
B04	C3, C26D		16mm	—	200°	10

IN (MM)



DV160



DV180, DV200

- Solid brass door viewer
- cULus 20 minute fire rating for labelled fire doors
- Polished glass and acrylic optical lenses
- Individually boxed

MODEL	FINISH	DOOR THICKNESS	ø BORE	FIRE RATING	VISION ANGLE	/BOX
DV160	26, 26D	1 <sup>3</sup> / <sub>8</sub> –2 (35–51)	12mm	20 min	160°	25
DV180	26D, 19		14mm	20 min	180°	25
DV200	26D	1 <sup>3</sup> / <sub>8</sub> –2 <sup>1</sup> / <sub>4</sub> (35–57)	14mm	20 min	200°	10

IN (MM)



DV1012SRG



DV1012BRQ



DV1012BLQ

- Solid brass door viewer
- cULus 90 minute fire rating for labelled fire doors
- Polished glass and quartz lens
- Individually boxed

MODEL	FINISH	DOOR THICKNESS	ø BORE	FIRE RATING	VISION ANGLE	/BOX
DV1012SRG	15, 19, 26D	1 <sup>1</sup> / <sub>16</sub> –1 <sup>1</sup> / <sub>16</sub> (17.5–27)	12mm	90min	160°	25
DV1012BRQ	26	1 <sup>3</sup> / <sub>8</sub> –2 (35–51)	12mm	90min	160°	42
DV1012BLQ	19, 26		12mm	90min	200°	25
DV1014BLQ	C15, C19, C26, 26D	1 <sup>3</sup> / <sub>4</sub> –2 <sup>1</sup> / <sub>4</sub> (44.5–57)	14mm	90min	200°	25

IN (MM)

# DOOR VIEWERS

## SECURITY HARDWARE

### REVOLVING DOOR VIEWER

511

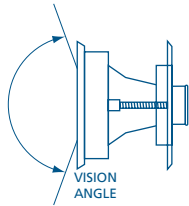
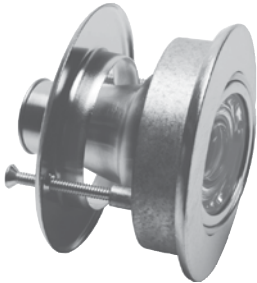

- Revolving door viewer
- Stamped brass components
- Crystal optical glass lenses
- Individually boxed
- 511 KTD Extension kit available for 1½ to 2" (38 to 50.3 mm) thick doors

MODEL	FINISH	DOOR THICKNESS	Ø BORE	FIRE RATING	VISION ANGLE	/UNIT
511	C3, C26D, C19	1¾ – 1¾ * (35–44)	2¾ (60.3)	—	140°	1

IN (MM) \*1½ TO 2" (38 TO 50.3 MM) WITH EXTENSION KIT

### REFLEX DOOR VIEWER

DS1000, DS2000

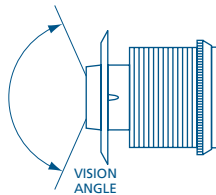

- Reflex door viewer with 2" (50.3 mm) screen
- Warnock Hersey listed for 20 minutes fire rated location when used with firestop sealant (not supplied) on a wood composite fire door
- Precision optics, no image distortion, clear viewing up to 7 feet away
- Individually carded

MODEL	FINISH	MATERIAL	DOOR THICKNESS	Ø BORE	FIRE RATING	VISION ANGLE	/UNIT
DS1000	BL, BR, GR	ABS plastic	1¾–2 (35–51)	2¾ (60.3)	20 min	132°	1
DS2000	SL, BL	Aluminum					

IN (MM)

### DOOR VIEWER – LARGE

DS300



DS300CHR-COVER

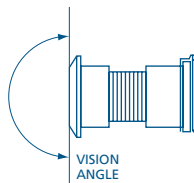

- Zinc die cast door viewer
- Polished glass optical lens
- Viewer is intended for use with classified fire door rated up to and including 90 minutes
- Detachable lens cover is included
- Individually boxed
- Replacement lens cover: #DS300CHR-COVER

MODEL	FINISH	DOOR THICKNESS	Ø BORE	FIRE RATING	VISION ANGLE	/BOX
DS300	BP, CHR	1¾–2 (35–51)	31/32 (24.5)	90 min	180°	15

IN (MM)



# DOOR GUARDS & CHAINS

SECURITY HARDWARE

## PRIVACY DOOR GUARD

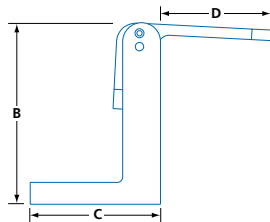
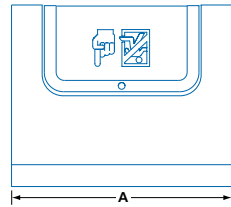

- Listed for use on fire rated openings (3 hrs)
- ADA Compliant
- Zinc die-cast body and latch
- Allows door to open 4°
- Silicone pads protect door and reduce noise
- Easy to install and operate
- Includes sheet-metal screws, machine screws and rivet nuts
- Rivet nut tool not included
- Non-listed model available (#PDG)

MODEL	FINISH	A	B	C	D	/BOX
PDGF	19, 15,	2 <sup>5</sup> / <sub>8</sub>	2 <sup>5</sup> / <sub>32</sub>	1 <sup>9</sup> / <sub>16</sub>	1 <sup>5</sup> / <sub>16</sub>	10
PDG	26D	(66.6)	(54.7)	(39)	(33)	

IN (MM)

## DOOR GUARD

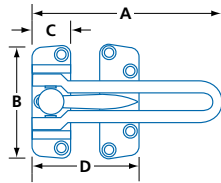
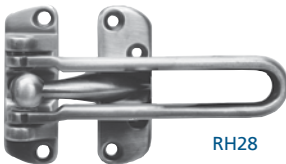

- High security zinc alloy door guard, supplied with mounting screws
- RH28 finish: antique brass, antique bronze, antique nickel, polished brass, polished chrome, satin chrome or satin nickel
- Protective edge plates for door guard RH28EP, 9/16 x 1 x 1 3/16" (14.3 x 25.4 x 30 mm) sold separately
- Finish: RH28EP: aluminum(C28), polished brass (C3)  
AP34: satin chrome (626)



MODEL	FINISH	A	B	C	D	/BOX
RH28	AB, AN, BP, C11P, CHR, SC, SN	4 <sup>1</sup> / <sub>4</sub> (108)	2 <sup>7</sup> / <sub>16</sub> (62)	1 <sup>3</sup> / <sub>16</sub> (21)	2 <sup>5</sup> / <sub>8</sub> (67)	10

IN (MM)

## DOOR CHAIN

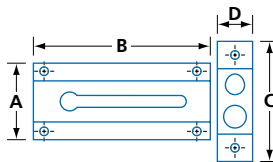
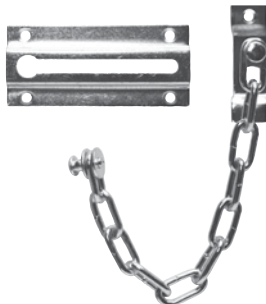

- Economical model plated steel chain guard with welded steel chain in poly bag
- Supplied with mounting screws
- Nickel plated (NP) finish

MODEL	CHAIN	A	B	C	D	/BOX
232.620NP	8 (203)	1 <sup>7</sup> / <sub>16</sub> (36)	3 <sup>3</sup> / <sub>8</sub> (86.0)	2 <sup>5</sup> / <sub>16</sub> (58)	1 <sup>1</sup> / <sub>16</sub> (17.1)	10

IN (MM)



# RIM LOCKS

## SECURITY HARDWARE

### NIGHT LATCH

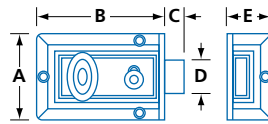
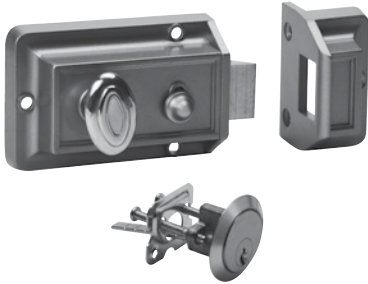

- Zinc alloy case and strike
- Solid brass bolt and deadlatch button
- Solid brass 5-pin Yale #9 keyway rim cylinder and trim ring included
- $\frac{9}{16}$ " (14.4 mm) latch throw
- Cylinder screws for up to  $2\frac{1}{4}$ " (57 mm) door thickness
- Supplied with mounting screws
- Finish: painted gold color

MODEL	A	B	C	D	E	/BOX
0508-1	$2\frac{1}{2}$ (63)	$3\frac{5}{8}$ (91.9)	$\frac{9}{16}$ (14.4)	$\frac{15}{16}$ (24.1)	$1\frac{1}{4}$ (31.9)	12

IN (MM)

### JIMMY PROOF DEADLOCK

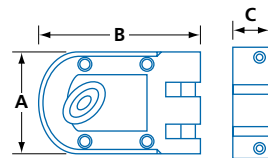
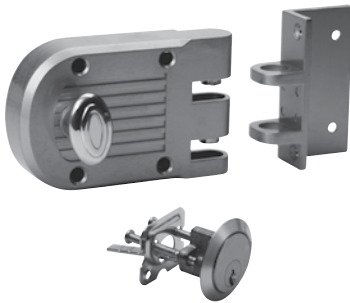

- Zinc alloy case and keeper
- Brass plated reinforced steel vertical bolts
- Solid brass 5-pin Yale #9 keyway rim cylinder and trim ring included
- Available keyed alike (KA) or keyed different (KD)
- Cylinder screws for up to  $2\frac{1}{4}$ " (57 mm) door thickness
- Supplied with mounting screws
- Finish: painted gold color

MODEL	A	B	C	/BOX
0515-1	$2\frac{25}{32}$ (70.5)	$4\frac{13}{32}$ (112.0)	1 (25.5)	12

IN (MM)

### JIMMY PROOF DEADLOCK – DOUBLE CYLINDER

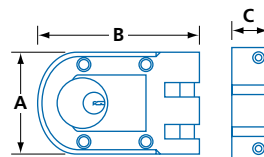
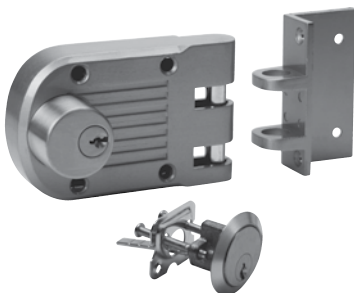

- Zinc alloy case and keeper
- Brass plated reinforced steel vertical bolts
- 2 solid brass 5-pin Yale #9 keyway rim cylinders and trim rings included
- Cylinder screws for up to  $2\frac{1}{4}$ " (57 mm) door thickness
- Supplied with mounting screws
- Finish: painted gold color

MODEL	A	B	C	/BOX
0515A-1	$2\frac{25}{32}$ (70.5)	$4\frac{13}{32}$ (112.0)	1 (25.5)	12

IN (MM)



# DOOR PROTECTION

## SECURITY HARDWARE

### WRAP AROUND PLATES

WP4B, WP9B, WDC12B, WDCP12B



WP9



WDC12



WDCP12

- For cylindrical locks with 2 1/8" (54mm) bore hole
- For 1 3/4" (45mm) door thickness
- 22 gauge stainless steel
- Latch faceplate recess fits:  
1 1/8 x 2 1/4" (28.5 x 57mm) latches
- Mounting screws included

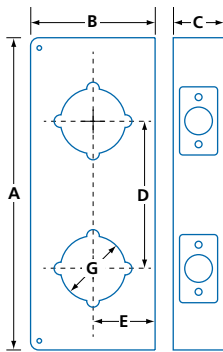

MODEL	A	B	C	D	E	∅G
WP4BA-32D	4 1/2 (114.5)	4 (102)	1 3/4 (45)	—	2 3/8 (60)	2 1/8 (54)
WP4BB-32D		4 1/4 (108)			2 3/4 (70)	
WP9BA-32D	9 (229)	4 (102)	1 3/4 (45)	—	2 3/8 (60)	2 1/8 (54)
WP9BB-32D		4 1/4 (108)			2 3/4 (70)	
WDC12BA-32D	12 (305)	4 (102)	1 3/4 (45)	5 1/2 (140)	2 3/8 (60)	2 1/8 (54)
WDC12BB-32D		4 1/4 (108)			2 3/4 (70)	
WDCP12BA-32D	12 (305)	4 (102)	1 3/4 (45)	5 1/2 (140)	2 3/8 (60)	2 1/8 (54)
WDCP12BB-32D		4 1/4 (108)			2 3/4 (70)	

IN (MM)



# CAM LOCKS

## SECURITY HARDWARE

### Viro SOLID BRASS CAM LOCK

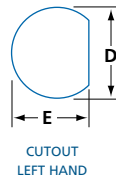
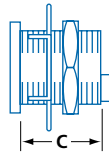
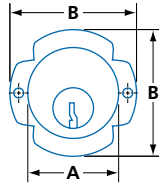

- Solid brass, fully threaded, pin tumbler cylinder
- Handed models supplied RH, LH available on special order
- Milled on one side to prevent rotation (single "D")
- 1012 and 1013 come with center plug position
- Universal use, easy to install on wood or metal cabinet and mailbox
- Supplied with 4 prong steel washer, securing nut, cam screw and 2 keys
- Custom keyed systems available
- Supplied with cam, please specify cam model
- Finish: natural brass (C3) or nickel plated (C15)

1053	KD	C15
MODEL	KEYING	FINISH

Wide variety of padlocks and specialty locks available – please contact to order or visit [www.viro.it](http://www.viro.it) for details



**301KB** for 1012 & 1052 cam locks  
**302KB** for 1003, 1004, 1005, 1013, 1053, 1054, 1055 & 1056 cam locks  
 All key blanks are nickel plated brass

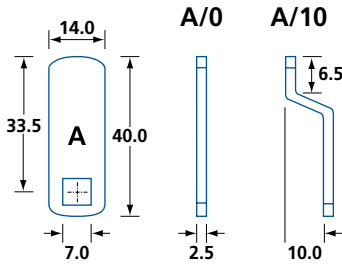

CAM dimensions are in millimetres.

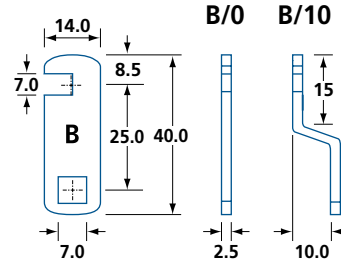

MODEL	DEGREE OF TURN	PLUG POSITION	KEY REMOVAL	KEYWAY	HANDING	øA	øB	C	D	E	/BOX
1003	90°	Vertically offset	Locked	013	Right hand	15/16 (24.0)	1 9/32 (32.8)	1 3/16 (21.0)	2 5/32 (20.0)	2 3/32 (18.3)	12
1004	90°	Vertically offset	Locked	013	Right hand	15/16 (24.0)	1 9/32 (32.8)	1 1/32 (26.0)	2 5/32 (20.0)	2 3/32 (18.3)	12
1005	90°	Vertically offset	Locked	013	Right hand	15/16 (24.0)	1 9/32 (32.8)	1 7/32 (31.0)	2 5/32 (20.0)	2 3/32 (18.3)	12
1012	90°	Centered	Locked or Unlocked	011	Non-handed*	15/16 (24.0)	1 9/32 (32.8)	1 1/16 (17.5)	2 5/32 (20.0)	2 3/32 (18.3)	12
1013	90°	Centered	Locked or Unlocked	013	Non-handed*	15/16 (24.0)	1 9/32 (32.8)	1 3/16 (21.0)	2 5/32 (20.0)	2 3/32 (18.3)	12
1052	180°	Vertically offset	Locked	011	Non-handed*	15/16 (24.0)	1 9/32 (32.8)	1 1/16 (17.5)	2 5/32 (20.0)	2 3/32 (18.3)	12
1053	180°	Vertically offset	Locked	013	Non-handed*	15/16 (24.0)	1 9/32 (32.8)	1 3/16 (21.0)	2 5/32 (20.0)	2 3/32 (18.3)	12
1054	180°	Vertically offset	Locked	013	Non-handed*	15/16 (24.0)	1 9/32 (32.8)	1 1/32 (26.0)	2 5/32 (20.0)	2 3/32 (18.3)	12
1055	180°	Vertically offset	Locked	013	Non-handed*	15/16 (24.0)	1 9/32 (32.8)	1 7/32 (31.0)	2 5/32 (20.0)	2 3/32 (18.3)	12
1056	180°	Vertically offset	Locked	013	Non-handed*	15/16 (24.0)	1 9/32 (32.8)	1 3/8 (35.0)	2 5/32 (20.0)	2 3/32 (18.3)	12

IN (MM) (\*) CONFIGURED FOR RIGHT-HAND USE, CAN BE CONVERTED TO LEFT-HAND

# CAM LOCKS

## SECURITY HARDWARE

### MAILBOX CAM LOCK



S4103

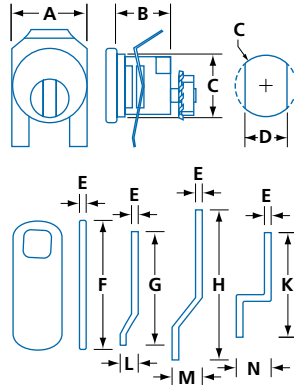

- Nickel plated zinc alloy body with clip mounting
- Panel thickness:  $\frac{1}{16}$ " to  $\frac{3}{16}$ " (1.5 to 4.5 mm)
- Keyable 4-pin tumbler cylinder with brass pins, key only retractable when in locked position
- 2 keys included
- Left turning key
- 4 different cams included
- Packaged in a poly bag
- Finish: nickel plated



S4103KB

- Nickel plated brass key blank

MODEL	øA	B	øC*	D*	E	F	G	H	K	L	M	N	/BOX
S4103	$\frac{7}{8}$ (22.2)	$\frac{21}{32}$ (16.7)	$\frac{3}{4}$ (19)	$\frac{5}{8}$ (16)	$\frac{9}{64}$ (2.0)	$1\frac{17}{32}$ (38.5)	$1\frac{3}{16}$ (30)	$1\frac{13}{16}$ (46)	$\frac{17}{32}$ (31.2)	$\frac{1}{4}$ (6.3)	$\frac{11}{32}$ (8.7)	$\frac{13}{32}$ (10.4)	10

IN (MM) \*FOR HOLE IN PANEL

### MAILBOX CAM LOCK – WITH KEYHOLE SHUTTER



S4103C

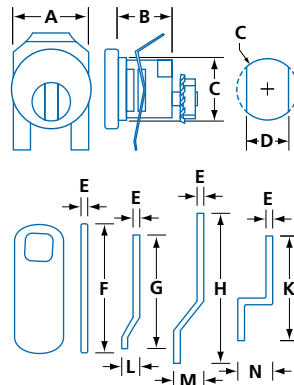

- Nickel plated zinc alloy body with clip mounting
- Panel thickness:  $\frac{1}{16}$ " to  $\frac{3}{16}$ " (1.5 to 4.5 mm)
- Keyable 4-pin tumbler cylinder with brass pins, key only retractable when in locked position
- 2 keys included
- Right turning key
- 4 different cams included
- Includes keyhole shutter - slide shutter to the right with the tip of the key to enter key
- Packaged in a poly bag
- Finish: nickel plated



S4103KB

- Nickel plated brass key blank

MODEL	øA	B	øC*	D*	E	F	G	H	K	L	M	N	/BOX
S4103C	1 (25.4)	$\frac{21}{32}$ (16.7)	$\frac{3}{4}$ (19)	$\frac{5}{8}$ (16)	$\frac{9}{64}$ (2.0)	$1\frac{17}{32}$ (38.5)	$1\frac{3}{16}$ (30)	$1\frac{13}{16}$ (46)	$\frac{17}{32}$ (31.2)	$\frac{1}{4}$ (6.3)	$\frac{11}{32}$ (8.7)	$\frac{13}{32}$ (10.4)	10

IN (MM) \*FOR HOLE IN PANEL



# KEY CABINETS

## SECURITY HARDWARE

### KEY CABINET

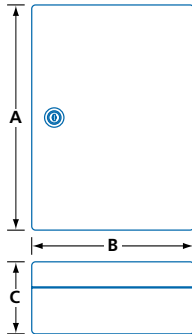

- Sturdy all metal construction with rounded corners allow for greater strength and durability
- Heavy gauge seamless steel
- Scratch-resistant light grey paint
- Rust proof
- Complete with key hooks, key tags, 2 screws and plugs
- Pre-slotted mounting holes
- Lockable cabinet standard KD version, KA version available with purchase of replacement CL50 keyed alike cam locks (see below), 2 keys per cabinet / cam lock supplied



#### CL50

- Replacement cam lock for 50 series key cabinet
- Key is removable in locked or unlocked position with 90° angle rotation
- Suitable for panel thickness up to  $\frac{3}{32}$ " (2.4 mm)
- Available keying KA1, KA2, KD



#### KB50 / KB50-2

- 4 pins
- Nickel plated brass key blank
- Available keyway 101 & 102

MODEL	NUMBER OF KEY HOOKS	A	B	C	/CASE
50-20	20	$9\frac{7}{8}$	$7\frac{1}{8}$	$3\frac{1}{8}$	12
50-40	40	(250)	(180)	(80.5)	8
50-50	50	$11\frac{13}{16}$	$9\frac{1}{8}$	$3\frac{3}{16}$	6
50-70	70	(300)	(230)	(90)	8
50-105	105				
50-120	120	$14\frac{3}{16}$	$9\frac{7}{8}$	$4\frac{3}{8}$	6
50-140	140	(360)	(250)	(110)	

IN (MM)

### EMERGENCY BOX

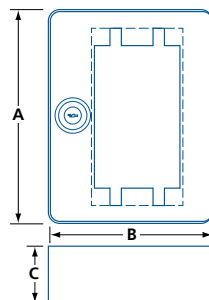

- Sturdy heavy gauge steel construction
- Scratch resistant, painted red
- Single key hook
- Includes steel hammer-rod and cord
- Lockable cabinet; 2 keys supplied
- Pre-drilled mounting holes
- Includes wood screws and plastic anchors
- #EB02G: Replacement glass

MODEL	A	B	C	/CASE
EB-02	$5\frac{29}{32}$	$4\frac{17}{32}$	$1\frac{1}{16}$	25
	(150)	(115)	(40)	

IN (MM)

# KEY RINGS

## SECURITY HARDWARE

### SPLIT KEY RINGS



20600 / TKR



P412

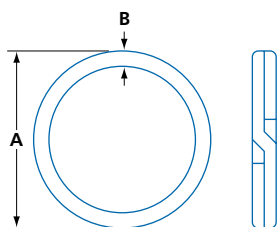

- Strong tempered spring steel split ring (20600 and TKR series)
- Strong tempered steel light-duty split ring (P412 series)
- Finish: nickel plated

MODEL	∅A	B	/ BOX <sup>1</sup>	/ CASE <sup>2</sup>
20616	5/8 (16)	3/64 (1.2)	100	500
20619	3/4 (19)	1/16 (1.6)	100	1000
20623	7/8 (22)	1/16 (1.6)	100	1000
20625	1 (25)	1/16 (1.6)	100	1000
20628	1 1/8 (28.3)	1/16 (1.6)	100	500
20632	1 9/32 (32.2)	5/64 (2.0)	100	500
20635	1 3/8 (35.2)	5/64 (2.0)	100	500
20638	1 1/2 (38)	5/64 (2.0)	100	500
20645	1 3/4 (45)	3/32 (2.4)	50	400
20651	2 (51)	3/32 (2.4)	50	200
TKR16	2 3/16 (55)	3/32 (2.4)	—	50
TKR24	3 (76)	1/8 (3.2)	—	25
P412A	5/8 (16)	1/16 (1.6)	10,000	40,000
P412B	1 (25)	1/16 (1.6)	1,000	20,000

IN (MM) (1) UNITS PER BAG (2) UNITS PER CASE

### PULL-APART KEY RING

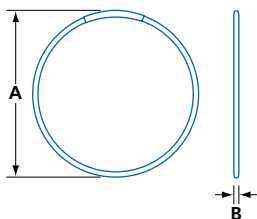

- Pull-apart tempered steel key ring
- Finish: nickel plated

MODEL	∅A	B	/ BOX
PAR3	3 3/4 (95)	1/8 (3.1)	25
PAR4	5 (127)	1/8 (3.1)	25
PAR6	6 (152)	1/8 (3.1)	25

IN (MM)

### HOOK KEY RING

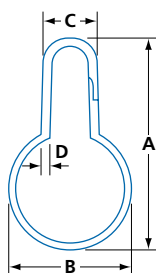

- Tempered steel hook key ring

MODEL	A	∅B	C	D	/ BOX
CP4	2 11/16 (68.6)	1 1/16 (39.7)	11/16 (17.6)	1/8 (3)	100

IN (MM)



# KEY RINGS & TAGS

SECURITY HARDWARE

## keyline EASY-JOIN KEY RING

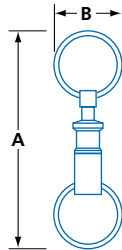

- Easy-join key ring with 2 tempered steel spring split rings and solid brass coupling
- Finish: nickel plated
- Retail card display with 12 key rings
- Not sold individually

MODEL	A	∅B	/BOX
D603B	3 <sup>1</sup> / <sub>8</sub> (80)	1 (25.4)	120

IN (MM)

## keyline KEY TAG WITH SPLIT RING

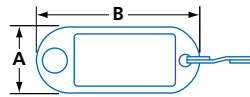

- Coloured plastic label holder with split ring
- H8036: 100 pieces per box
- Available colors: black, blue, light green, orange, purple, red and yellow
- Display box also available as H8036STV200 with 200 pieces of 8 different colors: black, blue, light blue, light green, orange, purple, red and yellow



H8036STV200

MODEL	A	B	/BOX
H8036	7 <sup>7</sup> / <sub>8</sub> (21.5)	2 (51.0)	100
H8036STV200	7 <sup>7</sup> / <sub>8</sub> (21.5)	2 (51.0)	200

IN (MM)

## keyline KEY TAG WITH SPLIT RING

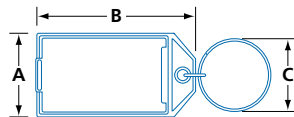

- Durable key tag with split ring
- Made from polypropylene
- Open and close flap with identification paper insert
- Available colors: blue, clear, green, magenta, orange, purple, red, and yellow

MODEL	A	B	∅C	/BOX
H8040	1 <sup>5</sup> / <sub>32</sub> (29.5)	2 <sup>9</sup> / <sub>32</sub> (57.8)	1 (25.4)	100

IN (MM)

# KEY RINGS & TAGS

## SECURITY HARDWARE

### BRASS KEY TAG

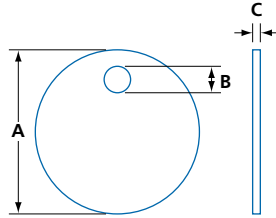

- Solid polished brass tag
- For engraving
- 1¼" (31.8 mm) diameter
- 100 pieces per poly bag

MODEL	øA	B	C	/BOX
104.120	1¼ (31.8)	⅜ (5.0)	⅛ (1.0)	500

IN (MM)

