



COMMERCIAL & RESIDENTIAL HINGES TABLE OF CONTENTS

Door Handing guide	ii
Finish Guide.....	ii
Abbreviation Guide.....	iii
COMMERCIAL HINGES	
DOREX BB1079, Full Mortise, Ball Bearing.....	04.016
DOREX CB1079, Full Mortise, Concealed Ball Bearing	04.018
DOREX PRO 1168, Full Mortise, Heavy Duty Ball Bearing	04.020
DOREX 1198, Full Mortise, Heavy Duty Ball Bearing	04.021
DOREX BB1068, Full Mortise, Heavy Duty Ball Bearing	04.022
DOREX 143, Full Mortise, Plain Bearing	04.031
DOREX BB1073, Half Surface, Ball Bearing	04.041
DOREX BB1077, Half Mortise, Ball Bearing.....	04.046
DOREX BB1048, Swing Clear, Ball Bearing	04.051
DOREX 1265, Reinforcement Hinge	04.060
Reinforcement & Filler Plates.....	04.065
DOREX 3310, Single Acting Spring Hinge.....	04.070
1310, Single Acting Spring Hinge.....	04.071
Commercial Spring Hinges.....	04.075
DOREX 1020, Universal Replacement Hinge.....	04.080
RESIDENTIAL HINGES	
Ball Bearing.....	04.100
Plain Bearing.....	04.101
Steel Entry	04.102
Decorative	04.103
Spring Hinge.....	04.103
Door Springs.....	04.104
CONTINUOUS GEARED HINGES	
ABH Continuous Geared Hinges BHMA	04.200
DOREX CGH Continuous Geared Hinges.....	04.210
PIVOTS	
Offset	04.300
Center Hung.....	04.311
Intermediate	04.312
Spring & Gravity Pivots.....	04.320
PATCH FITTINGS	
Glass Doors & Panels.....	04.400
ASSORTED	
Strap, Tee and Back Flap Hinges.....	04.500
Miscellaneous Hinges.....	04.501
Continuous (Piano) Hinges.....	04.502
SPECIALTY	
Invisible Hinges	04.600
Power Transfers	04.610

R20206618



DOOR HANDING GUIDE

LEFT HAND (LH)

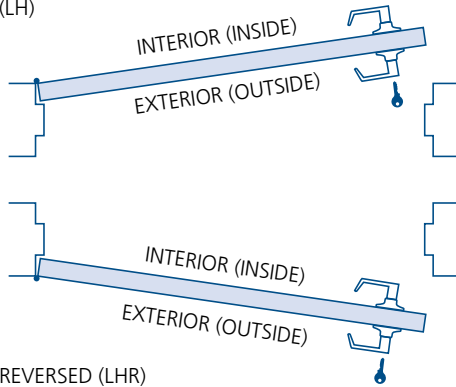

LEFT HAND REVERSED (LHR)

RIGHT HAND (RH)

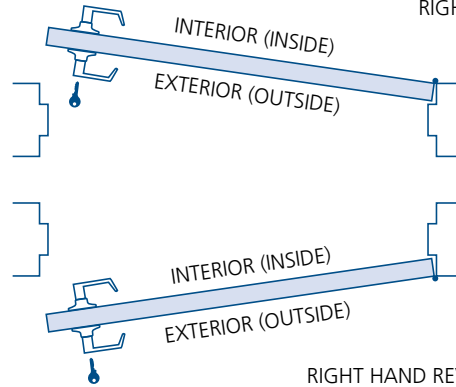

RIGHT HAND REVERSED (RHR)

FINISH GUIDE

PRIME COATED	BLACK JAPANED / LACQ.	MATTE BLACK LACQUER	ZINC PLATED	YELLOW ZINC PLATED
CODE CP	C1B, KJ	C1D	C2G, ZP	C2GY, YZ
BHMA* 600	601	693	603	
POLISHED BRASS	MIRROR POLISHED BRASS	SATIN BRASS	ANTIQU BRASS	ANTIQU BRONZE
BP, PB, C3, 3	C3M, 3M	C4, 4, SDB	AB, C5, 5	C11P, 11P
BHMA* 605, 632		606, 633	609, 638	617, 644
SATIN NICKEL	ANTIQU NICKEL	MATTE BLACK	DARK BRONZE / DURANODIC	POLISHED CHROME
SDN, SN, C15, 15	C15A, 15A	C19, 19	BLR, DU, C20D, 20D, C20	C26, 26
BHMA* 619, 646	620, 647	622, 631	650, 690, 695, 710	625, 651
SATIN CHROME	POLISHED STAINLESS STEEL	SATIN STAINLESS STEEL	ALUMINUM	PLAIN STEEL, NO FINISH
SC, C26D, 26D	C32, 32	SS, C32D, 32D	AL, C28, 28	PS
BHMA* 262, 652	629	630	628, 689	

ALL FINISHES IMAGES ABOVE ARE PHOTOGRAPHIC OR COLOUR APPROXIMATIONS, DELIVERED PRODUCT MAY VARY IN COMPARISON OR BETWEEN ORDERS/LOTS.

OTHER FINISHES AVAILABLE—PLEASE CONTACT.



(*) EQUIVALENT; CODES DIFFER DEPENDING ON BASE MATERIAL AND/OR FINISH PROCESS.

ABBREVIATION GUIDE

GENERAL

DIA, \varnothing	Diameter
KG	Kilograms
LBS	Pounds
LH	Left hand
LHR	Left hand reversed
MAX	Maximum
MIN	Minimum
N/A, —	Not applicable / Not available
QTY	Quantity (usually followed by notes)
RH	Right hand
RHR	Right hand reversed
SQ, \square	Square
WT	Weight
/UNIT	Number of items per basic unit of sale (bagged or boxed)
/BOX, /BAG	Number of UNITS found in an inner carton or bag
/CASE	Number of BOXES or UNITS found in an outer (shipping) carton

LEGEND

	Tested to Canadian and/or American safety and performance standards by Underwriters Laboratories® (UL).
	Hinge available with rounded corners at indicated radius.
	Hinge mounting holes follow template hole pattern outlined by ANSI/BHMA A156.7.



COMMERCIAL HINGES

FULL MORTISE HINGES

DOREX BB1079 BALL BEARING TEMPLATE HINGE



- Standard weight, full mortise
- 5 knuckles, 2 ball bearings
- Steel with steel pin
- Conforms to ANSI/BHMA A156.1
- ANSI/BHMA A156.7 template hole pattern

OPTIONS

- NRP: Non-removable pin
- A: NRP, radius corners: 1/4" (6.4 mm)*
- B: NRP, radius corners: 5/32" (4 mm)*

(*) Radius corners are only available for size 454 (4x4 1/2 in) hinges.

- Non-handed
- Flat tips with knock-out bottom
- Wood and undercut machine screws included

BB1079 - 454 - * - 26D - NRP

MODEL	SIZE	CORNER	FINISH	OPTION
(*) LEAVE BLANK FOR SQUARE CORNERS.				

(*) LEAVE BLANK FOR SQUARE CORNERS.

SIZE	INCHES	MM	GAUGE	HOLES	SCREWS INCLUDED		QTY ¹
					MACHINE	WOOD	
3535*	3 1/2 x 3 1/2	88.9 x 88.9	0.123	6	#10-24 x 1/2	#9 x 1	3/60
44*	4 x 4	101.6 x 101.6	0.130	8	#12-24 x 1/2	#12 x 1 1/4	3/60
454*	4 1/2 x 4	114.3 x 101.6	0.134	8	#12-24 x 1/2	#12 x 1 1/4	3/60
4545*	4 1/2 x 4 1/2	114.3 x 114.3	0.134	8	#12-24 x 1/2	#12 x 1 1/4	3/60
545*	5 x 4 1/2	127 x 114.3	0.146	8	#12-24 x 1/2	#12 x 1 1/4	3/30
55*	5 x 5	127.0 x 127.0	0.146	8	#12-24 x 1/2	#12 x 1 1/4	3/36

(1) 3/60: QUANTITY PER BOX / QUANTITY PER CASE. HINGES NOT SOLD INDIVIDUALLY. (*) FIRE RATING AS PER NFPA80 GUIDELINES.

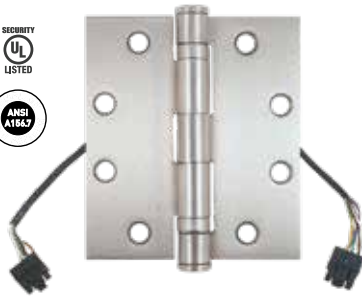

4-WIRE (28 AWG)
JC-603QC-BB1079-454-26D-ETW04

8-WIRE (28 AWG)
JC-603QC-BB1079-454-26D-ETW08

For more information and available finishes, see page 04.620

1D	15	2G	26	26D	32D ¹	BLR	P
MATTE BLACK LACQUER	SATIN NICKEL	ZINC PLATED	POLISHED CHROME	SATIN CHROME	SATIN STAINLESS STEEL	DARK BRONZE	PRIME COATED

OTHER SIZES AND FINISHES AVAILABLE BY SPECIAL ORDER, PLEASE CONTACT FOR DETAILS.

(1) AVAILABLE ONLY FOR 454, 55 SIZES WITH NRP.

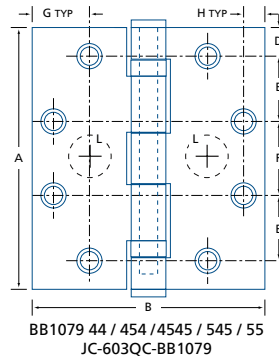
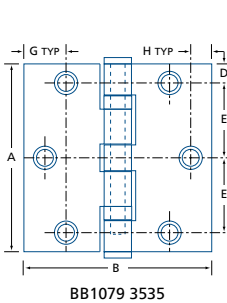

MODEL	A	B	C	D	E	F	G	H	K	L*
BB1079 3535	3 1/2 (88.9)	3 1/2 (88.9)	1/2 (12.7)	23/64 (9.1)	125/64 (35.4)	—	11/16 (17.5)	23/64 (9.1)	1/16 (1.6)	—
BB1079 44	4 (101.6)	4 (101.6)	9/16 (14)	1/2 (12.7)	1 (25.5)	31/32 (24.6)	3/4 (19.1)	3/8 (9.5)	1/16 (1.6)	—
BB1079 454 JC-603QC	4 1/2 (114.3)	4 (101.6)	19/32 (15.2)	1/2 (12.7)	1 1/8 (28.6)	1 15/64 (31)	1 (25.4)	3/8 (9.5)	1/16 (1.6)	Ø 19/32 (15)
BB1079 4545	4 1/2 (114.3)	4 1/2 (114.3)	19/32 (15.2)	1/2 (12.7)	1 1/8 (28.6)	1 15/64 (31)	1 (25.4)	3/8 (9.5)	1/16 (1.6)	—
BB1079 545	5 (127.0)	4 1/2 (114.3)	5/8 (15.9)	1/2 (12.7)	1 1/4 (31.8)	1 31/64 (37.7)	1 (25.4)	3/8 (9.5)	1/16 (1.8)	Ø 19/32 (15)
BB1079 55	5 (127)	5 (127)	5/8 (15.9)	1/2 (12.7)	1 1/4 (31.8)	1 31/64 (37.7)	1 (25.4)	3/8 (9.5)	1/16 (1.6)	—

DIMENSIONS IN INCHES (MILLIMETRES) AS PER ANSI A156.7

*DIMENSION OF THE NODE, NOT THE FRAME PREPARATION.

COMMERCIAL HINGES

FULL MORTISE HINGES

DOREX CB1079 CONCEALED BALL BEARING TEMPLATE HINGE



- Standard weight, full mortise
- 3 knuckles, concealed ball bearing
- Steel or stainless steel hinge and pin
- Conforms to ANSI/BHMA A156.1
- ANSI/BHMA A156.7 template hole pattern
- Non-handed
- Flush tips
- Wood and undercut machine screws included

CB1079	C26D	454	NRP
MODEL	FINISH	SIZE	OPTION

SIZE	INCHES	MM	GAUGE	HOLES	SCREWS INCLUDED MACHINE	SCREWS INCLUDED WOOD	QTY ¹
454*	4 1/2 x 4	114.3 x 101.6	0.134	8	#12-24 x 1/2	#12 x 1 1/4	3/60

(1) 3/60 : QUANTITY PER BOX / QUANTITY PER CASE. HINGES NOT SOLD INDIVIDUALLY. (*) FIRE RATING AS PER NFPA80 GUIDELINES.

C26D

SATIN
CHROME

OTHER SIZES AND FINISHES AVAILABLE BY SPECIAL ORDER, PLEASE CONTACT FOR DETAILS.
(1) ALL SATIN STAINLESS STEEL HINGES (C32D) ARE 18-8 STAINLESS STEEL AND ARE NRP BY DEFAULT.

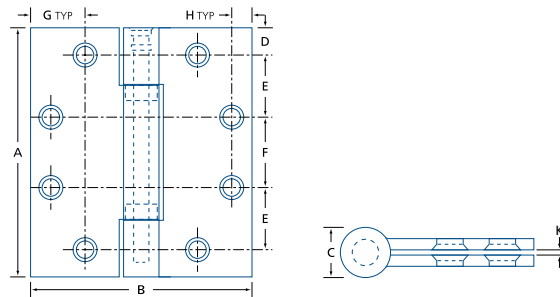

MODEL	A	B	C	D	E	F	G	H	K
CB1079 454	4 1/2 (114.3)	4 (101.6)	19/32 (15.2)	1/2 (12.7)	1 1/8 (28.6)	1 15/64 (31)	1 (25.4)	3/8 (9.5)	1/16 (1.6)

DIMENSIONS IN INCHES (MILLIMETRES) AS PER ANSI A156.7



COMMERCIAL HINGES

FULL MORTISE HINGES

DOREX PRO 1168 HEAVY DUTY BALL BEARING TEMPLATE HINGE



- Heavy weight, full mortise
- 5 knuckles, 4 ball bearings
- Steel or stainless steel hinge and pin
- Conforms to ANSI/BHMA A156.1
- ANSI/BHMA A156.7 template hole pattern

OPTIONS

B: Radius corners: $\frac{5}{32}$ " (4mm)

- Non-handed
- Flat tips with knock-out bottom
- Non-removable pin (NRP)
- Wood screws and undercut machine screws included

1168	C32D	454	B
MODEL	FINISH	SIZE	OPTION

SIZE	INCHES	MM	GAUGE	HOLES	SCREWS INCLUDED		QTY ¹
					MACHINE	WOOD	
454*	4 1/2 x 4	114.3 x 101.6	0.1875	8	#12-24 x 1/2	#12 x 1 1/4	3/60

(1) 3/60 : QUANTITY PER BOX / QUANTITY PER CASE. HINGES NOT SOLD INDIVIDUALLY. (*) FIRE RATING AS PER NFPA80 GUIDELINES.

C15	C32D
SATIN NICKEL	SATIN STAINLESS STEEL

OTHER SIZES AND FINISHES AVAILABLE BY SPECIAL ORDER, PLEASE CONTACT FOR DETAILS.

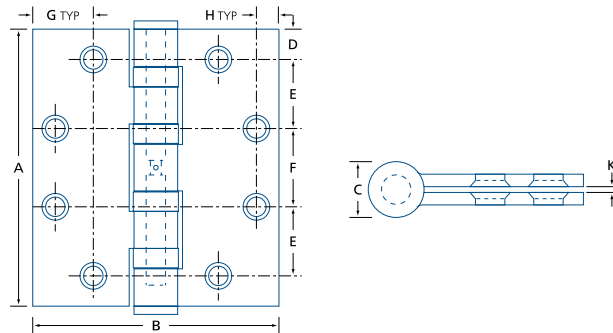

MODEL	A	B	C	D	E	F	G	H	K
1168 454	4 1/2 (114.3)	4 (101.6)	19/32 (15.2)	1/2 (12.7)	1 1/8 (28.6)	1 15/64 (31)	1 (25.4)	3/8 (9.5)	1/16 (1.6)

DIMENSIONS IN INCHES (MILLIMETRES) AS PER ANSI A156.7

COMMERCIAL HINGES

FULL MORTISE HINGES

DOREX 1198 HEAVY DUTY BALL BEARING TEMPLATE HINGE



- Heavy weight, full mortise
- 5 knuckles, 4 ball bearings
- Steel or stainless steel hinge and pin
- Conforms to ANSI/BHMA A156.1
- ANSI/BHMA A156.7 template hole pattern
- Non-handed
- Flat tips with knock-out bottom
- Non-removable pin (NRP)
- Wood screws and undercut machine screws included

1198	C26D	454
MODEL	FINISH	SIZE

SIZE	INCHES	MM	GAUGE	HOLES	SCREWS INCLUDED		QTY ¹
					MACHINE	WOOD	
454*	4 1/2 x 4	114.3 x 101.6	0.1875	8	#12-24 x 1/2	#12 x 1 1/4	3/60

(1) 3/60 : QUANTITY PER BOX / QUANTITY PER CASE. HINGES NOT SOLD INDIVIDUALLY. (*) FIRE RATING AS PER NFPA80 GUIDELINES.

C26D	C32D
SATIN CHROME	SATIN STAINLESS STEEL

OTHER SIZES AND FINISHES AVAILABLE BY SPECIAL ORDER, PLEASE CONTACT FOR DETAILS.

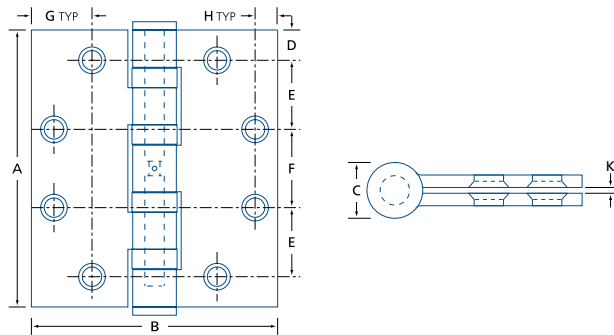

MODEL	A	B	C	D	E	F	G	H	K
1198 454	4 1/2 (114.3)	4 (101.6)	19/32 (15.2)	1/2 (12.7)	1 1/8 (28.6)	1 15/64 (31)	1 (25.4)	3/8 (9.5)	1/16 (1.6)

DIMENSIONS IN INCHES (MILLIMETRES) AS PER ANSI A156.7



COMMERCIAL HINGES

FULL MORTISE HINGES

DOREX BB1068 HEAVY DUTY BALL BEARING TEMPLATE HINGE



- Heavy weight, full mortise
- 5 knuckles, 4 ball bearings
- Steel or stainless steel hinge and pin
- Conforms to ANSI/BHMA A156.1
- ANSI/BHMA A156.7 template hole pattern
- Non-handed
- Flat tips with knock-out bottom
- Wood screws and undercut machine screws included

OPTIONS

NRP: Non-removable pin (NRP)

BB1068	-	4545	-	26D	-	NRP
MODEL	SIZE	FINISH	OPTION			

SIZE	INCHES	MM	GAUGE	HOLES	SCREWS INCLUDED		QTY ¹
					MACHINE	WOOD	
4545*	4 1/2 x 4 1/2	114.3 x 114.3	0.180	8	#12-24 x 1/2	#12 x 1 1/4	3/48
545*	5 x 4 1/2	127 x 114.3	0.190	8	#12-24 x 1/2	#12 x 1 1/4	3/48
55*	5 x 5	127 x 127	0.190	8	#12-24 x 1/2	#12 x 1 1/4	3/48

(1) 3/48 : QUANTITY PER BOX / QUANTITY PER CASE. HINGES NOT SOLD INDIVIDUALLY. (*) FIRE RATING AS PER NFPA80 GUIDELINES.

P	26D	32D
PRIME COATED	SATIN CHROME	SATIN STAINLESS STEEL

OTHER SIZES AND FINISHES AVAILABLE BY SPECIAL ORDER, PLEASE CONTACT FOR DETAILS.

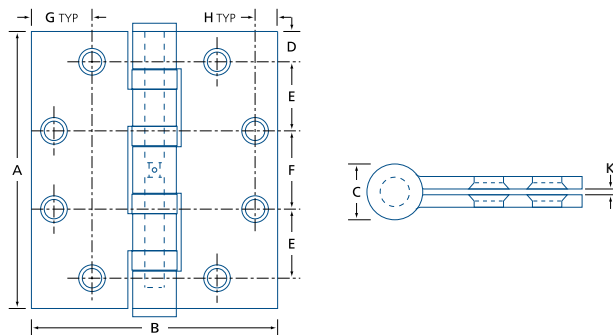

MODEL	A	B	C	D	E	F	G	H	K
BB1068 4545	4 1/2 (114.3)	4 1/2 (114.3)	3/4 (19)	1/2 (12.7)	1 1/8 (28.6)	1 15/64 (31)	1 (25.4)	3/8 (9.5)	1/16 (1.8)
BB1068 545	5 (127.0)	4 1/2 (114.3)	3/4 (19)	1/2 (12.7)	1 1/8 (28.6)	1 15/64 (31)	1 (25.4)	3/8 (9.5)	1/16 (1.8)
BB1068 55	5 (127.0)	5 (127.0)	3/4 (19)	1/2 (12.7)	1 1/4 (31.8)	1 15/32 (37.7)	1 (25.4)	3/8 (9.5)	1/16 (1.8)

DIMENSIONS IN INCHES (MILLIMETRES) AS PER ANSI A156.7

COMMERCIAL HINGES

FULL MORTISE HINGES

DOREX 143 PLAIN BEARING TEMPLATE HINGE



- Standard weight, full mortise
- 5 knuckles, plain bearing
- Steel with non-rising steel pin
- ANSI/BHMA A156.7 template hole pattern
- Non-handed
- Flat tips with knock-out bottom
- Wood and undercut machine screws included

143	C15	454
MODEL	FINISH	SIZE

SIZE	INCHES	MM	GAUGE	HOLES	SCREWS INCLUDED MACHINE	WOOD	QTY ¹
454	4½ x 4	114.3 x 101.6	0.134	8	#12-24 x ½	#12 x 1¼	3/60

(1) 3/60 : QUANTITY PER BOX / QUANTITY PER CASE. HINGES NOT SOLD INDIVIDUALLY.

C15
SATIN NICKEL

OTHER SIZES AND FINISHES AVAILABLE BY SPECIAL ORDER, PLEASE CONTACT FOR DETAILS.

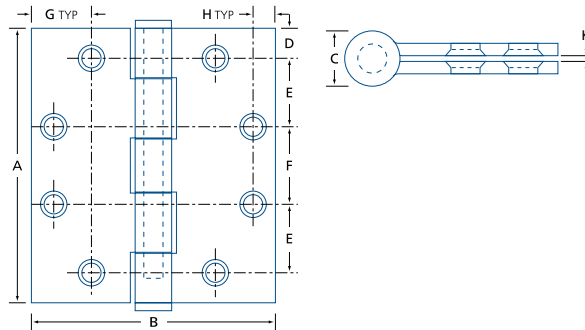

MODEL	A	B	C	D	E	F	G	H	K
143 454	4½ (114.3)	4 (101.6)	19/32 (15.2)	½ (12.7)	1⅛ (28.6)	1¹⁵/₆₄ (31)	1 (25.4)	¾ (9.5)	⅛ (1.6)

DIMENSIONS IN INCHES (MILLIMETRES) AS PER ANSI A156.7

COMMERCIAL HINGES

FULL MORTISE HINGES

DOREX 1079/1091 PLAIN BEARING TEMPLATE HINGE



- Standard weight, full mortise
- 5 knuckles, plain bearing
- Steel or stainless steel hinge and pin
- ANSI/BHMA A156.7 template hole pattern

- Non-handed
- Flat tips with knock-out bottom
- Wood and undercut machine screws included

MODELS

- 1079: Steel hinge and pin
- 1091: Stainless steel hinge and pin

OPTIONS

- N: Non-removable pin (NRP)

1079	-	44	-	26D	-	N
MODEL		SIZE		FINISH		OPTION

SIZE	INCHES	MM	GAUGE	HOLES	SCREWS INCLUDED		QTY ¹
					MACHINE	WOOD	
3535	3½ x 3½	88.9 x 88.9	0.125	6	#10-24 x ½	#9 x 1	3/48
44	4 x 4	101.6 x 101.6	0.130	8	#12-24 x ½	#12 x 1¼	3/48
4545	4½ x 4½	114.3 x 114.3	0.134	8	#12-24 x ½	#12 x 1¼	3/48

(1) 3/48 : QUANTITY PER BOX / QUANTITY PER CASE. HINGES NOT SOLD INDIVIDUALLY.

P	26D	32D*
PRIME COATED	SATIN CHROME	SATIN STAINLESS STEEL

OTHER SIZES AND FINISHES AVAILABLE BY SPECIAL ORDER, PLEASE CONTACT FOR DETAILS.
 (*) 304 STAINLESS STEEL, 1091-4545 ONLY

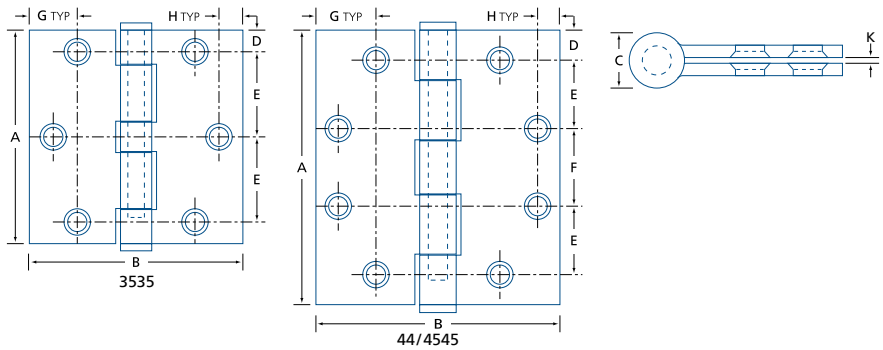

MODEL	A	B	C	D	E	F	G	H	K
1079/1091 3535	3½ (88.9)	3½ (88.9)	½ (12.7)	23/64 (9.1)	125/64 (35.4)	—	11/16 (17.5)	23/64 (9.1)	1/16 (1.6)
1079/1091 44	4 (101.6)	4 (101.6)	9/16 (14)	½ (12.7)	1 (25.5)	31/32 (24.6)	3/4 (19.1)	3/8 (9.5)	1/16 (1.6)
1079/1091 4545	4½ (114.3)	4½ (114.3)	19/32 (15.2)	½ (12.7)	1 1/8 (28.6)	1 15/64 (31)	1 (25.4)	3/8 (9.5)	1/16 (1.6)

DIMENSIONS IN INCHES (MILLIMETRES) AS PER ANSI A156.7

COMMERCIAL HINGES

HALF SURFACE HINGES

DOREX BB1073 HALF SURFACE TEMPLATE HINGE



- Standard weight, half surface
- 5 knuckles, 2 ball bearings
- Steel with steel pin
- ANSI/BHMA A156.7 template hole pattern
- Handed
- Flat tips with knock-out bottom
- Non-removable pin (NRP)
- High quality primer coat finish (CP)

BB1073	L	-	45	-	P	-	N
MODEL	HAND	SIZE	FINISH				

L : LEFT HAND R : RIGHT HAND

SIZE	HINGE SIZE INCHES	MM	GAUGE	HOLES	BOLT / SCREWS INCLUDED BOLT	WOOD	QTY ¹
45	4 1/2	114.3	0.134	7	#1/4 x 20 (x3)*	#12 x 1 1/4 (x4)	3/48
50	5	127	0.146	8	#1/4 x 20 (x3)*	#12 x 1 1/4 (x4)	3/48

(*) FOR DOORS 1 3/4" (45MM) THICK (1) 3/48 : QUANTITY PER BOX / QUANTITY PER CASE. HINGES NOT SOLD INDIVIDUALLY.

P
PRIME COATED

OTHER SIZES AND FINISHES AVAILABLE BY SPECIAL ORDER, PLEASE CONTACT FOR DETAILS.

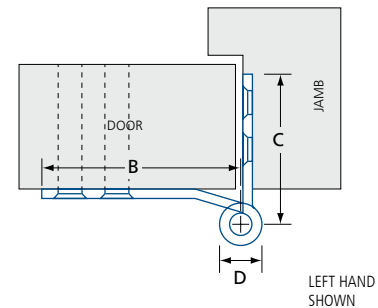
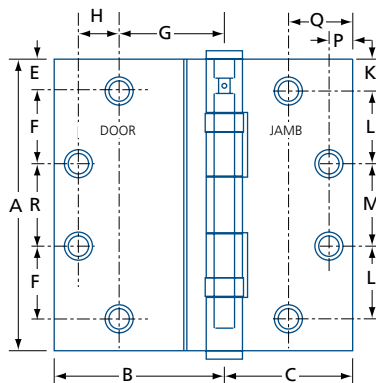
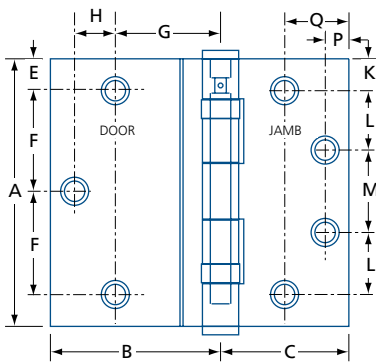

MODEL	A	B	C	D	E	F	G	H	K	L	M	P	Q	R
BB1073 45	4 1/2 (114.3)	2 9/16 (65)	2 1/16 (52.4)	39/64 (15.4)	1/2 (12.7)	1 3/4 (44.5)	1 1/2 (38.1)	9/16 (14.3)	1/2 (12.7)	1 1/8 (28.6)	1 7/32 (31.3)	3/8 (9.5)	1 (25.4)	—
BB1073 50	5 (127)	2 7/8 (73.0)	2 1/16 (52.4)	5/8 (15.8)	1/2 (12.7)	1 1/4 (31.8)	1 1/2 (38.1)	7/8 (22.2)	1/2 (12.7)	1 1/4 (31.8)	1 31/64 (37.7)	3/8 (9.5)	1 (25.4)	1 1/2 (38.1)

IN(MM)

COMMERCIAL HINGES

HALF MORTISE HINGES

DOREX BB1077 HALF MORTISE TEMPLATE HINGE



- Standard weight, half mortise
- 5 knuckles, 2 ball bearings
- Steel with steel pin
- ANSI/BHMA A156.7 template hole pattern
- Handed
- Flat tips with knock-out bottom
- Wood and undercut machine screws and through-bolts included

OPTIONS

N: Non-removable pin (NRP)

BB1077	L	-	45	-	P	-	N
MODEL	HAND	SIZE	FINISH				

L : LEFT HAND R : RIGHT HAND

SIZE	HINGE SIZE		GAUGE	HOLES	BOLT / SCREWS INCLUDED		QTY ¹
	INCHES	MM			BOLT	WOOD	
45	4 1/2	114.3	0.134	7	#1/4x20 (x3)*	#12x1 1/4(x4)	3/48

(*) FOR DOORS 1 3/4" (45 MM) THICK (1) 3/48 : QUANTITY PER BOX / QUANTITY PER CASE. HINGES NOT SOLD INDIVIDUALLY.

P
PRIME COATED

OTHER SIZES AND FINISHES AVAILABLE BY SPECIAL ORDER, PLEASE CONTACT FOR DETAILS.

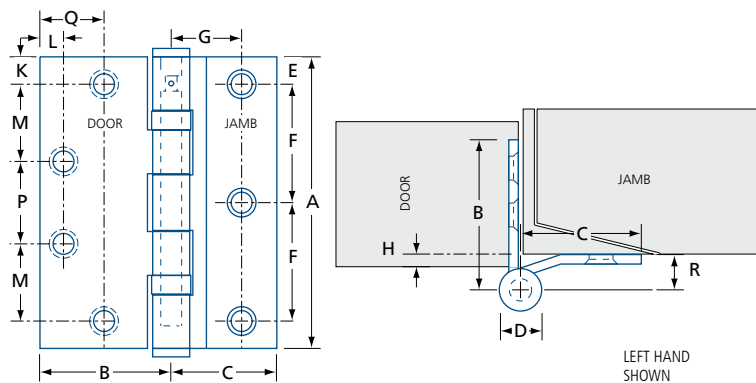

MODEL	A	B	C	D	E	F	G	H	K	L	M	P	Q
BB1077 45	4 1/2 (114.3)	2 1/16 (52.4)	1 1/2 (38)	19/32 (15)	1/2 (12.7)	1 3/4 (44.5)	1 (25.4)	—	1/2 (12.7)	3/8 (9.5)	1 1/8 (28.6)	17/32 (31.3)	1 (25.4)

IN (MM)



COMMERCIAL HINGES

SWING CLEAR HINGES

DOREX BB1048 SWING CLEAR TEMPLATE HINGE



- Standard weight
- 5 knuckles, 2 ball bearings
- Steel with non-rising steel pin
- ANSI/BHMA A156.7 template hole pattern
- Allows door to fully clear door opening
- For non-bevelled (square) doors
- Handed, field reversible
- Flat tips with knock-out bottom

BB1048 L - 454 - 15

MODEL HAND SIZE FINISH

L: LEFT HAND R: RIGHT HAND

SIZE	INCHES	MM	GAUGE	HOLES	SCREWS INCLUDED		QTY ¹
					MACHINE	WOOD	
454*	4 1/2 x 4	114.3 x 101.6	0.134	8	#12-24 x 1/2	#12 x 1 1/4	3/30

(1) 3/30 : QUANTITY PER BOX / QUANTITY PER CASE. HINGES NOT SOLD INDIVIDUALLY. (*) FIRE RATING AS PER NFPA80 GUIDELINES. OTHER FINISHES AVAILABLE BY SPECIAL ORDER, PLEASE CONTACT FOR DETAILS.

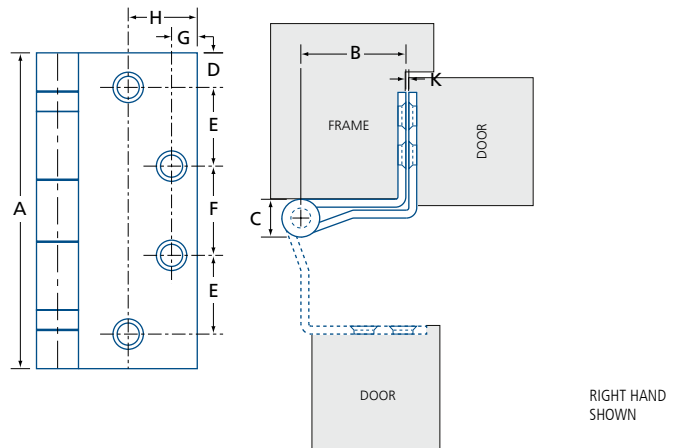

MODEL	A	B	C	D	E	F	G	H	K
BB1048 454	4 1/2 (114.3)	1 5/8 (41.3)	19/32 (15.2)	1/2 (12.9)	1 1/8 (28.6)	1 15/64 (31.3)	3/8 (9.5)	1 (25.4)	1/16 (1.6)

IN(MM)

COMMERCIAL HINGES

REINFORCEMENT HINGES & PLATES

DOREX PRO 1265 REINFORCEMENT HINGE



1265RH

- Heavy weight, full surface
 - 2 knuckles, 1 ball bearings
 - Steel with steel fixed pin
- Reinforces sagging or unevenly hung doors
 - Handed
 - Mounting hardware:
 - » Wood screws
 - » Machine screws
 - » Thru-bolts with sexnut for 1¾" (44.5) door
 - » Threaded Jack-Nut inserts with installation tool

1265	RH
MODEL	HAND
LH : LEFT HAND RH : RIGHT HAND	

MODEL	HINGE SIZE		FINISH	HOLES	SCREWS INCLUDED		QTY ¹
	INCHES	MM			WOOD	MACHINE	
1265	3¼ x 6⅞	82.6 x 155.7	Satin zinc plated	9	¼ x 1½	¼-20 x 1	1/30

(1) 1/30 : QUANTITY PER BOX / QUANTITY PER CASE.

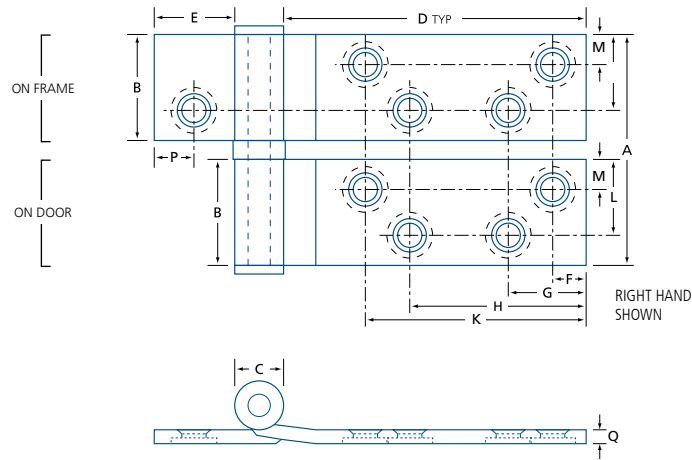

MODEL	A	B	C	D	E	F	G	H	K	M	P	Q
1265	3¼ (82.5)	1½ (38.1)	11/16 (17.5)	49/16 (109)	15/32 (29.1)	½ (12.7)	11/8 (28.6)	23/8 (60.30)	3 (76.2)	½ (12.7)	5/8 (16)	0.190 (4.8)

IN (MM)

COMMERCIAL HINGES

REINFORCEMENT & FILLER PLATES

DOREX REINFORCEMENT & FILLER PLATES

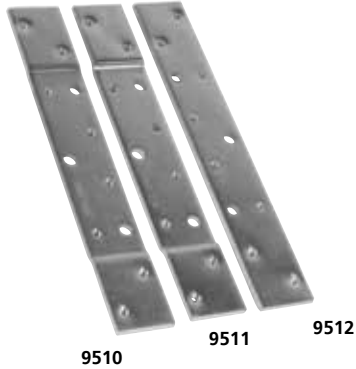

- Steel reinforcement plate
- ANSI/BHMA A156.7 template hole pattern
- Available with various offsets
- Holes accommodate #12-24 screws
- Fastening hardware NOT included

MODEL	FINISH	DESCRIPTION	QTY ⁽¹⁾
9510	Zinc plated	8 x 1 ³ / ₁₆ " (201 x 30 mm) Template reinforcement plate for 4 ¹ / ₂ " (114.3) hinge, with ³ / ₃₂ " (2.5) offset	12/120
9511	Zinc plated	8 x 1 ³ / ₁₆ " (201 x 30 mm) Template reinforcement plate for 4 ¹ / ₂ " (114.3 mm) hinge, with ¹ / ₁₆ " (1.2 mm) offset	12/120
9512	Zinc plated	8 x 1 ³ / ₁₆ " (201 x 30 mm) Template reinforcement plate for 4 ¹ / ₂ " (114.3 mm) hinge, flat, no offset	12/120

(1) 12/120 : QUANTITY PER BOX / QUANTITY PER CASE.



- Steel filler plate
- ANSI/BHMA A156.7 template hole pattern
- Holes accommodate #12-24 screws
- Fastening hardware included

MODEL	FINISH	DESCRIPTION	QTY ⁽¹⁾
9515EXW	White epoxy	Template filler plate for 4 ¹ / ₂ x 1 ¹ / ₂ " (114.3 x 38 mm) hinge leaf	50/150
9515ZP	Zinc plated		

(1) 50/150 : QUANTITY PER BOX / QUANTITY PER CASE.

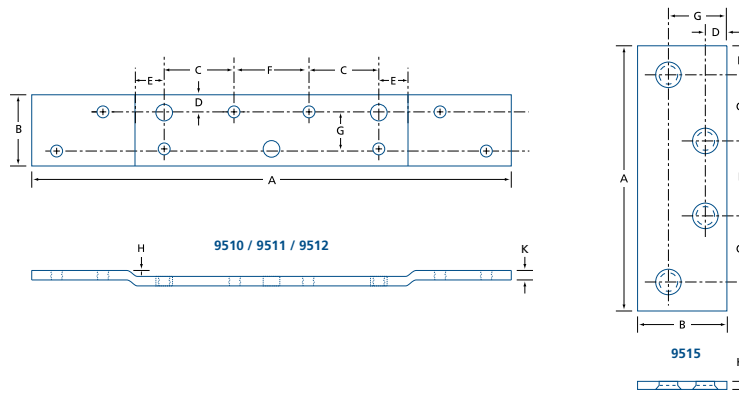

MODEL	A	B	C	D	E	F	G	H	K
9510	7 ¹⁵ / ₁₆ (202)	1 ³ / ₁₆ (30)	1 ¹ / ₈ (28.6)	1 ⁷ / ₆₄ (6.7)	1 ⁷ / ₃₂ (13.5)	1 ¹⁵ / ₆₄ (31)	5/ ₈ (15)	3/ ₃₂ (2.5)	5/ ₃₂ (4)
9511	7 ¹⁵ / ₁₆ (202)	1 ³ / ₁₆ (30)	1 ¹ / ₈ (28.6)	1 ⁷ / ₆₄ (6.7)	1 ⁷ / ₃₂ (13.5)	1 ¹⁵ / ₆₄ (31)	5/ ₈ (15)	1/ ₁₆ (1.2)	5/ ₃₂ (4)
9512	7 ¹⁵ / ₁₆ (202)	1 ³ / ₁₆ (30)	1 ¹ / ₈ (28.6)	1 ⁷ / ₆₄ (6.7)	1 ⁷ / ₃₂ (13.5)	1 ¹⁵ / ₆₄ (31)	5/ ₈ (15)	—	5/ ₃₂ (4)
9515	4 1/2 (114.3)	1 1/2 (38.1)	1 ¹ / ₈ (28.6)	3/ ₈ (9.5)	33/ ₆₄ (13.1)	1 ¹⁵ / ₆₄ (31)	1 (25.4)	—	5/ ₃₂ (4)

DIMENSIONS IN INCHES (MILLIMETRES) AS PER ANSI A156.7



COMMERCIAL HINGES

SPRING HINGES

DOREX PRO 3310 SINGLE ACTION SPRING HINGES



- Standard weight, full mortise
- 3 knuckle, 2 anti-friction nylon washers
- Steel with steel components
- ANSI/BHMA A156.7 template hole pattern
- cULus listed¹

- Non-handed
- Adjustable spring tension (tool included)
- Wood and/or undercut machine screws included

OPTIONS

3311: Radius corners: 1/4" (6.4 mm)

NOTE: For best results, use with DOREX PRO ball bearing hinges of the same size.

(1) Minimum of two (2) 3310 hinges per labelled fire door



3310	C15	454
MODEL	FINISH	SIZE

SIZE	INCHES	MM	GAUGE	FIRE RATING*	HOLES	SCREWS INCLUDED MACHINE	WOOD	QTY ¹
3535	3 1/2 x 3 1/2	88.9 x 88.9	0.125	90 min.	6	—	#9 x 3/4	2 / 40
44	4 x 4	101.6 x 101.6	0.125	90 min.	8	—	#9 x 3/4	2 / 40
44	4 x 4 (RC)	101.6 x 101.6 (RC)	0.125	90 min.	8	—	#10 x 3/4	2 / 40
454	4 1/2 x 4	114.3 x 101.6	0.134	180 min.	8	#12-24 x 1/2	#12 x 1 1/4	2 / 40

(*) MAX. FIRE RATING BASED ON NFPA80 GUIDELINES. (1) 2/40 : QUANTITY PER BOX / QUANTITY PER CASE. HINGES NOT SOLD INDIVIDUALLY. (RC) RADIUS CORNERS.

C15	C26D	C3	C3M	C5
SATIN NICKEL	SATIN CHROME	POLISHED BRASS	MIRROR POLISH BRASS	ANTIQUÉ BRASS

OTHER FINISHES AVAILABLE, MAY REQUIRE SPECIAL ORDER AND/OR ADDITIONAL LEAD TIME.

CAUTION: Misaligned and/or twisted door frames or doors, door bottoms or gasketing for smoke, sound, weather, air pressure differences or improper latch installation/adjustment may prevent door from latching. Some installations may require additional spring hinges.

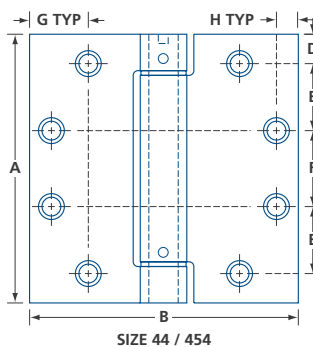
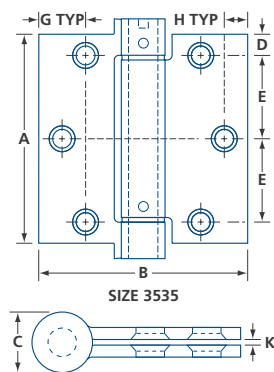

SIZE	MAXIMUM DOOR WT. ¹	SPRING HINGES	BUTT HINGES ²
3535	50 (22.7)	1	2
	70 (31.8)	2	1
	80 (36.3)	3	—
44	60 (27.2)	1	2
	85 (38.6)	2	1
	100 (45.5)	3	—
454	70 (31.8)	1	2
	90 (40.9)	2	1
	120 (54.5)	3	—

(1) LB(KG) MAXIMUM SIZE: 48 X 90" (1219 X 2286 MM). MAX. FIRE DOOR SIZE: 36 X 84" (914 X 2134 MM).

(2) FOR BEST RESULTS, USE DOREX PRO179 HINGES OF THE SAME SIZE.

MODEL	A	B	C	D	E	F	G	K
3310 3535	3 1/2 (88.9)	3 1/2 (88.9)	1 1/16 (17.5)	23/64 (9.1)	125/64 (35.4)	—	1 1/16 (17.5)	1/16 (1.6)
3310/11 44	4 (101.6)	4 (101.6)	1 1/16 (17.5)	1/2 (12.7)	1 (25.5)	31/32 (24.6)	3/4 (19.1)	1/16 (1.6)
3310 454	4 1/2 (114.3)	4 (101.6)	25/32 (19.6)	1/2 (12.7)	1 1/8 (28.6)	1 15/64 (31)	1 (25.4)	1/16 (1.6)

DIMENSIONS IN INCHES (MILLIMETRES) AS PER ANSI A156.7

COMMERCIAL HINGES

REINFORCEMENT & FILLER PLATES

1310 SINGLE ACTION SPRING HINGES



- Standard weight, full mortise
- 3 knuckle, 2 anti-friction nylon washers
- Steel with steel components
- ANSI/BHMA A156.7 template hole pattern
- cULus listed¹
- Non-handed
- Adjustable spring tension (tool included)
- Wood and/or undercut machine screws included

NOTE: For best results, use with ball bearing hinges of the same size.

(1) Minimum of two (2) 1310 hinges per labelled fire door



1310	C15	454
MODEL	FINISH	SIZE

SIZE	INCHES	MM	GAUGE	FIRE RATING*	HOLES	SCREWS INCLUDED MACHINE	WOOD	QTY ¹
454	4 1/2 x 4	114.3 x 101.6	0.134	180 min.	8	#12-24 x 1/2	#12 x 1 1/4	2 / 48

(*) MAX. FIRE RATING BASED ON NFPA 80 GUIDELINES. (1) 2/48 : QUANTITY PER BOX / QUANTITY PER CASE. HINGES NOT SOLD INDIVIDUALLY.

C15	C1D	C26D
SATIN NICKEL	MATTE BLACK	SATIN CHROME

OTHER FINISHES AVAILABLE, MAY REQUIRE SPECIAL ORDER AND/OR ADDITIONAL LEAD TIME.

CAUTION: Misaligned and/or twisted door frames or doors, door bottoms or gasketing for smoke, sound, weather, air pressure differences or improper latch installation/adjustment may prevent door from latching. Some installations may require additional spring hinges.

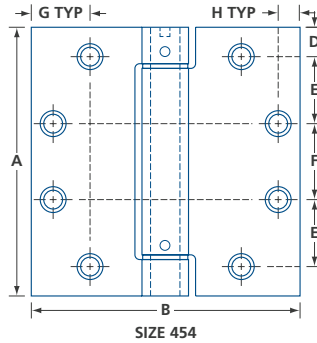

SIZE	MAXIMUM DOOR WT. ¹	SPRING HINGES	BUTT HINGES ²
454	110 (50.0)	2	1
	120 (54.5)	3	—

(1) LB(KG) MAXIMUM SIZE: 48 X 90" (1219 X 2286 MM).

MAX. FIRE DOOR SIZE: 36 X 84" (914 X 2134 MM).

(2) FOR BEST RESULTS, USE BALL BEARING HINGES OF THE SAME SIZE.

MODEL	A	B	C	D	E	F	G	H	K
1310 454	4 1/2 (114.3)	4 (101.6)	19/32 (15.2)	1/2 (12.7)	1 1/8 (28.6)	1 15/64 (31)	1 (25.4)	3/8 (9.5)	1/16 (1.6)

DIMENSIONS IN INCHES (MILLIMETRES) AS PER ANSI A156.7

COMMERCIAL HINGES

SPRING HINGES



4300 SERIES SINGLE ACTING TEMPLATE SPRING HINGES



4310
Square Corner

- BHMA Certified, Grade 1
- ANSI/BHMA A156.7 template hole pattern
- cULus listed for fire door application

- Non-handed
- Steel with steel components
- Self-lubricating bearings
- Adjustable spring tension
- Aligns with full mortise BOMMER hinges of the same size

Minimum 2 hinges per door.

4310	C26D	454
MODEL	FINISH	SIZE

C15	C26D	C32D
SATIN NICKEL	SATIN CHROME	SATIN STAINLESS STEEL

OTHER FINISHES AVAILABLE. SOME SIZE/FINISH/OPTION COMBINATIONS MAY REQUIRE SPECIAL ORDER AND/OR ADDITIONAL LEAD TIME.

Available in a variety of architectural finishes, models and sizes – please contact to order or visit www.bommer.com for details



3000 SERIES DOUBLE ACTING SPRING HINGES



3029/3029A
Full Mortise

- Non handed
- Steel with steel components
- Adjustable spring tension
- Does not align with standard full mortise hinges
- Do not use on door with bevelled hinge edge
- ANSI/BHMA A156.7 template models available
- Box clamp flanges are NOT ADJUSTABLE, available for fixed door thicknesses only

Available in a variety of architectural finishes, models and sizes – please contact to order or visit www.bommer.com for details

COMMERCIAL HINGES

REINFORCEMENT & FILLER PLATES

DOREX UNIVERSAL REPLACEMENT HINGE

1020



- Non handed
- Surface mounted
- Anti-friction ball bearings for smooth pin rotation
- Precision machined, extruded aluminum
- For aluminum frame doors up to 300 lbs (136 kg)
- $\frac{1}{8}$ " (3 mm) Vertical door adjustment
- Can accommodate $\frac{1}{8}$ " (3 mm) recessed doors
- Easy installation

INCLUDES

- (2) Hinges
- (2) #1020S $\frac{1}{8}$ " (3 mm) shim plates (matching finish)
- (4) Adhesive cover strips (matching finish)
- (1) Hex key
- (12) Tamper resistant fasteners

#1020SC Shim plate pairs available separately.

1020	C28
MODEL	FINISH

MODEL	HINGE SIZE INCHES	MM	GAUGE	HOLES	QTY ¹
1020	3 1/4 x 5	82.6 x 127	0.218	6	8 / 32

(1) 8 / 32 : QUANTITY PER INNER CARTON / QUANTITY PER CASE. HINGES SOLD IN PAIRS, NOT SOLD INDIVIDUALLY.

C20D	C28
DARK BRONZE	ALUMINUM

OTHER FINISHES AVAILABLE, MAY REQUIRE SPECIAL ORDER AND/OR ADDITIONAL LEAD TIME.

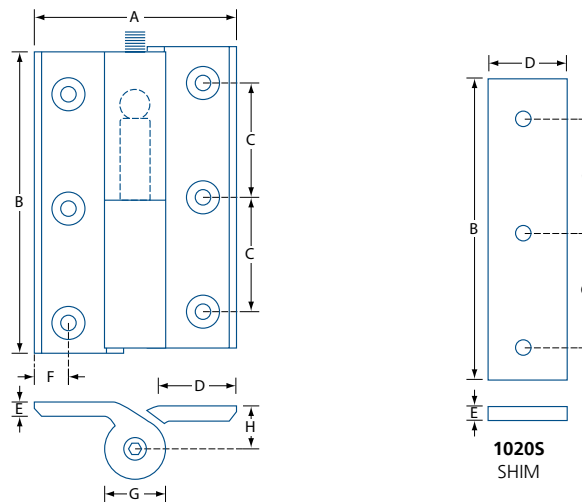

MODEL	A	B	C	D	E	F	G	H
1020	3 1/4 (82.6)	5 (127)	2 (50.8)	1 (25.4)	7/32 (5.6)	9/16 (14)	1 (25.4)	3/4 (19)
1020S	—	5 (127)	2 (50.8)	1 (25.4)	1/8 (3.2)	7/32 (5.6)	1 (25.4)	—

IN (MM)

RESIDENTIAL HINGES

BALL BEARING HINGES

B848 SERIES BALL BEARING HINGES

B848



B848 C15 33
3 x 3"
Square corners

- For wood door and frame applications
- Full mortise
- 5 knuckles, 2 ball bearings
- Steel hinge and pin
- Non-rising, removable pin
- Sold in boxed pairs
- Wood screws included

OPTIONS

-A: ¼" Radius corners (3535 only)



B848 C15 3535
3 ½ x 3 ½"
Square corners



B848 C15 3535 -A
3 ½ x 3 ½"
¼" (6.4 mm)
Radius Corners

B848	C15	3535	-A
MODEL	FINISH	SIZE	OPTION

SIZE	INCHES	MM	FINISH ¹	HOLES	WOOD SCREWS	QTY ²
33	3 x 3	76 x 76	C15	6	#8 x ¾"	2/100
3535	3 ½ x 3 ½	88.9 x 88.9	C15	6	#8 x ¾"	2/100

(1) OTHER FINISHES AVAILABLE (2) 2/100 : QUANTITY PER BOX / QUANTITY PER CASE. HINGES NOT SOLD INDIVIDUALLY.

BB2500 SERIES BALL BEARING HINGES

BB2589, BB2590



BB2589
3 ½ x 3 ½"
Square Corner

- For wood door and frame applications
- Full mortise
- 5 knuckles, 2 ball bearings
- Steel hinge and pin
- Non-rising, removable pin
- Sold in boxed pairs
- Wood screws included



BB2590
3 ½ x 3 ½"
¼" (6.4 mm)
Radius Corners

BB2589	C15	33	P
MODEL	FINISH	SIZE	

BB2589

SIZE	INCHES	MM	FINISH ¹	HOLES	SCREWS	/CASE ²
33	3 x 3	76.2 x 76.2	C15	6	#9 x ¾"	2/100
3535	3 ½ x 3 ½	88.9 x 88.9	C15	6	#9 x ¾"	2/100

(1) OTHER FINISHES AVAILABLE (2) 2/100 : QUANTITY PER BOX / QUANTITY PER CASE. HINGES NOT SOLD INDIVIDUALLY.

BB2590

SIZE	INCHES	MM	FINISH ¹	HOLES	SCREWS	/CASE ²
3535	3 ½ x 3 ½	88.9 x 88.9	C15, C26D	6	#9 x ¾"	2/100

(1) OTHER FINISHES AVAILABLE (2) 2/100 : QUANTITY PER BOX / QUANTITY PER CASE. HINGES NOT SOLD INDIVIDUALLY.

RESIDENTIAL HINGES

PLAIN BEARING HINGES

2500 SERIES RESIDENTIAL STEEL HINGES

2589, 2590, 2591



2589
Square Corner

- For wood door and frame applications
- Full mortise
- 5 knuckles, plain bearing
- Steel hinge and removable pin
- Unassembled hinge by default
- Wood screws included
- Packaged in bulk

OPTIONS

- A: Assembled hinge, with screws
- P: Boxed pair (assembled), with screws



2590
1/4" (6.4 mm)
Radius Corners

2589	C15	3535	A
MODEL	FINISH	SIZE	OPTION*
(*) LEAVE BLANK FOR UNASSEMBLED			

2589

SIZE	INCHES	MM	FINISH ¹	HOLES	SCREWS	/CASE ²
33	3 x 3	76.2 x 76.2	C15, C19, C2G	6	#9 x 3/4	100
3535	3 1/2 x 3 1/2	88.9 x 88.9	C15, C2G	6	#9 x 3/4	100
44	4 x 4	101.6 x 101.6	C2G	6	#9 x 3/4	100

(1) OTHER FINISHES AVAILABLE (2) 50 BOXED PAIRS OR 100 INDIVIDUAL HINGES.

2590

SIZE	INCHES	MM	FINISH ¹	HOLES	SCREWS	/CASE ²
33	3 x 3	76.2 x 76.2	C11P, C15, C15A, C19	6	#9 x 3/4	100
3535	3 1/2 x 3 1/2	88.9 x 88.9	C15, C26, C26D, C2G	6	#9 x 3/4	100

(1) OTHER FINISHES AVAILABLE (2) 50 BOXED PAIRS OR 100 INDIVIDUAL HINGES.



2591
3/8" (16 mm)
Radius Corners

2591

SIZE	INCHES	MM	FINISH ¹	HOLES	SCREWS	/CASE ²
33	3 x 3	76.2 x 76.2	C11P, C15, C15A, C19, C26, C26D, C2G, C3	6	#9 x 3/4	100
3535	3 1/2 x 3 1/2	88.9 x 88.9	C15, C19, C26D, C2G	6	#9 x 3/4	100

(1) OTHER FINISHES AVAILABLE (2) 50 BOXED PAIRS OR 100 INDIVIDUAL HINGES.

BULK ORDERS

Bulk or volume orders are available for original equipment manufacturers (OEM), project builds, and other contractors.

Custom options and non-stock finishes may require additional lead time or minimum quantity orders.

Please contact for details, including options, available sizes and finishes.

Common options include:

- Delivery without screws
- Delivery in split packaging
- Specific non-stock finish



RESIDENTIAL HINGES

PLAIN BEARING HINGES

DOREX STAINLESS STEEL HINGES

84



- For wood door and frame applications
- Full mortise
- 5 knuckles, plain bearing
- Stainless steel
- Removable pin
- Sold in boxed pairs
- Wood screws included

84	C32D	33
MODEL	FINISH	SIZE

SIZE	INCHES	MM	GUAGE	FINISH ¹	HOLES	SCREWS	QTY ²
33	3 x 3	76.2 x 76.2	2.3	C32D	6	#8 x 3/4	2 / 100
3535	3 1/2 x 3 1/2	88.9 x 88.9	2.3	C32D	6	#9 x 1	2 / 60

(1) OTHER FINISHES AVAILABLE (2) 2/100 : QUANTITY PER BOX / QUANTITY PER CASE. HINGES NOT SOLD INDIVIDUALLY.

RESIDENTIAL HINGES

ASSORTED HINGES

2600 SERIES DECORATIVE HINGES

2698



2698
 $\frac{3}{8}$ " (16 mm)
 Radius Corners
 Steeple Tip

- For wood door and frame applications
- Full mortise
- 5 knuckles, plain bearing
- Steel hinge and pin
- Sold in assembled pairs, boxed
- Wood screws included

2698	C19	33
MODEL	FINISH	SIZE

SIZE	INCHES	MM	FINISH ¹	HOLES	SCREWS	/CASE ²
33	3 x 3	76.2 x 76.2	C19	6	#9 x $\frac{3}{4}$	2/100

(1) OTHER FINISHES AVAILABLE (2) 2/100 : QUANTITY PER BOX / QUANTITY PER CASE. HINGES NOT SOLD INDIVIDUALLY.

LIGHT DUTY DOUBLE ACTING SPRING HINGE

9290



- For light duty residential applications
- Non handed
- Adjustable spring tension
- Does not align with standard full mortise hinges
- Do not use on door with bevelled hinge edge
- Sold in pairs
- Required fasteners included

9290	SDN	3
MODEL	FINISH	SIZE

SIZE	A	B	FINISH	DOOR THICKNESS	QTY ¹
3	3 (76)	$2\frac{23}{32}$ (69.4)	SDB, SDN	$1\frac{1}{4}$ (31.8)	2
4	4 (102)	$3\frac{25}{32}$ (95.8)	KJ, SDN	$1\frac{1}{4}$ (31.8)	2
5	5 (127)	$4\frac{5}{8}$ (117.4)	KJ, SDB, SDN	$1\frac{1}{2}$ (38.1)	2
6	6 (152)	$5\frac{9}{16}$ (141.4)	KJ, SDB, SDN	$1\frac{7}{8}$ (48.6)	2

IN (MM) (1) SOLD IN PAIRS. NOT SOLD INDIVIDUALLY.

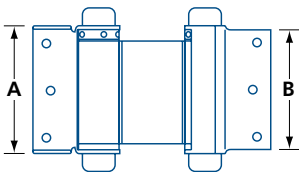

RESIDENTIAL HINGES

SCREEN DOOR SPRINGS



HALF SURFACE SCREEN DOOR SPRING HINGE

2930

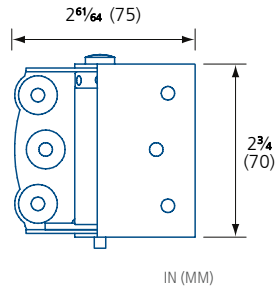

- Non-handed
- Steel hinge with loose pin
- Half surface (full surface model available)
- Available with reversible spring
- Adjustable spring tension
- Mounting hardware included

Available in a variety of architectural finishes and models – please contact to order or visit www.bommer.com for details

2930	C2G
MODEL	FINISH



FULL SURFACE SCREEN DOOR SPRING HINGE – ADJUSTABLE

2980

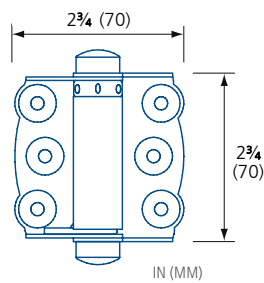
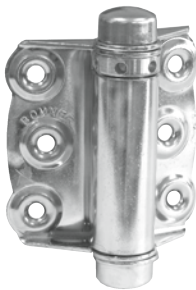

- Non-handed
- Steel hinge with button tip
- Full surface (half surface model available)
- Adjustable spring tension
- Mounting hardware included

Available in a variety of architectural finishes and models – please contact to order or visit www.bommer.com for details

2980	C2G
MODEL	FINISH

FULL SURFACE SCREEN DOOR SPRING HINGE

960

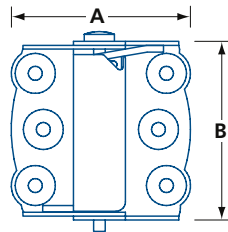

- Non-handed
- Steel hinge with fixed pin
- Full Surface
- Fixed spring tension (not adjustable)
- Mounting hardware included

960	ZP
MODEL	FINISH

MODEL	A	B	FINISH	/BOX	/CASE
960	3 (76)	2 ²³ / ₃₂ (69.4)	ZP	—	200
2960	4 (102)	3 ²⁵ / ₃₂ (95.8)	C2G	2	40



IN (MM)

RESIDENTIAL HINGES

DOOR SPRING



AUXILIARY DOOR SPRING

2430, 2520



- Non-handed
- Economical closing device
- Adjustable spring tension
- Do not apply more than three (3) hole tension
- Maximum capacity: 50 lbs (22.7 kg)
- Mounting hardware included

Available in a variety of architectural finishes and models – please contact to order or visit www.bommer.com for details

2430	C1B
MODEL	FINISH



CONTINUOUS GEARED HINGES

FULL CONCEALED / HALF SURFACE

ABH FULL CONCEALED ALUMINUM GEARED HINGES

ABH-A110HD

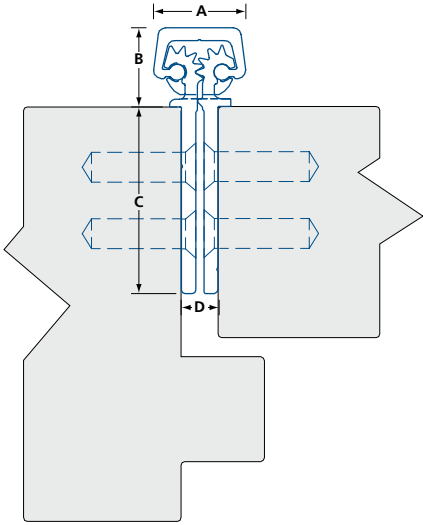

- Certified ANSI/BHMA A156.26, Grade 1
- cULus fire rated, 90/60 min.*
- Full mortise, heavy duty
- No door inset, flush mount
- 48" (1219 mm) door width maximum
- 450 lbs (204 kg) door weight maximum
- Undercut Tek screws included
- Power transfer ready model available (PT)
- 1000 lbs (454 kg) high capacity model available for lead lined doors

*Metal door / wood door

Available in a variety of finishes, models, options, and lengths. Please contact us to order. Visit www.abhmfg.com for product or warranty details (coverage may vary by country).

ABH-A110	HD	C	095	-PT
MODEL	TYPE	FINISH	LENGTH	OPTION
HD: HEAVY DUTY LL: HIGH CAPACITY PT: POWER TRANSFER				

STANDARD LENGTHS

Inch: 79 / 83 / 85 / 95 / 120
MM: 2006 / 2108 / 2159 / 2413 / 3048

FINISHES

B-Black anodized
C-Clear anodized
D-Dark bronze anodized

MODEL	A	B	C	D	E	CAPACITY ¹
ABH-A110HD	$\frac{25}{32}$ (19.8)	$\frac{21}{32}$ (16.7)	$\frac{19}{16}$ (39.7)	$\frac{5}{16}$ (7.9)	—	450 (204)

IN(MM) (1) LBS (KG) - HIGH CAPACITY MODEL AVAILABLE

ABH HALF SURFACE ALUMINUM GEARED HINGES

ABH-A530HD

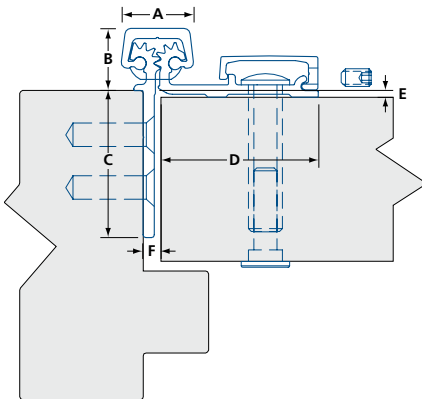

- Certified ANSI/BHMA A156.26, Grade 1
- cULus fire rated, 90/60 min.*
- Half surface, heavy duty
- $\frac{3}{32}$ " (2.4 mm) door inset
- 48" (1219 mm) door width maximum
- 450 lbs (204 kg) door weight maximum
- Undercut Tek screws and sex-nut bolts included

*Metal door / wood door

Available in a variety of finishes, models, options, and lengths. Please contact us to order. Visit www.abhmfg.com for product or warranty details (coverage may vary by country).

ABH-A530	HD	C	083
MODEL	TYPE	FINISH	LENGTH
HD: HEAVY DUTY LL: HIGH CAPACITY PT: POWER TRANSFER			

STANDARD LENGTHS

Inch: 79 / 83 / 85 / 95 / 120
MM: 2006 / 2108 / 2159 / 2413 / 3048

FINISHES

B-Black anodized
C-Clear anodized
D-Dark bronze anodized

MODEL	A	B	C	D	E ¹	F	CAPACITY ²
ABH-A530HD	$\frac{25}{32}$ (19.8)	$\frac{11}{16}$ (17.5)	$\frac{19}{16}$ (39.7)	$\frac{11}{16}$ (42.9)	$\frac{3}{32}$ (2.4)	$\frac{13}{64}$ (5.1)	450 (204)

IN(MM) (1) DOOR INSET (2) LBS (KG)

CONTINUOUS GEARED HINGES

FULL SURFACE

ABH FULL SURFACE ALUMINUM GEARED HINGES (SWING CLEAR)

ABH-A210HD

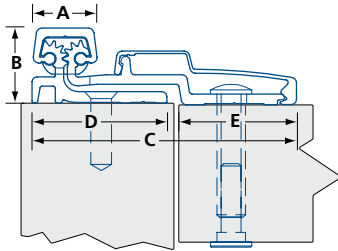

- Certified ANSI/BHMA A156.26, Grade 1
- cULus fire rated, 90/60 min.*
- Full surface, heavy duty
- Swing clear application
- No door inset, flush mount
- 48" (1219mm) door width maximum
- 450 lbs (204 kg) door weight maximum
- Undercut Tek screws and sex-nut bolts included

STANDARD LENGTHS

Inch: 79 / 83 / 85 / 95 / 120
MM: 2006 / 2108 / 2159 / 2413 / 3048

FINISHES

B–Black anodized
C–Clear anodized
D–Dark bronze anodized

*Metal door / wood door

Available in a variety of finishes, models, options, and lengths. Please contact us to order. Visit www.abhmfg.com for product or warranty details (coverage may vary by country).

ABH-A210	HD	C	083
MODEL	TYPE	FINISH	LENGTH

MODEL	A	B	C	D	E	CAPACITY ¹
ABH-A210HD	$\frac{25}{32}$ (19.8)	$\frac{29}{32}$ (23)	$3 \frac{5}{32}$ (80.6)	$1 \frac{5}{8}$ (41.3)	$1 \frac{35}{64}$ (39.3)	450 (204)

(1) LBS (KG) OTHER HIGH CAPACITY MODELS AVAILABLE

ABH FULL SURFACE ALUMINUM GEARED HINGES - CENTER PIVOT

ABH-A570HD

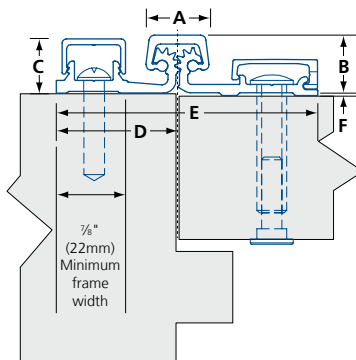

- Certified ANSI/BHMA A156.26, Grade 1
- cULus fire rated, 90/60 min.*
- Full surface, heavy duty
- For narrow-faced frames, $\frac{7}{8}$ " (22mm) minimum frame width
- $\frac{1}{16}$ " (1.6 mm) door inset
- 48" (1219 mm) door width maximum
- 450 lbs (204 kg) door weight maximum
- Undercut Tek screws and sex-nut bolts included

STANDARD LENGTHS

Inch: 79 / 83 / 85 / 95 / 120
MM: 2006 / 2108 / 2159 / 2413 / 3048

FINISHES

B–Black anodized
C–Clear anodized
D–Dark bronze anodized

*Metal door / wood door

Available in a variety of finishes, models, options, and lengths. Please contact us to order. Visit www.abhmfg.com for product or warranty details (coverage may vary by country).

ABH-A570	HD	C	083
MODEL	TYPE	FINISH	LENGTH

MODEL	A	B	C	D	E ¹	F	CAPACITY ²
ABH-A570HD	$\frac{23}{32}$ (18.3)	$\frac{23}{32}$ (18.3)	$2 \frac{1}{32}$ (16.7)	$1 \frac{15}{32}$ (37.3)	$3 \frac{3}{16}$ (81)	$\frac{1}{16}$ (1.6)	450 (204)

IN(MM) (1) DOOR INSET (2) LBS (KG)



CONTINUOUS GEARED HINGES

FULL CONCEALED

DOREX FULL CONCEALED ALUMINUM GEARED HINGE

CGHFM HD

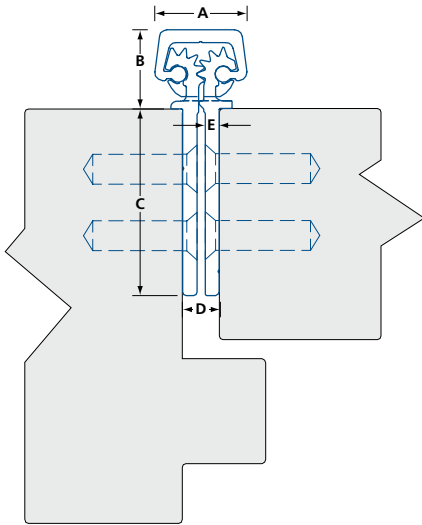

- Conforms to ANSI/BHMA A156.26 Grade 1
- 10 Year limited warranty
- Extruded 6063 aluminum alloy continuous geared hinges with self-lubricating thrust bearings
- Full concealed mounting (no mortise required), heavy duty
- No door inset, flush mount
- For doors 1 3/4" – 2 1/4" (44.5 – 57 mm) thick, up to 48" (1219 mm) wide
- 400 lbs (182 kg) door weight maximum
- Doors heavier than 200 lbs (90.7 kg) require door and frame reinforcement
- Mounting hardware included for metal door and frame:
 - » #12-24x5/8" (16 mm) self-drilling/tapping TEK screws (undercut)

STANDARD LENGTHS

Inch: 83 / 95 / 120
MM: 2108 / 2413 / 3048

FINISHES

AL–Aluminum anodized
DU–Dark bronze anodized
MB–Matte black anodized

CGH	FM	120	HD	-	AL
MODEL	TYPE	LENGTH	DUTY		FINSH
HD: HEAVY DUTY					

MODEL	A	B	C	D	E	CAPACITY
CGHFM HD	25/32 (20)	3/4 (19)	1 9/16 (40)	5/16 (8)	1/8 (3)	400 (182)

IN(MM) LBS (KG)

CONTINUOUS GEARED HINGES

FULL SURFACE

DOREX® FULL SURFACE ALUMINUM GEARED HINGE (SWING CLEAR)

CGHFSSC HD

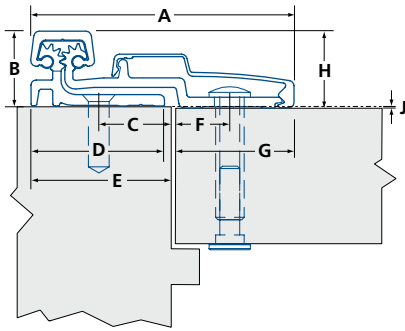

- Conforms to ANSI/BHMA A156.26 Grade 1
- 10 Year limited warranty
- Extruded 6063 aluminum alloy continuous geared hinges with self-lubricating thrust bearings
- Full surface, heavy duty
- Swing clear application
- 1/32" (0.8 mm) door inset
- For doors 1 3/4" – 2 1/4" (44.5 – 57 mm) thick, up to 48" (1219 mm) wide
- For door frames at least 1 3/4" (44 mm) wide when aligned with door gap
- 400 lbs (182 kg) door weight maximum
- Doors heavier than 200 lbs (90.7 kg) require door and frame reinforcement
- Mounting hardware included for metal door and frame:
 - » #12-24x5/8" (16 mm) self-drilling/tapping TEK screws (undercut)
 - » 1/4-20 Sex bolt and machine screws for doors up to 2 1/4" (57 mm) thick

STANDARD LENGTHS

Inch: 83 / 95 / 120
MM: 2108 / 2413 / 3048

FINISHES

AL–Aluminum anodized
DU–Dark bronze anodized
MB–Matte black anodized

CGH	FSSC	120	HD	–	AL
MODEL	TYPE	LENGTH	DUTY		FINISH

HD: HEAVY DUTY

MODEL	A	B	C	D	E	F	G	H	J'	CAPACITY ²
CGHFSSC HD	3.18 (81)	0.91 (23)	0.72 (18)	1.37 (35)	1.73 (44)	0.67 (17)	1.27 (32)	0.94 (24)	0.03 (0.8)	400 (182)

IN(MM) (1) DOOR INSET (2) LBS (KG)

DOREX® FULL SURFACE ALUMINUM GEARED HINGE (CENTER PIVOT)

CGHFS HD

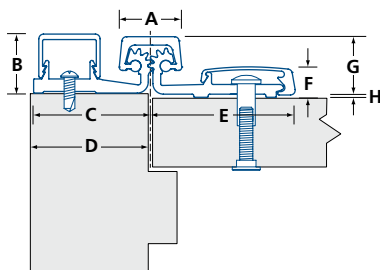

- Conforms to ANSI/BHMA A156.26 Grade 1
- 10 Year limited warranty
- Extruded 6063 aluminum alloy continuous geared hinges with self-lubricating thrust bearings
- Full surface, heavy duty
- 1/16" (1.6 mm) door inset
- For doors 1 3/4" – 2 1/4" (44.5 – 57 mm) thick, up to 48" (1219 mm) wide
- For narrow-faced door frames at least 1 1/2" (38 mm) when aligned with door gap; 7/8" (22 mm) when offset
- 400 lbs (182 kg) door weight maximum
- Doors heavier than 200 lbs (90.7 kg) require door and frame reinforcement
- Mounting hardware included for metal door and frame:
 - » #12-24x5/8" self-drilling/tapping TEK screws (undercut)
 - » 1/4-20 Sex bolt and machine screws for doors up to 2 1/4" (57 mm) thick

STANDARD LENGTHS

Inch: 83 / 95 / 120
MM: 2108 / 2413 / 3048

FINISHES

AL–Aluminum anodized
DU–Dark bronze anodized
MB–Matte black anodized

REPLACEMENT SNAP COVER

Door Leaf

CGH-COVER95D-AL 95"
CGH-COVER95D-DU 95"
CGH-COVER95D-MB 95"

Frame Leaf

CGH-COVER-AL 83"
CGH-COVER-DU 83"
CGH-COVER95F-AL 95"
CGH-COVER95F-DU 95"
CGH-COVER95F-MB 95"

CGH	FS	120	HD	–	AL
MODEL	TYPE	LENGTH	DUTY		FINISH

HD: HEAVY DUTY

MODEL	A	B	C	D	E	F	G	H'	CAPACITY ²
CGHFS HD	25/32 (20)	3/4 (19)	1 15/32 (37)	1 1/2 (38)	1 7/8 (48)	3/8 (9.5)	3/4 (19)	1/16 (1.6)	400 (182)

IN(MM) (1) DOOR INSET (2) LBS (KG)



PIVOTS

OFFSET

DOREX J SERIES 3/4" OFFSET PIVOT SETS

J25, J26, J28, J31

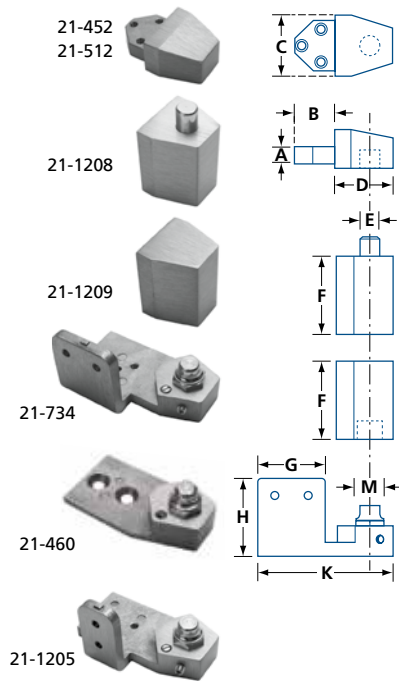

- For aluminum door and frame
 - Handed or non-handed – see chart
 - Capacity up to 125 lbs (57 kg)
 - 1/8" (3 mm) vertical adjustment range
 - Aluminum die-cast housing
 - All-weather acrylic coating
 - Oilite bronze bushing in frame top unit
 - Spring loaded pivot in door top unit
 - Full race ball bearing in door bottom unit
 - Case-hardened steel stub in frame bottom unit
- Modular design, all set components available individually – see chart

J2501	AL
SET	FINISH

J25 / J26 / J28 / J31

TYPE	SET	HAND	FINISH	FRAME TOP	DOOR TOP	DOOR BOTTOM	FRAME BOTTOM
Flush, jamb mount	J2501	RIGHT	AL	21-452	21-1208	21-1209	21-734
	J2502	LEFT	AL				21-738
1/8" Recess, jamb mount	J2601	RIGHT	AL	21-512	21-1208	21-1209	21-734
	J2602	LEFT	AL				21-738
1/8" Recess, non-handed	J2800	—	AL	21-512	21-1208	21-1209	21-460
1/8" Recess, narrow	J3101	RIGHT	AL	21-512	21-1208	21-1209	21-1205
	J3202	LEFT	AL				21-1204

	A	B	C	D	E	F	G	H	K	M
J25	13/32 (10)	29/32 (23)	1 3/8 (34.8)	1 9/32 (32.4)	7/16 (11)	1 3/4 (44.4)	1 1/2 (38.1)	1 3/4 (44.3)	3 1/32 (77)	1 1/16 (17.2)
	13/32 (10)	29/32 (23)	1 3/8 (34.8)	1 9/32 (32.4)	7/16 (11)	1 3/4 (44.4)	1 1/2 (38.1)	1 3/4 (44.3)	3 1/32 (77)	1 1/16 (17.2)
J26	13/32 (10)	29/32 (23)	1 3/8 (34.8)	1 9/32 (32.4)	7/16 (11)	1 3/4 (44.4)	1 1/2 (38.1)	1 3/4 (44.3)	3 1/32 (77)	1 1/16 (17.2)
	13/32 (10)	29/32 (23)	1 3/8 (34.8)	1 9/32 (32.4)	7/16 (11)	1 3/4 (44.4)	—	—	3 1/32 (77)	1 1/16 (17.2)
J28	13/32 (10)	29/32 (23)	1 3/8 (34.8)	1 9/32 (32.4)	7/16 (11)	1 3/4 (44.4)	—	—	3 1/32 (77)	1 1/16 (17.2)
	13/32 (10)	29/32 (23)	1 3/8 (34.8)	1 9/32 (32.4)	7/16 (11)	1 3/4 (44.4)	7/8 (22.2)	1 3/4 (44.3)	3 1/32 (77)	1 1/16 (17.2)

IN(MM)

PIVOTS

OFFSET

ABH 3/4" OFFSET PIVOT SET – JAMB MOUNT

ABH-0117.25



0180

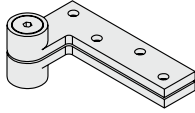

0117.25

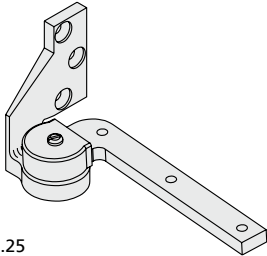

- Handed - indicate handing
- Maximum door width 42" (1066 mm) - interior doors only
- Maximum door load 250 lbs (113 kg)
- UL listed for use on 3-hour fire rated doors
- Conforms to ANSI C07162/3530A (modified)
- Heavy duty bearings
- Stainless steel base material
- Top pivot (#0180), header mount
- Bottom pivot (#0117.25), jamb mount
- Extended spindles available (special order)
- Use with ABH-019 intermediate pivot

Available in a variety of finishes, models, and options. Please contact us to order.
Visit www.abhmfg.com for product or warranty details (coverage may vary by country).

ABH-0117.25	-32D	-RH
MODEL	FINISH	HAND

LH : LEFT HAND RH : RIGHT HAND

ABH 3/4" OFFSET PIVOT SET

ABH-0147



0180

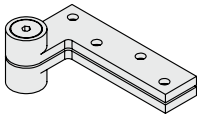

0147

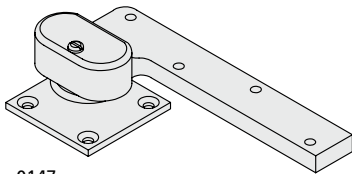

- Handed - indicate handing
- Maximum door load 600 lbs (272 kg)
- Maximum door width 48" (1219 mm); 36" (914 mm) for exterior doors
- UL listed for use on 3-hour fire rated doors
- Conforms to ANSI C07162/3530A (modified)
- Heavy duty bearings
- Stainless steel base material
- Top pivot (#0180), header mount
- Bottom pivot (#0147), floor mount
- Use with ABH-019 intermediate pivot

Available in a variety of finishes, models, and options. Please contact us to order.
Visit www.abhmfg.com for product or warranty details (coverage may vary by country).

ABH-0147	-32D	-RH
MODEL	FINISH	HAND

LH : LEFT HAND RH : RIGHT HAND



ABH CENTER HUNG PIVOT SET – JAMB MOUNT

ABH-0127

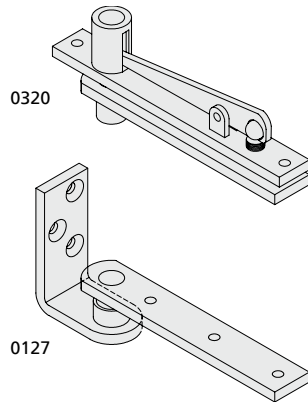

- Non handed
- Maximum door load 200 lbs (91 kg)
- Maximum door size 42 x 102" (1066 x 2591 mm) – interior doors only
- Conforms to ANSI C071042
- Heavy duty bearings
- Stainless steel base material
- Light duty top pivot (#0320), header mount
- Bottom pivot (#0127), jamb mount
- Extended spindles available (special order)
- Can be used with ABH Rescue Stops – please contact

Available in a variety of finishes, models, and options. Please contact us to order.
Visit www.abhmfg.com for product or warranty details (coverage may vary by country).

ABH-0127	- 32D
MODEL	FINISH

ABH CENTER HUNG PIVOT SET

ABH-0128

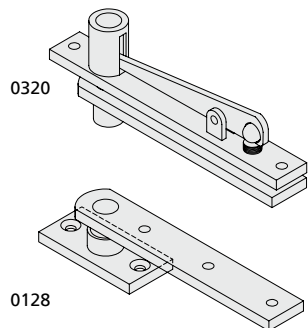

- Non-handed
- Maximum door load 250 lbs (113 kg)
- Maximum door size 42 x 102" (1066 x 2591 mm) – interior doors only
- Conforms to ANSI C07032/3530 (modified)
- Heavy duty bearings
- Stainless steel base material
- Light duty top pivot (#0320), header mount
- Bottom pivot (#0128), floor mount
- Extended spindles available (special order)
- Available with ABH CR4550 Rescue Strike – please contact

Available in a variety of finishes, models, and options. Please contact us to order.
Visit www.abhmfg.com for product or warranty details (coverage may vary by country).

ABH-0128	- 32D
MODEL	FINISH

PIVOTS

CENTER HUNG

ABH CENTER HUNG PIVOT SET – HEAVY DUTY

ABH-0370

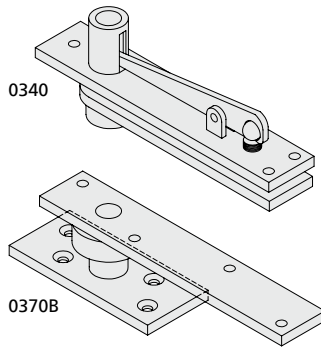

- Non-handed
- Maximum door load 500lbs (227kg)
- Maximum door size 44 x 102" (1118 x 2591 mm) – interior doors only
- Conforms to ANSI C07032
- Heavy duty bearings
- Stainless steel base material
- Heavy duty top pivot (#0340), header mount
- Bottom pivot (#0370B), floor mount
- Extended spindles available (special order)
- Top and bottom pivots available individually

Available in a variety of finishes, models, and options. Please contact us to order. Visit www.abhmfg.com for product or warranty details (coverage may vary by country).

ABH-0370	-32D
MODEL	FINISH

ABH REINFORCEMENT PIVOT – 3/4" OFFSET

ABH-0923

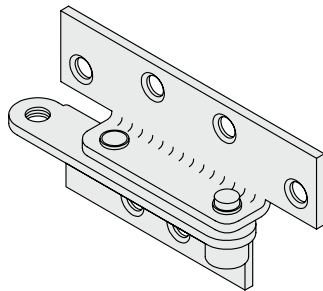

- Helps take load off failing top hinge and eliminate door sagging
- Surface mounts to the frame header and door face
- For 1/8" (3 mm) inset door with 3/4" (19 mm) offset
- Non-handed
- Maximum door load 300lbs (137 kg)
- Steel base material

Available in a variety of finishes, models, and options. Please contact us to order. Visit www.abhmfg.com for product or warranty details (coverage may vary by country).

ABH-0923	-32D
MODEL	FINISH

ABH INTERMEDIATE PIVOT – 3/4" OFFSET

ABH-019

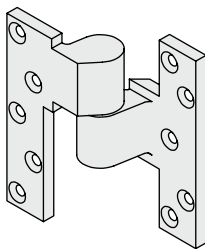

- Doors ranging from 60" tall should use one intermediate pivot. An additional intermediate pivot should be used for each additional 30" in door height. (ie, 90" tall door should use two intermediate pivots)
- Mortises into side jamb and hinge edge of door
- Handed
- For use with 3/4" (19 mm) offset pivot sets
- UL listed for use on 3-hour fire rated doors
- Helps maintain door alignment
- Heavy duty stainless steel needle bearings
- Stainless steel base material

Available in a variety of finishes, models, and options. Please contact us to order. Visit www.abhmfg.com for product or warranty details (coverage may vary by country).

ABH-019	LH	-32D
MODEL	HAND	FINISH

LH: LEFT HAND RH: RIGHT HAND



PIVOTS

SPRING & GRAVITY PIVOTS

7512P GRAVITY PIVOT



- Steel with nylon pivot bearing
- Non handed
- No spring, door self closing with door weight
- Double acting $\pm 90^\circ$, with $\frac{5}{8}$ " (16mm) door vertical rise
- Door thickness $\frac{7}{8}$ " to $1\frac{3}{4}$ " (22mm to 44mm)
- Maximum door width: 30" (762mm)
- Maximum door weight: 50 lbs (22.7kg)
- Surface mounted top & bottom door pivots
- Surface mounted mounting brackets
- Included #10 x 1" long mounting wood screws
- Zinc plated
- 7512P-H with hold-open feature

7512P	2G
MODEL	FINISH



7100 SERIES ADJUSTABLE SPRING PIVOTS



7112
Surface Pivot



7122
Mortise Pivot

- Non-handed
- For doors up to 36" (812mm) wide, $2\frac{1}{2}$ " (64mm) thick
- Maximum door weight: 75 lbs (34 kg)
- Cast steel with steel components
- Double acting
- Self-lubricating bearing
- Adjustable spring tension
- Flat door bracket for doors not less than 1" (25.4mm) thick
- Flat jamb bracket: $1\frac{1}{4}$ " (31.8mm) wide

7112	C2G
MODEL	FINISH

Available in a variety of architectural finishes, models and sizes – please contact to order or visit www.bommer.com for details

PIVOTS

SPRING & GRAVITY PIVOTS

7800 SERIES HORIZONTAL SPRING PIVOTS



- Non handed
- Light, medium and heavy duty models available
- Double acting
- Anti-friction bearing
- Maximum door width: 36" (914mm)
- Door thickness: 1 $\frac{3}{8}$ –1 $\frac{3}{4}$ " (35–44.5 mm)
- Hold open models available
- Top pivot and plate included

7801-C26D
SATIN CHROME

Light (35 lbs/16 kg)
Floor Mounted
Hold Open at 85°

7811P-H-19
MATTE BLACK

7811P-H-32D
SATIN STAINLESS STEEL

Medium (77 lbs/35 kg)
Floor Mounted
Hold Open at
88° and 116°

7813HD-C2G
ZINC PLATED

Heavy (150 lbs/68 kg)
Floor Mounted
No Hold Open

7811P-H - 32D	
MODEL	FINISH



PATCH FITTINGS

GLASS DOOR & PANELS

PF120 TOP DOOR PATCH FITTING

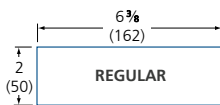

PF120TP1
Top Pivot



PF120TP2
Walking Pivot

- Recommended for use with top pivot #PF120TP1 or walking pivot #PF120TP2
- Also recommended for use with corner patch fitting #PF140 or wall mounted patch fitting #PF130
- Capacity: 220 lbs (100 kg)

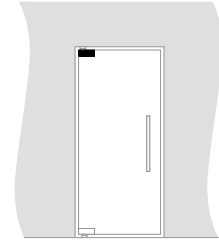

Maximum Door Size:
39 x 108 in (100 x 274 cm)

PF120	-	630
MODEL		FINISH

628	629	630	19
ALUMINUM	POLISHED STAINLESS STEEL	SATIN STAINLESS STEEL	MATTE BLACK

PF121 TOP DOOR PATCH FITTING – EXTENDED COVER

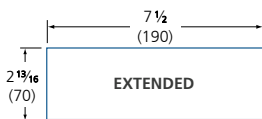

PF120TP1
Top Pivot



PF120TP2
Walking Pivot

- Recommended for use with #PF120TP1 top pivot or #PF120TP2 walking pivot
- Extended cover used to match #PF100DC/DCHO hydraulic patch fitting closer (see page 03.060)
- Capacity: 220 lbs (100 kg)

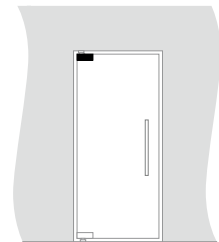

Maximum Door Size:
39 x 108 in (100 x 274 cm)

PF121	-	630
MODEL		FINISH

628	629	630	19
ALUMINUM	POLISHED STAINLESS STEEL	SATIN STAINLESS STEEL	MATTE BLACK

PATCH FITTINGS

GLASS DOOR & PANELS

PF150 TOP DOOR PATCH FITTING

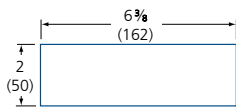

DOREX 30 Series
Door Closer

- Recommended for use with DOREX 30 concealed overhead door closer (see page 03.052)
- Capacity: 220 lbs (100 kg)

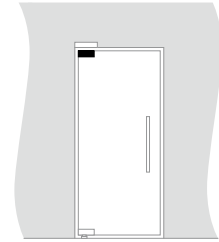

Maximum Door Size:
39 x 108 in (100 x 274 cm)

PF150	-	630
MODEL		FINISH

628	629	630	19*
ALUMINUM	POLISHED STAINLESS STEEL	SATIN STAINLESS STEEL	MATTE BLACK

(*) SPECIAL ORDER

PF110 BOTTOM DOOR PATCH FITTING

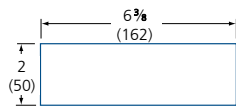

DOREX 40 Series
Door Closer



PF110BP1
Bottom Door Pivot

- Recommended for use with #PF110BP1 bottom door pivot or with DOREX 40 Series concealed floor closer (see page 03.054)
- Capacity: 220 lbs (100 kg)

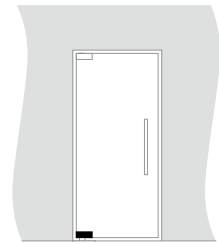

Maximum Door Size:
39 x 108 in (100 x 274 cm)

PF110	-	630
MODEL		FINISH

628	629	630	19*
ALUMINUM	POLISHED STAINLESS STEEL	SATIN STAINLESS STEEL	MATTE BLACK

(*) SPECIAL ORDER



PATCH FITTINGS

GLASS DOORS AND PANELS

PF160 TRANSOM CORNER PATCH FITTING WITH DOOR STOP



- For use with glass transom and sidelight
- For single glass door applications
- Capacity: 220 lbs (100 kg)

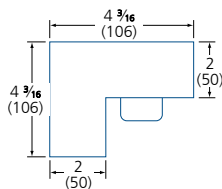
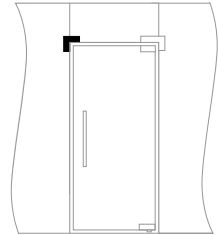

PF160	–	630
MODEL		FINISH

628	629	630	19*
ALUMINUM	POLISHED STAINLESS STEEL	SATIN STAINLESS STEEL	MATTE BLACK

(*) SPECIAL ORDER

PF165 TRANSOM CONNECTOR WITH DOOR STOP



- For use with glass transom
- For double glass door applications
- Capacity: 220 lbs (100 kg)

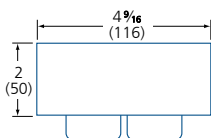
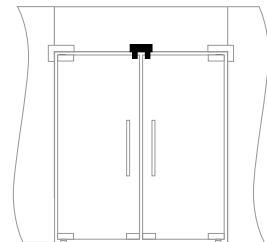

PF165	–	630
MODEL		FINISH

628	629	630	19*
ALUMINUM	POLISHED STAINLESS STEEL	SATIN STAINLESS STEEL	MATTE BLACK

(*) SPECIAL ORDER

PF165CM CEILING MOUNTED DOOR STOP



- Installed on ceiling or solid transom
- For single or double glass door applications
- Cast stainless steel
- Includes mounting screws and plastic anchors

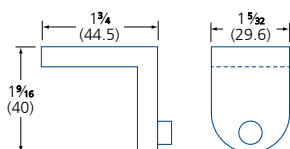
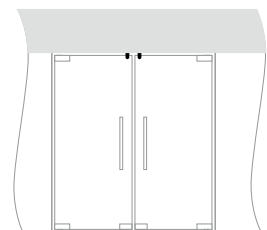

PF165CM	–	630
MODEL		FINISH

PATCH FITTINGS

GLASS DOOR & PANELS

PF140 TRANSOM CORNER PATCH FITTING WITH PIVOT



- For use with glass transom and sidelight
- Recommended for use with top door patch fitting #PF120
- Capacity: 220 lbs (100 kg)

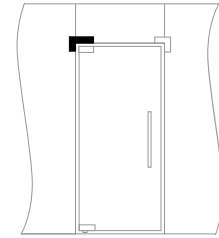

Maximum Door Size:
39 x 108 in (100 x 274 cm)

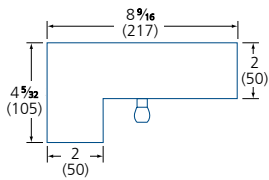

PF140	-	630
MODEL		FINISH

628	629	630	19
ALUMINUM	POLISHED STAINLESS STEEL	SATIN STAINLESS STEEL	MATTE BLACK



PF120
Top Door Patch Fitting



PATCH FITTINGS

GLASS DOORS AND PANELS

PF130 WALL MOUNT TRANSOM PATCH FITTING WITH PIVOT

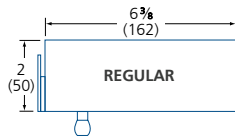

PF120
Top Door Patch Fitting

- For wall mounted installation with glass transom
- Recommended for use with top door patch fitting #PF120
- Includes machine screws and anchors
- Capacity: 220 lbs (100 kg)

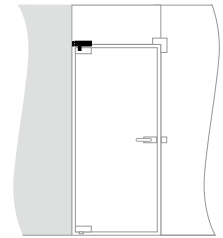

Maximum Door Size:
39 x 108 in (100 x 274 cm)

PF130	-	630
MODEL		FINISH

628	629	630	19*
ALUMINUM	POLISHED STAINLESS STEEL	SATIN STAINLESS STEEL	MATTE BLACK

(*) SPECIAL ORDER

PF131 WALL MOUNT TRANSOM PATCH FITTING WITH PIVOT - EXTENDED COVER

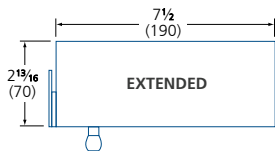

PF100DC / PF102DC
Door Closer



PF121
Top Door Patch Fitting

- For wall mounted installation with glass transom
- Recommended for use with #PF100DC or #PF102DC door closers (see page 03.060 or 03.062) and top door patch fitting #PF121
- Includes machine screws and anchors
- Capacity: 220 lbs (100 kg)

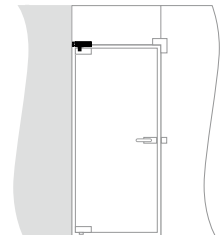

Maximum Door Size:
39 x 108 in (100 x 274 cm)

PF131	-	630
MODEL		FINISH

628	629	630	19*
ALUMINUM	POLISHED STAINLESS STEEL	SATIN STAINLESS STEEL	MATTE BLACK

(*) SPECIAL ORDER

PATCH FITTINGS

GLASS DOOR & PANELS

PF163 WALL MOUNT TRANSOM PATCH FITTING WITH DOOR STOP

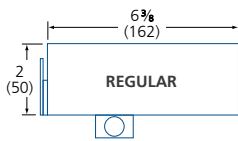

- For wall mounted installation with glass transom
- Includes regular machine screws and anchors
- Capacity: 220 lbs (100 kg)

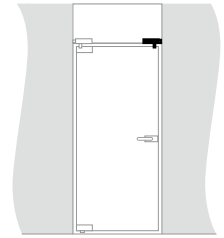

PF163	-	630
MODEL		FINISH

628	629	630	19*
ALUMINUM	POLISHED STAINLESS STEEL	SATIN STAINLESS STEEL	MATTE BLACK

(*)SPECIAL ORDER

PF164 WALL MOUNT TRANSOM PATCH FITTING WITH DOOR STOP – EXTENDED COVER

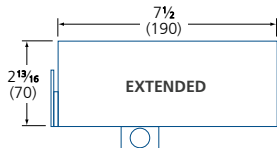

- For wall mounted installation with glass transom
- Recommended for use with #PF100DC or #PF102DC door closers (see page 03.060 or 03.062) and top door patch fitting #PF121
- Includes regular machine screws and anchors
- Capacity: 220 lbs (100 kg)

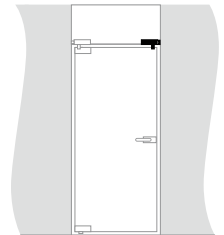

PF164	-	630
MODEL		FINISH

628	630	19*
ALUMINUM	SATIN STAINLESS STEEL	MATTE BLACK

(*)SPECIAL ORDER



PF100DC / PF102DC
Door Closer



PF121
Top Door Patch Fitting



ASSORTED HINGES

STRAP, TEE & BACK FLAP HINGES

STRAP HINGE

1209

- Heavy duty steel hinge, fixed pin
- Counter-sunk holes
- Screws not included



1209	ZP	4
MODEL	FINISH	SIZE

MODEL	HINGE SIZE (LxW)		FINISH	HOLES	SCREWS NOT INCLUDED	QTY ¹
	INCHES	MM				
1209 4	3 1/2 x 4	88.9 x 88.9	ZP	6	#8	2/10
1209 6	4 x 6	101.6 x 101.6	ZP	6	#8	2/10

(1) 2/10 : QUANTITY PER BOX / PAIRS PER CASE. HINGES NOT SOLD INDIVIDUALLY.
ZP-ZINC PLATED

TEE HINGE

1609

- Heavy duty steel hinge, fixed pin
- Counter-sunk holes
- Screws not included

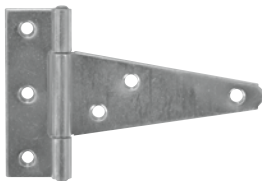

1609	ZP	4
MODEL	FINISH	SIZE

MODEL	HINGE SIZE (LxW)		FINISH	HOLES	SCREWS NOT INCLUDED	QTY ¹
	INCHES	MM				
1609 4	3 3/8 x 4	86 x 107	ZP	6	#8	2/10
1609 6	4 1/2 x 6	113 x 153	ZP	6	#8	2/5

(1) 2/10 : QUANTITY PER BOX / PAIRS PER CASE. HINGES NOT SOLD INDIVIDUALLY.
ZP-ZINC PLATED

BACK FLAP HINGE

1002, 4002, 4012

- Steel hinge, fixed or bent loose pin
- Counter-sunk holes
- Screws not included

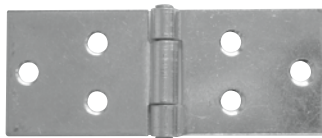

1002-114
Fixed pin

1002-114
MODEL

MODEL	HINGE SIZE (LxW)		FINISH	HOLES	SCREWS NOT INCLUDED	QTY ¹
	INCHES	MM				
1002-114	1 1/4 x 3 1/4	32 x 83	ZP	6	#6	2/10
1002-112	1 1/2 x 3 1/2	38 x 89	ZP	6	#7	2/10
1002-2	2 x 4 1/2	51 x 114	ZP	6	#8	2/10
4002	2 x 4 1/4	51 x 107	PS	6	#8	2/10
4012	2 x 4 1/4	51 x 107	PS	6	#8	2/10

(1) 2/10 : QUANTITY PER BOX / PAIRS PER CASE. HINGES NOT SOLD INDIVIDUALLY.
ZP-ZINC PLATED; PS-PLAIN STEEL

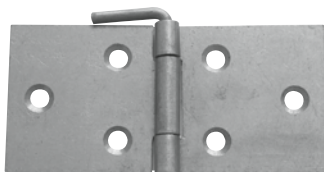

4012
Bent loose pin

ASSORTED HINGES

MISCELLANEOUS HINGES

3-LEAF PANEL HINGES

130



130, 130A,
130ST

130L

- For light weight panels
- 3½x2¼" (89x57 mm) steel hinge
- Fixed or loose pin
- Nylon bearings
- Screws NOT included

130	ST	C4
MODEL	OPTION	FINISH

AVAILABLE 50 PAIRS / BOX

OPTIONS

- A: Lose pin, assembled
- L: Extended 2½" (64mm) center leaf
- ST: Steeple tip

FINISH

- C15: Satin nickel
- C2G: Zinc plated
- C4: Satin brass

GRAVITY PIVOT HINGE – LIGHT DUTY

3000



- For ¾" (19 mm) or thicker light weight panels
- Steel with nylon bearings
- Adjustable panel plum
- Hold open at 110°
- Brass plated

3000
MODEL

AVAILABLE 10 PAIRS / BOX

LIFT-HINGE

4570



- Light duty
- 3x2¼" (76x57 mm) steel hinge
- Handed
- Swagged
- Unfinished plain steel
- Screws NOT included

4570	L
MODEL	HAND

L-LEFT; R-RIGHT AVAILABLE 10 PAIRS / BOX



ASSORTED HINGES

CONTINUOUS HINGE

CONTINUOUS HINGES

1116, 114, 112, 2, 3



- Steel hinge with steel pin
- Only available in 72" (1829mm) lengths
- Screws are not included
- Stainless steel models available—see chart
- Aluminum models available—see chart

OPTIONS

NH: No Holes

2AL	NH
MODEL	OPTION
PLEASE CONTACT FOR OPTION/FINISH AVAILABILITY	

MODEL	MATERIAL	SIZE OPEN WIDTH	HOLE SPACING	KNUCKLE WIDTH	SCREWS NOT INCLUDED	QTY ¹
3PS	Steel	3 (76)	2 (50.8)	½ (12.7)	N/A*	100
1116ST		1⅛ (27)			#5	100
114ST		1¼ (32)			#5	100
112ST	Stainless steel	1½ (38)	2 (50.8)	½ (12.7)	#6	50
2ST		2 (51)			#6	50
3ST		3 (76)			N/A*	50
112AL	Aluminum	1½ (38)	2	½	#6	100
2AL		2 (51)	(50.8)	(12.7)	#6	50

IN (MM) (*) ONLY AVAILABLE WITHOUT HOLES (1) QUANTITY PER CASE

SPECIALTY HINGES

INVISIBLE HINGES

SOSS INVISIBLE HINGES

SOSS



S220
5½" (140mm)

- For wood or metal applications
- Models can accommodate cabinet to full-sized doors
- Hinge cannot be seen or tampered with when closed
- Zinc body with steel pins
- Opens 180°
- Smooth operation
- All hinges include wood screws; machine screws available (please specify)
- Fire rated (UL Listed) models up to 180 minutes available
- Power Transfer models available
- Extreme weight or size models available
- Surface mounted models for metal cabinets available
- Steel door reinforcement plates available

Available in a wide variety of finishes, models, sizes, and options. Please contact us to order. Visit www.soss.com for product or warranty details.



S220PT
5½" (140mm)
Power Transfer



S106
2¾" (60mm)
Rear-mount

S220	FR	C26D
MODEL	OPTION	FINISH

PLEASE CONTACT TO ORDER

SOSS INVISIBLE SPRING HINGE CLOSER

SOSS

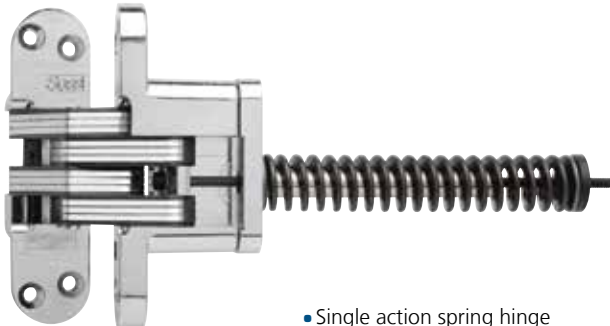

- Single action spring hinge
- For solid wood or hollow core doors 1¾–2" (35–51 mm) thick
- Maximum opening: 180°
- Hinge cannot be seen or tampered with when closed
- Adjustable closing speed after installation by hex key
- Can be installed inside door or jamb
- Recommend one spring hinge for every 20" (508 mm) height or every 55 lbs (25 kg)
- Supporting invisible hinges are required
- Fire rated (UL Listed) models up to 180 minutes available

Available in a wide variety of finishes, models, sizes, and options. Please contact us to order. Visit www.soss.com for product or warranty details.

S220IC	C26D
MODEL	FINISH

PLEASE CONTACT TO ORDER

SPECIALTY HINGES

INVISIBLE HINGES

SOSS INVISIBLE BARREL HINGES

SOSS



- Not recommended for vertical or load bearing applications - light applications only
- Hinge cannot be seen or tampered with when closed
- Easy press-fit installation; additional screw can be used to additional strength on some sizes
- Solid brass
- Opens to 180°

Available in a wide variety of finishes, models, sizes, and options. Please contact us to order. Visit www.soss.com for product or warranty details.

SBH124	C4
MODEL	FINISH

PLEASE CONTACT TO ORDER



SPECIALTY HINGES

POWER TRANSFER

ABH POWER TRANSFER – PRE-WIRED

ABH-PT200, ABH-PT1000



- Allows transferring electrical power & data from the frame to the door in a secure and discreet manner.
- Unit mortises into the edges of the door and frame and is completely concealed when the door is in the closed position.
- All metal construction including backboxes - NO PLASTIC PARTS
- Ideal for high abuse or heavy traffic situations
- UL/ULC Listed for use on fire doors
- For doors at least 1 $\frac{3}{4}$ " (45mm) thick
- Maximum door opening: 180°
- Not for use with swing clear hinges, pocket pivots, butt hinges larger than 6" (152 mm), 1 $\frac{1}{2}$ " (38mm) offset pivots or center hung doors
- ABH-PT200: (2) 18 AWG Wires (Max. 24VDC, 5A or 120VAC NEC Class 3), Max. Surge (In-Rush): 16A
- ABH-PT1000: (10) 24 AWG Wires (MAX. 24VDC, 1A)

Available in a wide variety of finishes and options
– please contact to order or visit www.abhmfg.com for details

ABH-PT200	–	28
MODEL		FINISH

PLEASE CONTACT TO ORDER

ABH POWER TRANSFER

ABH-PT105, AB-PT180



- Models provide housing for running wires from the frame to the door in a secure and discreet manner
- Stainless steel housing and spring conduit
- Spring conduit fits wire bundles up to $\frac{5}{16}$ " (8mm) thick
- Works with most butt hinges, continuous hinges and $\frac{3}{4}$ " (19mm) offset pivots
- Maximum door opening
 - » ABH-PT105: 105°
 - » ABH-PT180: 180°
- Available with square or round corners

Available in a wide variety of finishes and options
– please contact to order or visit www.abhmfg.com for details

ABH-PT105	–	32D
MODEL		FINISH

PLEASE CONTACT TO ORDER

SPECIALTY HINGES

POWER TRANSFER

DOOR LOOP

SDL-20



- A door loop is a simple method of transferring low voltage power from the door frame to the locking device
- Commonly used with electric mortise and cylindrical locks, electric exit trims and latch pullback devices.
- Surface mounted
- Non-wired
- Field sizeable flexible armoured conduit
- Minimum conduit length included: 20" (508mm)
- Maximum electrical wires: 7 ea. 18 awg, 10 ea. 22 awg
- Pre-drilled mounting holes
- Available in aluminum finish (AL)
- Dark bronze finish available by special order

SDL-20	AL
MODEL	FINISH

AL: ALUMINUM

DOOR LOOP – CONCEALED

CDL



- A door loop is a simple method of transferring low voltage power from the door frame to the locking device
- Unlike surface door loops, the armoured conduit slides into the door and/or door frame.
- For continuous or butt hinge, full mortise, half mortise or half surface applications
- Supports up to 180° openings
- Concealed mounting
- Non-wired
- Flexible 6" (152.4 mm) armoured conduit, 1/4" (6.4 mm) diameter
- Aluminum end-caps

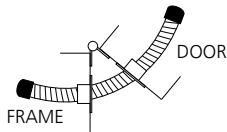
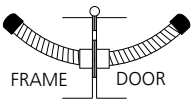

CDL	-	AL
MODEL		FINISH

AL: ALUMINUM



SPECIALTY HINGES

POWER TRANSFER

POWER TRANSFER HINGE

JC-603QC-BB1079

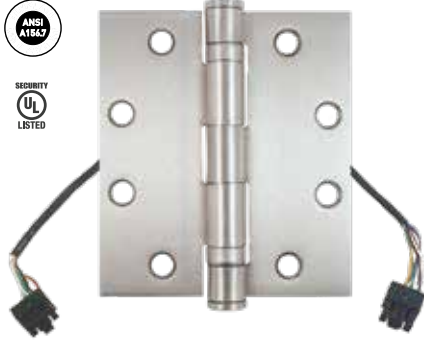

- Standard weight, full mortise
- 5 knuckles, 2 ball bearings
- Steel with non-removable steel pin
- ANSI/BHMA A156.7 template hole pattern
- UL Security Listed

- For hollow door and frame
- 8 or 4 wire transfer with molex connector
- Wood and undercut machine screws included
- Must be installed with two other ball bearing hinges of the same size

OPTIONS

ETW04: 4 Wires

ETW08: 8 Wires

WIRING DETAILS

- Wiring: 28 AWG stranded w/PTFE insulation, NEMA HP-3
- Maximum Amp: 4 amp continuous for wires up to 9in (228.6mm) @ 24v AC or DC
EX: 8 wires = 0.5amp / wire
- Maximum Surge (in-rush):
16amp pulse for 300msec/
10amp pulse for 250 msec.

JC-603QC0-BB1079	- 454 -	26D	- ETW08
MODEL	SIZE	FINISH	OPTION

SIZE	INCHES	MM	LEAF GAUGE	HOLES	SCREWS INCLUDED		QTY ¹
					MACHINE	WOOD	
454*	4½ x 4	114.3 x 101.6	0.134	8	#12-24 x ½	#12 x 1 ¼	1

(1) SOLD BY UNIT. (*) FIRE RATING AS PER NFPA80 GUIDELINES.

1D	26D
MATTE BLACK LACQUER	SATIN CHROME

OTHER SIZES AND FINISHES AVAILABLE BY SPECIAL ORDER, PLEASE CONTACT FOR DETAILS.

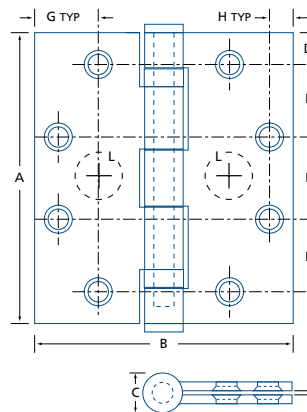

MODEL	A	B	C	D	E	F	G	H	K	øL*
JC-603QC-BB1079 454	4½ (114.3)	4 (101.6)	19/32 (15.2)	½ (12.7)	1 1/8 (28.6)	1 15/64 (31)	1 (25.4)	3/8 (9.5)	1/16 (1.6)	19/32 (ø15)

DIMENSIONS IN INCHES (MILLIMETRES) AS PER ANSI A156.7. SEE INSTALLATION INSTRUCTIONS FOR DETAILS.

*DIMENSION OF THE NODE, NOT FRAME PREPARATION.