

DOOR CONTROL TABLE OF CONTENTS

Door Closer Guide	ii
Door Closer Features.....	ii
Door Handing Guide.....	ii
Finish Guide.....	iii
Abbreviation Guide.....	iii

SURFACE DOOR CLOSERS

DOREX 441HD Series, Heavy Duty, Grade 1	03.005
DOREX 441 Series, Grade 1	03.006
DOREX 1901 Series, Grade 1 BHMA	03.010
DOREX 1900 Series, Grade 1	03.011
DOREX 1701 Series, Grade 1 BHMA	03.022
DOREX 1700 Series, Grade 1	03.024
DOREX 1761 Series.....	03.026
DOREX 851 Series, Grade 1 BHMA	03.030
DOREX 700 Series.....	03.040
D8DIVISION8 300 Series	03.044
D8DIVISION8 DC300 Series	03.045
TC603 Series.....	03.046

CONCEALED DOOR CLOSERS

DOREX DC3000 Series, Concealed in door.....	03.051
DOREX 30 Series, Concealed in transom	03.052
DOREX 40 Series, Concealed in floor.....	03.054
Concealed Spring Closers.....	03.056
PF100 Hydraulic Patch Fitting Closer	03.060
PF102 Hydraulic Patch Fitting Closer	03.062

AUXILIARY

Door Check	03.072
------------------	--------

OVERHEAD HOLDERS & STOPS

Concealed	03.100
Surface Mounted	03.102

DOOR COORDINATORS

Surface Mounted	03.200
Gravity Coordinator	03.201
Mullion.....	03.210

ELECTROMAGNETIC DOOR HOLDERS

Wall Mounted.....	03.300
Floor Mounted.....	03.301

R2020618



DOOR CLOSER GUIDE

REGULAR MOUNT
(PULL SIDE)

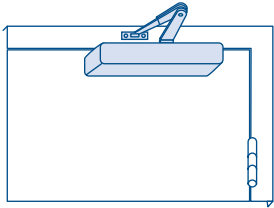

TOP JAMB MOUNT
(PUSH SIDE)

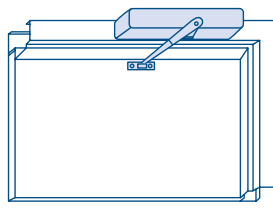

PARALLEL MOUNT
(PUSH SIDE)

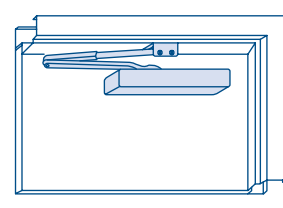

DOOR CLOSER FEATURES

SWEEP / LATCH SPEED

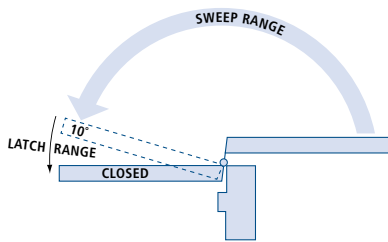

DELAYED ACTION

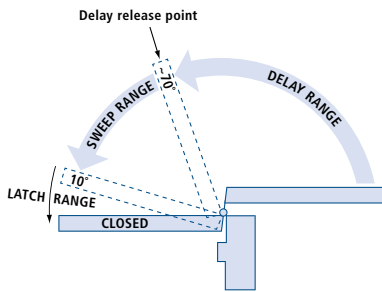

BACKCHECK

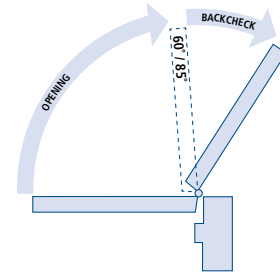

NOTE: CUSHIONING BACKCHECK DOES NOT REPLACE A PHYSICAL DOOR STOP.

DOOR HANDING GUIDE

LEFT HAND (LH)

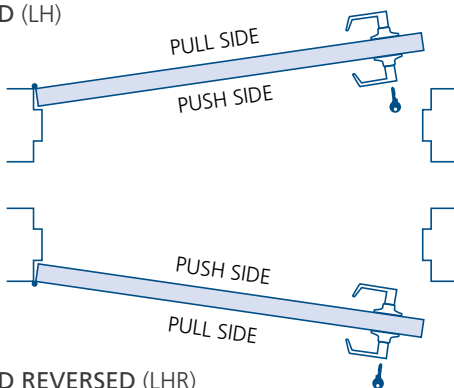

RIGHT HAND (RH)

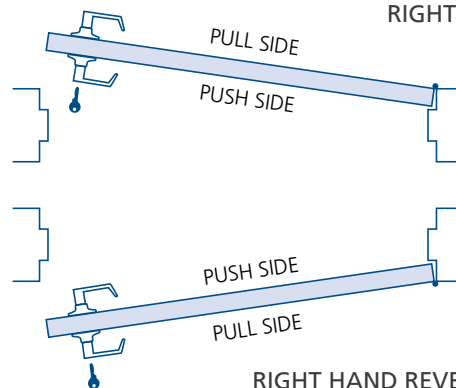







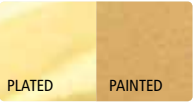

LEFT HAND REVERSED (LHR)

RIGHT HAND REVERSED (RHR)

PLEASE CONTACT OUR DOOR HARDWARE SPECIALISTS IF YOU HAVE ANY QUESTIONS CONCERNING OUR PRODUCTS OR NEED ASSISTANCE IN SELECTING THE CORRECT DOOR HARDWARE FOR YOUR APPLICATION OR SITUATION.

DOOR CONTROL GENERAL INFORMATION

FINISH GUIDE

					
	PAINTED	PLATED PAINTED			
	ALUMINUM	BRASS	DARK BRONZE	MATTE BLACK	SATIN NICKEL
CODE	AL, C28, 28	BP, PB, C3, 3	DJ, C20D, 20D	MB, C19, 19	SDN, SN, C15, 15
BHMA*	628, 689	605, 632, 677	649, 650, 690	622, 631	619, 646
					
	SATIN CHROME	SATIN STAINLESS STEEL	POLISHED STAINLESS STEEL	PLAIN STEEL, NO FINISH	
CODE	SC, C26D, 26D	SS, C32D, 32D	C32, 32	PS, SP	
BHMA*	626, 652	630	629		

ALL FINISHES IMAGES ABOVE ARE PHOTOGRAPHIC OR COLOUR APPROXIMATIONS, DELIVERED PRODUCT MAY VARY IN COMPARISON OR BETWEEN ORDERS/LOTS.

OTHER FINISHES AVAILABLE—PLEASE CONTACT.





(*) EQUIVALENT; CODES DIFFER DEPENDING ON BASE MATERIAL AND/OR FINISH PROCESS.

ABBREVIATION GUIDE

GENERAL

DIA, ∅	Diameter
KG	Kilograms
LBS	Pounds
LH	Left hand
LHR	Left hand reversed
MAX	Maximum
MIN	Minimum
N/A, —	Not applicable / Not available
QTY	Quantity (usually followed by notes)
RH	Right hand
RHR	Right hand reversed
SQ, ∅	Square
WT	Weight
/UNIT	Number of items per basic unit of sale (bagged or boxed)
/BOX, /BAG	Number of UNITS found in an inner carton or bag
/CASE	Number of BOXES or UNITS found in an outer (shipping) carton

LEGEND

	Product, configuration or option meets ADA (Americans with Disabilities Act) requirements.
	GRADE 1 product meets or exceeds standardized testing requirements for high traffic, commercial applications.
	Tested to Canadian and/or American safety and performance standards by Underwriters Laboratories® (UL).
	Certified by the Builders Hardware Manufacturers Association® / American National Standards Institute®.
	Limited warranty length in years, applicable to mechanical, electronic, or finish aspects of a product.



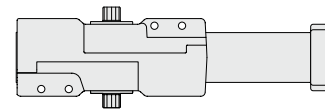

- Certifications**
- Conforms to ANSI/BHMA A156.4, Grade 1
 - cULus listed, 3hr fire-rating
 - ADA compliant, barrier free
 - 15 Year limited warranty
- Power Size**
- Adjustable size 1-6 (preset 3)
- See selection guide for details*
- Body Material**
- Heavy duty precision cast iron body, painted finish
- Mechanism**
- Hydraulic rack and pinion operation
- Fluid**
- Non-gumming, non-freezing hydraulic fluid
 - Operating range of -39° to 49° C (-38° to 120°F)
- Adjustments**
- Sweep speed adjustment valve
 - Latching speed adjustment valve
 - Cushioning backcheck adjustment valve
 - Delayed action adjustment valve
- Cover**
- Full body plastic cover, painted finish
- Handing**
- Non-handed
- Opening**
- 120° maximum
 - 180° maximum with parallel arm

- Mounting**
- Tri-Pack: regular¹, top jamb¹, parallel arm²
 - Maximum reveal: 2¾" (70 mm)
 - Forearm extension³ – available
 - Drop plates – available
- (1) Arm allows 15% power adjustment*
(2) May reduce spring power efficiency by 25%
(3) For reveal up to 5" (127 mm)
- Hardware**
- Wood screws & self-tapping machine screws
 - Sex nuts & thru-bolts
- Available Arms**
- Extra duty parallel arm
 - Heavy duty cushion stop arm, hold open
 - Heavy duty cushion stop arm, no hold open
 - Heavy duty spring stop arm, no hold open
- Finish**
- AL**–Aluminum, painted; **MB**–Matte black, painted
- Other finishes available by special order*

441HD BC – AL
 MODEL FINISH

SEE SELECTION GUIDE FOR DETAILS

SELECTION GUIDE

MODEL	POWER SIZE	WEIGHT CAPACITY ¹	MAX. DOOR WIDTH ²		BACKCHECK	DELAYED ACTION	FINISH	/CASE
			INTERIOR	EXTERIOR				
441HDBC REGULAR ARM	1-6	330 (150)	60 (1524)	48 (1219)	■	■	AL, MB	2
441HDBCH CUSHION-STOP ARM, HOLD OPEN*								

CAUTION: ANY DOOR CLOSER INSTALLED AND ADJUSTED BASED ON ADA REDUCED FORCE REQUIREMENTS MAY NOT RELIABLY CLOSE AND LATCH DOOR.
 (1) WEIGHT CAPACITY IN POUNDS (KILOGRAMS) (2) MAXIMUM DOOR WIDTH IN INCHES (MILLIMETRES) (*) NOT FOR USE ON FIRE RATED DOORS

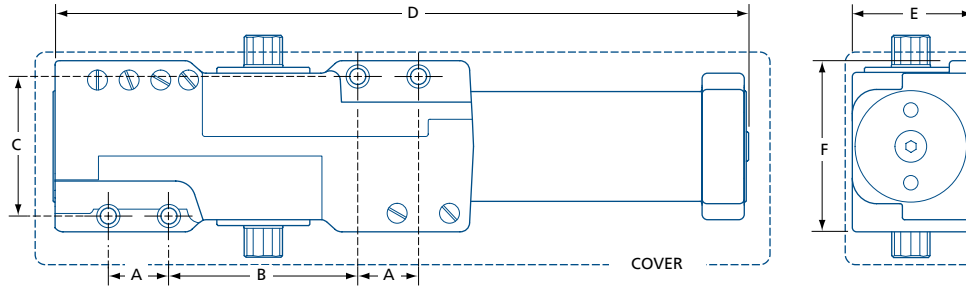

MODEL	A	B	C	D	E	F
441HD	1 (25)	3 (76)	2¼ (57)	11¼ (281)	2 (51)	2¾ (70)
441HD with cover	1 (25)	3 (76)	2¼ (57)	12¾ (309)	2¼ (57)	3½ (89)

IN (MM)

PARTS & ACCESSORIES



ARM441HDC
Heavy duty cushion stop arm, no hold open.



ARM441HDH
Heavy duty cushion stop arm, hold open.
Not for use on fire rated doors. *Included with 441HDBCH.*



ARM441HDE
Parallel arm for extra-duty applications.



ARM441HDLR
Long forearm link for reveal greater than 2¾" (70 mm) up to 5" (127 mm).



DP441HD-18PA
For parallel arm installations where the door top rail height is insufficient for direct mounting.



DP441HD-18RG
For regular arm installations where the door top rail height is insufficient for direct mounting OR for top jamb installations where low ceiling prevents direct mounting.



DP441HD-18TJ
For top jamb installations where the door frame header height is insufficient for direct mounting.



SNB1420
Aluminum sex nut & steel thru-bolt kit (4) for doors 1¾" (44.5 mm) thick.

SNB51420
Steel sex nut & thru-bolt kit (4) for doors 1¾" (44.5 mm) thick.



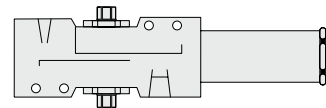

- Certifications**
- Conforms to ANSI/BHMA A156.4, Grade 1
 - cULus listed, 3hr fire-rating
 - ADA compliant, barrier free
 - 10 Year limited warranty
- Power Size**
- Adjustable size 1-6 (preset 3)
- See selection guide for details*
- Body Material**
- Precision cast iron body, painted finish
- Mechanism**
- Hydraulic rack and pinion operation
- Fluid**
- Non-gumming, non-freezing hydraulic fluid
 - Operating range of -30° to 49° C (-22° to 120° F)
- Adjustments**
- Sweep speed adjustment valve
 - Latching speed adjustment valve
 - Cushioning backcheck adjustment valve
- Cover**
- Full body plastic cover, painted finish
- Handing**
- Non-handed
- Opening**
- 120° maximum
 - 180° maximum with parallel arm

- Mounting**
- Tri-Pack: regular¹, top jamb¹, parallel arm²
 - Maximum reveal: 3" (76 mm)
 - Forearm extensions³ – available
 - Drop plates – available

(1) Arm allows 15% power adjustment

(2) May reduce spring power efficiency by 25%

(3) For reveal up to 5" (127 mm) or 9" (228 mm)

- Hardware**
- Wood screws & self-tapping machine screws
 - Sex nuts & thru-bolts

- Available Arms**
- Extra duty parallel arm
 - Friction hold open arm
 - Heavy duty cushion stop arm, hold open
 - Heavy duty cushion stop arm, no hold open
 - Heavy duty spring stop arm, no hold open

- Finish**
- AL–Aluminum, painted;
 - DU–Dark bronze, painted

Other finishes available by special order

441 BC	-	AL
MODEL		FINISH

SEE SELECTION GUIDE FOR DETAILS

SELECTION GUIDE

MODEL	POWER SIZE	WEIGHT CAPACITY ¹	MAX. DOOR WIDTH ²		BACKCHECK	DELAYED ACTION	FINISH	/CASE
			INTERIOR	EXTERIOR				
441 BC REGULAR ARM	Ⓢ						AL, DU	6
441 BCC CUSHION-STOP ARM, NO HOLD OPEN	Ⓢ	1-6	330 (150)	60 (1524)	●	—	AL	4
441 BCH CUSHION-STOP ARM, HOLD OPEN*	Ⓢ						AL	4

CAUTION: ANY DOOR CLOSER INSTALLED AND ADJUSTED BASED ON ADA REDUCED FORCE REQUIREMENTS MAY NOT RELIABLY CLOSE AND LATCH DOOR.
(1) WEIGHT CAPACITY IN POUNDS (KILOGRAMS) (2) MAXIMUM DOOR WIDTH IN INCHES (MILLIMETRES) (*) NOT FOR USE ON FIRE RATED DOORS

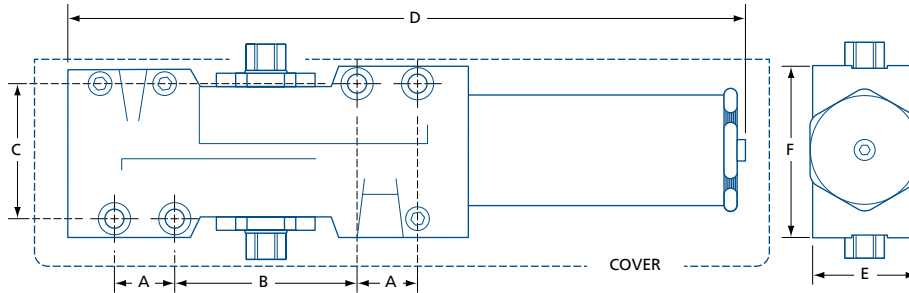

MODEL	A	B	C	D	E	F
441	1 (25)	3 (76)	2¼ (57)	11½ (287)	2 (51)	2¾ (70)
441 with cover	1 (25)	3 (76)	2¼ (57)	12¼ (311)	2¼ (57)	3½ (89)

IN (MM)

PARTS & ACCESSORIES



ARM441C
Heavy duty cushion stop arm, no hold open.
Included with 441BCC.



ARM441H
Heavy duty cushion stop arm, hold open.
Not for use on fire rated doors. *Included with 441BCH.*



ARM441E
Parallel arm for extra-duty applications.



ARM441HS
Heavy duty spring stop arm, hold open. Not for use on fire rated doors.



ARM441S
Heavy duty spring stop arm, no hold open.



ARM441F
Adjustable friction hold open arm, for standard, top jamb or parallel arm installation. Not for use on fire rated doors.



441LR
Long forearm link for reveal greater than 3" (76) up to 5" (127 mm).



441ELR
Extra long forearm link for reveals up to 5-9" (127-228 mm).



DP441-18
For regular arm installations where the door top rail height is insufficient for direct mounting.



DP441-18G
For top jamb installations where low ceiling clearance prevents direct mounting.



DP441-18PA
For parallel arm installations where the door top rail height is insufficient for direct mounting.



DP441-18TJ
For top jamb installations where the door frame header height is insufficient for direct mounting.



SNB1420
Aluminum sex nut & steel thru-bolt kit (4) for doors 1¾" (44.5 mm) thick.





- Certifications**
- Certified ANSI/BHMA A156.4, Grade 1
 - cULus listed, 3hr fire-rating
 - ADA compliant, barrier free
 - 10 Year limited warranty

- Power Size**
- Adjustable size 1-6 (preset 3)
- See selection guide for details*

- Body Material**
- Cast aluminum body, painted finish

- Mechanism**
- Hydraulic rack and pinion operation

- Fluid**
- Non-gumming, non-freezing hydraulic fluid
 - Operating range of -35° to 49°C (-31° to 120°F)

- Adjustments**
- Sweep speed adjustment valve
 - Latching speed adjustment valve
 - Cushioning backcheck adjustment valve
 - Delayed action adjustment valve – option

- Cover**
- Full body plastic cover, painted finish
 - Full body metal cover, plated finish (BP finish only) – option

- Handing**
- Non-handed

- Opening**
- 180° maximum

- Mounting**
- Tri-Pack: regular¹, top jamb¹, parallel arm²
 - Maximum reveal: 2¾" (70mm)
 - Drop plates – available

*(1) Arm shoe allows ±7.5% power adjustment
(2) May reduce spring power efficiency by 25%*

- Hardware**
- Wood screws & self-tapping machine screws
 - Sex nuts & thru-bolts

- Available Arms**
- Friction hold open arm
 - Heavy duty cushion stop arm, hold open
 - Heavy duty cushion stop arm, no hold open
 - Heavy duty spring stop arm, no hold open

- Finish**
- AL–Aluminum, painted; BP–Brass, plated; DU–Dark bronze, painted; MB–Matte black, painted

Other finishes available by special order

1901BC – AL
MODEL FINISH

SEE SELECTION GUIDE FOR DETAILS

SELECTION GUIDE

MODEL	POWER SIZE	WEIGHT CAPACITY ¹	MAX. DOOR WIDTH ²		BACKCHECK	DELAYED ACTION	FINISH	/CASE
			INTERIOR	EXTERIOR				
1901 BC REGULAR ARM	1-6	330 (150)	54 (1372)	48 (1219)	●	—	AL, BP, DU, MB	6
1901 BCDA REGULAR ARM								
1901 HC CUSHION-STOP ARM, HOLD OPEN*	1-6	330 (150)	54 (1372)	48 (1219)	●	—	AL	4
1901 NHC CUSHION-STOP ARM, NO HOLD OPEN								

CAUTION: ANY DOOR CLOSER INSTALLED AND ADJUSTED BASED ON ADA REDUCED FORCE REQUIREMENTS MAY NOT RELIABLY CLOSE AND LATCH DOOR.
 (1) WEIGHT CAPACITY IN POUNDS (KILOGRAMS) (2) MAXIMUM DOOR WIDTH IN INCHES (MILLIMETRES) (*) NOT FOR USE ON FIRE RATED DOORS

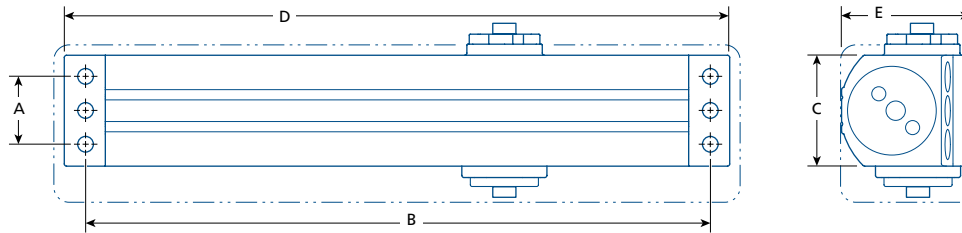

MODEL	A	B	C	D	E
1901	1 ¹ / ₈ (29)	11 ¹ / ₈ (283)	2 (51)	11 ⁷ / ₈ (302)	2 ³ / ₈ (61)
1901 with cover	1 ¹ / ₈ (29)	11 ¹ / ₈ (283)	3 (76)	12 ¹ / ₈ (308)	2 ¹ / ₂ (64)

IN (MM)

PARTS & ACCESSORIES



1901-CSA
Heavy-duty cushion stop arm, hold open.
Not for use on fire rated doors. *Included with 1901HC door closer.*



1901-CSANHO
Heavy-duty cushion stop arm, no hold open.
Included with 1901NHC door closer.



1901-SCSANHO
Heavy-duty cushion spring stop arm, no hold open.



1901-ARMF
Regular arm with adjustable friction hold open. Includes parallel arm bracket. Not for use on fire rated doors.



1901SANHO
Sliding arm, no hold open - for fire rated operation.

1901SAHO
Sliding arm, hold open - not for use on fire rated operation.



1901-DP
For regular arm installations where the door top rail height is insufficient for direct mounting.



1901-DPTJ
For top jamb installations where low ceiling clearance prevents direct mounting.



1901-DPTJN
Narrow plate for top jamb installations where the door frame header height is insufficient for direct mounting.



1901-DPPA
For parallel arm installations where the door top rail height is insufficient for direct mounting.



SNBS1420
Steel sex nut & thru-bolt kit (4) for doors 1³/₄" (44.5mm) thick.





- Certifications**
- Conforms to ANSI/BHMA A156.4, Grade 1
 - cULus listed, 3hr fire-rating
 - ADA compliant barrier free model – available
 - 10 Year limited warranty

- Power Size**
- Adjustable size 2-6 (preset 3)
 - Adjustable size 1-4 (preset 2), barrier free

See selection guide for details

- Body Material**
- Cast aluminum body, painted finish

- Mechanism**
- Hydraulic rack and pinion operation

- Fluid**
- Non-gumming, non-freezing hydraulic fluid
 - Operating range of -35° to 49°C (-31° to 120°F)

- Adjustments**
- Sweep speed adjustment valve
 - Latching speed adjustment valve
 - Cushioning backcheck adjustment valve
 - Delayed action adjustment valve – option

- Cover**
- Full body plastic cover, painted finish

- Handing**
- Non-handed

- Opening**
- 180° maximum

- Mounting**
- Tri-Pack: regular¹, top jamb¹, parallel arm²
 - Maximum reveal: 2¾" (70mm)
 - Drop plates – available

*(1) Arm shoe allows ±7.5% power adjustment
(2) May reduce spring power efficiency by 25%*

- Hardware**
- Wood screws & self-tapping machine screws
 - Sex nuts & thru-bolts – available

- Available Arms**
- Regular arm with adjustable hold open
 - Heavy duty cushion stop arm, hold open
 - Heavy duty cushion stop arm, no hold open
 - Sliding arm with optional hold open

- Finish**
- AL–Aluminum, painted; DU–Dark bronze, painted; MB–Matte black, painted

Other finishes available by special order

1900BF – AL
MODEL FINISH

SEE SELECTION GUIDE FOR DETAILS

SELECTION GUIDE

MODEL	POWER SIZE	WEIGHT CAPACITY ¹	MAX. DOOR WIDTH ²		BACKCHECK	DELAYED ACTION	FINISH	/CASE
			INTERIOR	EXTERIOR				
1900	2-6	330 (150)	54 (1372)	48 (1219)	•	—	AL, DU, MB	6
1900 BF 	1-4	265 (120)	48 (1219)	42 (1067)	•	•	AL, DU	6

CAUTION: ANY DOOR CLOSER INSTALLED AND ADJUSTED BASED ON ADA REDUCED FORCE REQUIREMENTS MAY NOT RELIABLY CLOSE AND LATCH DOOR.
 (1) WEIGHT CAPACITY IN POUNDS (KILOGRAMS) (2) MAXIMUM DOOR WIDTH IN INCHES (MILLIMETRES)

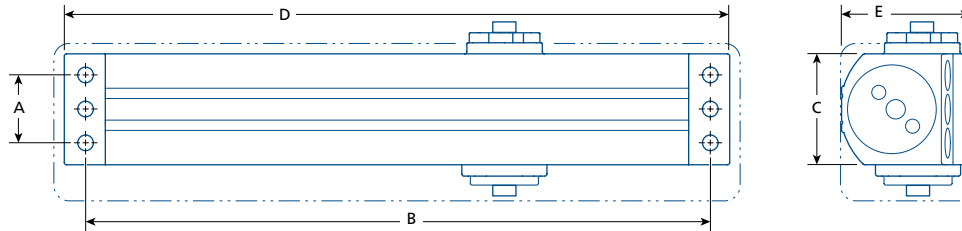

MODEL	A	B	C	D	E
1900	1 ¹ / ₈ (29)	11 ¹ / ₈ (283)	2 (51)	11 ⁷ / ₈ (302)	2 ³ / ₈ (61)
1900 with cover	1 ¹ / ₈ (29)	11 ¹ / ₈ (283)	3 (76)	12 ¹ / ₈ (308)	2 ¹ / ₂ (64)

IN (MM)

PARTS & ACCESSORIES



CSA1900
Heavy-duty cushion stop arm, hold open.
Not for use on fire rated doors.



DP1900
For parallel arm installations where the door top rail height is insufficient for direct mounting.



CSANHO1900
Heavy-duty cushion stop arm, no hold open.



735
Parallel arm bracket.



HOA1900
Regular arm with adjustable hold open and parallel arm bracket. Not for use on fire rated doors.



SNB1420
Aluminum sex nut & steel thru-bolt kit (4) for doors 1³/₄" (44.5 mm) thick.



SA1900
Sliding arm with optional hold open. Not for use on fire rated doors.





BHMA
CERTIFIED

G1

cUL US
LISTED

3H

♿

10
YEAR

- Certifications**
- Certified ANSI/BHMA A156.4, Grade 1
 - cULus listed, 3hr fire-rating
 - ADA compliant, barrier free
 - 10 Year limited warranty

- Power Size**
- Adjustable size 1–5 (preset 3)

- Body Material**
- Cast aluminum body, painted finish

- Mechanism**
- Hydraulic rack and pinion operation

- Fluid**
- Non-gumming, non-freezing hydraulic fluid
 - Operating range of -30° to 49° C (-22° to 120° F)

- Adjustments**
- Sweep speed adjustment valve
 - Latching speed adjustment valve
 - Cushioning backcheck adjustment valve

- Cover**
- Low-profile, plastic cover with pinion cap, painted finish

- Handing**
- Non-handed

- Opening**
- 180° maximum

- Mounting**
- Tri-Pack: regular¹, top jamb¹, parallel arm²
 - Maximum reveal: 2¾" (70 mm)
 - Forearm extension³ – available
 - Drop plates – available

(1) Arm shoe allows ±7.5% power adjustment

(2) May reduce spring power efficiency by 25%

(3) For reveal up to 6¼" (159 mm)

- Hardware**
- Wood screws & self-tapping machine screws
 - Sex nuts & thru-bolts

- Available**
- Friction hold open arm

- Arms**
- Heavy duty cushion stop arm, hold open
 - Heavy duty cushion stop arm, no hold open
 - Heavy duty spring stop arm, no hold open

- Finish**
- AL–Aluminum, painted; DU–Dark bronze, painted; MB–Matte black, painted

Other finishes available by special order

1701 BC – AL

MODEL FINISH

SEE SELECTION GUIDE FOR DETAILS

SELECTION GUIDE

MODEL	POWER SIZE	WEIGHT CAPACITY ¹	MAX. DOOR WIDTH ²		BACKCHECK	DELAYED ACTION	FINISH	/CASE
			INTERIOR	EXTERIOR				
1701 BC	⑤ 1-5	265 (120)	48 (1219)	42 (1067)	●	—	AL, DU, MB	10

CAUTION: ANY DOOR CLOSER INSTALLED AND ADJUSTED BASED ON ADA REDUCED FORCE REQUIREMENTS MAY NOT RELIABLY CLOSE AND LATCH DOOR.
 (1) WEIGHT CAPACITY IN POUNDS (KILOGRAMS) (2) MAXIMUM DOOR WIDTH IN INCHES (MILLIMETRES)

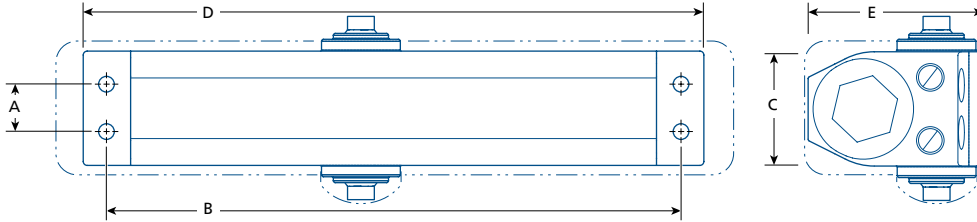

MODEL	A	B	C	D	E
1701	3/4 (19)	9 1/16 (230)	1 3/4 (44.5)	9 3/4 (248)	2 7/8 (73)
1701 with cover ¹	3/4 (19)	9 1/16 (230)	2 1/16 (53)	10 9/16 (269)	3 (76)

IN (MM) (1) ALL MODELS INCLUDE PINION CAP AND SLIM BODY COVER.

PARTS & ACCESSORIES



1901-CSA
Heavy-duty cushion stop arm, hold open. Not for use on fire rated doors.



1901-CSANHO
Heavy-duty cushion stop arm, no hold open.



1901-SCSANHO
Heavy-duty cushion spring stop arm, no hold open.



1901-ARMF
Regular arm with adjustable friction hold open. Includes parallel arm bracket. Not for use on fire rated doors.



1701-EXT
Arm extension rod for top jamb installation with reveal between 2 3/4-6 1/4" (70-159 mm).



1901SANHO
Sliding arm, no hold open - for fire rated operation.

1901SAHO
Sliding arm, hold open - not for use on fire rated operation.



1701-DP
Narrow plate for top jamb installations with low ceiling clearance or for regular arm installations where the door top rail height is insufficient for direct mounting.



1701-DPPA
For parallel arm installations where the door top rail height is insufficient for direct mounting.



SNBS1420
Steel sex nut & thru-bolt kit (4) for doors 1 3/4" (44.5 mm) thick.





- Certifications**
- Conforms to ANSI/BHMA A156.4, Grade 1
 - cULus listed, 3hr fire-rating
 - ADA compliant barrier free model –available
 - 5 Year limited warranty

- Power Size**
- Adjustable size 2-5 (preset 3)
 - Adjustable size 1-4 (preset 2), barrier free

See selection guide for details

- Body Material**
- Cast aluminum body, painted finish

- Mechanism**
- Hydraulic rack and pinion operation

- Fluid**
- Non-gumming, non-freezing hydraulic fluid
 - Operating range of -15° to 40°C (5° to 104°F)

- Adjustments**
- Sweep speed adjustment valve
 - Latching speed adjustment valve
 - Cushioning backcheck adjustment valve

- Cover**
- Low-profile, plastic cover with pinion cap, painted finish

- Handing**
- Non-handed
- Opening**
- 180° maximum

- Mounting**
- Tri-Pack: regular¹, top jamb¹, parallel arm²
 - Maximum reveal: 3" (76mm)
 - Drop plates – available

(1) Arm shoe allows ±7.5% power adjustment

(2) May reduce spring power efficiency by 25%

- Hardware**
- Wood screws & self-tapping machine screws
 - Sex nuts & thru-bolts

- Available Arms**
- Regular arm
 - Sliding arm with optional hold open

- Finish**
- AL–Aluminum, painted; BP–Brass, painted; DU–Dark bronze, painted

Other finishes available by special order

1700BF – AL
MODEL FINISH

SEE SELECTION GUIDE FOR DETAILS

SELECTION GUIDE

MODEL	POWER SIZE	WEIGHT CAPACITY ¹	MAX. DOOR WIDTH ²		BACKCHECK	DELAYED ACTION	FINISH	/CASE
			INTERIOR	EXTERIOR				
1700	2-5	265 (120)	48 (1219)	42 (1067)	●	—	AL, BP, DU	10
1700 BF 	1-4	190 (86)	42 (1067)	—	●	—	AL	10

CAUTION: ANY DOOR CLOSER INSTALLED AND ADJUSTED BASED ON ADA REDUCED FORCE REQUIREMENTS MAY NOT RELIABLY CLOSE AND LATCH DOOR.
 (1) WEIGHT CAPACITY IN POUNDS (KILOGRAMS) (2) MAXIMUM DOOR WIDTH IN INCHES (MILLIMETRES)

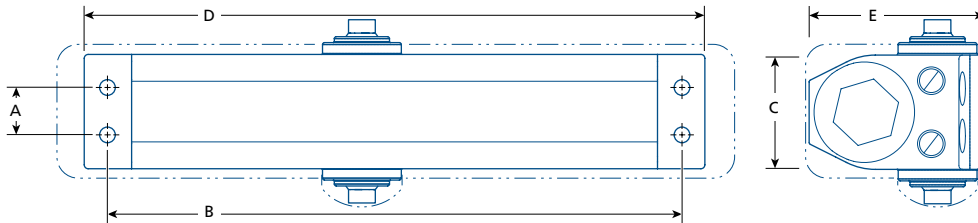

MODEL	A	B	C	D	E
1700	3/4 (19)	9 1/16 (230)	1 3/4 (44.5)	9 3/4 (248)	2 7/8 (73)
1700 with cover ¹	3/4 (19)	9 1/16 (230)	2 1/16 (53)	10 9/16 (269)	3 (76)

IN (MM) (1) ALL MODELS INCLUDE PINION CAP AND SLIM BODY COVER.

PARTS & ACCESSORIES



ARM754
Replacement regular arm.



SA1900
Sliding arm with optional hold open. Not for use on fire rated doors.



SNB1420
Aluminum sex nut & steel thru-bolt kit (4) for doors 1 3/4" (44.5 mm) thick.



DP754
For parallel arm installations where the door top rail height is insufficient for direct mounting.



DPN754
Narrow plate for top jamb installations with low ceiling clearance or for regular arm installations where the door top rail height is insufficient for direct mounting.



735
Parallel arm bracket.





- Certifications**
- cULus listed, 3hr fire-rating
 - ADA compliant, barrier free
 - 5 Year limited warranty

- Power Size**
- Adjustable size 1–5 (preset 3)
- See selection guide for details*

- Body Material**
- Cast aluminum body, painted finish

- Mechanism**
- Hydraulic rack and pinion operation

- Fluid**
- Non-gumming, non-freezing hydraulic fluid
 - Operating range of -39° to 49°C (-38° to 120°F)

- Adjustments**
- Sweep speed adjustment valve
 - Latching speed adjustment valve
 - Cushioning backcheck adjustment valve

- Cover**
- Plastic pinion cap, painted finish

- Handing**
- Non-handed

- Opening**
- 180° maximum

- Mounting**
- Tri-Pack: regular¹, top jamb¹, parallel arm²
 - Maximum reveal: 2½" (64.5 mm)

*(1) Arm shoe allows ±7.5% power adjustment
(2) May reduce spring power efficiency by 25%*

- Hardware**
- Wood screws & self-tapping machine screws
 - Sex-nut & thru-bolts

- Available Arms**
- Regular arm

- Finish**
- AL–Aluminum, painted; DU–Dark bronze, painted

Other finishes available by special order

1761 – AL
MODEL FINISH

SEE SELECTION GUIDE FOR DETAILS

SELECTION GUIDE

MODEL	POWER SIZE	WEIGHT CAPACITY ¹	MAX. DOOR WIDTH ²		BACKCHECK	DELAYED ACTION	FINISH	/CASE
			INTERIOR	EXTERIOR				
1761	 1-5	265 (120)	48 (1219)	42 (1067)	•	—	AL, DU	10

CAUTION: ANY DOOR CLOSER INSTALLED AND ADJUSTED BASED ON ADA REDUCED FORCE REQUIREMENTS MAY NOT RELIABLY CLOSE AND LATCH DOOR.
 (1) WEIGHT CAPACITY RANGE IN POUNDS (KILOGRAMS) (2) MAXIMUM DOOR WIDTH IN INCHES (MILLIMETRES)

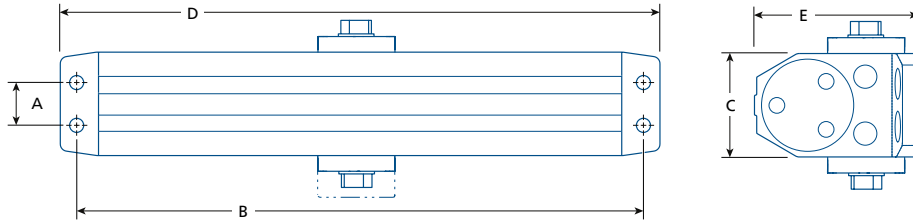

MODEL	A	B	C	D	E
1761	$\frac{3}{4}$ (19)	$9\frac{1}{16}$ (230)	$1\frac{13}{16}$ (46)	$9\frac{9}{16}$ (244.6)	$2\frac{13}{16}$ (71)

IN (MM)





- Certifications**
- Certified ANSI/BHMA A156.4, Grade 1
 - cULus listed, 3hr fire-rating
 - ADA compliant, barrier free
 - 10 Year limited warranty
- Power Size**
- Adjustable size 1-6 (preset 3)
- Body Material**
- Cast aluminum body, painted finish
- Mechanism**
- Hydraulic rack and pinion operation
- Fluid**
- Non-gumming, non-freezing hydraulic fluid
 - Operating range of -15° to 40°C (5° to 104°F)
- Adjustments**
- Sweep speed adjustment valve
 - Latching speed adjustment valve
 - Cushioning backcheck adjustment valve
 - Delayed action adjustment valve - option
- Cover**
- Narrow plastic cover with pinion cap, painted finish
 - Full body plastic cover, painted finish – available

Handing • Non-handed

Opening • 180° maximum

Mounting

- Tri-Pack: regular¹, top jamb¹, parallel arm²
- Maximum reveal: 3" (76 mm)
- Forearm extension³ – available
- Drop plates – available

*(1) Arm shoe allows ±7.5% power adjustment
 (2) May reduce spring power efficiency by 25%
 (3) For reveal up to 4" (101.6 mm)*

Hardware

- Wood screws & self-tapping machine screws
- Sex nuts & thru-bolts – available

Available Arms

- Regular arm, friction hold open
- Heavy duty cushion stop arm, no hold open
- Heavy duty cushion stop arm, hold open
- Heavy duty spring cushion stop arm, no hold open

Finish • AL–Aluminum, painted

Other finishes available by special order

851 BC – AL
 MODEL FINISH

SEE SELECTION GUIDE FOR DETAILS

SELECTION GUIDE

MODEL	POWER SIZE	WEIGHT CAPACITY ¹	MAX. DOOR WIDTH ²		BACKCHECK	DELAYED ACTION	FINISH	/CASE
			INTERIOR	EXTERIOR				
851 BC	1-6	265	54	48	•	—	AL	6
851 BCDA	1-6	(120)	(1372)	(1219)	•	•	AL	6

CAUTION: ANY DOOR CLOSER INSTALLED AND ADJUSTED BASED ON ADA REDUCED FORCE REQUIREMENTS MAY NOT RELIABLY CLOSE AND LATCH DOOR.
 (1) WEIGHT CAPACITY IN POUNDS (KILOGRAMS) (2) MAXIMUM DOOR WIDTH IN INCHES (MILLIMETRES)

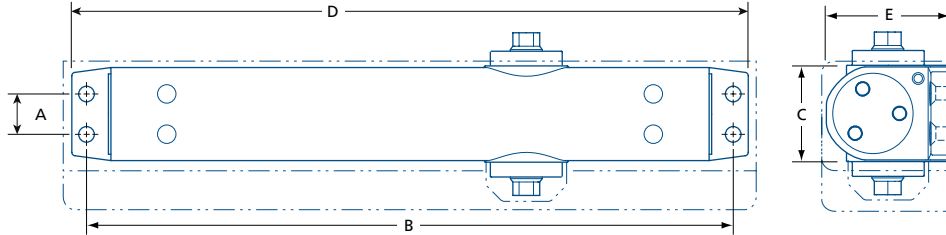

MODEL	A	B	C	D	E
851 WITH NARROW COVER ¹	3/4	11 15/16	1 7/8 (47)	12 3/4 (324)	2 (50.5)
851 WITH FULL BODY COVER ¹	(19)	(303)	3 (76)	13 (330)	2 1/16 (54.5)

IN (MM) (1) PIVOT CAP AND NARROW COVER INCLUDED; FULL BODY COVER SOLD SEPARATELY

PARTS & ACCESSORIES



CSA851
Heavy duty cushion stop arm, hold open. Not for use on fire rated doors.



CSANHO851
Heavy duty cushion stop arm, no hold open.



SCSANHO851
Heavy duty cushion spring stop arm, no hold open.



851-ARMF
Regular arm with adjustable friction hold open. Includes parallel arm bracket. Not for use on fire rated doors.



851-EXT
Long forearm link for reveal up to 4" (102 mm).



FULLCOVER851
Full body plastic cover.
LxWxD: 13 x 3 x 2 1/16" (330 x 76 x 52 mm)



851-DP
For regular installations where the door top rail height is insufficient for direct mounting.



851-DPTJ
For top jamb installations where the door frame header height is insufficient for direct mounting.



851-DPPA
For parallel arm installations where the door top rail height is insufficient for direct mounting.



SNB1420
Aluminum sex nut & steel thru-bolt kit (4) for doors 1 3/4" (44.5 mm) thick.



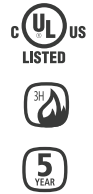

- Certifications**
- cULus listed, 3hr fire-rating
 - 5 Year limited warranty

- Power Size**
- Fixed power size 1,2, 3, 4 or 5
- See selection guide for details*

- Body Material**
- Cast aluminum alloy, painted finish

- Mechanism**
- Hydraulic rack and pinion

- Fluid**
- Non-gumming, non-freezing hydraulic fluid
 - Operating range of -15° to 40°C (5° to 104°F)

- Adjustments**
- Sweep speed valve
 - Latching speed valve
 - Cushioning backcheck valve – option

- Cover**
- Plastic pinion cap, painted finish

- Handing**
- Non-handed

- Opening**
- 180° maximum

- Mounting**
- Tri-Pack: regular¹, top jamb¹, parallel arm²
 - Maximum reveal: 3" (76mm)
 - Drop plates – available

(1) Arm shoe allows ±7.5% power adjustment

(2) May reduce spring power efficiency by 25%

- Hardware**
- Wood & machine screws
 - Sex nuts & thru-bolts – available

- Available Arms**
- Regular arm

- Finish**
- AL–Aluminum, painted; BP–Brass, painted; DU–Dark bronze, painted

Other finishes available by special order

754	AL
MODEL	FINISH

SEE SELECTION GUIDE FOR DETAILS

SELECTION GUIDE

MODEL	POWER SIZE	WEIGHT CAPACITY ¹	MAX. DOOR WIDTH ²		BACKCHECK	DELAYED ACTION	FINISH	/CASE
			INTERIOR	EXTERIOR				
751	1	33–80 (15–36)	32 (813)	—	—	—	AL, BP, DU	10
752	2	55–100 (25–45)	36 (914)	—	—	—	AL, BP, DU	10
753	3	90–145 (40–66)	44 (1118)	—	—	—	AL, BP, DU	10
783					•	—	AL	10
754	4	125–190 (57–86)	48 (1219)	36 (914)	—	—	AL, BP, DU	10
784					•	—	AL, DU	10
755	5	175–265 (80–120)	52 (1321)	44 (1118)	—	—	AL, BP, DU	10
785					•	—	AL, DU	10

CAUTION: ANY DOOR CLOSER INSTALLED AND ADJUSTED BASED ON ADA REDUCED FORCE REQUIREMENTS MAY NOT RELIABLY CLOSE AND LATCH DOOR.
 (1) WEIGHT CAPACITY RANGE IN POUNDS (KILOGRAMS) (2) MAXIMUM DOOR WIDTH IN INCHES (MILLIMETRES)

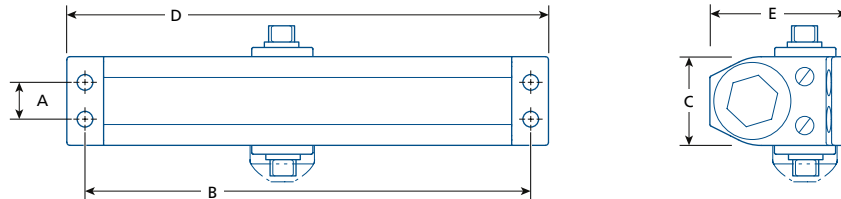

MODEL	A	B	C	D	E
751	¾ (19)	6½ (165)	1 ¹¹ / ₁₆ (43)	7 ¹ / ₈ (181)	2 ⁹ / ₁₆ (65)
752/753 (783)	¾ (19)	8 ³ / ₁₆ (208)	1 ³ / ₄ (45)	8 ⁷ / ₈ (225)	2 ⁷ / ₈ (73)
754/755 (784/785)	¾ (19)	9 ¹ / ₁₆ (230)	1 ³ / ₄ (45)	9 ³ / ₄ (248)	2 ⁷ / ₈ (73)

IN (MM)

PARTS & ACCESSORIES



ARM754
Arm for 752 to 785 door closers.



SNB1420
Aluminum sex nut & steel thru-bolt kit (4) for doors 1³/₄" (44.5 mm) thick.



715
Parallel arm bracket (sizes 1 & 2).



735
Parallel arm bracket (sizes 3, 4 and 5).



DP754
For parallel arm installations where the door top rail height is insufficient for direct mounting (models 754 / 755).



DPN754
Narrow plate for top jamb installations with low ceiling clearance or for regular arm installations where the door top rail height is insufficient for direct mounting.





- Certifications**
- cULus listed, 3hr fire-rating
 - 5 Year limited warranty

- Power Size**
- Fixed power size 2, 3, or 4
- See selection guide for details*

- Body Material**
- Cast aluminum alloy, painted finish

- Mechanism**
- Hydraulic rack and pinion operation

- Fluid**
- Non-gumming, non-freezing hydraulic fluid

- Adjustments**
- Sweep speed valve
 - Latching speed valve

- Cover**
- Plastic pinion cap, painted finish

- Handing**
- Non-handed

- Opening**
- 180° maximum

- Mounting**
- Tri-Pack: regular¹, top jamb¹, parallel arm²
 - Maximum reveal: 1½" (38mm)

*(1) Arm installation allows 15% power adjustment
(2) May reduce spring power efficiency by 25%*

- Hardware**
- Wood screws & self-tapping machine screws
 - Sex nuts & thru-bolts – available

- Available Arms**
- Forearm replacement

- Finish**
- AL–Aluminum, painted

Other finishes available by special order

302	AL
MODEL	FINISH

SEE SELECTION GUIDE FOR DETAILS

SELECTION GUIDE

MODEL	POWER SIZE	WEIGHT CAPACITY ¹	MAX. DOOR WIDTH ²		BACKCHECK	DELAYED ACTION	FINISH	/CASE
			INTERIOR	EXTERIOR				
302	2	55–100 (25–45)	36 (914)	—	—	—	AL	10
303	3	85–140 (38–63)	42 (1067)	—	—	—	AL	10
304	4	125–190 (57–86)	48 (1219)	42 (1067)	—	—	AL	10

CAUTION: ANY DOOR CLOSER INSTALLED AND ADJUSTED BASED ON ADA REDUCED FORCE REQUIREMENTS MAY NOT RELIABLY CLOSE AND LATCH DOOR.
 (1) DOOR WEIGHT CAPACITY RANGE IN POUNDS (KILOGRAMS) (2) MAXIMUM DOOR WIDTH IN INCHES (MILLIMETRES)

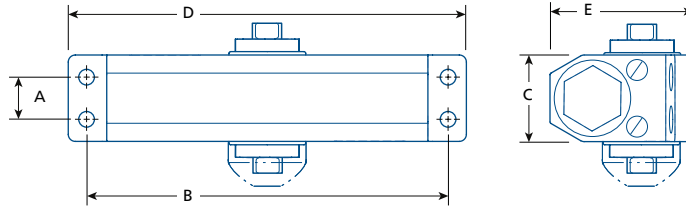

MODEL	A	B	C	D	E
302 / 303 / 304	$\frac{3}{4}$ (19)	$6\frac{3}{8}$ (162)	$1\frac{9}{16}$ (39)	$7\frac{1}{16}$ (180)	$2\frac{9}{16}$ (65)

IN (MM)

PARTS & ACCESSORIES



302-FARM
Replacement forearm for 302/303/304 door closer.



SNB1420
Aluminum sex nut & steel thru-bolt kit (4) for doors $1\frac{3}{4}$ " (44.5 mm) thick.



325
Parallel arm conversion kit.
Not recommended for 302 model.





- Certifications**
- cULus listed, 3hr fire-rating
 - 5 Year limited warranty

- Power Size**
- Fixed power size 3
- See selection guide for details*

- Body Material**
- Cast aluminum alloy, painted finish

- Mechanism**
- Hydraulic rack and pinion operation

- Fluid**
- Non-gumming, non-freezing hydraulic fluid
 - Operating range of -30° to 49°C (-22° to 120°F)

- Adjustments**
- Sweep speed valve
 - Latching speed valve

- Cover**
- Plastic pinion cap, painted finish

- Handing**
- Non-handed

- Opening**
- 180° maximum

- Mounting**
- Regular¹ or top jamb¹
 - Maximum reveal: 3" (76mm)

(1) Arm installation allows +12% power adjustment

- Hardware**
- Wood screws & self-tapping machine screws
 - Sex nuts & thru-bolts – available

- Finish** AL–Aluminum, painted
- Other finishes available by special order*

DC303	AL
MODEL	FINISH

SEE SELECTION GUIDE FOR DETAILS

SELECTION GUIDE

MODEL	POWER SIZE	WEIGHT CAPACITY ¹	MAX. DOOR WIDTH ² INTERIOR EXTERIOR	BACKCHECK	DELAYED ACTION	FINISH	/CASE
DC303	3	< 176 (< 80)	43 (1100)	—	—	AL	10

(1) DOOR WEIGHT CAPACITY RANGE IN POUNDS (KILOGRAMS) (2) MAXIMUM DOOR WIDTH IN INCHES (MILLIMETRES)

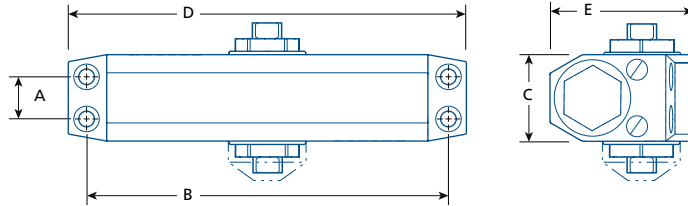

MODEL	A	B	C	D	E
DC303	$\frac{3}{4}$ (19)	$6\frac{3}{8}$ (162)	$1\frac{9}{16}$ (39)	7 (178)	$2\frac{7}{16}$ (62)

IN (MM)

PARTS & ACCESSORIES



SNB1420

Aluminum sex nuts & steel thru-bolt (4) for doors $1\frac{3}{4}$ " (44.5 mm) thick.



TC603 SERIES

DOOR CLOSER



- Certifications**
- cULus listed, 3hr fire-rating
 - 1 Year limited warranty

- Power Size**
- Fixed power size 3

- Body Material**
- Low profile
 - Cast aluminum alloy, painted finish

- Mechanism**
- Hydraulic rack and pinion operation

- Fluid**
- Non-gumming, non-freezing hydraulic fluid
 - Operating range of -30° to 49° C (-22° to 120°F)

- Adjustments**
- Sweep speed valve
 - Latching speed valve

- Cover**
- Aluminum cover plate
 - Plastic pinion cap, painted finish

- Handing**
- Non-handed

- Opening**
- 150° maximum

- Mounting**
- Regular¹ or top jamb¹
 - Parallel arm² bracket – available
 - Maximum reveal: 2½" (63.5 mm)

*(1) Arm installation allows 15% power adjustment
(2) May reduce spring power efficiency by 25%*

- Hardware**
- Wood screws
 - Sex nuts & thru-bolts – available

- Available Arms**
- Sliding arm with optional hold open

- Finish**
- AL–Aluminum; MB–Matte black

Other finishes available by special order

TC603	AL
MODEL	FINISH

SEE SELECTION GUIDE FOR DETAILS

SELECTION GUIDE

MODEL	POWER SIZE	WEIGHT CAPACITY ¹	MAX. DOOR WIDTH ² INTERIOR EXTERIOR	BACKCHECK	DELAYED ACTION	FINISH	/CASE
TC603	3	55–143 (25–65)	36 (914)	—	—	AL, MB	10

CAUTION: INSTALLATION POSITION WILL AFFECT THE FINAL CLOSING FORCE BETWEEN 1 AND 3 - SEE INSTALLATION INSTRUCTIONS FOR DETAILS.
(1) DOOR WEIGHT CAPACITY RANGE IN POUNDS (KILOGRAMS) (2) MAXIMUM DOOR WIDTH IN INCHES (MILLIMETRES)

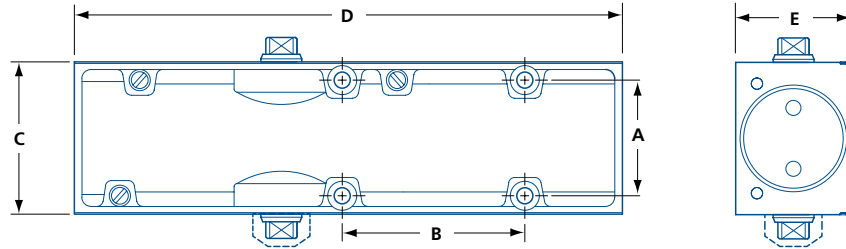

MODEL	A	B	C	D	E
TC603	1 1/2 (38)	2 3/8 (60)	2 (51)	7 1/8 (184)	1 9/16 (39)

IN (MM)

PARTS & ACCESSORIES



TC603-SA
Sliding arm with optional hold open. 120° opening. Not for use on fire rated doors. Available aluminum (AL) or matte black (MB).



TC603-PB
Parallel arm bracket for TC603.



SNB1420
Aluminum sex nuts & steel thru-bolt (4) for doors 1 3/4" (44.5 mm) thick.





- Certifications**
- cULus listed, 3hr fire-rating
 - 5 Year limited warranty

- Power Size**
- Fixed power size 3

- Body Material**
- Cast aluminum body, painted finish

- Mechanism**
- Hydraulic rack and pinion operation

- Fluid**
- Non-gumming, non-freezing hydraulic fluid
 - Operating range of -30° to 49° C (-22° to 120° F)

- Adjustments**
- Sweep speed adjustment valve
 - Latching speed adjustment valve

Cover —

- Handing**
- Non-handed

- Opening**
- 100° maximum (ehold open)
 - 120° maximum (no hold open)

- Door Type**
- For interior wood or hollow metal doors over 1¾" (44.5 mm) thick
 - Door must be hung using butt or pivot hinges

- Mounting**
- Installs in to top of door
 - Can be installed in door frame

- Hardware**
- Wood & machine screws

- Arm**
- Sliding arm , surface mounted, with adjustable hold open*

(*) Not to be used on fire rated doors

- Finish** AL—Aluminum, painted
Other finishes available by special order

DC3033	AL
MODEL	FINISH

SELECTION GUIDE

MODEL	POWER SIZE	WEIGHT CAPACITY ¹	MAX. DOOR WIDTH ²	BACKCHECK	DELAYED ACTION	FINISH	/CASE
DC3033	3	88-144 (40-65)	36 (914)	—	—	AL	10

(1) RECOMMENDED DOOR WEIGHT CAPACITY RANGE IN POUNDS (KILOGRAMS) (2) RECOMMENDED MAXIMUM DOOR WIDTH IN INCHES (MILLIMETRES)

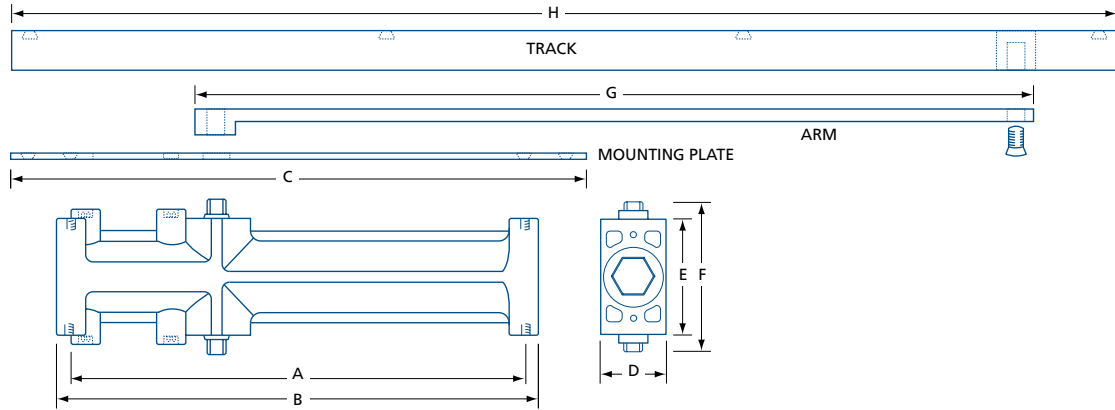

MODEL	A	B	C	D	E	F	G	H
DC3033	$8\frac{5}{8}$ (219)	$9\frac{1}{16}$ (230)	$10\frac{15}{16}$ (275)	$1\frac{1}{4}$ (32)	$2\frac{7}{32}$ (56)	$2\frac{7}{8}$ (72)	$14\frac{1}{2}$ (368)	$18\frac{1}{8}$ (460)

IN (MM)





- Certifications**
- EN1154 compliant for 500,000 cycles
 - 5 Year limited warranty

- Models**
- Light duty
 - Regular duty
 - Heavy duty

See selection guide for details

- Body Material**
- Compact cast steel body, painted finish

- Mechanism**
- Hydraulic, dual spring operation

- Fluid**
- Non-gumming, non-freezing hydraulic fluid
 - Operating range of -15° to 40°C (5° to 104°F)

- Adjustments**
- Sweep speed adjustment valve
 - Latching speed adjustment valve

Cover —

- Handing**
- Non-handed

- Opening**
- 90° maximum
 - 105° maximum – available
 - Mechanical hold open – available

See selection guide for details

- Door Types**
- Suitable for wood, metal or aluminum framed doors over 1¾" (44.5 mm) thick
 - Suitable for frame-less tempered glass doors up to ½" (13 mm) thick (patch fittings sold separately)

- Mounting**
- Universal single, double acting or centre-hung applications
 - Fits 1¾ x 4" (45 x 102 mm) header sections
- Interchangeable with JACKSON™ door closers*

- Hardware**
- Machine and wood screws
 - Mounting anchors

- Arms & Pivots**
- Side loading top arm
 - End loading top arm –option
 - Offset arm and channel –available
 - 18–20 mm channel depth pivot
 - 18–57 mm channel depth pivot –option

Finish —

30	RD	90	HO
MODEL	DUTY	OPENING	OPTION

HO-HOLD OPEN; NHO-NO HOLD OPEN
SEE SELECTION GUIDE FOR DETAILS

SELECTION GUIDE

MODEL	DESCRIPTION	MAXIMUM OPENING	OPTION ¹	WEIGHT CAPACITY ²	MAXIMUM DOOR SIZE ³	CLOSING FORCE Nm ⁴
30LD90	Light duty, bottom pivot, and side loading arm assembly.	90°	NHO	225 (100)	30x96 (732x2438)	13–18
30LD105		105°				
30RD90	Regular duty, bottom pivot, and side loading arm assembly. Available body-only (30B*)	90°	NHO, HO	225 (100)	42x96 (1067x2438)	18–26
30RD105		105°				
31RD90	Regular duty, 17 mm spindle, bottom pivot, and end loading arm assembly. Available body-only (31B*†)	90°	NHO, HO	225 (100)	42x96 (1067x2438)	18–26
31RD105		105°				
30HD90	Heavy duty, bottom pivot, and side loading arm assembly.	90°	NHO, HO	225 (100)	48x96 (1219x2438)	26–37
30HD105		105°				
31HD105	Heavy duty, 17 mm spindle, bottom pivot, and end loading arm assembly.	105°	NHO			

(1) NHO—NO HOLD OPEN; HO—HOLD OPEN (2) MAXIMUM DOOR WEIGHT IN POUNDS (KILOGRAMS). (3) MAXIMUM DOOR SIZE W X H IN INCHES (MILLIMETRES). (4) NOMINAL VALUES PROVIDED; MAY VARY WITH INSTALLATION. (*) SPECIAL ORDER. ARM, PIVOT, ANCHORS & MOUNTING HARDWARE NOT INCLUDED. (†) RECOMMENDED FOR FRAME-LESS TEMPERED GLASS DOOR APPLICATIONS.

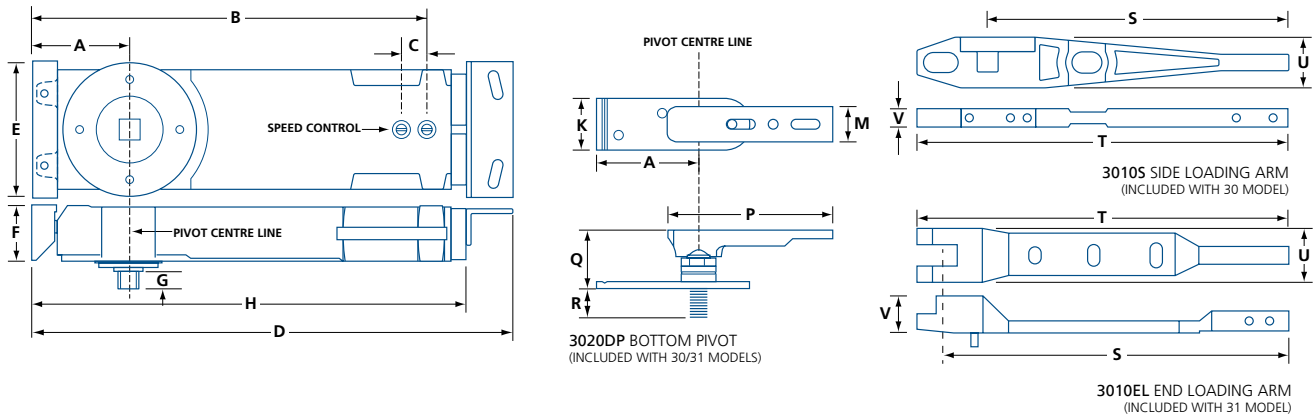

MODEL	A	B	C	D	E	F	G	H	K	M	P	Q	R	S	T	U	V
30	2¾ (70)	10¾ (273)	1¼ (17.5)	12¾ (324)	3¼ (94)	1½ (38)	½ (12.7)	11¾ (298)	1⅜ (35)	3¼ (24)	4⅞ (113)	1½–2¼ (38–57)	0–¾ (0–19)	8⅞ (206)	10 (254)	1⅜ (35)	1⅞ (13)
31							2¼ (17)							8¼ (220)	9⅞ (240)		1 (25.4)

IN (MM)

PARTS & ACCESSORIES



3010S
Type “S” side loading arm assembly. Included with model 30.



3010OC
Offset arm and channel.



3010EL
Type “A” end loading arm for 1” (25.4mm) deep web. Included with model 31.



3010DP
Bottom pivot set (125 lbs / 56.8 kg max.), 18– 57 mm channel depth.



3010AMC
Anchor set. Included with 30 and 31 models.



3020DP
Bottom pivot set (125 lbs / 56.8 kg max.), 18– 20 mm channel depth. Included with 30 and 31 models.





Certifications • 5 Year limited warranty

- Models**
- Regular duty
 - Heavy duty

See selection guide for details

Body Material • Compact cast steel body, painted finish

Mechanism • Hydraulic, dual spring operation

- Fluid**
- Non-gumming, non-freezing hydraulic fluid
 - Operating range of -15° to 40°C (5° to 104°F)

- Adjustments**
- Sweep speed adjustment valve
 - Latching speed adjustment valve

Cover • Stainless steel cover plate, satin finish

Handing • Non-handed

- Opening**
- 90° maximum
 - 105° maximum – available
 - 130° maximum – available
 - Mechanical hold open – available

See selection guide for details

- Door Type**
- Suitable for wood, metal or aluminum framed doors over 1¾" (44.5 mm) thick
 - Suitable for frame-less tempered glass doors up to ½" (13 mm) thick (patch fittings sold separately)

- Mounting**
- Universal single, double acting or centre-hung applications
 - 1⅝" (41.3 mm) installation depth
 - Ideal for thin slab installations
- Interchangeable with JACKSON door closers*

- Hardware**
- Steel floor casing; 1⅝" (41.3 mm) installation depth
 - Required bolts, brackets and screws for casing installation

Finish C32D–Satin stainless steel
COVER PLATE ONLY
Other finishes available by special order

40B	RD	90	HO	–	RS
MODEL	DUTY	OPENING	OPTION		OPTION

HO-HOLD OPEN; NHO-NO HOLD OPEN; RS-REMOVABLE SPINDLE
SEE SELECTION GUIDE FOR DETAILS

SELECTION GUIDE

MODEL	DESCRIPTION	MAXIMUM OPENING	OPTION ¹	WEIGHT CAPACITY ²	MAXIMUM DOOR SIZE ³	CLOSING FORCE Nm ⁴
40 RD90	Regular duty, with bottom arm and top pivot assembly. Stainless steel cover included.	90°	HO	225 (100)	36x96 (914x2438)	18–26
40 RD105		105°				
40 RD130		130°				
40B RD90 -RS	Regular duty, body only, with removable 15 mm pivot with 3 mm extension.*	90°	HO	225 (100)	36x96 (914x2438)	18–26
40B RD130 -RS		130°	NHO			
40 HD90	Heavy duty, with bottom arm and top pivot assembly. Stainless steel cover included.	90°	HO	225 (100)	42x96 (1067x2438)	26–37
40 HD105		105°				
40 HD130		130°				

(1) NHO—NO HOLD OPEN; HO—HOLD OPEN (2) MAXIMUM DOOR WEIGHT IN POUNDS (KILOGRAMS). (3) MAXIMUM DOOR SIZE WXH IN INCHES (MILLIMETRES).

(4) NOMINAL VALUES PROVIDED; MAY VARY WITH INSTALLATION.

(*) RECOMMENDED FOR FRAME-LESS TEMPERED GLASS DOOR APPLICATIONS. CEMENT CASE, COVER & MOUNTING HARDWARE NOT INCLUDED. OTHER PIVOTS SOLD SEPARATELY.

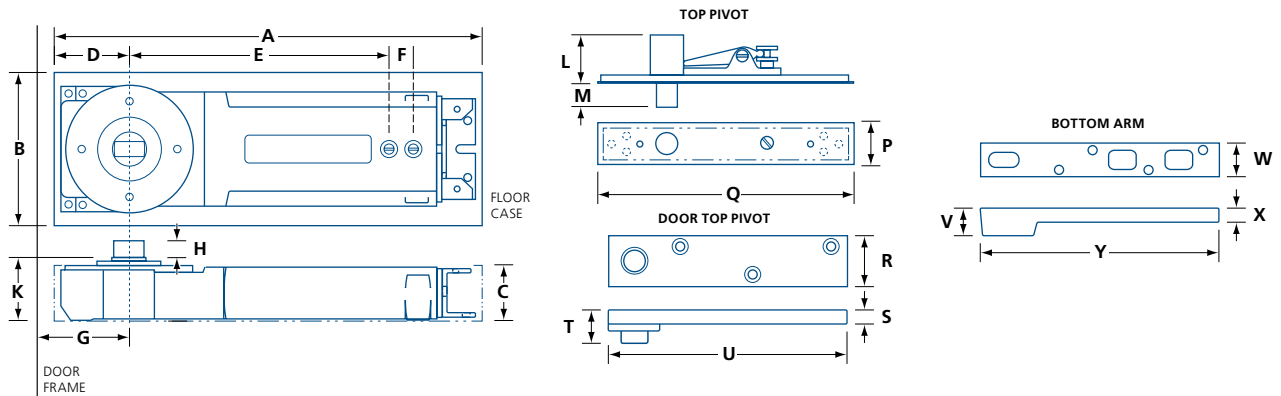

MODEL	A	B	C	D	E	F	G	H	K	L	M	P	Q	R	S	T	U	V	W	X	Y
40	12 ¹ / ₈ (308)	4 ¹ / ₄ (108)	1 ¹ / ₁₆ (40)	2 ¹ / ₈ (54)	7 ¹ / ₄ (184)	2 ³ / ₃₂ (18)	2 ³ / ₄ (70)	9 ¹ / ₁₆ (15)	1 ³¹ / ₃₂ (50)	1 ³ / ₈ (35)	2 ³ / ₃₂ (18.5)	1 ³ / ₁₆ (30)	6 ⁷ / ₈ (175)	1 ¹ / ₄ (32)	1 ⁵ / ₆₄ (6)	2 ⁵ / ₃₂ (20)	5 ²⁹ / ₃₂ (150)	1 ³ / ₁₆ (13)	1 ⁵ / ₁₆ (24)	7 ¹ / ₁₆ (11)	6 ⁵ / ₈ (168)

IN (MM)

PARTS & ACCESSORIES



40ESP-3
Removable 15 mm pivot, 3 mm extension.
Included with #40B.



40CP
Cover plate.
#40CPC3: Polished brass
#40CPC32D: Satin stainless steel



40ESP-5
Removable 15 mm pivot, 5 mm extension.
Dimension K is 55 mm when installed.



40ESP-10
Removable 15 mm pivot, 10 mm extension.
Dimension K is 60 mm when installed.



40ESP-15
Removable 15 mm pivot, 15 mm extension.
Dimension K is 65 mm when installed.



CONCEALED SPRING CLOSERS

SPECIALTY DOOR CLOSERS



CONCEALED SPRING CLOSER

PERKO



PERKO



ROUND CORNER MODEL
AVAILABLE BY SPECIAL ORDER

- cULus Listed for use on wood fire doors rated up to 30 minutes
- Concealed in door
- Suitable for interior doors up to 110 lbs (50 kg)
- Fits doors 1 $\frac{3}{8}$ –1 $\frac{3}{4}$ " (35–44.5 mm) thick
- Door opening depends on door thickness and hinge size - up to a maximum of 98°
- Not recommended for use on doors fitted with concealed hinges
- Adjustable spring power
- Non-handed
- Endurance tested for 500,000 cycles
- Available with round or square faceplates

Available in a variety of finishes. Please contact us to order.
Visit www.perkopower.com for product details.

PERKO	-	SCP
MODEL		FINISH

PLEASE CONTACT FOR SELECTION HELP



CONCEALED SPRING CLOSER – EXTENDED

PERKO-L, PERKO-LS



PERKO-L



PERKO-LS

- cULus Listed for use on wood fire doors rated up to 30 minutes
- Concealed in door
- Suitable for interior doors up to 110 lbs (50 kg) hung using standard hinges
- Fits doors 1 $\frac{3}{8}$ –1 $\frac{3}{4}$ " (35–44.5 mm) thick
- Door opening depends on door thickness and hinge size - up to a maximum of 180°
- Not recommended for use on doors fitted with concealed hinges
- Adjustable spring power
- Non-handed
- Endurance tested for 500,000 cycles
- Available with round or square faceplates

Available in a variety of finishes. Please contact us to order.
Visit www.perkopower.com for product details.

PERKO	-	LS	-	SCP
MODEL		TYPE		FINISH

PLEASE CONTACT FOR SELECTION HELP

CONCEALED SPRING CLOSERS

SPECIALTY DOOR CLOSERS



PERKOMATIC CONCEALED SPRING CLOSER

PERKOMATIC



- cULus Listed for use on wood fire doors rated up to 30 minutes
- Concealed in door
- Suitable for interior doors up to 165 lbs (75 kg)
- Fits doors 1¾" (44.5 mm) thick
- Door opening depends on installation - up to a maximum of 180°
- Not recommended for use on doors fitted with parliament (butterfly), concealed, projecting or rising butt hinges
- Adjustable latching speed
- Non-handed
- Endurance tested for 500,000 cycles

Available in a variety of finishes. Please contact us to order.
Visit www.perkopower.com for product details.

PERKOMATIC	-	C26D
MODEL		FINISH

PLEASE CONTACT FOR SELECTION HELP



POWERMATIC CONCEALED HYDRAULIC CLOSER

POWERMATIC



- cULus Listed for use on wood fire doors rated up to 45 minutes with intumescent mastic; up to 3 hours on metal doors
- Conforms to ANSI/BHMA 156.4 requirements
- Conforms to ADA maximum force requirements
- Concealed in door
- Suitable for latching and non-latching applications
- Suitable for doors up to 175 lbs (80 kg) and 37½" (950 mm) wide
- Fits doors 1¼–1¾" (32–44.5 mm) thick
- Door opening depends on installation - up to a maximum of 105°
- Not recommended for use on doors fitted with concealed hinges
- Adjustable latching and closing speed
- Non-handed
- Endurance tested for 500,000 cycles

Available in a variety of finishes. Please contact us to order.
Visit www.perkopower.com for product details.

POWERMATIC	-	C26D
MODEL		FINISH

PLEASE CONTACT FOR SELECTION HELP



PF100 SERIES

HYDRAULIC PATCH FITTING CLOSER



1
YEAR

-
- Certifications** • 1 Year limited warranty
- Panel Thickness** • $\frac{5}{16}$ – $\frac{1}{2}$ " (8–12.7 mm)
- Max. Door Width** • $39\frac{3}{8}$ " (1000 mm)
- Max. Door Weight** • 220 lbs (100 kg)
- Max. Door Height** • For $\frac{5}{16}$ " (8 mm) glass: 84" (2134 mm)
• For $\frac{1}{2}$ " (12.7 mm) glass: 108" (2743 mm)
Recommended height. Please consult glass door manufacturer for more details.
- Body Material** • Machined aluminum
- Mechanism** • Hydraulic spring
- Fluid** • All weather hydraulic fluid
• Operating range of -20° to 49°C (-4° to 120°F)
- Adjustments** • Sweep speed adjustment
• Latching speed adjustment
• Door adjustments:
» Vertical / horizontal: $\pm\frac{1}{8}$ " (3 mm)
» CW /CCW: $\pm 4^\circ$
- Cover** • Stainless steel or aluminum* pinned cover
() When ordering aluminum (628) finish*
- Handing** • Non-handed
- Opening** • Double acting
• 150° maximum
• 90° hold open – option
- Mounting** • Floor surface mounted
- Hardware** • Screws and masonry anchors
- Finish** 628–Aluminum; 629–Polished stainless steel;
630–Satin stainless steel, 19–Matte black

PF100DC – 630

MODEL FINISH

SEE SELECTION GUIDE FOR DETAILS

SELECTION GUIDE

MODEL	WEIGHT CAPACITY ¹	MAX. DOOR WIDTH ²		MAX. DOOR HEIGHT ³	BACKCHECK	HOLD OPEN	FINISH
		INTERIOR	EXTERIOR				
PF100DC	220	39	—	84 or 108	—	—	628, 629
PF100DCHO	(100)	(1000)	—	(2134 or 2743)	—	●	630,19

(1) DOOR WEIGHT CAPACITY RANGE IN POUNDS (KILOGRAMS) (2) MAXIMUM DOOR WIDTH IN INCHES (MILLIMETRES)
 (3) FOR 5/16" (8MM) GLASS THICKNESS DO NOT EXCEED 84" (2134MM)

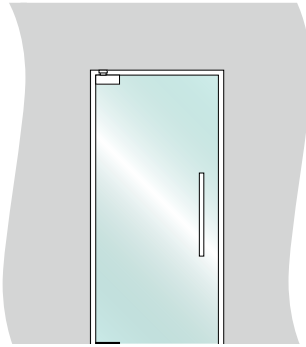

DOOR CLOSER
PF100DC / DCHO

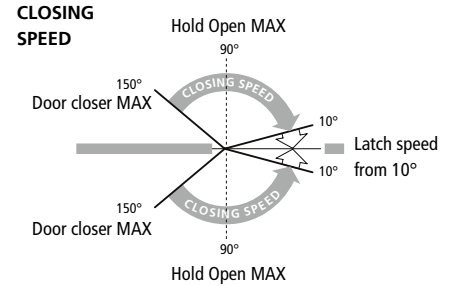
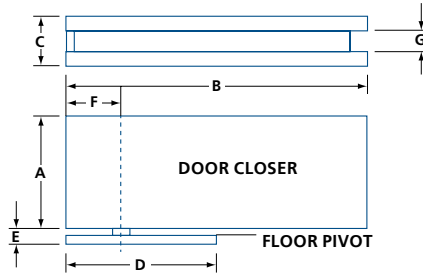

MODEL	A	B	C	D	E	F	G
PF100DC	2 ¹³ / ₁₆	7 ³ / ₁₆	1 ⁹ / ₁₆	4 ³ / ₈	1/2	2 ¹ / ₈	5 ¹ / ₁₆ to 1/2
PF100DCHO	(71.5)	(183)	(40)	(111)	(12.7)	(54)	(8 to 12.7)

IN (MM)

PARTS & ACCESSORIES



PF121
Top door patch fitting with extended covers. Available in matching finishes. See 04.400 for other glass patch fittings.



PF120TP1
Top pivot, surface mounted. Available in matte black (19) finish.



PF120TP2
Top walking pivot. Mortised, with adjustable pivot.



PF165CM
Ceiling mounted door stop. Cast stainless steel. Includes mounting screws and plastic anchors.



PF100DC-SD3 / PF100DCHO-SD3
Complete glass door kit. Includes PF100DC or PF100DCHO with PF121 and PF120TP1 in matching finishes.



Patch Fitting Door Locks
See 01.500 for a complete list of available patch fitting door locks.



Architectural Door Pulls
See 06.010 for a complete list of available architectural stainless steel door pulls.

Including:
 – Mitered door pulls
 – Ladder type door pulls
 – Offset door pulls



PF102 SERIES

HYDRAULIC PATCH FITTING CLOSER



1
YEAR

- Certifications** • 1 Year limited warranty
- Panel Thickness** • $\frac{5}{16}$ – $\frac{1}{2}$ " (8–12.7 mm)
- Max. Door Width** • 39" (1000 mm)
- Max. Door Weight** • 220 lbs (100 kg)
- Max. Door Height** • For $\frac{5}{16}$ " (8 mm) glass: 84" (2134 mm)
• For $\frac{1}{2}$ " (12.7 mm) glass: 108" (2743 mm)
Recommended height. Please consult glass door manufacturer for more details.
- Body Material** • Machined aluminum
- Mechanism** • Hydraulic spring
- Fluid** • All weather hydraulic fluid
• Operating range of -20° to 40°C (-4° to 104°F)
- Adjustments** • Sweep speed adjustment
• Latching speed adjustment
• Door adjustments:
» Vertical / horizontal: $\pm \frac{1}{32}$ " (1 mm)
» CW /CCW: $\pm 2^\circ$
- Cover** • Stainless steel snap-on cover
- Handing** • Non-handed
- Opening** • Double acting
• 170° Maximum
• 90° Hold open – option
- Mounting** • Floor surface mounted
- Hardware** • Screws and masonry anchors
- Finish** 630–Satin stainless steel; 19–Matte black*
() Special order–may require additional lead time and/or minimum order quantities*

PF102DC – 630

MODEL FINISH

SEE SELECTION GUIDE FOR DETAILS

SELECTION GUIDE

MODEL	WEIGHT CAPACITY ¹	MAX. DOOR WIDTH ²		MAX. DOOR HEIGHT ³	BACKCHECK	HOLD OPEN	FINISH
		INTERIOR	EXTERIOR				
PF102DC	220	39	—	84 or 108	—	—	630, 19*
PF102DCHO	(100)	(1000)	—	(2134 or 2743)	—	●	

(1) DOOR WEIGHT CAPACITY RANGE IN POUNDS (KILOGRAMS) (2) MAXIMUM DOOR WIDTH IN INCHES (MILLIMETRES)
 (3) FOR 5/16" (8MM) GLASS THICKNESS DO NOT EXCEED 84" (2134MM) (*SPECIAL ORDER FINISH

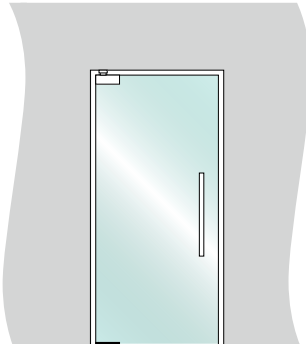

DOOR CLOSER
PF102DC / DCHO

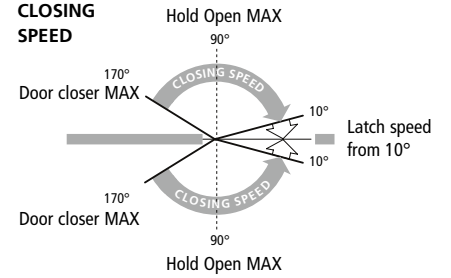
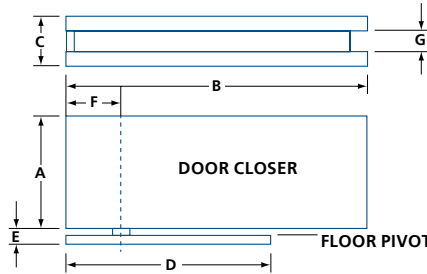

MODEL	A	B	C	D	E	F	G
PF102DC	2 ³ / ₄	7 ³ / ₁₆	1 ²¹ / ₃₂	4 ⁷ / ₈	1/2	2 ⁵ / ₁₆	1 ¹³ / ₃₂ to 1/2
PF102DCHO	(70)	(182)	(42)	(124)	(12.7)	(58)	(10 to 13)

IN (MM)

PARTS & ACCESSORIES



PF121
Top door patch fitting with extended covers. Available in matching finishes. See 04.400 for other glass patch fittings.



Patch Fitting Door Locks
See 01.500 for a complete list of available patch fitting door locks.



PF120TP1
Top pivot, surface mounted. Available in matte black (19) finish.



PF120TP2
Top walking pivot. Mortised, with adjustable pivot.



PF165CM
Ceiling mounted door stop. Cast stainless steel. Includes mounting screws and plastic anchors.



Architectural Door Pulls
See 06.010 for a complete list of available architectural stainless steel door pulls.

Including:
 - Mitered door pulls
 - Ladder type door pulls
 - Offset door pulls



AUXILIARY DOOR CLOSER

DOOR CHECK

DC500 SILENT DOOR CHECK

DC500



- For interior doors or walk-in freezer doors between 44–77 lbs (20–35 kg)
- 10 lbs (4.5 kg) closing force
- Non-handed
- Silent hydraulic mechanism
- Operating range of -10° to 40°C (14° to 104°F)
- Slows closing between 0° and 10°, preventing door slamming
- Surface mounted
- Includes standard hook for standard applications
- Other hooks available (sold separately)
 - #HH500: high hook for protruding door
 - #LH500: low hook for recessed door
- Mounting hardware included

DC500
MODEL

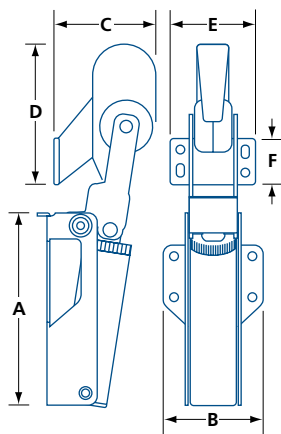

STANDARD HOOK FOR STANDARD DOORS

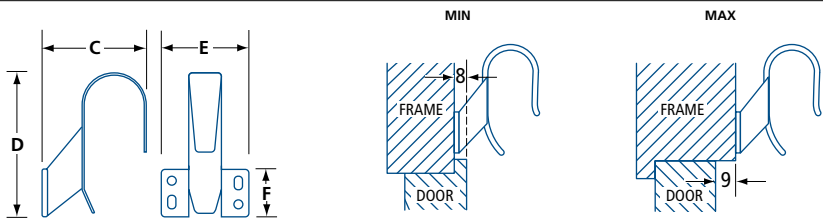

HIGH HOOK FOR PROTRUDING DOORS (HH500)

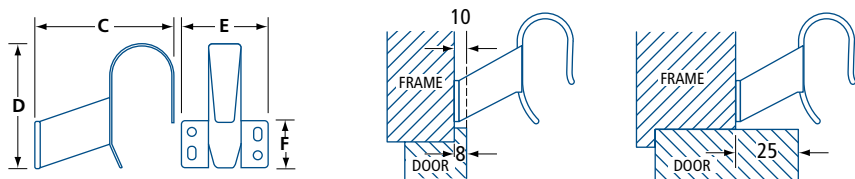

LOW HOOK FOR RECESSED DOORS (LH500)

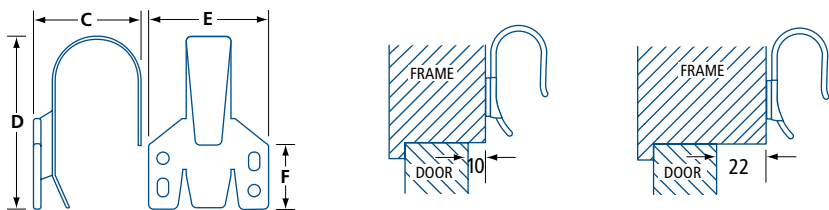

HH500
High Hook



LH500
Low Hook

MODEL	A	B	C	D	E	F
DC500	4 ³ / ₁₆ (106)	2 ⁷ / ₃₂ (56)	2 ⁷ / ₁₆ (62)	2 ³ / ₄ (70)	1 ⁷ / ₈ (48)	1 (25.4)
HH500*	—	—	3 ³ / ₁₆ (81)	2 ³ / ₄ (70)	1 ⁷ / ₈ (48)	1 (25.4)
LH500*	—	—	1 ¹¹ / ₁₆ (43.2)	2 ³ / ₄ (70)	1 ⁷ / ₈ (48)	1 (25.4)

IN (MM) (*)LOW AND HIGH HOOKS SOLD SEPARATELY

OVERHEAD STOPS & HOLDERS

CONCEALED MOUNT

ABH CONCEALED OVERHEAD STOP/HOLDER – HEAVY DUTY

ABH-1000



- UL Listed for use on wood fire doors rated up to 90 minutes and metal fire doors rated up to 3 hours (Stop Function Only)
- Concealed mount, heavy duty
- For Interior or exterior use on frequent traffic and heavy weight doors
- 1¾" (44.5 mm) minimum door thickness
- Stop, hold-open and friction functions available
- Single or Double acting doors
- Non-handed
- Standard installation from 85° to 110° of opening (5° increments)
- Shock absorbing spring provides 3° to 5° cushion before dead-stop

Available in a variety of finishes, models, options, and lengths. Please contact us to order. Visit www.abhmfg.com for product or warranty details (coverage may vary by region).

ABH-10	22	-32D
MODEL	TYPE	FINISH

PLEASE CONTACT FOR SELECTION HELP

ABH ADJUSTABLE CONCEALED OVERHEAD STOP/HOLDER – HEAVY DUTY

ABH-1000A



- UL Listed for use on wood fire doors rated up to 90 minutes and metal fire doors rated up to 3 hours (Stop Function Only)
- Concealed mount, heavy duty
- For Interior or exterior use on frequent traffic and heavy weight doors
- 1¾" (44.5 mm) minimum door thickness
- Stop, hold-open and friction functions available
- Single acting doors only
- Non-handed
- Degree of opening is field-adjustable after installation from 85° to 110° (5° increments)
- Shock absorbing spring provides 3° to 5° cushion before dead-stop

Available in a variety of finishes, models, options, and lengths. Please contact us to order. Visit www.abhmfg.com for product or warranty details (coverage may vary by region).

ABH-10	12	A	-32D
MODEL	TYPE		FINISH

PLEASE CONTACT FOR SELECTION HELP

OVERHEAD STOPS AND HOLDERS

CONCEALED MOUNT

ABH CONCEALED OVERHEAD STOP/HOLDER - SLIM LINE

ABH-1000SL



- UL Listed for use on wood fire doors rated up to 90 minutes and metal fire doors rated up to 3 hours (Stop Function Only)
- Concealed mount, heavy duty
- Slim line channel designed for aluminum store front doors
- For interior or exterior use on frequent traffic and heavy weight doors
- 1¾" (44.5 mm) minimum door thickness
- Stop and hold-open functions available
- Single or Double acting doors
- Non-handed
- Standard installation from 85° to 110° of opening (5° increments)
- Shock absorbing spring provides 3° to 5° cushion before dead-stop

Available in a variety of finishes, models, options, and lengths. Please contact us to order. Visit www.abhmfg.com for product or warranty details (coverage may vary by region).

ABH-10	12	SL	-32D
MODEL	TYPE	FINISH	

PLEASE CONTACT FOR SELECTION HELP

ABH CONCEALED OVERHEAD STOP/HOLDER - MEDIUM DUTY

ABH-4000



- UL Listed for use on wood fire doors rated up to 90 minutes and metal fire doors rated up to 3 hours (Stop Function Only)
- Concealed mount, medium duty
- For interior or exterior use on moderate traffic and medium weight doors
- 1¾" (35 mm) minimum door thickness
- Stop, hold-open and friction functions available
- Single or Double acting doors
- Non-handed
- Standard installation from 85° to 110° of opening (5° increments)
- Shock absorbing spring provides 3° to 5° cushion before dead-stop

Available in a variety of finishes, models, options, and lengths. Please contact us to order. Visit www.abhmfg.com for product or warranty details (coverage may vary by region).

ABH-40	24	-32D
MODEL	TYPE	FINISH

PLEASE CONTACT FOR SELECTION HELP



OVERHEAD STOPS & HOLDERS

SURFACE MOUNT

ABH OVERHEAD STOP/HOLDER – HEAVY DUTY

ABH-9000



- UL Listed for use on wood fire doors rated up to 90 minutes and metal fire doors rated up to 3 hours (Stop Function Only)
- Surface mount, heavy duty
- For Interior or exterior use on frequent traffic and heavy weight doors
- Standard fasteners supplied with sex bolts for 1¾–2¼" (44.5–57 mm) thick door (contact for other door thickness)
- Stop, hold-open and friction functions available
- Single acting doors only
- Non-handed
- Standard installation from 85° to 110° of opening (5° increments)
- Shock absorbing spring provides 3° to 5° cushion before dead-stop

Available in a variety of finishes, models, options, and lengths. Please contact us to order. Visit www.abhmfg.com for product or warranty details (coverage may vary by region).

ABH-90	22	-32D
MODEL	TYPE	FINISH

PLEASE CONTACT FOR SELECTION HELP

ABH OVERHEAD STOP/HOLDER – MEDIUM DUTY

ABH-4400



- UL Listed for use on wood fire doors rated up to 90 minutes and metal fire doors rated up to 3 hours (Stop Function Only)
- Surface mount, medium duty
- For Interior or exterior use on frequent traffic and heavy weight doors
- Standard fasteners supplied with sex bolts for 1¾–1⅞" (44.5–47.6 mm) thick door (contact for other door thickness)
- Stop, hold-open and friction functions available
- Single acting doors only
- Non-handed
- Standard installation from 85° to 110° of opening (5° increments)
- Shock absorbing spring provides 3° to 5° cushion before dead-stop

Available in a variety of finishes, models, options, and lengths. Please contact us to order. Visit www.abhmfg.com for product or warranty details (coverage may vary by region).

ABH-44	32	-32D
MODEL	TYPE	FINISH

PLEASE CONTACT FOR SELECTION HELP

OVERHEAD STOPS AND HOLDERS

SURFACE MOUNT

ABH ADJUSTABLE OVERHEAD STOP/HOLDER - MEDIUM DUTY

ABH-3300A



- UL Listed for use on wood fire doors rated up to 90 minutes and metal fire doors rated up to 3 hours (Stop Function Only)
- Surface mount, medium duty
- For Interior or exterior use on moderate traffic and medium weight doors
- Standard fasteners supplied with sex bolts for 1 $\frac{3}{4}$ –1 $\frac{7}{8}$ " (44.5–47.6mm) thick door (contact for other door thickness)
- Stop, hold-open and friction functions available
- Single acting doors only
- Non-handed
- Degree of opening is field adjustable from 85° to 110° (5° increments)
- Shock absorbing spring provides 3° to 5° cushion before dead-stop

Available in a variety of finishes, models, options, and lengths. Please contact us to order. Visit www.abhmfg.com for product or warranty details (coverage may vary by region).

ABH-33	23	A	-32D
MODEL	TYPE	FINISH	

PLEASE CONTACT FOR SELECTION HELP



DOOR COORDINATORS

SURFACE MOUNT

DOOR COORDINATOR – SURFACE MOUNTED

DCM, DCFB, DCMB



- UL listed fire door coordinator
- Use on paired doors (with astragal) to allow inactive door to close before active door
- Non-handed
- Surface mounted
- Aluminum extrusion with steel components
- Active door holding lever with adjustable tension
- Mounting hardware included: machine screws
- Anodized aluminum finish (28)
- Filler bars – available
- Mounting brackets for other components – available

DCSM	42	28
MODEL	SIZE	FINISH

SIZE	LENGTH	USAGE
32	32 (813)	For openings 34–52" (864–1320mm) or a pair of 24" (610mm) doors
42	42 (1067)	For openings 52–72" (1320–1829mm) or a pair of 30" (762mm) doors
52	52 (1320)	For openings 62–92" (1575–2337mm) or a pair of 36" (914mm) doors
60	60 (1524)	For openings 70–108" (1778–2743mm) or a pair of 42" (1067mm) doors

IN (MM)

MOUNTING BRACKETS*



DCMB4250

- Allows other components to be installed over door coordinator
- Use with door frames with a door stop height of $\frac{5}{8}$ " (16mm) and a minimum door stop width of $2\frac{1}{2}$ " (64mm)
- Sold individually

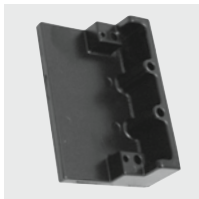

DCMB4750

- Allows other components to be installed over door coordinator
- Use with door frames with a door stop height of $\frac{5}{8}$ " (16mm) and a door stop width between $\frac{7}{8}$ – $2\frac{1}{4}$ " (22–57mm)
- Sold individually

(*) Mounting bracket can not be used in fire rated door openings.

FILLER BARS



DCFB

- DCSM coordinators do not always cover entire length of door stop. Filler bars are used maintain a clean aesthetic look.
- Aluminum extrusion, anodized finish (28)

ITEM	DIMENSIONS*
DCFB18-28	18 x $1\frac{5}{8}$ x $\frac{5}{8}$ (457 x 41 x 16)
DCFB32-28	32 x $1\frac{5}{8}$ x $\frac{5}{8}$ (813 x 41 x 16)
DCFB42-28	42 x $1\frac{5}{8}$ x $\frac{5}{8}$ (1067 x 41 x 16)

IN (MM) (*) LENGTH X WIDTH X HEIGHT

DOOR COORDINATORS

SURFACE MOUNT

GRAVITY DOOR COORDINATOR

DCG7, DCG9



- UL listed for fire doors, conforms to ANSI/BHMA 156.3 type 21
- For use on paired doors with astragal up to 4" (102 mm) to allow inactive door to close before active door
- Non-handed
- Surface mounted
- Solid brass, satin chrome finish
- Nylon and rubber rollers and strike plate provide quiet and efficient operation and help protect the doors from damage
- Mounting hardware included: machine screws

DCG9	-26D
MODEL	FINISH

MODEL	USAGE
DCG7	Use with paired doors with an active door size (with astragal) $\leq 48"$ (1290 mm) wide OR paired doors with an inactive door (with astragal) $\leq 40"$ (1016 mm) wide OR paired doors both with astragals $\leq 34"$ (864 mm) wide
DCG9	Use with paired doors with active door size (with astragal) $> 48"$ (1290 mm) wide OR paired doors with inactive door with astragal $> 40"$ (1016 mm) wide OR paired doors both with astragals $> 34"$ (864 mm) wide



DOOR COORDINATORS

DOOR MULLION

REMOVABLE DOOR MULLION

M418NF, M424FR



TOP
BRACKET



M418NF



BOTTOM
BRACKET



- Removable steel door mullion for use on standard or fire rated pairs of doors
- Provides a solid and secure center point for latching double doors
- Requires wide stile doors with a minimum width of 3¼" (82.5 mm)
- 2 x 3" (50.8 x 76 mm) steel tube, ⅛" (3mm) gauge for heavy duty use
- Can accommodate door frames up to 96" (2438 mm) high
- Lockable or removable
- Accepts standard rim cylinder and includes cylinder mounting hardware, rim cylinder not included, see rim cylinder on page 05.410
- Cast steel top and bottom brackets included
- Painted aluminum finish
- Mounting hardware included: machine screws and floor anchors
- #M418NF for standard paired doors up to 96" (2438 mm) high
- #M424FR UL Listed for fire rated paired doors up to 96" (2438 mm) high and includes longer floor anchors
- #M418BK Top and bottom brackets for M418NF
- #M424BK Top and bottom brackets for M424FR

M418NF
MODEL

ELECTROMAGNETIC DOOR HOLDERS

WALL MOUNT

ABH ELECTROMAGNETIC DOOR HOLDER – WALL MOUNT, LOW PROFILE

ABH-2400



- cULus listed for smoke barrier or labelled fire doors
- 1 $\frac{7}{8}$ " (48 mm) total projection from wall to face of door;
2 $\frac{7}{8}$ " (73 mm) if using included 1" (25.4 mm) armature extension
- Tri-voltage units for easy stocking and installation (12V DC, 24V AC/DC, or 120V AC)
- Includes 1" (25.4 mm) armature extension
- 35 lb. (16 kg) holding force
- All metal components – No plastic parts
- Outlet box required (not provided)
- Armature features a pivot point which each has 360° mobility to help door alignment and reduce installation time
- Positive release button alleviates residual magnetism
- Satin aluminum finish – other finishes available
- Various armature extension rod lengths available

Available in a variety of finishes, models, and options. Please contact us to order.
Visit www.abhmfg.com for product or warranty details (coverage may vary by region).

ABH-2400	-28
MODEL	FINISH

PLEASE CONTACT FOR SELECTION HELP

ABH ELECTROMAGNETIC DOOR HOLDER – SURFACE WALL MOUNT

ABH-2510



- cULus listed for smoke barrier or labelled fire doors
- 4 $\frac{1}{2}$ " (114 mm) total projection from wall to face of door;
5 $\frac{1}{2}$ " (127 mm) if using included 1" (25.4 mm) armature extension
- 24V AC/DC magnetic coil
- Includes 1" (25.4 mm) armature extension
- 300 lb. (136 kg) holding force
- All metal components – No plastic parts
- Outlet box required (not included)
- Armature features pivot points with 360° mobility to help door alignment and reduce installation time
- Positive release button alleviates residual magnetism
- Satin aluminum finish – other finishes available
- Various armature extension rod lengths available

Available in a variety of finishes, models, and options. Please contact us to order.
Visit www.abhmfg.com for product or warranty details (coverage may vary by region).

ABH-2510	-28
MODEL	FINISH

PLEASE CONTACT FOR SELECTION HELP

ELECTROMAGNETIC DOOR HOLDERS

FLOOR MOUNT

ABH ELECTROMAGNETIC DOOR HOLDER – FLOOR MOUNT, SINGLE

ABH-2600



- cULus listed for smoke barrier or labelled fire doors
- Tri-voltage units for easy stocking and installation (12V DC, 24V AC/DC, or 120V AC)
- Includes 1" (25.4 mm) armature extension
- 35 lb. (16 kg) holding force
- All metal components – No plastic parts
- Outlet box required (not included)
- Armature features pivot point with 360° mobility to help door alignment and reduce installation time
- Positive release button alleviates residual magnetism
- Satin aluminum finish – other finishes available
- Various armature extension rod lengths available

OFFICIAL DISTRIBUTOR Available in a variety of finishes and options. Please contact us to order. Visit www.abhmfg.com for product or warranty details (coverage may vary by region).

ABH-2600	-28
MODEL	FINISH

PLEASE CONTACT FOR SELECTION HELP

ABH ELECTROMAGNETIC DOOR HOLDER – FLOOR MOUNT, DOUBLE

ABH-2700



- cULus listed for smoke barrier or labelled fire doors
- Tri-voltage units for easy stocking and installation (12V DC, 24V AC/DC, or 120V AC)
- 24V AC/DC magnetic coil
- Includes 1" (25.4 mm) armature extension
- 35 lb. (16 kg) holding force
- All metal components – No plastic parts
- Outlet box required (not included)
- Armature features two pivot points with 360° mobility to help door alignment and reduce installation time
- Positive release button alleviates residual magnetism
- Satin aluminum finish – other finishes available
- Various armature extension rod lengths available

OFFICIAL DISTRIBUTOR Available in a variety of finishes and options. Please contact us to order. Visit www.abhmfg.com for product or warranty details (coverage may vary by region).

ABH-2700	-28
MODEL	FINISH

PLEASE CONTACT FOR SELECTION HELP

