



DOOR LOCKS TABLE OF CONTENTS

| | |
|-------------------------|-----|
| Door Handing Guide..... | ii |
| Finish Guide..... | ii |
| Abbreviation Guide..... | iii |
| Function Guides..... | iv |

COMMERCIAL LOCKSETS

| | |
|--|--------|
| DOREX F1 Series, Cylindrical, Lever, Grade 1 BHMA | 01.010 |
| DOREX GX1 Series, Cylindrical, Lever, Grade 1 BHMA | 01.012 |
| DOREX F Series, Cylindrical, Lever, Grade 2 BHMA | 01.020 |
| DOREX T2 Series, Cylindrical, Lever, Grade 2..... | 01.021 |
| DOREX RW Series, Cylindrical, Lever, Grade 2..... | 01.023 |
| DOREX CW Series, Cylindrical, Lever, Grade 2..... | 01.024 |
| DOREX EM Series, Cylindrical, Lever, Grade 2..... | 01.026 |
| DOREX GX1B Series, Cylindrical, Knob, Grade 1 BHMA | 01.030 |
| DOREX TL Series, Cylindrical, Knob, Grade 2..... | 01.032 |
| DOREX T2B Series, Cylindrical, Knob, Grade 2..... | 01.034 |
| DOREX IL Series, Interconnected Cylindrical, Lever, Grade 2..... | 01.040 |
| DOREX T2IL Series, Interconnected Tubular, Lever, Grade 2..... | 01.042 |
| DOREX GX1A Series, Deadbolt, Grade 1..... | 01.050 |
| DOREX FHA Series, Deadbolt, Grade 2..... | 01.052 |
| DOREX TLA Series, Deadbolt, Grade 2..... | 01.054 |
| DOREX DG1 Series, Gatelatch, Grade 1..... | 01.060 |
| DOREX DG2 Series, Gatelatch, Grade 2..... | 01.062 |

MORTISE LOCKSETS

| | |
|---|--------|
| DOREX DM Series, Mortise, Grade 1 BHMA | 01.070 |
| DOREX DMDBL Series, Mortise Deadbolt, Grade 1..... | 01.074 |

RESIDENTIAL LOCKSETS

| | |
|------------------------------------|--------|
| DOREX Tecnica Design, Grade 3..... | 01.210 |
| DOREX Signature, Grade 3..... | 01.230 |
| DOREX Metro..... | 01.240 |
| DOREX Builders..... | 01.260 |

MISCELLANEOUS LOCKSETS

| | |
|------------------------|--------|
| Pocket Door Locks..... | 01.300 |
|------------------------|--------|

COMBINATION LOCKSETS

| | |
|---|--------|
| DOREX F400T Series, Deadbolt, RFID, Electronic Touch Keypad, Grade 2..... | 01.400 |
| DOREX F425T Series, Lever, RFID, Electronic Touch Keypad, Grade 2..... | 01.402 |
| DOREX F500T Series, Smart Electronic Deadbolt, Grade 2..... | 01.405 |
| ER Series, Deadbolt, Electronic Keypad..... | 01.410 |
| DOREX F500 Combo Electronic Entry Handleset..... | 01.415 |
| DOREX T300 Combo Electronic Entry Handleset..... | 01.416 |
| DDL 1150 Series, Lever, Mechanical Keypad..... | 01.420 |
| DDL 2200 Series, Knob, Mechanical Keypad..... | 01.422 |

PATCH FITTING LOCKSETS

| | |
|---|--------|
| PF Series, Patch Fitting, Lever..... | 01.500 |
| PF Series, Patch Fitting, Deadbolt..... | 01.510 |
| DOREX PLH900 Series, Universal Patch Lock & Strike Housing..... | 01.520 |

DOREX



DOOR HANDING GUIDE

LEFT HAND (LH)

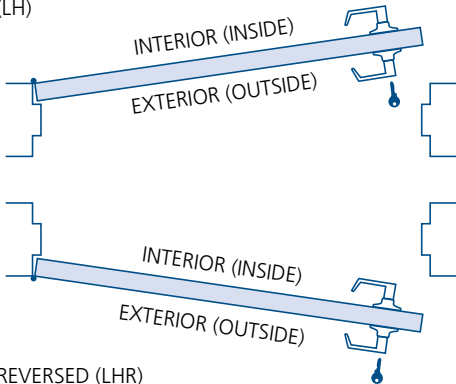

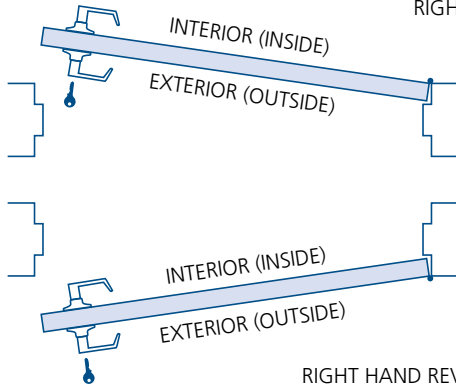

LEFT HAND REVERSED (LHR)

RIGHT HAND (RH)



RIGHT HAND REVERSED (RHR)

FINISH GUIDE

| | | | | |
|---|---|--|---|---|
|  |  |  |  |  |
| POLISHED BRASS | POLISHED BRASS (ENDURANCE) | SATIN BRASS | ANTIQUÉ BRASS | SATIN BRONZE |
| CODE BP, C3, 3 | V3 | C4, 4, SDB | AB, C5, 5 | C10, 10 |
| BHMA* 605, 632 | | 633 | 609, 638 | 639 |
|  |  |  |  |  |
| OIL RUBBED BRONZE⁽¹⁾ | ANTIQUÉ BRONZE | POLISHED NICKEL | SATIN NICKEL | ANTIQUÉ NICKEL |
| CODE C10B, 10B | C11P, 11 | C14, 14 | SDN, C15, 15 | C15A, 15A |
| BHMA* 640 | 617, 644 | 645 | 619, 646 | 620, 647 |
|  |  |  |  |  |
| MATTE BLACK | DARK BRONZE / DURANODIC | POLISHED CHROME | SATIN CHROME | POLISHED STAINLESS STEEL |
| CODE C19, 19 | BLR, DU, C20D, 20D | C26, 26 | C26D, 26D | C32, 32 |
| BHMA* 622, 631 | 649, 650, 690 | 625, 651 | 626, 652 | 629 |
|  | | | | |
| SATIN STAINLESS STEEL | | | | |
| CODE SS, C32D, 32D | | | | |
| BHMA* 630 | | | | |

ALL FINISHES IMAGES ABOVE ARE PHOTOGRAPHIC OR COLOUR APPROXIMATIONS, DELIVERED PRODUCT MAY VARY IN COMPARISON OR BETWEEN ORDERS/LOTS.

OTHER FINISHES AVAILABLE—PLEASE CONTACT.

(*) EQUIVALENT; CODES DIFFER DEPENDING ON BASE MATERIAL AND/OR FINISH PROCESS.

(1) OIL RUBBED BRONZE IS A «LIVING FINISH» WHOSE APPEARANCE WILL CHANGE OVER TIME.















DOOR LOCKS GENERAL INFORMATION

ABBREVIATION GUIDE

GENERAL











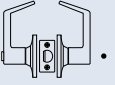

| | |
|------------|--|
| BS | Backset |
| DIA, Ø | Diameter |
| KG | Kilograms |
| LBS | Pounds |
| LH | Left hand |
| LHR | Left hand reversed |
| MAX | Maximum |
| MIN | Minimum |
| N/A, — | Not applicable / Not available |
| QTY | Quantity (usually followed by notes) |
| RH | Right hand |
| RHR | Right hand reversed |
| SQ, ▣ | Square |
| WT | Weight |
| /UNIT | Number of items per basic unit of sale (bagged or boxed) |
| /BOX, /BAG | Number of UNITS found in an inner carton or bag |
| /CASE | Number of BOXES or UNITS found in an outer (shipping) carton |

LEGEND

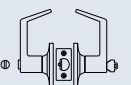

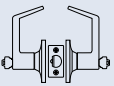
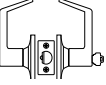
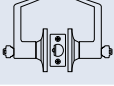
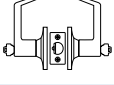
| | |
|---|---|
|    | FIRE RATED product. Sometimes includes duration of fire-resistance in minutes (M) or hours (H). |
|  | Small or Large Format Interchangeable Core (SFIC/LFIC) model or option available. |
|  | Keyed product or function. Keying services may be available. |
|  | Product, configuration or option meets ADA (Americans with Disabilities Act) requirements. |
|  | GRADE 1 product meets or exceeds standardized testing requirements for high traffic, commercial applications. |
|  | GRADE 2 product meets or exceeds standardized testing requirements for moderate traffic, commercial applications. |
|  | GRADE 3 product meets or exceeds standardized testing requirements for light traffic, commercial or residential applications. |
|  | Tested to Canadian and/or American safety and performance standards by Underwriters Laboratories® (UL). |
|  | Certified by the Builders Hardware Manufacturers Association® / American National Standards Institute®. |
|  | Product is equipped with or works with Radio-frequency Identification (RFID) readers or tags. |
|    | Limited warranty length in years, applicable to mechanical, electronic, or finish aspects of a product. |

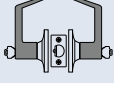

DOOR LOCKS GENERAL LOCKSET FUNCTION GUIDE

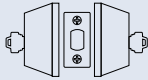
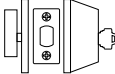

| FUNCTION | DESCRIPTION | ANSI | INSIDE / OUTSIDE |
|------------------------------|--|------|---|
| 10 PASSAGE | Latch bolt operated by lever from either side. | F75 |  |
| 15 EXIT | Deadlocking latch bolt operated by inside lever. Blank plate on outside. | — |  |
| 17 SINGLE DUMMY 00 | Lever and rose for one side of door to match other locksets. | — |  |
| 32 PATIO | Deadlocking latch bolt operated by lever from either side, except when inside push button locks outside lever. Push button released by turning inside lever or closing door to prevent lock-out. | F77 |  |
| 42 PRIVACY 40 | Latch bolt operated by lever from either side, except when inside push button locks outside lever. Push button released by turning inside lever or closing door to prevent lock-out. Outside lever has provision for emergency unlocking. | F76 |  |
| 51 ENTRY, OFFICE | Deadlocking latch bolt operated by lever from either side, except when inside push button locks outside lever. Push button released by turning inside lever. Outside lever is unlocked / locked by key. | — |  |
| 52 ENTRY | Deadlocking latch bolt operated by lever from either side, except when inside button is pushed and turned (with tool) to lock outside lever for entry by key only. Outside lever remains locked until push button is turned. | F109 |  |
| 53 ENTRY | Deadlocking latch bolt operated by lever from either side, except when inside button is pushed and turned to lock outside lever for entry by key only. Outside lever remains locked until push button is turned. | F109 |  |
| 60 STORE | Deadlocking latch bolt operated by lever from either side. A key used on either side locks or unlocks both sides. NOTE: for use in rooms with more than one exit. | F91 |  |
| 70 CLASSROOM | Deadlocking latch bolt operated by lever from either side, except when outside lever is locked by key. Inside lever is always free to allow exit. | F84 |  |
| 72 COMMUNICATING | Deadlocking latch bolt operated by lever on either side. Levers are always rigid when locked. Key in either lever locks or unlocks its own lever independently. NOTE: For use in rooms with more than one exit. | F80 |  |
| 75 CLASSROOM SECURITY | Deadlocking latch bolt operated by lever from either side. Key in either lever locks or unlocks outside lever. Inside lever is always free to allow exit. | F110 |  |
| 79 INSTITUTION EXIT | Deadlocking latch bolt operated by inside lever. Locked or unlocked by key from inside lever. Blank plate outside. | — |  |
| 80 STOREROOM | Deadlocking latch bolt operated by inside lever or key in outside lever. Outside lever always rigid. | F86 |  |
| 82 INSTITUTION or UTILITY | Deadlocking latch bolt operated by key in either side. Both levers always rigid. | F87 |  |
| 94 HOTEL or MOTEL | Deadlocking latch bolt operated by inside lever or key in outside lever. Inside push-button prevents use except by emergency key and projects visual occupancy indicator outside. Push-button released by closing door or turning inside knob. Outside lever always rigid. | F93 |  |

DOOR LOCKS GENERAL DEADBOLT FUNCTION GUIDE

| FUNCTION | DESCRIPTION | INSIDE / OUTSIDE |
|--|---|---|
| 42 PRIVACY | Deadbolt operated by outside emergency key (or tool) or inside thumb turn at all times. |  |
| 51 SINGLE CYLINDER | Deadbolt operated by outside key or inside thumb turn at all times. |  |
| 55 ONE SIDED or THUMBTURN ONLY | Deadbolt operated by inside thumb turn only at all times. |  |
| 57 ONE SIDED, EXTERIOR PLATE or THUMBTURN ONLY, EXTERIOR PLATE | Deadbolt operated by inside thumb turn only at all times. Blank plate on outside. |  |
| 60 DOUBLE CYLINDER | Deadbolt operated by key in either cylinder at all times. NOTE: for use in rooms with more than one exit. |  |
| 70 SINGLE CYLINDER, CLASSROOM | Deadbolt engaged by outside key only. Inside thumbturn is always free to allow exit. |  |

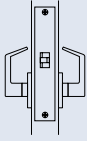
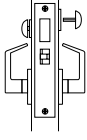
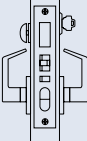
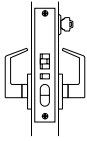
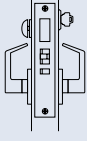
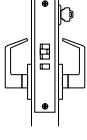
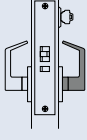
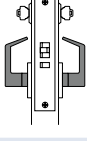
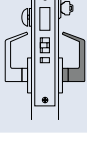

DOOR LOCKS MORTISE LOCKSET FUNCTION GUIDE

| FUNCTION | DESCRIPTION | INSIDE / OUTSIDE |
|----------------------------|---|---|
| 10 PASSAGE | Latch bolt operated by lever from either side at all times. |  |
| 42 PRIVACY | Latch bolt operated by lever from either side except when thumb turn projects dead bolt and locks outside lever. Unlock by turning inside lever or by using outside emergency key, which retracts the deadbolt. |  |
| 45 ENTRANCE | Latch bolt operated by lever from either side except when outside lever is locked by push button rocker. Deadbolt projected by outside key and by thumb turn from inside. Deadbolt retracted by outside key. Rotating inside lever retracts both bolts (simultaneous retraction). Auxiliary latch deadlocks latch bolt. |  |
| 50 OFFICE | Latch bolt operated by lever from either side except when outside lever is locked by push button rocker or outside key. Latch bolt may be retracted by outside key or inside lever. Auxiliary latch deadlocks latch bolt. |  |
| 56 DORMITORY | Latch bolt operated by lever from either side or outside key. Deadbolt projected/retracted by key from outside and thumb turn from inside. Rotating inside lever retracts both bolts simultaneously. Extended deadbolt automatically deadlocks latch bolt. |  |
| 70 CLASSROOM | Latch bolt activated by lever from either side, except when outside lever is locked by outside key. Inside lever is always free to allow exit. Auxiliary latch deadlocks latch bolt. |  |
| 80 STOREROOM | Latch bolt operated by outside key or by inside lever. Outside lever is always locked. Auxiliary latch deadlocks latch bolt. |  |
| 82 INSTITUTION or UTILITY | Latch bolt retracted by key from either side. Lever on both sides always inoperative. Auxiliary latch deadlocks latch bolt. |  |
| 84 STOREROOM WITH DEADBOLT | Deadbolt projected and retracted by outside key or by inside lever or thumb turn. Inside lever retracts both bolts simultaneously. Extended deadbolt automatically deadlocks latch bolt. |  |
| 171 SINGLE DUMMY | Fixed, through-bolt mounted, inside or outside, single lever. *Surface mount available. |  |
| 172 BACK-TO-BACK DUMMY | Fixed, through-bolt mounted, inside and outside, paired levers. |  |



F1H



- Type** • Cylindrical lock
- Certifications**
 - Certified ANSI/BHMA A156.2, Series 4000, Grade 1
 - cULus listed, 3hr fire-rating
 - UL 10C Positive Pressure Rating
 - Meets ADA requirements
 - 10 Year limited warranty
- Door Thickness** • 1³/₈–2¹/₄" (35–57 mm)
- Handing** • Non handed
- Backset**
 - 2³/₄" (70 mm)
 - 2³/₈" (60 mm) – available
- Spring Latch**
 - Stainless steel, 1/2" (12.7 mm) throw
 - Deadlatch, 3/4" (19 mm) throw – available
- Faceplate**
 - Mortise type, square corners
 - 1¹/₈x2¹/₄" (28.5x57 mm)
- Strike** • ASA Strike
- Trim**
 - Solid, pressure cast heavy duty lever
 - Lever secured by additional set screw
 - Brass rose
 - Rose diameter: 3¹/₂" (89 mm)

- Chassis**
 - Concealed mounting plate and screws
 - Fixed security posts
 - Lever clutch release

- Preparation**
 - Cross bore: 2¹/₈" (54 mm)
 - Edge bore: 1" (25.4 mm)

- Cylinder**
 - Solid brass, 6-pin
 - Schlage "C" keyway, 2 keys
 - Removable, rekeyable
 - Small format interchangeable core (SFIC) model – available*

Other keyways and keying options available, including CX5 high security. () BEST® and CX5® cores sold separately.*

- | | | |
|------------------|------------------|--------------|
| Functions | 10 Passage | 53 Entry |
| | 17 Dummy, single | 70 Classroom |
| | 42 Privacy | 80 Storeroom |

- Lever Styles** C–Curved return*, H–Standard return, S–Straight; no return*

() Special order.*

- Finish** 26D–Satin chrome

Other finishes available by special order.

| | | | | |
|--------|-------|----------|--------|---------------------|
| F1 | H | 53 | 26D | 238 |
| SERIES | STYLE | FUNCTION | FINISH | OPTION ¹ |

(1) OPTION: 238 2-3/8IN (60MM) BACKSET

SELECTION GUIDE

| SERIES | STYLE | FUNCTION ² | FINISH ² | / CASE |
|--------|------------------------------------|-----------------------|---------------------|--------|
| F1 | C ¹ , H, S ¹ | 10 Passage | 26D | 6 |
| F1 | C ¹ , H, S ¹ | 17 Dummy, single | 26D | 12 |
| F1 | C ¹ , H, S ¹ | 42 Privacy | 26D | 6 |
| F1 | C ¹ , H, S ¹ | 53 Entry ↔ | 26D | 6 |
| F1 | C ¹ , H, S ¹ | 70 Classroom ↔ | 26D | 6 |
| F1 | C ¹ , H, S ¹ | 80 Storeroom ↔ | 26D | 6 |

(1) SPECIAL ORDER. (2) OTHER FINISHES AND FUNCTIONS AVAILABLE BY SPECIAL ORDER. MAY REQUIRE MINIMUM ORDER QUANTITIES AND/OR ADDITIONAL DELIVERY TIMES.

↔ KEYED FUNCTION; FULL KEYING SERVICES AVAILABLE.

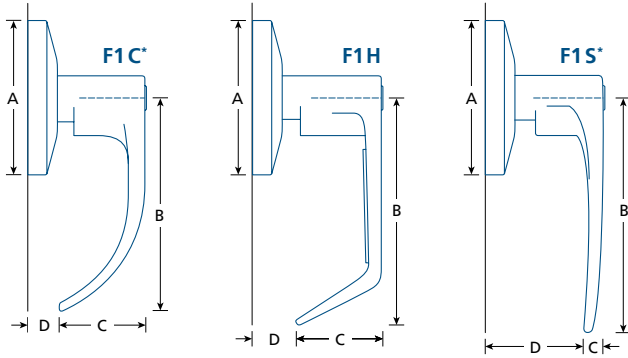

(*) SPECIAL ORDER.

| | | A | B | C | D* |
|-----|---|------------|-------------|--------------|-------------|
| F1C | ♿ | 3½ (89) | 4½ (114) | 2½ (63.3) | ⅝ (16) |
| F1H | ♿ | 3½ (89) | 5 (127) | 2½ (63.3) | ½ (12.7) |
| F1S | ♿ | 3½ (89) | 5 (127) | ¾ (19) | 2⅜ (56) |

IN (MM) (*) DIMENSION MAY VARY DUE TO DOOR THICKNESS.

PARTS & ACCESSORIES



9106

T-Strike, square corners:
1½x2¾" (28.5x70 mm)

9106NH

T-Strike, no hole; square corners:
1½x2¾" (28.5x70 mm)



ASA-T

ASA strike with adjustable tab

ASANH

ASA strike, no hole



F1001

Passage latch: 2¾" (60 mm) backset,
1½x2¼" (28.5x57 mm) faceplate



F1010

Privacy latch: 2¾" (60 mm) backset,
1½x2¼" (28.5x57 mm) faceplate



F1DL234-34

Deadlatch: 2¾" (70 mm) backset, ¾" (19 mm)
throw. 1½x2¼" (28.5x57 mm) faceplate
For use in double door or electric strike applications





- Type** • Cylindrical lock
- Certifications**
- Certified ANSI/BHMA A156.2, Series 4000, Grade 1
 - cULus listed, 3hr fire-rating
 - UL 10C Positive Pressure Rating
 - Meets ADA requirements
 - 10 Year limited warranty
- Door Thickness**
- 1 $\frac{3}{8}$ –2" (35–51mm)
 - SFIC Models: 1 $\frac{9}{16}$ –2" (40–51mm)
- Handing** • Non handed
- Backset**
- 2 $\frac{3}{4}$ " (70 mm)
 - 2 $\frac{3}{8}$ " (60 mm) – available
 - 3 $\frac{3}{4}$ " (95 mm) – available
 - 5" (127 mm) – available
- Spring Latch**
- Stainless steel, $\frac{1}{2}$ " (12.7 mm) throw
 - Deadlatch, $\frac{3}{4}$ " (19 mm) throw – available
- Faceplate**
- Mortise type, square corners
 - 1 $\frac{1}{8}$ x2 $\frac{1}{4}$ " (28.5x57 mm)
- Strike** • ASA Strike
- Trim**
- Solid, pressure cast lever
 - Brass rose
 - Rose diameter: 3 $\frac{9}{16}$ " (90 mm)

- Chassis**
- Concealed mounting plate and screws
 - Fixed security posts
 - Lever clutch release
- Preparation**
- Cross bore: 2 $\frac{1}{8}$ " (54 mm)
 - Edge bore: 1" (25.4 mm)
- Cylinder**
- Solid brass, 6-pin
 - Schlage "C" keyway, 2 keys
 - Removable, rekeyable
 - Small format interchangeable core (SFIC) model – available*
- Other keyways and keying options available, including CX5 high security. (*) BEST® and CX5® cores sold separately.*
- Functions**
- | | | | |
|----|---------------|----|--------------------|
| 10 | Passage | 60 | Store |
| 15 | Exit | 70 | Classroom |
| 17 | Dummy, single | 75 | Classroom security |
| 42 | Privacy | 80 | Storeroom |
| 53 | Entry | 82 | Institution |
- Lever Styles** C–Curved return, L–Standard return, S–Straight; no return
- Finish** C19–Matte black, C26D–Satin chrome
- Other finishes available by special order*



| | | | |
|--------|-------|----------|--------|
| GX1 | L | 53 | C26D |
| SERIES | STYLE | FUNCTION | FINISH |

SELECTION GUIDE

| SERIES | STYLE | FUNCTION ¹ | FINISH ¹ | /CASE |
|--------|---------|---------------------------------|------------------------|-------|
| GX1 | C, L, S | 10 Passage | C26D, C19 ² | 6 |
| GX1 | L | 15 Exit | C26D | 6 |
| GX1 | L | 17 Dummy, single | C26D, C19 ² | 6 |
| GX1 | C, L, S | 42 Privacy | C26D, C19 ² | 6 |
| GX1 | C, L, S | 53 Entry ↔ | C26D, C19 ² | 6 |
| GX1 | C, L, S | 53IC Entry SFIC* ↔ | C26D, C19 ² | 6 |
| GX1 | L | 60IC Store SFIC* ↔ | C26D | 6 |
| GX1 | C, L, S | 70 Classroom ↔ | C26D, C19 ² | 6 |
| GX1 | C, L, S | 70IC Classroom SFIC* ↔ | C26D, C19 ² | 6 |
| GX1 | L | 75 Classroom security ↔ | C26D | 6 |
| GX1 | L | 75IC Classroom security SFIC* ↔ | C26D | 6 |
| GX1 | C, L, S | 80 Storeroom ↔ | C26D, C19 ² | 6 |
| GX1 | C, L, S | 80IC Storeroom SFIC* ↔ | C26D, C19 ² | 6 |
| GX1 | L | 82 Institution ↔ | C26D | 6 |

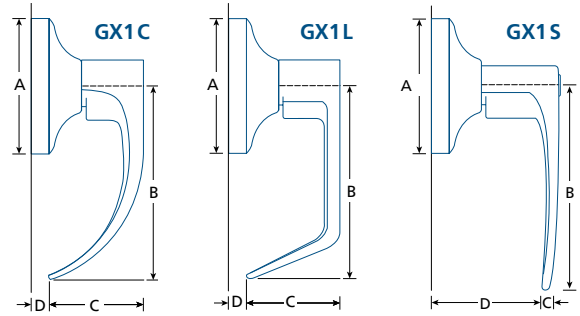
(1) OTHER FINISHES AND FUNCTIONS AVAILABLE, MINIMUM ORDER QUANTITIES AND/OR ADDITIONAL DELIVERY TIMES MAY BE REQUIRED. (2) GX1L ONLY (*) ALL SFIC MODELS ARE LESS CORE
 ↔ KEYED FUNCTION; FULL KEYING SERVICES AVAILABLE.



| | A | B | C | D* |
|---|--|------------|---|--|
| GX1C  | 3 ⁹ / ₁₆ (90) | 5 (127) | 2 ¹ / ₂ (63.3) | 3 ³ / ₈ (10) |
| GX1L  | 3 ⁹ / ₁₆ (90) | 5 (127) | 2 ⁵ / ₈ (66.7) | 3 ³ / ₈ (10) |
| GX1S  | 3 ⁹ / ₁₆ (90) | 5 (127) | 7 ⁷ / ₈ (22) | 2 ⁷ / ₁₆ (62) |

IN (MM) (*) DIMENSION MAY VARY DUE TO DOOR THICKNESS.

PARTS & ACCESSORIES



9106
T-Strike, square corners:
1¹/₈x2³/₄" (28.5x70 mm)

9106NH
T-Strike, no hole; square corners:
1¹/₈x2³/₄" (28.5x70 mm)



ASA-T
ASA strike with adjustable tab

ASANH
ASA strike, no hole



CX5-9807
CX5 high security SFIC core, 7 pin, 0 bitting

CBI-BF6KD-26D
BEST® F type SFIC core, 6 pin, keyed different

CBI-BF7KD-26D
BEST® F type SFIC core, 7 pin, keyed different



GX1SL238
Passage latch: 2³/₈" (60 mm) backset,
1¹/₈x2¹/₄" (28.5x57 mm) faceplate

GX1SL234
Passage latch: 2³/₄" (70 mm) backset,
1¹/₈x2¹/₄" (28.5x57 mm) faceplate

GX1PL238
Privacy latch: 2³/₈" (60 mm) backset,
1¹/₈x2¹/₄" (28.5x57 mm) faceplate

GX1PL234
Privacy latch: 2³/₄" (70 mm) backset,
1¹/₈x2¹/₄" (28.5x57 mm) faceplate



GX1DL238
Deadlatch: 2³/₈" (60) backset,
1¹/₈x2¹/₄" (28.5x57 mm) faceplate

GX1DL234
Deadlatch: 2³/₄" (70 mm) backset,
1¹/₈x2¹/₄" (28.5x57 mm) faceplate



GX1DL234-34
Deadlatch: 2³/₄" (70 mm) backset, 3⁴/₈" (19 mm) throw,
1¹/₈x2¹/₄" (28.5x57 mm) faceplate
For use in double door or electric strike applications



GX1LE334
Backset extension to 3³/₄" (95 mm); use with
2³/₈" (60 mm) backset latch

GX1LE500
Backset extension to 5" (127 mm); use with
2³/₄" (70 mm) backset latch





- Type** • Cylindrical lock, electrified
- Certifications**
 - Certified ANSI/BHMA A156.2, Series 4000, Grade 1
 - cULus listed, 3hr fire-rating
 - UL 10C Positive Pressure Rating
 - Meets ADA requirements
 - 10 Year limited mechanical warranty
 - 1 Year limited electronic warranty
- Door Thickness**
 - 1 $\frac{1}{8}$ –2" (35–51mm)
 - SFIC Models: 1 $\frac{9}{16}$ –2" (40–51mm)
- Handing** • Non handed
- Backset**
 - 2 $\frac{3}{4}$ " (70mm)
 - 2 $\frac{3}{8}$ " (60mm) – available
 - 3 $\frac{3}{4}$ " (95mm) – available
 - 5" (127mm) – available
- Spring Latch**
 - Stainless steel, 1/2" (12.7mm) throw
 - Deadlatch, 3/4" (19mm) throw – available
- Faceplate**
 - Mortise type, square corners
 - 1 $\frac{1}{8}$ x2 $\frac{1}{4}$ " (28.5x57mm)
- Strike** • ASA Strike
- Trim**
 - Solid, pressure cast lever
 - Brass rose
 - Rose diameter: 3 $\frac{3}{16}$ " (90mm)

- Chassis**
 - Concealed mounting plate and screws
 - Fixed security posts
 - Lever clutch release
- Preparation**
 - Cross bore: 2 $\frac{1}{8}$ " (54mm)
 - Edge bore: 1" (25.4mm)
- Cylinder**
 - Solid brass, 6-pin
 - Schlage "C" keyway, 2 keys
 - Removable, rekeyable
 - Small format interchangeable core (SFIC) model – available*

Other keyways and keying options available, including CX5 high security. () BEST® and CX5® cores sold separately.*
- Electrical Options**
 - EL Fail Safe (Power fails = Unlocked)
 - EL-RX Fail Safe, Request to Exit
 - EU Fail Secure (Power fails = Locked)
 - EU-RX Fail Secure, Request to Exit
- Power** • Dual-voltage 12–24VDC
- Current** • 12VDC – 0.6A @ 20Ω
- Draw** • 24VDC – 0.3A @ 80Ω
- Operation Temperature** • -32° to 120°F (-0° to 49°C)
Temperature tolerance can vary due to weather.
- Function** 80 Storeroom
- Lever Styles** C–Curved return, L–Standard return, S–Straight; no return
- Finish** C19–Matte black; C26D–Satin chrome
Other finishes available by special order

| | | | | | | | |
|--------|-------|----------|--------|---|---------------------|---|---------------------|
| GX1 | L | 80 | C26D | – | EL | – | RX |
| SERIES | STYLE | FUNCTION | FINISH | | OPTION ¹ | | OPTION ² |

(1) EL: FAIL SAFE (2) RX: WITH REQUEST TO EXIT

SELECTION GUIDE

| SERIES | STYLE | FUNCTION ¹ | FINISH ¹ | /CASE |
|--------|---------|-----------------------|---------------------|-------|
| GX1 | C, L, S | 80 Storeroom | C19, C26D | 6 |

(1) SFIC AND OTHER FUNCTIONS AND FINISHES AVAILABLE, MINIMUM ORDER QUANTITIES AND/OR ADDITIONAL DELIVERY TIMES MAY BE REQUIRED.
 KEYED FUNCTION; FULL KEYING SERVICES AVAILABLE.

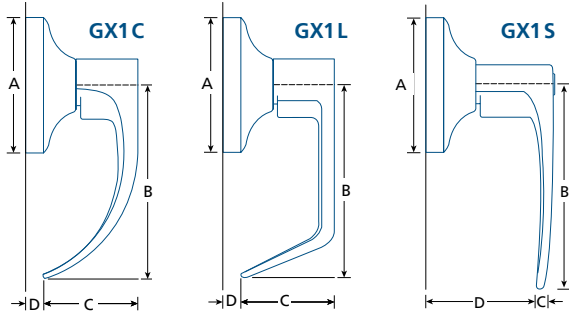

| | A | B | C | D* |
|-------------|--|------------|---|--|
| GX1C | 3 ⁹ / ₁₆ (90) | 5 (127) | 2 ¹ / ₂ (63.3) | 3 ³ / ₈ (10) |
| GX1L | 3 ⁹ / ₁₆ (90) | 5 (127) | 2 ⁵ / ₈ (66.7) | 3 ³ / ₈ (10) |
| GX1S | 3 ⁹ / ₁₆ (90) | 5 (127) | 7 ⁷ / ₈ (22) | 2 ⁷ / ₁₆ (62) |

IN (MM) (*) DIMENSION MAY VARY DUE TO DOOR THICKNESS.

PARTS & ACCESSORIES



9106
T-Strike, square corners:
1¹/₈x2³/₄" (28.5x70 mm)

9106NH
T-Strike, no hole; square corners:
1¹/₈x2³/₄" (28.5x70 mm)



ASA-T
ASA strike with adjustable tab

ASANH
ASA strike, no hole



CX5-9807
CX5 high security SFIC core, 7 pin, 0 bitted

CBI-BF6KD-26D
BEST@ F type SFIC core, 6 pin, keyed different

CBI-BF7KD-26D
BEST@ F type SFIC core, 7 pin, keyed different



JC-603QC-BB1079-ETW04/08
Wired power transfer hinge with 4 or 8, 28 AWG wires (MAX. 24V, 4A) with molex connector. Must be installed with ball bearing hinges of the same size (4¹/₂x4). Not rated for use on fire doors. See page 04.620 for more details.



GX1SL238
Passage latch: 2³/₈" (60 mm) backset,
1¹/₈x2¹/₄" (28.5x57 mm) faceplate



GX1SL234
Passage latch: 2³/₄" (70 mm) backset,
1¹/₈x2¹/₄" (28.5x57 mm) faceplate



GX1PL238
Privacy latch: 2³/₈" (60 mm) backset,
1¹/₈x2¹/₄" (28.5x57 mm) faceplate



GX1PL234
Privacy latch: 2³/₄" (70 mm) backset,
1¹/₈x2¹/₄" (28.5x57 mm) faceplate



GX1DL238
Deadlatch: 2³/₈" (60) backset,
1¹/₈x2¹/₄" (28.5x57 mm) faceplate



GX1DL234
Deadlatch: 2³/₄" (70 mm) backset,
1¹/₈x2¹/₄" (28.5x57 mm) faceplate



GX1DL234-34
Deadlatch: 2³/₄" (70 mm) backset, 3⁴/₄" (19 mm) throw, 1¹/₈x2¹/₄" (28.5x57 mm) faceplate
For use in double door or electric strike applications



GX1LE334
Backset extension to 3³/₄" (95 mm); use with 2³/₈" (60 mm) backset latch



GX1LE500
Backset extension to 5" (127 mm); use with 2³/₄" (70 mm) backset latch





- Type** • Cylindrical lock
- Certifications**
 - Certified ANSI/BHMA A156.2, Series 4000, Grade 2
 - cULus listed, 3hr fire-rating
 - UL 10C Positive Pressure Rating
 - Meets ADA requirements
 - 10 Year limited warranty
- Door Thickness** • 1³/₈ – 1³/₄" (35 – 44.5 mm)
- Handing** • Non handed
- Backset**
 - 2³/₄" (70 mm)
 - 2³/₈" (60 mm) – available
 - 3³/₄" (95 mm) – available
 - 5" (127 mm) – available
- Spring Latch** • Stainless steel, 1/2" (12.7 mm) throw
- Faceplate**
 - Mortise type, square corners
 - 1¹/₈ x 2¹/₄" (28.5 x 57 mm)
- Strike** • ASA Strike
- Trim**
 - Solid, pressure cast lever
 - Brass rose
 - Rose diameter: 3⁵/₁₆" (84.5 mm)

- Chassis**
 - Concealed mounting plate and screws
 - Removable security posts
 - Lever clutch release – option*
- (* For keyed functions, may require special order)

- Preparation**
 - Cross bore: 2¹/₈" (54 mm)
 - Edge bore: 1" (25.4 mm)

- Cylinder**
 - Solid brass, 6-pin
 - Schlage "C" keyway, 2 keys
 - Removable, rekeyable

Other keyways and keying options available, including CX5 high security

| | | |
|------------------|------------------|----------------|
| Functions | 10 Passage | 53 Entry* |
| | 15 Exit | 60 Store |
| | 17 Dummy, single | 70 Classroom |
| | 42 Privacy | 80 Storeroom* |
| | 51 Office | 82 Institution |

(* Lever clutch release available (-0))

- Lever Styles** C–Curved return, H–Standard return, L–Linear; no return, S–Straight; no return

- Finish** C19–Matte black, C26D–Satin chrome, C3–Polished brass

Other finishes available by special order

| | | | | | |
|--------|-------|----------|--------|---|---------------------|
| F | H | 53 | C26D | – | O |
| SERIES | STYLE | FUNCTION | FINISH | | OPTION ¹ |

(1) OPTIONS: 238 2-3/8IN (60MM) BACKSET O LEVER CLUTCH RELEASE (53 & 80 ONLY)





SELECTION GUIDE

| SERIES | STYLE | FUNCTION ¹ | FINISH ¹ | / CASE |
|--------|------------|---------------------------------------|----------------------------|--------|
| F | C, H, L, S | 10 Passage | C26D, C3, C19 ² | 12 |
| F | C, H, S | 15 Exit | C26D | 12 |
| F | C, H, L, S | 17 Dummy, single | C26D, C3, C19 ² | 40 |
| F | C, H, L, S | 42 Privacy | C26D, C3, C19 ² | 12 |
| F | C, H, S | 51 Office ↔ | C26D | 12 |
| F | C, H, L, S | 53 Entry ↔ | C26D, C3, C19 ² | 12 |
| F | C, H | 53-O Entry, with clutch release ↔ | C26D | 12 |
| F | C, H, S | 60 Store ↔ | C26D | 12 |
| F | C, H, L, S | 70 Classroom ↔ | C26D, C3, C19 ² | 12 |
| F | C, H, L, S | 80 Storeroom ↔ | C26D, C3, C19 ² | 12 |
| F | C, H | 80-O Storeroom, with clutch release ↔ | C26D | 12 |
| F | C, H, S | 82 Institution / utility ↔ | C26D | 12 |

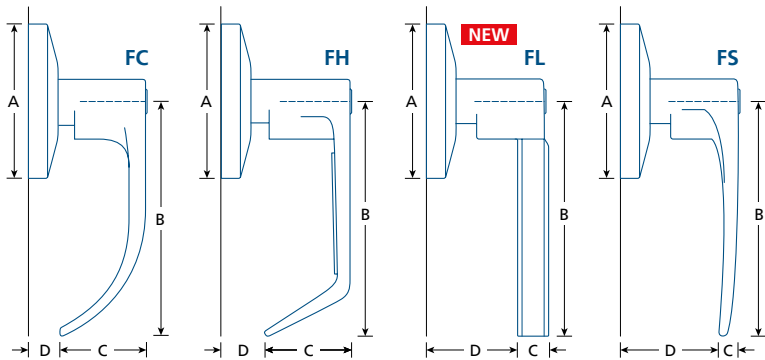
(1) OTHER FINISHES AND FUNCTIONS AVAILABLE, MINIMUM ORDER QUANTITIES AND/OR ADDITIONAL DELIVERY TIMES MAY BE REQUIRED.

↔ KEYED FUNCTION; FULL KEYING SERVICES AVAILABLE. (1) NOTE: IN-STOCK FS LEVERS ARE ONLY AVAILABLE IN C26D. (2) FH, FL ONLY.



| | A | B | C | D* |
|---|------------------|------------------|---------------|-------------------|
| FC  | 3 5/16 (84.5) | 4 1/2 (114) | 1 7/8 (48) | 1/4 (6.4) |
| FH  | 3 5/16 (84.5) | 4 1/2 (114) | 1 7/8 (48) | 7/16 (10.9) |
| FL  | 3 5/16 (84.5) | 4 11/16 (119) | 3/4 (19) | 1 27/32 (46.8) |
| FS  | 3 5/16 (84.5) | 4 11/16 (119) | 9/16 (14) | 1 27/32 (46.8) |

IN (MM) (*) DIMENSION MAY VARY DUE TO DOOR THICKNESS.

PARTS & ACCESSORIES



9106

T-Strike, square corners:
1 1/8 x 2 3/4" (28.5 x 70 mm)

9106NH

T-Strike, no hole; square corners:
1 1/8 x 2 3/4" (28.5 x 70 mm)



ASA-T

ASA strike with adjustable tab

ASANH

ASA strike, no hole



TL013

Backset extension to 3 3/4" (95 mm);
Use with 2 3/8" (60 mm) backset latch

TL014

Backset extension to 5" (127 mm);
Use with 2 3/4" (70 mm) backset latch



FH001

Passage latch: 2 3/8" (60 mm) backset,
1 1/8 x 2 1/4" (28.5 x 57 mm) faceplate

FH003

Passage latch: 2 3/4" (70 mm) backset,
1 1/8 x 2 1/4" (28.5 x 57 mm) faceplate

FH010

Privacy latch: 2 3/8" (60 mm) backset,
1 1/8 x 2 1/4" (28.5 x 57 mm) faceplate

FH002

Privacy latch: 2 3/4" (70 mm) backset,
1 1/8 x 2 1/4" (28.5 x 57 mm) faceplate



FH005

Deadlatch: 2 3/8" (60 mm) backset,
1 1/8 x 2 1/4" (28.5 x 57 mm) faceplate

FH004

Deadlatch: 2 3/4" (70 mm) backset,
1 1/8 x 2 1/4" (28.5 x 57 mm) faceplate





- Type** • Cylindrical lock
- Certifications**
 - Conforms to ANSI/BHMA A156.2, Series 4000, Grade 2
 - cULus listed, 3hr fire-rating
 - UL 10C Positive Pressure Rating
 - Meets ADA requirements
 - 10 Year limited warranty
- Door Thickness** • 1 $\frac{3}{8}$ –2" (35–51 mm)
- Handing** • Non handed
- Backset**
 - 2 $\frac{3}{4}$ " (70 mm)
 - 2 $\frac{3}{8}$ " (60 mm) – available
 - 3 $\frac{3}{4}$ " (95 mm) – available
 - 5" (127 mm) – available
- Spring Latch**
 - Stainless steel, $\frac{1}{2}$ " (12.7 mm) throw
 - Deadlatch, $\frac{3}{4}$ " (19 mm) throw – available
- Faceplate**
 - Mortise type, square corners
 - 1 $\frac{1}{8}$ x2 $\frac{1}{4}$ " (28.5x57 mm)
- Strike** • ASA Strike
- Trim**
 - Solid, pressure cast lever
 - Brass rose
 - Rose diameter: 3 $\frac{5}{16}$ " (84.5 mm)

- Chassis**
 - Concealed mounting plate and screws
 - Removable security posts
 - Lever clutch release – option*

(*) For keyed functions, may require special order

- Preparation**
 - Cross bore: 2 $\frac{1}{8}$ " (54 mm)
 - Edge bore: 1" (25.4 mm)

- Cylinder**
 - Solid brass, 6-pin
 - Schlage "C" keyway, 2 keys
 - Removable, rekeyable

Other keyways and keying options available, including CX5 high security

- | | | |
|------------------|------------------|--------------|
| Functions | 00 Dummy, single | 53 Entry |
| | 10 Passage | 70 Classroom |
| | 40 Privacy | 80 Storeroom |

- Lever Styles** F–The Flat; H–Standard return

- Finish** 15–Satin nickel, 19–Matte black, 26D–Satin chrome

Other finishes available by special order

| | | | | | | |
|--------|-------|----------|---|--------|---|---------------------|
| T2 | F | 53 | – | 26D | – | C |
| SERIES | STYLE | FUNCTION | | FINISH | | OPTION ¹ |

(1) C: CLUTCH RELEASE.

SELECTION GUIDE

| SERIES | STYLE | FUNCTION ¹ | FINISH ¹ | / CASE |
|--------|-------|---------------------------------------|---|--------|
| T2 | F, H | 00 Dummy, single | 15 ² , 19 ² , 26D | 12 |
| T2 | F, H | 10 Passage | 15 ² , 19 ² , 26D | 6 |
| T2 | F, H | 40 Privacy, push button thumb-turn | 15 ² , 19 ² , 26D | 6 |
| T2 | F, H | 53 Entry ↔ | 15 ² , 19 ² , 26D | 6 |
| T2 | H | 53-C Entry, with clutch release ↔ | 26D | 6 |
| T2 | F, H | 70 Classroom ↔ | 15 ² , 19 ² , 26D | 6 |
| T2 | H | 70-C Classroom, with clutch release ↔ | 26D | 6 |
| T2 | F, H | 80 Storeroom ↔ | 15 ² , 19 ² , 26D | 6 |
| T2 | H | 80-C Storeroom, with clutch release ↔ | 26D | 6 |

(1) OTHER FINISHES AND FUNCTIONS AVAILABLE, MINIMUM ORDER QUANTITIES AND/OR ADDITIONAL DELIVERY TIMES MAY BE REQUIRED. (2) AVAILABLE FOR T2H BY SPECIAL ORDER.

↔ KEYED FUNCTION; FULL KEYING SERVICES AVAILABLE.

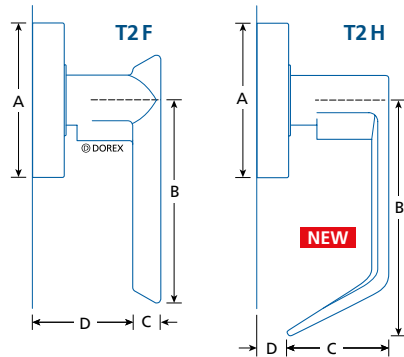

| | | A | B | C | D* |
|-----|---|--|---|--|--------------------------------------|
| T2F | Ⓛ | 3 ⁵ / ₁₆ (84.5) | 4 ⁷ / ₃₂ (107) | ⁵ / ₈ (16.7) | 2 (51.3) |
| T2H | Ⓛ | 3 ⁵ / ₁₆ (84.5) | 4 ¹ / ₂ (114) | 2 ⁵ / ₁₆ (58.7) | ³ / ₈ (9.5) |

IN (MM)

(* DIMENSION MAY VARY DUE TO DOOR THICKNESS.

PARTS & ACCESSORIES



9106

T-Strike, square corners:
1 ¹/₈ x 2 ³/₄ " (28.5 x 70 mm)

9106NH

T-Strike, no hole; square corners:
1 ¹/₈ x 2 ³/₄ " (28.5 x 70 mm)



ASA-T

ASA strike with adjustable tab

ASANH

ASA strike, no hole



TL020

Plastic spacer for latches with 1 x 2 ¹/₄ " (25.4 x 57 mm) faceplate to fit preparations for 1 ¹/₈ x 2 ¹/₄ " (28.5 x 57 mm) faceplates



TL013

Backset extension to 3 ³/₄ " (95 mm);
Use with 2 ³/₈ " (60 mm) backset latch

TL014

Backset extension to 5 " (127 mm);
Use with 2 ³/₄ " (70 mm) backset latch



TL001

Passage latch: 2 ³/₈ " (60 mm) backset,
1 x 2 ¹/₄ " (25.4 x 57 mm) faceplate

TL003

Passage latch: 2 ³/₄ " (70 mm) backset,
1 ¹/₈ x 2 ¹/₄ " (28.5 x 57 mm) faceplate

TL010

Privacy latch: 2 ³/₈ " (60 mm) backset,
1 x 2 ¹/₄ " (25.4 x 57 mm) faceplate

TL002

Privacy latch: 2 ³/₄ " (70 mm) backset,
1 ¹/₈ x 2 ¹/₄ " (28.5 x 57 mm) faceplate



TL005

Deadlatch: 2 ³/₈ " (60 mm) backset,
1 x 2 ¹/₄ " (25.4 x 57 mm) faceplate

TL004

Deadlatch: 2 ³/₄ " (70 mm) backset,
1 ¹/₈ x 2 ¹/₄ " (28.5 x 57 mm) faceplate

TL006

Deadlatch: 5 " (127 mm) backset,
1 ¹/₈ x 2 ¹/₄ " (28.5 x 57 mm) faceplate



GX1DL234-34

Deadlatch: 2 ³/₄ " (70 mm) backset, ³/₄ " (19 mm) throw, 1 ¹/₈ x 2 ¹/₄ " (28.5 x 57 mm) faceplate
For use in double door or electric strike applications





- Type** • Cylindrical lock
- Certifications**
 - Conforms to ANSHI/BHMA A156.2, Series 4000, Grade 2
 - cULus listed, 3hr fire-rating
 - UL 10C Positive Pressure Rating
 - Meets ADA requirements
 - 1 Year limited warranty
- Door Thickness**
 - 1 $\frac{3}{8}$ – 1 $\frac{3}{4}$ " (35–45 mm)
 - Indicator model: 1 $\frac{3}{4}$ " (45 mm)
- Handing** • Non handed
- Backset**
 - 2 $\frac{3}{4}$ " (70 mm)
 - 2 $\frac{3}{8}$ " (60 mm) – available*

(*) Sold separately
- Spring Latch** • Stainless steel, 1/2" (12.7 mm) throw
- Faceplate**
 - Mortise type, square corners
 - 1 $\frac{1}{8}$ x 2 $\frac{1}{4}$ " (28.5 x 57 mm)
- Strike** • ASA Strike

- Trim**
 - Solid, pressure cast heavy duty lever
 - Brass rose
 - Rose diameter: 3 $\frac{3}{8}$ " (85.7 mm)
- Chassis**
 - Concealed mounting plate and screws
 - Removable security posts
- Preparation**
 - Cross bore: 2 $\frac{1}{8}$ " (54 mm)
 - Edge bore: 1" (25.4 mm)
- Cylinder**
 - Solid brass, 6-pin
 - Schlage "C" keyway, 2 keys
 - Removable, rekeyable

Other keyways and keying options available, including CX5 high security.
- Functions**

| | |
|--------------------------|------------------------|
| 10 Passage | 53 Entry |
| 17 Dummy, single | 53I Entry w/ indicator |
| 42 Privacy | 70 Classroom |
| 42I Privacy w/ indicator | 80 Storeroom |
- Lever Styles** H–Standard return
- Finish** 26D–Satin chrome

| | | | | |
|--------|-------|----------|---|--------|
| RW | H | 53 | - | C26D |
| SERIES | STYLE | FUNCTION | | FINISH |

(1) OPTION:

SELECTION GUIDE

| SERIES | STYLE | FUNCTION ¹ | FINISH | / CASE |
|--------|-------|-----------------------------|--------|--------|
| RW | H | 10 Passage | 26D | 10 |
| RW | H | 17 Dummy, single | 26D | 20 |
| RW | H | 42 Privacy | 26D | 10 |
| RW | H | 42I Privacy, with indicator | 26D | 10 |
| RW | H | 53 Entry ↔ | 26D | 10 |
| RW | H | 53I Entry, with indicator ↔ | 26D | 10 |
| RW | H | 70 Classroom ↔ | 26D | 10 |
| RW | H | 80 Storeroom ↔ | 26D | 10 |

(1) OTHER FUNCTIONS AVAILABLE, MINIMUM ORDER QUANTITIES AND/OR ADDITIONAL DELIVERY TIMES MAY BE REQUIRED.

↔ KEYED FUNCTION; FULL KEYING SERVICES AVAILABLE.

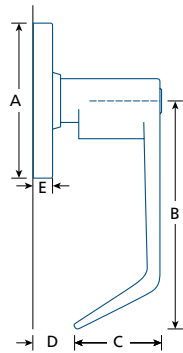

| | | A | B | C | D | E |
|-----------------|---|---|--|---------------------------------------|--|--|
| RW | Ⓛ | 3 ³ / ₈ (85.7) | 4 ³ / ₄ (120) | 2 ¹ / ₈ (54) | 7 ¹ / ₁₆ * (11) | 3 ³ / ₈ (9.5) |
| RW Indicator | Ⓛ | 3 ³ / ₈ (85.7) | 4 ³ / ₄ (120) | 2 ¹ / ₈ (54) | 7 ¹ / ₁₆ (11) | 9 ¹ / ₁₆ (14.3) |

IN (MM) (*) DIMENSION MAY VARY DUE TO DOOR THICKNESS.

PARTS & ACCESSORIES



9106
T-Strike, square corners:
1¹/₈x 2³/₄" (28.5x 70 mm)



ASA
ASA strike



CWAL-01
Passage latch: 2³/₈" (60 mm) backset,
1¹/₈x 2¹/₄" (28.5x 57 mm) faceplate



CWAL-05
Deadlatch: 2³/₈" (60 mm) backset,
1¹/₈x 2¹/₄" (28.5x 57 mm) faceplate





- Type** • Cylindrical lock
- Certifications**
 - Conforms to ANSHI/BHMA A156.2, Series 4000, Grade 2
 - cULus listed, 3hr fire-rating
 - UL 10C Positive Pressure Rating
 - Meets ADA requirements
 - 1 Year limited warranty
- Door Thickness** • 1³/₈ – 1³/₄" (35–45 mm)
- Handing** • Non handed
- Backset**
 - 2³/₄" (70 mm)
 - 2³/₈" (60 mm) – available
- Spring Latch** • Stainless steel, 1/2" (12.7 mm) throw
- Faceplate**
 - Mortise type, square corners
 - 1¹/₈ x 2¹/₄" (28.5 x 57 mm)
- Strike** • ASA Strike
- Trim**
 - Solid, pressure cast heavy duty lever
 - Brass rose
 - Rose diameter: 3" (76 mm)

- Chassis** • Concealed mounting plate and screws
- Preparation**
 - Cross bore: 2¹/₈" (54 mm)
 - Edge bore: 1" (25.4 mm)
- Cylinder**
 - Solid brass, 6-pin
 - Schlage "C" keyway, 2 keys
 - Removable, rekeyable



Other keyways and keying options available, including CX5 high security.
- Functions**

| | |
|------------------|--------------|
| 10 Passage | 53 Entry |
| 17 Dummy, single | 70 Classroom |
| 42 Privacy | 80 Storeroom |
- Lever Styles** H–Standard return
- Finish** 26D–Satin chrome

| | | | | | |
|--------|-------|----------|---|--------|---------------------|
| CW | H | 53 | - | C26D | 238 |
| SERIES | STYLE | FUNCTION | | FINISH | OPTION ¹ |

(1) OPTION: 238 2-3/8IN (60MM) BACKSET

SELECTION GUIDE

| SERIES | STYLE | FUNCTION ¹ | FINISH | / CASE |
|--------|-------|--|--------|--------|
| CW | H | 10 Passage | 26D | 10 |
| CW | H | 17 Dummy, single | 26D | 20 |
| CW | H | 42 Privacy | 26D | 10 |
| CW | H | 53 Entry  | 26D | 10 |
| CW | H | 70 Classroom  | 26D | 10 |
| CW | H | 80 Storeroom  | 26D | 10 |

(1) OTHER FUNCTIONS AVAILABLE, MINIMUM ORDER QUANTITIES AND/OR ADDITIONAL DELIVERY TIMES MAY BE REQUIRED.

 KEYED FUNCTION; FULL KEYING SERVICES AVAILABLE.

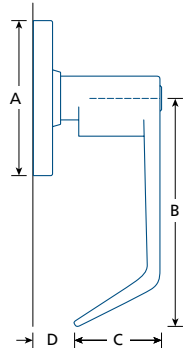

| | A | B | C | D* |
|--|-----------|--|--|---------------|
| CWH  | 3 (76) | 4 ³ / ₄ (120) | 2 ¹ / ₁₆ (52) | 1/2 (12.7) |

IN (MM)

(* DIMENSION MAY VARY DUE TO DOOR THICKNESS.

PARTS & ACCESSORIES



9106
T-Strike, square corners:
1¹/₈x 2³/₄" (28.5x 70 mm)



ASA
ASA strike



CWAL-01
Passage latch: 2³/₈" (60 mm) backset,
1¹/₈x 2¹/₄" (28.5x 57 mm) faceplate



CWAL-05
Deadlatch: 2³/₈" (60 mm) backset,
1¹/₈x 2¹/₄" (28.5x 57 mm) faceplate





- Type** • Cylindrical lock
- Certifications**
 - Conforms to ANSI/BHMA A156.2, Series 4000, Grade 2
 - cULus listed, 3hr fire-rating
 - UL 10C Positive Pressure Rating
 - Meets ADA requirements
 - 1 Year limited warranty
- Door Thickness** • 1³/₈ – 1³/₄" (35–44.5 mm)
- Handing** • Non handed
- Backset**
 - 2³/₄" (70 mm)
 - 2³/₈" (60 mm) – available
 - 3³/₄" (95 mm) – available
 - 5" (127 mm) – available
- Spring Latch** • Stainless steel, 1/2" (12.7 mm) throw
- Faceplate**
 - Mortise type, square corners
 - 1¹/₈ x 2¹/₄" (28.5 x 57 mm)
 - 2³/₈" (60 mm) backset: 1 x 2¹/₄" (25.4 x 57 mm)
- Strike** • ASA Strike
- Trim**
 - Solid, pressure cast lever
 - Brass rose
 - Rose diameter: 3" (76 mm)

- Chassis**
 - Concealed mounting plate and screws
 - Removable security posts
- Preparation**
 - Cross bore: 2¹/₈" (54 mm)
 - Edge bore: 1" (25.4 mm)
- Cylinder**
 - Solid brass, 6-pin
 - Schlage "C" keyway, 2 keys
 - Removable, rekeyable

Other keyways and keying options available, including CX5 high security
- Functions**

| | |
|-----------------------|---------------------|
| 10 Passage | 60 Store |
| 15 Exit | 70 Classroom |
| 17 Dummy, single | 79 Institution exit |
| 42 Privacy | 80 Storeroom |
| 52 Entry ¹ | 82 Institution |
| 53 Entry | |

(1) See selection guide for details

Lever Styles M–Standard, return

Finish C15–Satin nickel
C3–Polished brass

Other finishes available by special order

| | | | | |
|--------|-------|----------|--------|---------------------|
| E | M | 53 | C15 | 238 |
| SERIES | STYLE | FUNCTION | FINISH | OPTION ¹ |

(1) OPTIONS: 238 2-3/8IN (60MM) BACKSET

SELECTION GUIDE

| SERIES | FUNCTION ¹ | FINISH ¹ | / CASE |
|--------|--|---------------------|--------|
| EM | 10 Passage | C15, C3 | 10 |
| EM | 15 Exit | C15 | 10 |
| EM | 17 Dummy, single | C15, C3 | 20 |
| EM | 42 Privacy | C15, C3 | 10 |
| EM | 52 Entry, locking slotted push button ↔ | C15, C3 | 10 |
| EM | 53 Entry, locking thumb-turn push button ↔ | C15, C3 | 10 |
| EM | 53LC Entry, less core ↔ | C15, C3 | 10 |
| EM | 60 Store ↔ | C15 | 10 |
| EM | 70 Classroom ↔ | C15, C3 | 10 |
| EM | 79 Institution exit ↔ | C15 | 10 |
| EM | 80 Storeroom ↔ | C15, C3 | 10 |
| EM | 82 Institution ↔ | C15 | 10 |

(1) OTHER FINISHES AND FUNCTIONS AVAILABLE, MINIMUM ORDER QUANTITIES AND/OR ADDITIONAL DELIVERY TIMES MAY BE REQUIRED

↔ KEYED FUNCTION; FULL KEYING SERVICES AVAILABLE

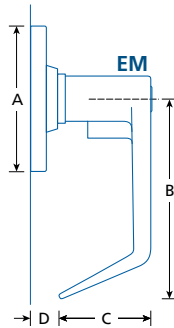

| | A | B | C | D* |
|----|-----------|------------|--------------|--------------|
| EM | 3 (76) | 4 (102) | 17/8 (48) | 7/16 (11) |

IN (MM) (*) DIMENSION MAY VARY DUE TO DOOR THICKNESS.

PARTS & ACCESSORIES



9106
T-Strike, square corners:
1 1/8 x 2 3/4" (28.5 x 70 mm)



9106NH
T-Strike, no hole; square corners:
1 1/8 x 2 3/4" (28.5 x 70 mm)

ASA-T
ASA Strike, adjustable tab; square corners

ASANH
ASA T-Strike, no hole; square corners



TL020
Plastic spacer for latches with 1 x 2 1/4" (25.4 x 57 mm) faceplate to fit preparations for 1 1/8 x 2 1/4" (28.5 x 57 mm) faceplates



TL013
Backset extension to 3 3/4" (95 mm);
Use with 2 3/8" (60 mm) backset latch

TL014
Backset extension to 5" (127 mm);
Use with 2 3/4" (70 mm) backset latch



TL001
Passage latch: 2 3/8" (60 mm) backset,
1 x 2 1/4" (25.4 x 57 mm) faceplate

TL003
Passage latch: 2 3/4" (70 mm) backset,
1 1/8 x 2 1/4" (28.5 x 57 mm) faceplate

TL010
Privacy latch: 2 3/8" (60 mm) backset,
1 x 2 1/4" (25.4 x 57 mm) faceplate

TL002
Privacy latch: 2 3/4" (70 mm) backset,
1 1/8 x 2 1/4" (28.5 x 57 mm) faceplate



TL005
Deadlatch 2 3/8" (60 mm) backset
1 x 2 1/4" (25.4 x 57 mm) faceplate

TL004
Deadlatch: 2 3/4" (70 mm) backset,
1 1/8 x 2 1/4" (28.5 x 57 mm) faceplate

TL006
Deadlatch: 5" (127 mm) backset,
1 1/8 x 2 1/4" (28.5 x 57 mm) faceplate





- Type** • Cylindrical lock
- Certifications**
 - Certified ANSI/BHMA A156.2, Series 4000, Grade 1
 - cULus listed, 3hr fire-rating
 - UL 10C Positive Pressure Rating
 - 10 Year limited warranty
- Door Thickness**
 - 1³/₈–2" (35–51 mm)
 - SFIC models: 1⁹/₁₆–2" (40–51 mm)
- Handing** • Non handed
- Backset**
 - 2³/₄" (70 mm)
 - 2³/₈" (60 mm) – available
 - 3³/₄" (95 mm) – available
 - 5" (127 mm) – available
- Spring Latch**
 - Stainless steel, 1/2" (12.7 mm) throw
 - Deadlatch, 3/4" (19 mm) throw – available
- Faceplate**
 - Mortise type, square corners
 - 1¹/₈x2¹/₄" (28.5x57 mm)
- Strike** • ASA Strike
- Trim**
 - Stainless steel knob
 - Stainless steel rose
 - Rose diameter: 2¹⁵/₁₆" (74.6 mm)

- Chassis**
 - Concealed mounting plate and screws
 - Removable security posts
- Preparation**
 - Cross bore: 2¹/₈" (54 mm)
 - Edge bore: 1" (25.4 mm)
- Cylinder**
 - Solid brass, 6-pin
 - Schlage "C" keyway, 2 keys
 - Removable, rekeyable
 - Small format interchangeable core (SFIC) model – available*

Other keyways and keying options available, including CX5 high security. () BEST® and CX5® cores sold separately.*

| | | |
|------------------|-------------------|---------------------|
| Functions | 10 Passage | 70 Classroom |
| | 42 Privacy | 80 Storeroom |
| | 53 Entry | |
| | 60 Store | |

Finish C32D–Stainless steel

Other finishes available by special order

| | | |
|-------------|-----------|-------------|
| GX1B | 53 | C32D |
| SERIES | FUNCTION | FINISH |

SELECTION GUIDE

| SERIES | FUNCTION ¹ | FINISH ¹ | /CASE |
|--------|----------------------------------|---------------------|-------|
| GX1B | 10 Passage | C32D | 6 |
| GX1B | 42 Privacy | C32D | 6 |
| GX1B | 53 Entry ↔ | C32D | 6 |
| GX1B | 53IC Entry SFIC, less core ↔ | C32D | 6 |
| GX1B | 60 Store ↔ | C32D | 6 |
| GX1B | 60IC Store SFIC, less core ↔ | C32D | 6 |
| GX1B | 70 Classroom ↔ | C32D | 6 |
| GX1B | 70IC Classroom SFIC, less core ↔ | C32D | 6 |
| GX1B | 80 Storeroom ↔ | C32D | 6 |
| GX1B | 80IC Storeroom SFIC, less core ↔ | C32D | 6 |

(1) OTHER FINISHES AND FUNCTIONS AVAILABLE, MINIMUM ORDER QUANTITIES AND/OR ADDITIONAL DELIVERY TIMES MAY BE REQUIRED

↔ KEYED FUNCTION; FULL KEYING SERVICES AVAILABLE

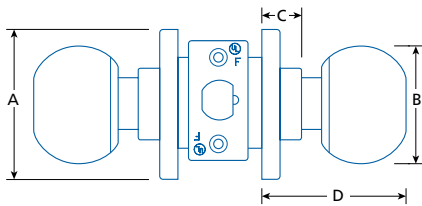

| | A | B | C | D* |
|---|---|---------------------------------------|--|---|
| GX1B  | 2 ¹⁵ / ₁₆ (74.6) | 2 ¹ / ₄ (57) | 1 ³ / ₁₆ (21) | 2 ⁵ / ₈ -3 (67-76) |
| IN (MM) | (*) DIMENSION MAY VARY DUE TO DOOR THICKNESS. | | | |

PARTS & ACCESSORIES



9106

T-Strike, square corners:
1¹/₈x2³/₄" (28.5x70 mm)

9106NH

T-Strike, no hole; square corners:
1¹/₈x2³/₄" (28.5x70 mm)



ASA-T

ASA strike with adjustable tab

ASANH

ASA strike, no hole



9807

CX5 high security SFIC core, 7 pin, 0 bitted

CX5-TPICB

GX1B tailpiece for use with CX5 SFIC cores

CBI-BF6KD-26D

BEST® F type SFIC core, 6 pin, keyed different

CBI-BF7KD-26D

BEST® F type SFIC core, 7 pin, keyed different

TPICB

Knob tailpiece for use with CX5 SFIC cores



GX1SL238

Passage latch: 2³/₈" (60 mm) backset
1¹/₈x2¹/₄" (28.5x57 mm) faceplate

GX1SL234

Passage latch: 2³/₄" (70 mm) backset
1¹/₈x2¹/₄" (28.5x57 mm) faceplate

GX1PL238

Privacy latch: 2³/₈" (60 mm) backset
1¹/₈x2¹/₄" (28.5x57 mm) faceplate

GX1PL234

Privacy latch: 2³/₄" (70 mm) backset
1¹/₈x2¹/₄" (28.5x57 mm) faceplate



GX1DL238

Deadlatch: 2³/₈" (60) backset
1¹/₈x2¹/₄" (28.5x57 mm) faceplate

GX1DL234

Deadlatch: 2³/₄" (70 mm) backset
1¹/₈x2¹/₄" (28.5x57 mm) faceplate



GX1DL234-34

Deadlatch: 2³/₄" (70 mm) backset, ³/₄" (19 mm) throw, 1¹/₈x2¹/₄" (28.5x57 mm) faceplate
For use in double door or electric strike applications



GX1LE334

Backset extension to 3³/₄" (95 mm); use with 2³/₈" (60 mm) backset latch

GX1LE500

Backset extension to 5" (127 mm); use with 2³/₄" (70 mm) backset latch





- Type** • Cylindrical lock
 - Certifications**
 - Conforms to ANSI/BHMA A156.2, Series 4000, Grade 2
 - cULus listed, 3hr fire-rating
 - UL 10C Positive Pressure Rating
 - 5 Year limited warranty
 - Door Thickness** • 1³/₈–1³/₄" (35–44.5 mm)
 - Handing** • Non handed
 - Backset**
 - 2³/₄" (70 mm)
 - 2³/₈" (60 mm) – available
 - 3³/₄" (95 mm) – available
 - 5" (127 mm) – available
 - Spring Latch** • Stainless steel, 1/2" (12.7 mm) throw
 - Faceplate**
 - Mortise type, square corners
 - 1¹/₈x2¹/₄" (28.5x57 mm)
 - 2³/₈" (60 mm) backset: 1x2¹/₄" (25.4x57mm)
 - Strike** • ASA Strike
 - Trim**
 - Brass or stainless steel knob*
 - Brass or stainless steel rose*
 - Rose diameter: 3" (76 mm)
- (*) Material dependant on finish.

- Chassis** • Concealed mounting plate and screws
 - Preparation**
 - Cross bore: 2¹/₈" (54 mm)
 - Edge bore: 1" (25.4 mm)
 - Cylinder**
 - Solid brass, 6-pin
 - Schlage "C" keyway, 2 keys
 - Removable, rekeyable

Other keyways and keying options available, including CX5 high security
 - Functions**

| | |
|------------------|------------------------|
| 10 Passage | 60 Store |
| 15 Exit | 70 Classroom |
| 17 Dummy, single | 79 Institution exit |
| 32 Patio | 80 Storeroom* |
| 42 Privacy | 82 Institution/utility |
| 53 Entry* | |

(*) Available without core cylinder (LC)
 - Finish** C3–Polished brass, C32D–Stainless steel
- Other finishes available by special order*

| TL | 53 | B | C32D | 238 |
|--------|----------|-------|--------|---------------------|
| SERIES | FUNCTION | STYLE | FINISH | OPTION ¹ |

(1) OPTION: 238 2-3/8IN (60MM) BACKSET LC–LESS CORE (53 & 80)

SELECTION GUIDE

| SERIES | FUNCTION ¹ | STYLE | FINISH ¹ | / CASE |
|--------|---|-------|---------------------|--------|
| TL | 10 Passage | B | C3, C32D | 20 |
| TL | 15 Exit | B | C3, C32D | 20 |
| TL | 17 Dummy, single | B | C3, C32D | 40 |
| TL | 32 Patio (includes full-lip D-Strike) | B | C32D | 20 |
| TL | 42 Privacy | B | C3, C32D | 20 |
| TL | 53 Entry ↔ | B | C3, C32D | 20 |
| TL | 53 LC Entry, housing only (less core) ↔ | B | C32D | 20 |
| TL | 60 Store ↔ | B | C32D | 20 |
| TL | 70 Classroom ↔ | B | C3, C32D | 20 |
| TL | 79 Institution / exit ↔ | B | C32D | 20 |
| TL | 80 Storeroom ↔ | B | C3, C32D | 20 |
| TL | 80 LC Storeroom, housing only (less core) ↔ | B | C32D | 20 |
| TL | 82 Institution / utility ↔ | B | C32D | 20 |

(1) OTHER FINISHES AND FUNCTIONS AVAILABLE, MINIMUM ORDER QUANTITIES AND/OR ADDITIONAL DELIVERY TIMES MAY BE REQUIRED
 ↔ KEYED FUNCTION; FULL KEYING SERVICES AVAILABLE

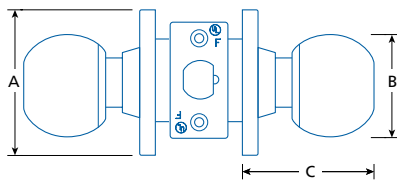

| | A | B | C |
|-------------|-----------|-------------------------|-------------------------|
| TL B | 3 (76) | 2 $\frac{1}{8}$ (57) | 2 $\frac{5}{8}$ (67) |

IN (MM)

PARTS & ACCESSORIES



9102
Full lip D-Strike, adjustable tab; square corners:
1 $\frac{3}{4}$ x2 $\frac{1}{4}$ " (44.5x57 mm)



9106
T-Strike, square corners:
1 $\frac{1}{8}$ x2 $\frac{3}{4}$ " (28.5x70 mm)



9106NH
T-Strike, no hole; square corners:
1 $\frac{1}{8}$ x2 $\frac{3}{4}$ " (28.5x70 mm)



ASA-T
ASA strike, adjustable tab; square corners



ASANH
ASA strike, no hole; square corners



TL020
Plastic spacer for latches with 1 x 2 $\frac{1}{4}$ "
(25.4x57 mm) faceplate to fit preparations
for 1 $\frac{1}{8}$ x2 $\frac{1}{4}$ " (28.5x57 mm) faceplates



TL013
Backset extension to 3 $\frac{3}{4}$ " (95 mm);
Use with 2 $\frac{3}{8}$ " (60 mm) backset latch



TL001
Passage latch: 2 $\frac{3}{8}$ " (60 mm) backset,
1x2 $\frac{1}{4}$ " (25.4x57 mm) faceplate



TL003
Passage latch: 2 $\frac{3}{4}$ " (70 mm) backset,
1 $\frac{1}{8}$ x2 $\frac{1}{4}$ " (28.5x57 mm) faceplate



TL010
Privacy latch: 2 $\frac{3}{8}$ " (60 mm) backset,
1x2 $\frac{1}{4}$ " (25.4x57 mm) faceplate



TL002
Privacy latch: 2 $\frac{3}{4}$ " (70 mm) backset,
1 $\frac{1}{8}$ x2 $\frac{1}{4}$ " (28.5x57 mm) faceplate

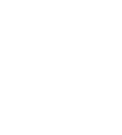

TL005
Deadlatch 2 $\frac{3}{8}$ " (60 mm) backset
1x2 $\frac{1}{4}$ " (25.4x57 mm) faceplate

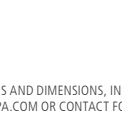

TL004
Deadlatch: 2 $\frac{3}{4}$ " (70 mm) backset,
1 $\frac{1}{8}$ x2 $\frac{1}{4}$ " (28.5x57 mm) faceplate



TL006
Deadlatch: 5" (127 mm) backset,
1 $\frac{1}{8}$ x2 $\frac{1}{4}$ " (28.5x57 mm) faceplate

TL011 (for function 32 or 94)
Deadlatch: 2 $\frac{3}{8}$ " (60 mm) backset,
1x2 $\frac{1}{4}$ " (25.4x57 mm) faceplate

TL012 (for function 32 or 94)
Deadlatch: 2 $\frac{3}{4}$ " (70 mm) backset,
1 $\frac{1}{8}$ x2 $\frac{1}{4}$ " (28.5x57 mm) faceplate





- Type** • Cylindrical lock
 - Certifications**
 - Conforms to ANSI/BHMA A156.2, Series 4000, Grade 2
 - cULus listed, 3hr fire-rating
 - UL 10C Positive Pressure Rating
 - 10 Year limited warranty
 - Door Thickness** • 1³/₈–2¹/₄" (35–57 mm)
 - Handing** • Non handed
 - Backset**
 - 2³/₄" (70 mm)
 - 2³/₈" (60 mm) – available
 - 3³/₄" (95 mm) – available
 - 5" (127 mm) – available
 - Spring Latch** • Stainless steel, 1/2" (12.7 mm) throw
 - Faceplate**
 - Mortise type, square corners
 - 1¹/₈x2¹/₄" (28.5x57 mm)
 - 2³/₈" (60 mm) backset : 1 x 2¹/₄" (25.4x57mm)
 - Strike** • ASA Strike
 - Trim**
 - Brass or stainless steel knob*
 - Brass or stainless steel rose*
 - Rose diameter: 3" (76 mm)
- (*) Material dependant on finish.

- Chassis** • Concealed mounting plate and screws
 - Preparation**
 - Cross bore: 2¹/₈" (54 mm)
 - Edge bore: 1" (25.4 mm)
 - Cylinder**
 - Solid brass, 6-pin
 - Schlage "C" keyway, 2 keys
 - Removable, rekeyable

Other keyways and keying options available.
 - Functions**







| | |
|------------------|---------------|
| 00 Dummy, single | 70 Classroom* |
| 10 Passage | 80 Storeroom* |
| 40 Privacy | 89 Exit |
| 53 Entry* | |

(*) Available without core cylinder (LC)
 - Finish** C32D–Stainless steel
- Other finishes available by special order*

| T2B | 53 | C32D | 238 |
|--------|----------|--------|---------------------|
| SERIES | FUNCTION | FINISH | OPTION ¹ |

(1) OPTION: 238 2-3/8IN (60MM) BACKSET LC-LESS CORE (53 & 80)

SELECTION GUIDE

| SERIES | FUNCTION ¹ | FINISH ¹ | / CASE |
|--------|---|---------------------|--------|
| T2B | 00 Dummy, single | C32D | 100 |
| T2B | 10 Passage | C32D | 20 |
| T2B | 40 Privacy | C32D | 20 |
| T2B | 53 Entry  | C32D | 20 |
| T2B | 53 LC Entry, housing only (less core)  | C32D | 20 |
| T2B | 70 Classroom  | C32D | 20 |
| T2B | 70 LC Classroom, housing only (less core)  | C32D | 20 |
| T2B | 80 Storeroom  | C32D | 20 |
| T2B | 80 LC Storeroom, housing only (less core)  | C32D | 20 |
| T2B | 89 Exit | C32D | 20 |

(1) OTHER FINISHES AND FUNCTIONS AVAILABLE, MINIMUM ORDER QUANTITIES AND/OR ADDITIONAL DELIVERY TIMES MAY BE REQUIRED

 KEYED FUNCTION; FULL KEYING SERVICES AVAILABLE

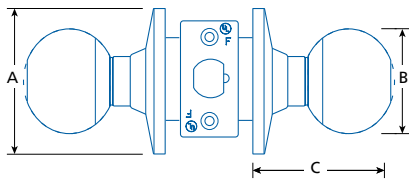

| | A | B | C* |
|-------------------------|-----------|---------------------------------------|--|
| B (NON KEYED) | 3 (76) | 2 ¹ / ₈ (54) | 2 ⁵ / ₈ -3 ¹ / ₁₆ (67-78) |
| B (KEYED) | | | 2 ⁹ / ₁₆ -3 (65-76) |

IN (MM) (*) DIMENSION VARIES WITH DOOR THICKNESS.

PARTS & ACCESSORIES



9102
Full lip D-Strike, adjustable tab; square corners:
1³/₄x2¹/₄" (44.5x57 mm)



9106
T-Strike, square corners:
1¹/₈x2³/₄" (28.5x70 mm)



9106NH
T-Strike, no hole; square corners:
1¹/₈x2³/₄" (28.5x70 mm)



ASA-T
ASA strike, adjustable tab; square corners



ASANH
ASA strike, no hole; square corners



TL020
Plastic spacer for latches with 1 x 2¹/₄"
(25.4x57 mm) faceplate to fit preparations
for 1¹/₈x2³/₄" (28.5x57 mm) faceplates



TL013
Backset extension to 3³/₄" (95 mm);
Use with 2³/₈" (60 mm) backset latch



TL014
Backset extension to 5" (127 mm);
Use with 2³/₄" (70 mm) backset latch Use with
2³/₄" (70 mm) backset latch



TL001
Passage latch: 2³/₈" (60 mm) backset,
1x2¹/₄" (25.4x57 mm) faceplate



TL003
Passage latch: 2³/₄" (70 mm) backset,
1¹/₈x2¹/₄" (28.5x57 mm) faceplate



TL010
Privacy latch: 2³/₈" (60 mm) backset,
1x2¹/₄" (25.4x57 mm) faceplate



TL002
Privacy latch: 2³/₄" (70 mm) backset,
1¹/₈x2¹/₄" (28.5x57 mm) faceplate



TL005
Deadlatch 2³/₈" (60 mm) backset
1x2¹/₄" (25.4x57 mm) faceplate



TL004
Deadlatch: 2³/₄" (70 mm) backset,
1¹/₈x2¹/₄" (28.5x57 mm) faceplate



TL006
Deadlatch: 5" (127 mm) backset,
1¹/₈x2¹/₄" (28.5x57 mm) faceplate





IL80EMC15KDS shown,
Storeroom, double lock

- Type** • Interconnected cylindrical lock
- Certifications**
 - Conforms to ANSI/BHMA A156.12, Grade 2
 - cULus listed, 3 hour fire-rating
 - UL10C Positive Pressure Rating
 - Meets ADA requirements
 - 1 Year limited warranty
- Door Thickness** • 1³/₈–1³/₄" (35–44.5 mm)
- Handing** • Non handed
- Backset**
 - 2³/₄" (70 mm)
 - 2³/₈" (60 mm) – available
- Spring Latch**
 - Stainless steel
 - 1/2" (12.7 mm) throw
- Deadbolt**
 - Solid brass with hardened steel security pin
 - 1" (25.4 mm) throw
- Faceplate**
 - Mortise type, square corners
 - 1¹/₈x2¹/₄" (28.5x57 mm)
- Strikes**
 - T-Strike: 1¹/₈x2³/₄" (28.5x70 mm)
 - Deadbolt strike: 1¹/₈x2³/₄" (28.5x70 mm)
 - Plastic dust-boxes
- Interior**
 - Square (S): 8x3¹/₈" (203x79 mm)
- Escutcheon**
 - Round (R): 8⁷/₈x3¹/₈" (225x79 mm)

- Exterior**
 - Square: 8x3¹/₈" (203x79 mm)
- Escutcheon**
 - Round: 8⁷/₈x3¹/₈" (225x79 mm)
 - Not included, sold separately*
- Chassis**
 - Free-spinning deadbolt cylinder collar
 - Steel deadbolt cylinder housing
 - Exposed mounting screws
 - Single action egress
- Preparation**
 - 4" (102 mm) centre-to-centre installation
 - Cross bore: 2¹/₈" (54 mm)
 - Edge bore: 1" (25.4 mm)
- Cylinder**
 - Solid brass, 6-pin
 - Schlage "C" keyway, 2 keys
 - Removable, rekeyable
 - Other keyways and keying options available, including CX5 high security*
- Functions**
 - 10 Passage, single lock
 - 80 Storeroom, double lock
- Lever Styles** EM–Standard return
 - Other lever styles available by special order*
- Finish** C15–Satin nickel
 - Other finishes available by special order*

| IL | 10 | EM | C15 | KD | S | 238 |
|--------|----------|-------|--------|--------|------|---------------------|
| SERIES | FUNCTION | STYLE | FINISH | KEYING | TRIM | OPTION ¹ |

(1) OPTIONS: 238 2-3/8IN (60MM) BACKSET

SELECTION GUIDE

| SERIES | FUNCTION | LEVER | INTERIOR TRIM | FINISH | /CASE |
|--------|---------------------------------|-------|---------------|--------|-------|
| IL | 10 Passage, single lock entry | EM | R, S | C15 | 10 |
| IL | 80 Storeroom, double lock entry | EM | S | C15 | 10 |

OTHER FINISHES AND FUNCTIONS AVAILABLE, MINIMUM ORDER QUANTITIES AND/OR ADDITIONAL DELIVERY TIMES MAY BE REQUIRED EXTERIOR ESCUTCHEON SOLD SEPARATELY
 ☞ KEYED FUNCTION; FULL KEYING SERVICES AVAILABLE

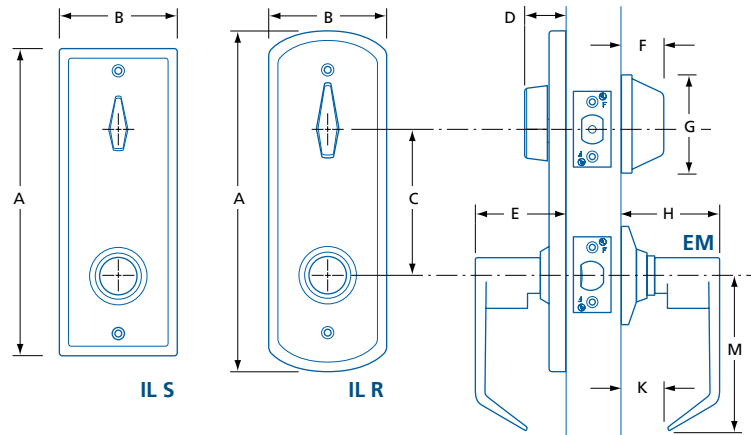

| | | A | B | C | D | E | F | G | H* | K* | M | P |
|------|----|--|---------------------------------------|--------------|--|--|--|--|--|--|------------|--|
| IL R | EM | 8 ⁷ / ₈ (225.4) | 3 ¹ / ₈ (79) | 4 (101.6) | 1 ¹ / ₁₆ (27) | 2 ⁹ / ₁₆ (65) | 1 ¹ / ₁₆ (27.2) | 2 ⁹ / ₁₆ (65) | 2 ⁵ / ₁₆ (59) | 3 ³ / ₈ (9.5) | 4 (102) | 2 ⁹ / ₁₆ (65) |
| IL S | EM | 8 (203.2) | 3 ¹ / ₈ (79) | 4 (101.6) | 1 ¹ / ₁₆ (27) | 2 ¹ / ₈ (54) | 1 ¹ / ₁₆ (27.2) | 2 ⁹ / ₁₆ (65) | 2 ⁵ / ₁₆ (59) | 3 ³ / ₈ (9.5) | 4 (102) | 2 ⁹ / ₁₆ (65) |

IN (MM) (*) DIMENSION MAY VARY DUE TO DOOR THICKNESS NOTE: EXTERIOR ESCUTCHEON PLATES ARE THE SAME SIZE AS THE INTERIOR ONES (SOLD SEPARATELY)

PARTS & ACCESSORIES



ILPRC15
 Exterior escutcheon, round
 8⁷/₈ x 3¹/₈ x 7¹/₁₆" (225 x 79 x 11 mm)
 Not included



ILPSC15
 Exterior escutcheon, square
 8 x 3¹/₈ x 7¹/₁₆" (203 x 79 x 11 mm)
 Not included





LS
Square rose

- Type** • Interconnected tubular lock
- Certifications**
- Conforms to ANSI/BHMA A156.12, Grade 2
 - cULus listed, 3 hour fire-rating
 - UL10C Positive Pressure Rating
 - Lever meets ADA requirements
 - 1 Year limited warranty
- Door Thickness** • 1¾–2½" (45–55 mm)
- Handing** • Non handed
- Backset** • 2¾ – 2¾" (60–70 mm), adjustable
- Spring Latch**
- Stainless steel
 - ½" (12.5 mm) throw
- Deadbolt**
- Steel with hardened steel security pin
 - 1" (25.4 mm) throw
- Faceplate**
- Mortise type, square corners
 - 1½x2¼" (28.5x57 mm)
- Strikes**
- T-Strike: 1½x2¾" (28x70 mm)
 - Deadbolt strike: 1½x2¾" (28x70 mm)
 - Plastic dust-boxes

- Interior Escutcheon** • 8½x2¾" (216x70 mm)
- Chassis**
- Concealed mounting screws
 - Visible lever set-screws
 - Single action egress
- Preparation**
- 5½" (140 mm) centre-to-centre installation
 - Cross bore: 2½" (54 mm)
 - Edge bore: 1" (25.4 mm)
- Cylinder**
- Solid brass, 6-pin
 - Schlage "C" keyway, 2 keys
- Function** 55 Suite entry, single lock, with single action egress
- Lever Styles** L–Lina, LS–Lina (square rose)
Other lever styles available by special order
- Finish** 15–Satin nickel, 19–Matte black
Other finishes available by special order

| | | | | | | |
|--------|----------|-------|--------|--------|-------|---|
| T2IL | 55 | L | - | 15 | KD | M |
| SERIES | FUNCTION | STYLE | FINISH | KEYING | LATCH | |

SELECTION GUIDE

| SERIES | FUNCTION | LEVER | FINISH | /CASE |
|--------|--|-------|--------|-------|
| T2 IL | 55 Suite entry, single lock, with single action egress  | L, LS | 15, 19 | 10 |

OTHER FINISHES AND FUNCTIONS AVAILABLE, MINIMUM ORDER QUANTITIES AND/OR ADDITIONAL DELIVERY TIMES MAY BE REQUIRED
 KEYED FUNCTION

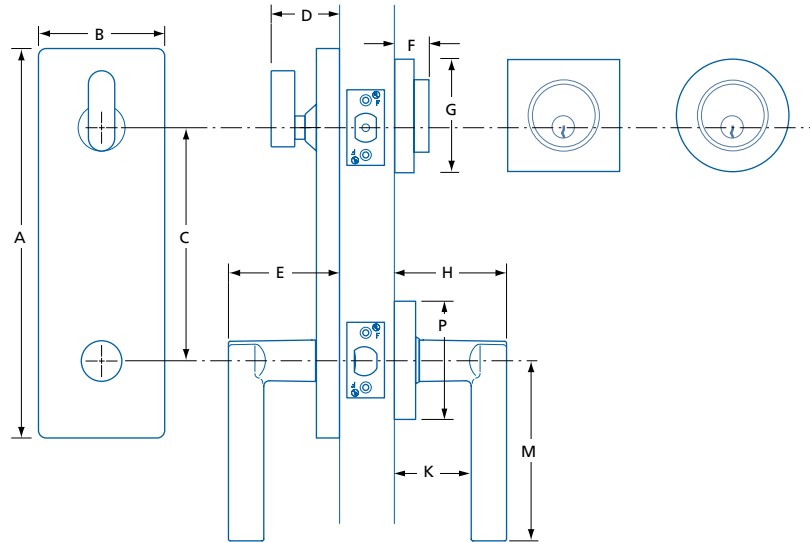

| | A | B | C | D | E | F | G | H | K | M | P |
|--------------|-------------|------------|-------------|------------|--------------|-----------|--------------|--------------|--------------|--------------|--------------|
| T2 IL | 8½ (216) | 2¾ (70) | 5½ (140) | 1½ (38) | 2½ (63.5) | ¾ (19) | 2½ (63.5) | 2½ (63.5) | 1⅝ (41.3) | 4 (101.6) | 2½ (63.5) |

IN (MM)





- Certifications**
- Conforms to ANSI/BHMA A156.36, Grade 1
 - cULus listed, 3hr fire-rating
 - 10 Year limited warranty
- Door Thickness**
- 1 $\frac{1}{16}$ –2" (40–51 mm)
 - Kit for 2 $\frac{1}{4}$ " (57 mm) – available
- Handing**
- Non handed
- Backset**
- 2 $\frac{3}{4}$ " (70 mm)
 - 2 $\frac{3}{8}$ " (60 mm) – available
- Deadbolt**
- Solid brass with hardened steel security pin
 - 1" (25.4 mm) throw
- Faceplate**
- Mortise type, square corners
 - 1 $\frac{1}{8}$ x2 $\frac{1}{4}$ " (29x57 mm)
- Strikes**
- Wood & steel frame strikes; square corners
 - 1 $\frac{1}{8}$ x2 $\frac{3}{4}$ " (29x70 mm)
 - Plastic dust-box
- Other strikes available*
- Chassis**
- Free-spinning cylinder collar
 - Steel cylinder housing
 - Concealed mounting screws

- Preparation**
- Cross bore: 2 $\frac{1}{8}$ " (54 mm)
 - Edge bore: 1" (25.4 mm)
- Cylinder**
- Solid brass, 6-pin
 - Schlage "C" keyway, 2 keys
 - Removable, rekeyable
 - Small format interchangeable core (SFIC) model – available*
- Other keyways and keying options available, including CX5 high security. (*) BEST® and CX5® cores sold separately.*
- Functions**
- 51 Single cylinder, thumb-turn
 - 60 Double cylinder
 - 70 Single cylinder, thumb-turn (Classroom)
- Less Core (LC) available – see selection guide*
- Finish**
- C15–Satin nickel, C15A–Antique nickel, C26D–Satin chrome, C3–Polished brass, V3–Polished brass (Endurance)
- Other finishes available by special order*

| GX1A | 51 | C26D | LC |
|--------|----------|--------|-----------------------|
| SERIES | FUNCTION | FINISH | OPTION ⁽¹⁾ |

(1) OPTIONS: 238-2 3/8IN (60MM) BACKSET LC-LESS CORE (51 ONLY) WEI-WEISER KEYWAY

SELECTION GUIDE

| SERIES | FUNCTION ¹ | FINISH ¹ | /CASE |
|--------|--|-----------------------------|-------|
| GX1A | 51 Single cylinder, thumb-turn ↔ | C15, C15A, C26D, C3, C5, V3 | 12 |
| GX1A | 51 LC Single cylinder, thumb-turn, less core ↔ | C26D | 12 |
| GX1A | 51 WEI Single cylinder, thumb-turn, 5-pin Weiser keyway ↔ | C26D, C3, C5 | 12 |
| GX1A | 51 IC Single cylinder SFIC, thumb-turn, 7-pin BEST® F core included ↔ | C15, C26D | 12 |
| GX1A | 60 Double cylinder ↔ | C26D | 12 |
| GX1A | 60IC Double cylinder SFIC, 7-pin BEST® F core included ↔ | C26D | 12 |
| GX1A | 70 Single cylinder, thumb-turn (Classroom) ↔ | C26D | 12 |
| GX1A | 70IC Single cylinder SFIC, thumb-turn, 7-pin BEST® F core included (Classroom) ↔ | C26D | 12 |

(1) OTHER FINISHES AND FUNCTIONS AVAILABLE, MINIMUM ORDER QUANTITIES AND/OR ADDITIONAL DELIVERY TIMES MAY BE REQUIRED
 ↔ KEYED FUNCTION; FULL KEYING SERVICES AVAILABLE

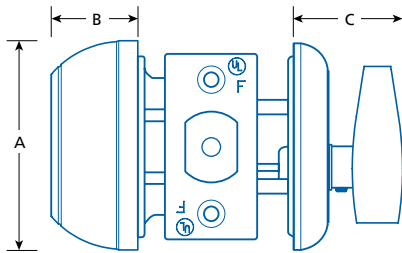

| | A | B | C |
|------|---|--|--|
| GX1A | 2 ¹⁵ / ₃₂ (63) | 1 ¹ / ₁₆ (27) | 1 ⁹ / ₃₂ (32.3) |

IN (MM)

PARTS & ACCESSORIES



9111
Steel frame strike; square.
1¹/₈x2³/₄" (29x70mm)

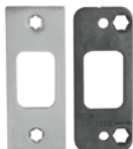

LM9111
Steel (square) and wood (round) frame security strikes.
1¹/₈x2³/₄" (29x70mm)



9118
Wood frame strike; square.
1¹/₈x2³/₄" (29x70mm)

9118R
Wood frame strike; round.
1¹/₈x2³/₄" (29x70mm)



9807
CX5 high security SFIC core, 7 pin, 0 bitted

CBI-BF6KD-26D
BEST® F type SFIC core, 6 pin, 0 bitted

CBI-BF7KD-26D
BEST® F type SFIC core, 7 pin, 0 bitted



TL007
Deadbolt: 2³/₈" (60 mm) backset,
1 x 2¹/₄" (25.4x57 mm) faceplate

TL008
Deadbolt: 2³/₄" (70 mm) backset,
1¹/₈x2¹/₄" (28.5x57 mm) faceplate



TLA85052
Longer spindle and screw kit for 2¹/₄" (57 mm) thick door. For GX1A51 or GX1A70.

TLA93110
Longer spindle and screw kit for 2¹/₄" (57 mm) thick door. For GX1A60.





FHA 421
Privacy with indicator

- Certifications**
 - Conforms to ANSI/BHMA A156.36, Grade 2
 - cULus listed, 3hr fire-rating
 - 1 Year limited warranty
- Door Thickness**
 - 1 $\frac{3}{8}$ –1 $\frac{3}{4}$ " (35–44.5 mm)
- Handing**
 - Non handed
- Backset**
 - 2 $\frac{3}{8}$ –2 $\frac{3}{4}$ " (60–70 mm) adjustable
- Deadbolt**
 - Solid brass with hardened steel security pin
 - 1" (25.4 mm) throw
- Faceplate**
 - Mortise type, square corners
 - 1 $\frac{1}{8}$ x2 $\frac{1}{4}$ " (29x57 mm)
- Strike**
 - 2-piece security strike (wood/metal frame)
 - 1 $\frac{1}{8}$ x2 $\frac{3}{4}$ " (29x70 mm), square corners
 - Plastic dust-box

Other strikes available

- Chassis**
 - Free-spinning cylinder collar
 - Steel cylinder housing
 - Exposed mounting screws
- Preparation**
 - Cross bore: 2 $\frac{1}{8}$ " (54 mm)
 - Edge bore: 1" (25.4 mm)
- Cylinder**
 - Solid brass, 6-pin
 - Schlage "C" keyway, 2 keys
 - Removable, rekeyable

Other keyways and keying options available, including CX5 high security
- Functions**
 - 421 Privacy with indicator
 - 51 Single cylinder, thumbturn
 - 60 Double cylinder
- Finish**
 - C26D–Satin chrome, C3–Polished brass, C19–Matte black

Other finishes available by special order

| | | |
|--------|----------|--------|
| FHA | 51 | C26D |
| SERIES | FUNCTION | FINISH |

SELECTION GUIDE

| SERIES | FUNCTION ¹ | FINISH ¹ | /CASE |
|--------|--------------------------------------|---------------------|-------|
| FHA | 42I Privacy, with indicator* | C26D, C19 | 24 |
| FHA | 51 Single cylinder, with thumbturn ↻ | C26D, C3 | 24 |
| FHA | 60 Double cylinder ↻ | C26D, C3 | 24 |

(1) OTHER FINISHES AND FUNCTIONS AVAILABLE, MINIMUM ORDER QUANTITIES AND/OR ADDITIONAL DELIVERY TIMES MAY BE REQUIRED
 ↻ KEYED FUNCTION; FULL KEYING SERVICES AVAILABLE (*) NOT FIRE-RATED

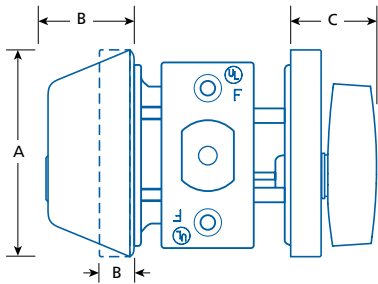

| | A | B | C |
|----------------|---|-------------------------------------|---------------------------------------|
| FHA | 2 ⁹ / ₁₆ (65) | 1 (25.4) | 1 (25.4) |
| FHA 42I | 2 ¹ / ₂ (63.5) | ³ / ₈ (10) | ¹³ / ₁₆ (30) |

IN (MM)

PARTS & ACCESSORIES



9111
Steel frame strike; square.
1¹/₈ x 2³/₄" (29 x 70 mm)



9118
Wood frame strike; square.
1¹/₈ x 2³/₄" (29 x 70 mm)

9118R
Wood frame strike; round.
1¹/₈ x 2³/₄" (29 x 70 mm)





TLA 421
Privacy with indicator



- Certifications**
- Conforms to ANSI/BHMA A156.36, Grade 2
 - cULus listed, 3hr fire-rating*
 - 5 Year limited warranty
- (*) Except privacy model 421

- Door Thickness**
- 1 $\frac{3}{8}$ –1 $\frac{3}{4}$ " (35–44.5 mm)
 - SFIC Model: 1 $\frac{1}{16}$ –2" (40–51 mm)
 - Kit for 2 $\frac{1}{4}$ " (57 mm) – available

- Handing**
- Non handed

- Backset**
- 2 $\frac{3}{4}$ " (70 mm)
 - 2 $\frac{3}{8}$ " (60 mm) – available
 - 2 $\frac{3}{8}$ –2 $\frac{3}{4}$ " (60–70 mm) adjustable – available

- Deadbolt**
- Solid brass with hardened steel security pin
 - 1" (25.4 mm) throw

- Faceplate**
- Mortise type, square corners
 - 1 $\frac{1}{8}$ x2 $\frac{1}{4}$ " (29x57 mm)

- Strike**
- 2-piece security strike (wood/metal frame)
 - 1 $\frac{1}{8}$ x2 $\frac{3}{4}$ " (29x70 mm), square corners
 - Plastic dust-box
- Other strikes available

- Chassis**
- Free-spinning cylinder collar
 - Steel cylinder housing
 - Exposed mounting screws

- Preparation**
- Cross bore: 1 $\frac{1}{2}$ " or 2 $\frac{1}{8}$ " (38 mm or 54 mm)*
 - Edge bore: 1" (25.4 mm)
- (*) 1 $\frac{1}{2}$ " (38 mm) installation will negate Grade 2 conformity, but will retain fire-rating.

- Cylinder**
- Solid brass, 6-pin
 - Schlage "C" keyway, 2 keys
 - Removable, rekeyable
 - Small format interchangeable core (SFIC) model – available
- Other keyways and keying options available, including CX5 high security.

- Functions**
- 421 Privacy with indicator*
 - 51 Single cylinder, thumb-turn
 - 57 Thumb-turn only, exterior plate
 - 60 Double cylinder
 - 70 Single cylinder, thumb-turn (Classroom)
- (*) Emergency unlock by emergency key or flat head screw driver. Emergency key is not included.

- Finish**
- C19–Matte black, C26D–Satin chrome, C3–Polished brass, C32D–Satin stainless steel
- Other finishes available by special order

| TLA | 51 | C32D | -U |
|--------|----------|--------|---------------------|
| SERIES | FUNCTION | FINISH | OPTION ¹ |

(1) OPTIONS: 238–2 3/8IN (60MM) BACKSET -U–ADJUSTABLE BACKSET

SELECTION GUIDE

| SERIES | FUNCTION ¹ | FINISH ¹ | /CASE |
|--------|---|---------------------|-------|
| TLA | 42I Privacy, with indicator* | 26D, 32D | 20 |
| TLA | 51 Single cylinder with thumb-turn ↔ | C19, C26D, C3, C32D | 20 |
| TLA | 51-U Single cylinder with thumb-turn, adjustable backset option ↔ | C26D, C32D | 20 |
| TLA | 51IC Single cylinder with thumb-turn (BEST® F, 7-pin SFIC included) ↔ | C26D, C32D | 20 |
| TLA | 57 Thumb-turn only with blank exterior plate | C26D | 20 |
| TLA | 60 Double cylinder ↔ | C3, C32D | 20 |
| TLA | 60-U Double cylinder, adjustable backset option ↔ | C32D | 20 |
| TLA | 70 Single cylinder, with thumb-turn (Classroom) ↔ | C32D | 20 |

(1) OTHER FINISHES AND FUNCTIONS AVAILABLE, MINIMUM ORDER QUANTITIES AND/OR ADDITIONAL DELIVERY TIMES MAY BE REQUIRED

↔ KEYED FUNCTION; FULL KEYING SERVICES AVAILABLE (*) CANNOT ACCOMMODATE DOORS THICKER THAN 1-3/4IN (44.5 MM); NOT FIRE-RATED

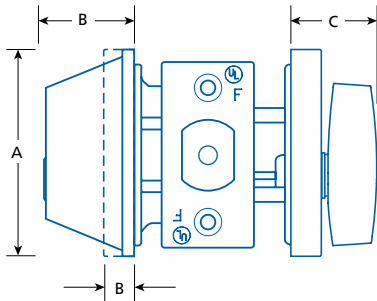

| | ø A | B | C |
|---------|----------------|-----------------|-----------|
| TLA | 2 9/16 (65) | 1 1/8 (29) | 1 (25) |
| TLA 42I | 2 9/16 (65) | 1 1/32 (8.5) | 1 (25) |
| TLA 57 | 2 9/16 (65) | 1 1/32 (8.5) | 1 (25) |

IN (MM)

PARTS & ACCESSORIES



9111
Steel frame strike; square.
1 1/8 x 2 3/4" (29 x 70 mm)



9118
Wood frame strike; square.
1 1/8 x 2 3/4" (29 x 70 mm)

9118R
Wood frame strike; round.
1 1/8 x 2 3/4" (29 x 70 mm)



9807
CX5 high security SFIC core, 7 pin, 0 bitted

CBI-BF6KD-26D
BEST® F type SFIC core, 6 pin, keyed different

CBI-BF7KD-26D
BEST® F type SFIC core, 7 pin, keyed different



TLA42-EKEY
Emergency key for TLA 42I.



TL007
Deadbolt: 2 3/8" (60 mm) backset,
1 x 2 1/4" (25.4 x 57 mm) faceplate

TL008
Deadbolt: 2 3/4" (70 mm) backset,
1 1/8 x 2 1/4" (28.5 x 57 mm) faceplate

TLA-LBU
Deadbolt: 2 3/8-2 3/4" (60-70 mm) adjustable
backset, 1 x 2 1/4" (25.4 x 57 mm) faceplate



TL020
Plastic spacer for latches with 1 x 2 1/4"
(25.4 x 57 mm) faceplate to fit preparations
for 1 1/8 x 2 1/4" (28.5 x 57 mm) faceplates



TLA85052
Longer spindle and screw kit for 2 1/4" (57 mm)
thick door. For TLA 51 or TLA 70 only, cannot
be used with TLA 42I Indicator model.

TLA93110
Longer spindle and screw kit for 2 1/4" (57 mm)
thick door. For TLA 60.





- Certifications**
- Conforms to ANSI/BHMA A156.36, Grade 1
 - cULus listed, 3hr fire-rating
 - 5 Year limited warranty

- Door Thickness**
- 1 $\frac{3}{8}$ –2" (35–51 mm)

- Handing**
- Non handed

- Backset**
- 2 $\frac{3}{4}$ " (70 mm)
 - 2 $\frac{3}{8}$ " (60 mm) – available

- Spring Latch**
- Solid brass deadlatch
 - $\frac{5}{8}$ " (15.9mm) throw

- Faceplate**
- Mortise type, square corners
 - 1 $\frac{1}{8}$ x2 $\frac{1}{4}$ " (29x57 mm)
 - Self-adjustable for bevelled doors

- Strikes**
- T-type strike, 1 $\frac{1}{8}$ x2 $\frac{3}{4}$ " (29x70 mm)
 - Wood frame security plate with 3" (76 mm) wood screws
 - Plastic dust-box

- Chassis**
- Die-cast trim ring with protective shield
 - Free-spinning solid brass cylinder collar
 - High-strength steel cylinder housing
 - Through bolt mounted
 - Exposed mounting screws

- Preparation**
- Cross bore: 2 $\frac{1}{8}$ " (54 mm)
 - Edge bore: 1" (25.4 mm)

- Cylinder**
- Solid brass, 6-pin
 - Schlage "C" keyway, 2 keys
 - Removable, rekeyable
 - Small format interchangeable core (SFIC) model – available*

Other keyways and keying options available, including CX5 high security. () Special order.*

- Functions** 51 Single cylinder, thumb-turn

- Finish** 26D–Satin chrome

Other finishes available by special order

| | | | | |
|--------|----|----------|---|--------|
| DG1 | AN | 51 | – | 26D |
| SERIES | | FUNCTION | | FINISH |

SELECTION GUIDE

| SERIES | FUNCTION ¹ | FINISH ¹ | /CASE |
|--------|--------------------------------|---------------------|-------|
| DG1 | 51 Single cylinder, thumb-turn | 26D | 12 |

(1) OTHER FINISHES AND FUNCTIONS AVAILABLE, MINIMUM ORDER QUANTITIES AND/OR ADDITIONAL DELIVERY TIMES MAY BE REQUIRED
 • KEYED FUNCTION; FULL KEYING SERVICES AVAILABLE

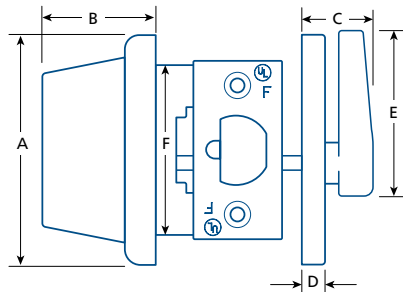

| | A | B | C | D | E | F |
|-----|---------------------------------------|--|--|-------------------------|---|-----------|
| DG1 | 2 ⁵ / ₈ (67) | 1 ⁹ / ₃₂ (32.5) | 1 ⁵ / ₁₆ (24) | 9/ ₃₂ (7) | 1 ³ / ₄ (44.5) | 2 (51) |

IN (MM)

PARTS & ACCESSORIES



DGPL238

Deadlatch: 2³/₈" (60 mm) backset,
 1¹/₈" x 2¹/₄" (28.5 x 57 mm) faceplate





- Certifications**
- Conforms to ANSI/BHMA A156.36, Grade 2
 - cULus listed, 3hr fire-rating
 - 5 Year limited warranty

- Door Thickness**
- 1 $\frac{3}{8}$ –2" (35–51 mm)

- Handing**
- Non handed

- Backset**
- 2 $\frac{3}{4}$ " (70 mm)
 - 2 $\frac{3}{8}$ " (60 mm) – available

- Spring Latch**
- Solid brass deadlatch
 - $\frac{5}{8}$ " (15.9mm) throw

- Faceplate**
- Mortise type, square corners
 - 1 $\frac{1}{8}$ x2 $\frac{1}{4}$ " (29x57 mm)
 - Self-adjustable for bevelled doors

- Strikes**
- T-type strike, 1 $\frac{1}{8}$ x2 $\frac{3}{4}$ " (29x70 mm)
 - Wood frame security plate with 3" (76 mm) wood screws
 - Plastic dust-box

- Chassis**
- Die-cast trim ring
 - Free-spinning solid brass cylinder collar
 - High-strength steel cylinder housing
 - Through bolt mounted
 - Exposed mounting screws

- Preparation**
- Cross bore: 2 $\frac{1}{8}$ " (54 mm)
 - Edge bore: 1" (25.4 mm)

- Cylinder**
- Solid brass, 6-pin
 - Schlage "C" keyway, 2 keys
 - Removable, rekeyable
 - Small format interchangeable core (SFIC) model – available*

Other keyways and keying options available, including CX5 high security. () Special order.*

- Functions** 51 Single cylinder, thumb-turn

- Finish** 26D–Satin chrome

Other finishes available by special order

| | | | | |
|--------|----|----------|---|--------|
| DG2 | AN | 51 | – | 26D |
| SERIES | | FUNCTION | | FINISH |

SELECTION GUIDE

| SERIES | FUNCTION ¹ | FINISH ¹ | /CASE |
|--------|--------------------------------|---------------------|-------|
| DG2 | 51 Single cylinder, thumb-turn | 26D | 20 |

(1) OTHER FINISHES AND FUNCTIONS AVAILABLE, MINIMUM ORDER QUANTITIES AND/OR ADDITIONAL DELIVERY TIMES MAY BE REQUIRED
 • KEYED FUNCTION; FULL KEYING SERVICES AVAILABLE

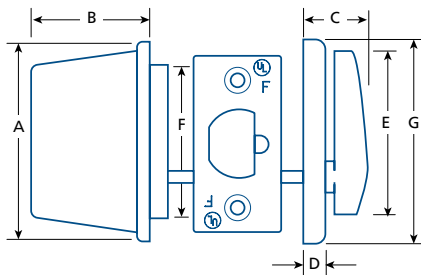

| | A | B | C | D | E | F | G |
|-----|---------------------------------------|--|--|---------------------------------------|---|-----------|---------------------------------------|
| DG2 | 2 ⁵ / ₈ (67) | 1 ⁹ / ₃₂ (32.5) | 1 ⁵ / ₁₆ (24) | 9 ³ / ₃₂ (7) | 1 ³ / ₄ (44.5) | 2 (51) | 2 ⁵ / ₈ (67) |

IN (MM)

PARTS & ACCESSORIES



DGPL238
 Deadlatch: 2³/₈" (60 mm) backset,
 1¹/₈ x 2¹/₄" (28.5 x 57 mm) faceplate





- Certifications**
- Certified ANSI/BHMA A156.13, Series 1000, Grade 1
 - cULus listed, 3hr fire-rating
 - UL10C Positive Pressure Rated
 - Levers meet ADA (ANSI 117.1) requirements
 - 5 Year limited warranty

- Door Thickness**
- 1¾" (44.5 mm)
 - 2-2¼" (51-57 mm) – available

- Handing**
- Handed, field reversible

- Backset**
- 2¾" (70 mm)

- Spring Latch**
- Brass, anti-friction
 - ¾" (19 mm) throw
 - Auxiliary deadlocking latch

- Deadbolt**
- Solid bolt, 2 security pins
 - 1" (25.4 mm) throw

- Faceplate**
- 1¼ x 8" (32x203 mm), square corners
 - Adjusts for bevelled doors up to ⅛" (3 mm)

- Strike**
- ANSI-type strike and dust-box

- Cylinder**
- 6 pin mortise cylinder
 - Schlage "C" with 2 keys
 - Small format interchangeable core (SFIC) mortise housing available (SFIC not included)
- Other keyways and keying options available, including CX5 high security*

- Sectional Trim**
- Brass lever or knob
 - Brass rose
 - S-Round: ø 2⅞ x ½" (61.5 x 12.7 mm)
 - SQ-Square: 1⅞ x 1⅞ x ½" (48 x 48 x 12.7 mm)

- Escutcheon Trim**
- Brass lever or knob
 - Brass escutcheon
 - E-Regular 2 x 8⅞ x ½" (50 x 205 x 12.7 mm)
 - E2-Wide 2½ x 8⅞ x ½" (63 x 210 x 12.7 mm)
 - E3-Large 2¾ x 10¾ x ½" (70 x 273 x 12.7 mm)

- Chassis**
- Rose trim: concealed mounting screws
 - Thumb-turn: exposed mounting screws
 - Escutcheon: exposed mounting screws
 - Single action egress

- Functions**
- | | |
|------------------------|--------------------------|
| 10 Passage | 80 Storeroom |
| 42 Privacy | 84 Storeroom w/ deadbolt |
| 42I Privacy, indicator | 170 Dummy, surface* |
| 45 Entry | 171 Dummy, thru-bolt* |
| 50 Office | 172 Dummy, back-to-back |
| 56 Dormitory | |
| 70 Classroom | |

(* Sold in pairs.)

- Lever Styles** A-Apollo, R-Circa, C-Cornell, D-Dartmouth, G-Glasgow, L-Linea, S-Stanford, F-The Flat, T-Strata

- Knob Styles** K-Kent

- Finish** 15-Satin nickel, 19-Matte black, 26D-Satin chrome
- Other finishes available by special order*

| | | | | | | |
|--------|----------|--------------------|---|------|-------|--------|
| DM | 45 | L | - | SQ | F | 26D |
| SERIES | FUNCTION | HAND ¹⁾ | | TRIM | STYLE | FINISH |

(1) L-LEFT R-RIGHT

SELECTION GUIDE

| SERIES | TRIM | STYLE** | FUNCTION ¹ | FINISH ¹ | /CASE |
|--------|------------------|---------|---|---------------------|-------|
| DM | S, SQ, E, E2, E3 | ALL | 10 Passage | 15, 19, 26D | 6 |
| DM | S, SQ, E, E2, E3 | ALL | 42 Privacy, with deadbolt | 15, 19, 26D | 6 |
| DM | E | ALL | 42I Privacy indicator, with deadbolt ² ← | 15, 19, 26D | 6 |
| DM | S, SQ, E, E2, E3 | ALL | 45 Entry, with deadbolt ← | 15, 19, 26D | 6 |
| DM | S, SQ, E, E2, E3 | ALL | 50 Office ← | 15, 19, 26D | 6 |
| DM | S, SQ, E, E2, E3 | ALL | 56 Dormitory, with deadbolt ← | 15, 19, 26D | 6 |
| DM | S, SQ, E, E2, E3 | ALL | 70 Classroom ← | 15, 19, 26D | 6 |
| DM | S, SQ, E, E2, E3 | ALL | 80* Storeroom ← | 15, 19, 26D | 6 |
| DM | S, SQ, E, E2, E3 | ALL | 84* Storeroom, with deadbolt ← | 15, 19, 26D | 6 |
| DM | S, SQ | ALL | 170 Dummy, single (surface mount) | 15, 19, 26D | 6 |
| DM | S, SQ | ALL | 171 Dummy, single (thru-bolt) | 15, 19, 26D | 6 |
| DM | S, SQ, E, E2, E3 | ALL | 172 Dummy, back-to-back | 15, 19, 26D | 6 |

(1) OTHER FINISHES AND FUNCTIONS AVAILABLE, MINIMUM ORDER QUANTITIES AND/OR ADDITIONAL DELIVERY TIMES MAY BE REQUIRED – PLEASE CONTACT

(2) FOR DETAILS ABOUT ESCUTCHEON WITH OCCUPANCY INDICATOR - PLEASE CONTACT

← KEYED FUNCTION; FULL KEYING SERVICES AVAILABLE – PLEASE CONTACT (*) ONE-SIDED INSTALLATION MODEL AVAILABLE (**) XT / INTERSECT NOT AVAILABLE WITH ESCUTCHEON

LEVERS & KNOBS

A–Apollo

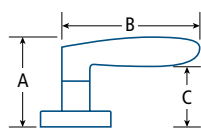

C–Cornell

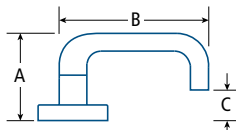

D–Dartmouth

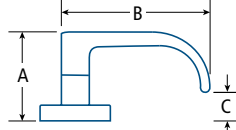

F–The Flat

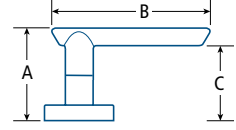

G–Glasgow

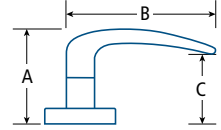

L–Linea

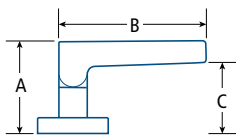

R–Circa

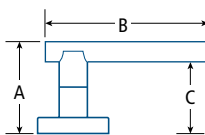

S–Stanford

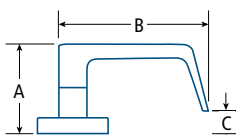

T–Strata

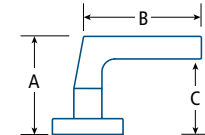

K–Kent

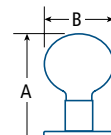

| STYLE | A | B | C ¹ |
|-------------|---------------------------------------|---------------------------------------|---------------------------------------|
| A–Apollo* | 3 ¹ / ₁₆ (78) | 4 ⁵ / ₈ (116) | 2 ¹ / ₁₆ (53) |
| C–Cornell | 2 ⁷ / ₈ (73) | 5 ⁵ / ₁₆ (134) | ⁵ / ₈ (16) |
| D–Dartmouth | 2 ⁷ / ₁₆ (61.5) | 5 ⁷ / ₈ (149) | 1 ¹ / ₁₆ (17) |
| F–The Flat | 2 ⁷ / ₈ (73) | 5 ¹ / ₂ (139.7) | 2 ³ / ₁₆ (55.5) |
| G–Glasgow | 2 ⁷ / ₈ (73) | 5 ¹ / ₁₆ (128) | 2 ¹ / ₁₆ (52) |

IN (MM) (1) ALL ROSES AND ESCUTCHEONS ARE 12.7 (1/2) THICK

| STYLE | A | B | C ¹ |
|------------|--|---------------------------------------|--|
| L–Linea | 2 ¹³ / ₁₆ (71.4) | 5 (127) | 1 ¹⁵ / ₁₆ (48.4) |
| R–Circa | 2 ⁹ / ₁₆ (65.5) | 5 ¹ / ₂ (139.7) | 1 ⁷ / ₈ (47) |
| S–Stanford | 2 ⁹ / ₁₆ (65.5) | 5 ¹ / ₁₆ (128) | ⁹ / ₁₆ (14) |
| T–Strata | 3 ¹ / ₈ (79.4) | 5 ⁵ / ₈ (130.2) | 2 ¹ / ₈ (54) |
| K–Kent | 2 ⁷ / ₁₆ (61.5) | ∅ 2 (50.8) | — |

(*) HANDED LEVER, NOT FIELD REVERSIBLE.



LOCK TRIMS

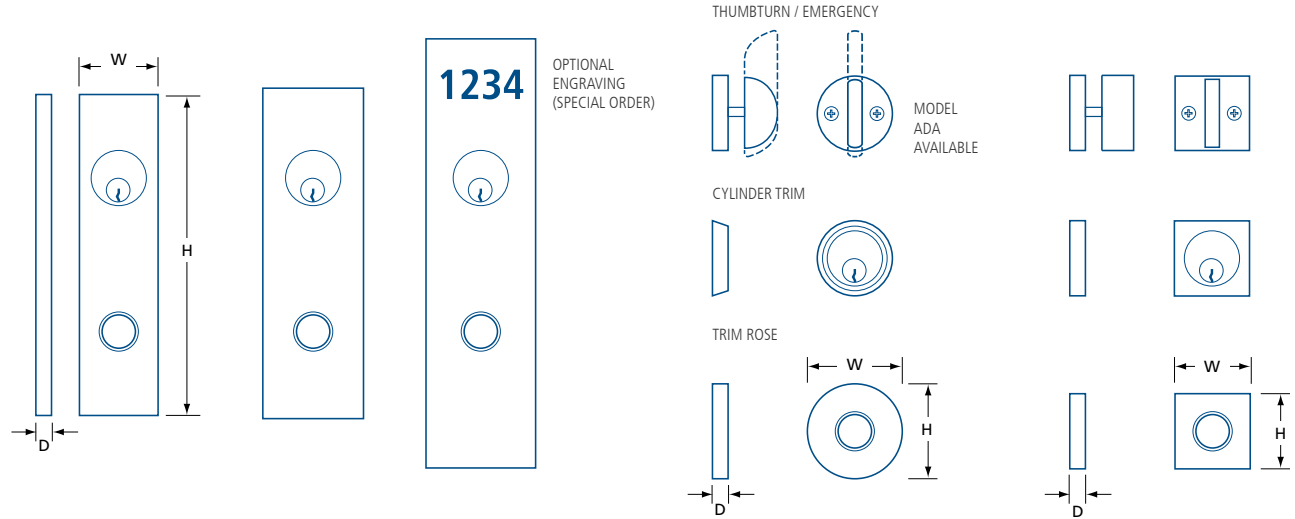

| TRIM | ESCUTCHEON TRIM | | | SECTIONAL ROUND | | | SECTIONAL SQUARE | | |
|-------------|--------------------|-----------------|------------------|-----------------|----------------|----------------|------------------|----------------|----------------|
| | E | E2 | E3 ¹ | S | | | SQ | | |
| Description | Regular escutcheon | Wide escutcheon | Large escutcheon | Round rose | Cylinder trim | Thumbturn | Square rose | Cylinder trim | Thumbturn |
| Width (W) | 2 (50) | 2 1/2 (64) | 2 3/4 (70) | ø 2 3/8 (60) | ø 1 13/16 (46) | ø 1 3/4 (44.4) | ø 1 7/8 (48) | ø 1 7/8 (47.6) | ø 1 7/8 (47.6) |
| Height (H) | 8 1/16 (205) | 8 1/4 (210) | 10 3/4 (273) | | | | | | |
| Depth (D) | 1/2 (12.7) | 1/2 (12.7) | 1/2 (12.7) | 1/2 (12.7) | 7/16 (11.1) | 3/16 (4.7) | 1/2 (12.7) | 3/8 (9.5) | 3/8 (9.5) |
| Material | Brass | Brass | Brass | Brass | Brass | Brass | Brass | Brass | Brass |

IN (MM) (1)OPTIONAL ENGRAVING AVAILABLE-PLEASE CONTACT

DIMENSIONS

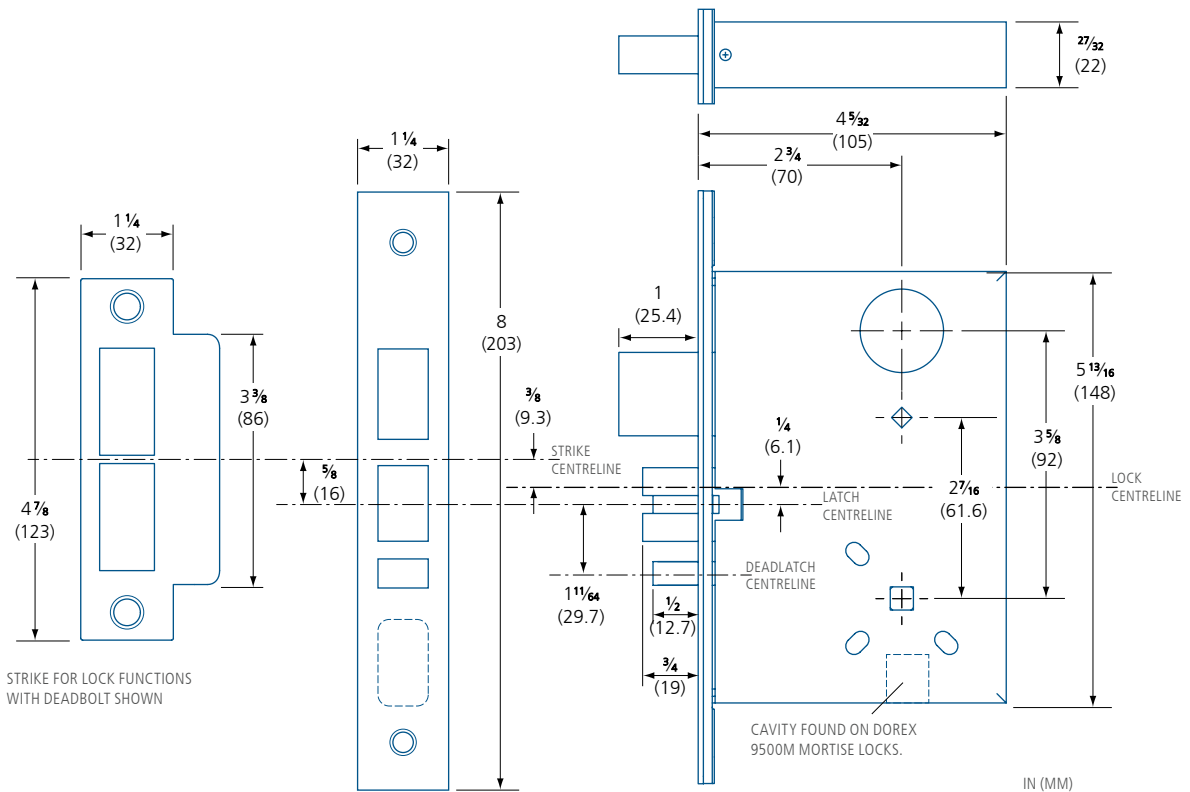

MUST BE INSTALLED ON A DOOR WITH A SOLID LOCK STILE WIDTH OF AT LEAST 5" (127 MM) OR WITH APPROPRIATE REINFORCEMENT.

⚠ WHEN USED WITH ELECTRIC STRIKE PLEASE REQUEST ADDITIONAL INFORMATION.

PARTS & ACCESSORIES



DM45X-PS
Replacement strike for 1 $\frac{3}{4}$ (45) thick door.
(Functions 42, 45, 56, 84)



DM80X-PS
Replacement strike for 1 $\frac{3}{4}$ (45) thick door.
(Functions 10, 50, 70, 80)



DM42X-PE
Mortise lock emergency privacy key; round.
Includes plate and screws.
Finish: 15, 19, 26D



DM42X-PES
Mortise lock emergency privacy key; square.
Includes plate and screws.
Finish: 15, 19, 26D



DM45X-PT
Mortise lock thumbturn; round. Mounting screws included.
Finish: 15, 19, 26D



DM45X-PTS
Mortise lock thumbturn; square. Mounting screws included.
Finish: 15, 19, 26D

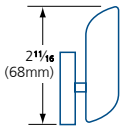

DM45X-PTA
Mortise lock ADA thumbturn; round.
Mounting screws included.
Finish: 15, 19, 26D



DM00X-PPRVI
Sectional occupancy indicator. Includes round interior/exterior trims for use with privacy (42) function. For 1 $\frac{3}{4}$ " (44.5) thick wood door. Mounting hardware included. Finish: 15, 26D



DM00X-PPRVIQ
Sectional occupancy indicator. Includes square interior/exterior trims for use with privacy (42) function. For 1 $\frac{3}{4}$ " (44.5) thick wood door. Mounting hardware included. Finish: 15, 26D



DM00X-PPRVI-ECYL
Sectional keyed occupancy indicator. Includes round interior/exterior trims for use with keyed functions 45, 56, or 84. For 1 $\frac{3}{4}$ " (44.5) thick wood door. Mounting hardware and DM00X-ECYL cylinder with 2 keys included. Finish: 15, 26D



DM00X-PPRVIQ-ECYL
Sectional keyed occupancy indicator. Includes square interior/exterior trims for use with keyed functions 45, 46, or 84. For 1 $\frac{3}{4}$ " (44.5) thick wood door. Mounting hardware and DM00X-ECYL cylinder with 2 keys included. Finish: 15, 26D



DM45X-PR
Mortise cylinder collar with spring; round.
1 $\frac{11}{16}$ x $\frac{3}{8}$ (ø43x9)
Finish: 15, 19, 26D



DM45X-PRS
Mortise cylinder collar with spring; square.
1 $\frac{7}{8}$ x 1 $\frac{7}{8}$ x $\frac{3}{8}$ (48x48x9)
Finish: 15, 19, 26D



DM00X-PSCYL

- 1 $\frac{1}{8}$ (28.6) 5-pin (drilled 6) brass mortise cylinder; Schlage "C" with 2 keys.
- For sectional installations on 1 $\frac{3}{4}$ (45) thick doors.
- Includes DM00X-PCAM.
- Finish: 15, 19, 26D

DM00X-PECYL

- 1 $\frac{1}{4}$ (31.8) 5-pin (drilled 6) brass mortise cylinder; Schlage "C" with 2 keys.
- For escutcheon installations on 1 $\frac{3}{4}$ (45) thick doors.
- Includes DM00X-PCAM.
- Finish: 15, 19, 26D

DM00X-PCAM
Replacement mortise cylinder cam, with screws

NOTE: OTHER CYLINDERS MAY REQUIRE A DIFFERENT CAM. PLEASE CONTACT IF USING A DIFFERENT CYLINDER. OTHER CAMS SOLD SEPARATELY.



DM00X-PKDT225
Installation kit for 2–2 $\frac{1}{4}$ (51–57) thick doors.

- Includes extended emergency thumbturn, spindle, springs, strike and mounting hardware for sectional or escutcheon trim.
- Mortise cylinder NOT INCLUDED. Please contact for details.





*SHOWN WITH OPTIONAL CYLINDER & COLLARS

- Certifications**
- Conforms to ANSI/BHMA A156.36, Grade 1
 - cULus listed, 3hr fire-rating
 - 5 Year limited warranty

Door Thickness • 1¼–2" (44.5–51 mm)

Handing • Non-handed

Backset • 2¾" (70 mm)

Deadbolt • Solid bolt
• 1" (25.4 mm) throw

Faceplate • 1¼ x 5⅞" (31.5 x 142 mm)
• Square corners

Strike • 1⅞ x 3½" (28.9 x 88.9 mm)
• Square corners
• Metal dust-box included

Trim • Cylinder collar and thumbturn available
• Round or square styles available

Sold separately, please contact for details

Chassis • Function 64: concealed mounting
All other functions: exposed mounting

Cylinder • Conventional and high security mortise cylinders available
• Small format interchangeable core (SFIC) mortise housing available (less core)
Sold separately, please contact for details

Functions 51 Single cylinder with thumbturn
55 Thumbturn only
60 Double cylinder
64 Cylinder only¹

(1) For use in rooms with more than one exit

Finish¹ 15–Satin nickel; 19–Matte black;
26D–Satin chrome

*Other finishes available by special order
(1) DMDBL strike and faceplate are 26D.
Trims are available in 15, 19, or 26D.*

DMDBL
SERIES

CONFIGURED TO ORDER – PLEASE CONTACT YOUR LOCAL SALES REPRESENTATIVE FOR DETAILS.

DIMENSIONS

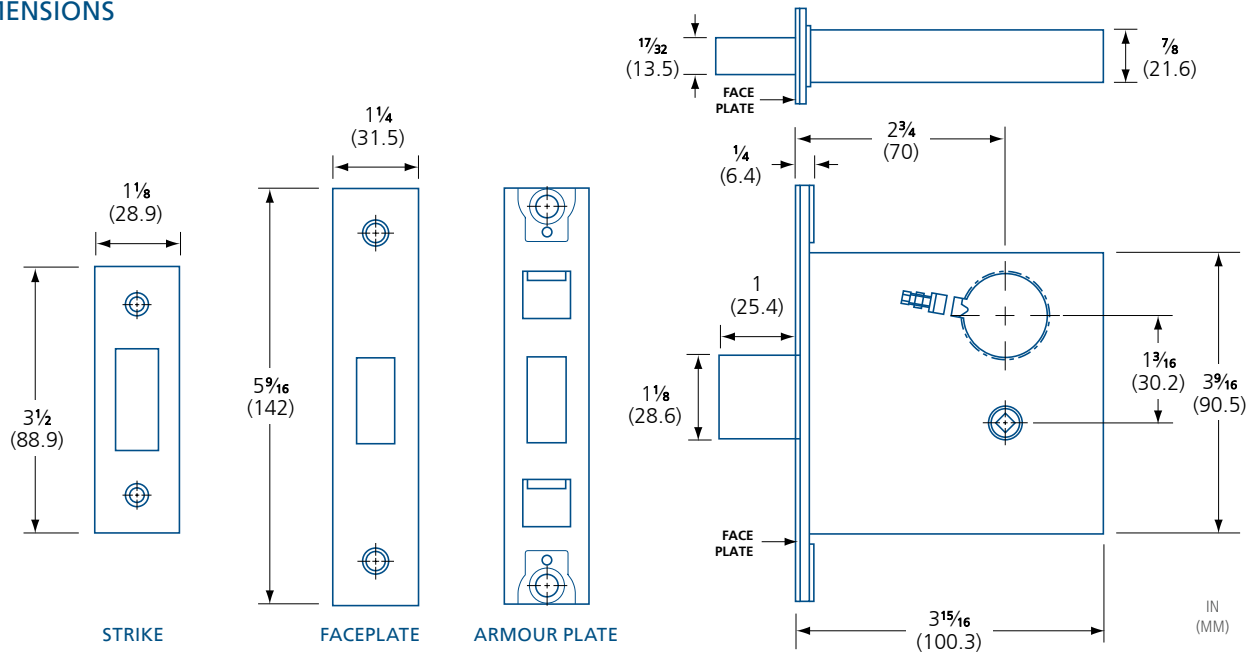

PARTS & ACCESSORIES



DM45X-PR
Mortise cylinder collar with spring; round.
Ø 1 1/16" x 3/8" (43x9 mm)
Finish: 15, 19, 26D



DM45X-PRS
Mortise cylinder collar with spring; square.
1 7/8" x 1 7/8" x 3/8" (48x48x9 mm)
Finish: 15, 19, 26D



DM00X-PSCYL

- 1 1/8" (28.6 mm) 5-pin (drilled 6) brass mortise cylinder; Schlage "C" with 2 keys.
- For installations on 1 3/4" (45 mm) thick doors.
- Includes DM00X-PCAM.
- Finish: 15, 19, 26D

DM00X-PECYL

- 1 1/4" (31.8 mm) 5-pin (drilled 6) brass mortise cylinder; Schlage "C" with 2 keys.
- For installations on 2" (51 mm) thick doors
- Includes DM00X-PCAM.
- Finish: 15, 19, 26D



DM00X-PCAM
Replacement mortise cylinder cam, with screws.

NOTE: OTHER CYLINDERS MAY REQUIRE A DIFFERENT CAM. PLEASE CONTACT IF USING A DIFFERENT CYLINDER. OTHER CAMS SOLD SEPARATELY.



DM45X-PT
Mortise lock thumbturn; round. Mounting screws included. Finish: 15, 19, 26D



DM45X-PTS
Mortise lock thumbturn; square. Mounting screws included. Finish: 15, 19, 26D



DM45X-PTA
Mortise lock ADA thumbturn; round. Mounting screws included. Finish: 15, 19, 26D

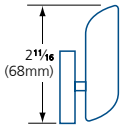

DM00X-PPRVI
Occupancy indicator. Includes round interior/ exterior trims for use with function 55. For 1 3/4" (44.5 mm) thick wood door. Mounting hardware included. Finish: 15, 26D



DM00X-PPRVIQ
Occupancy indicator. Includes square interior/ exterior trims for use with function 55. For 1 3/4" (44.5 mm) thick wood door. Mounting hardware included. Finish: 15, 26D



DM00X-PPRVI-ECYL
Keyed occupancy indicator. Includes round interior/ exterior trims for use with keyed function 51. For 1 3/4" (44.5 mm) thick wood door. Mounting hardware and DM00X-ECYL Cylinder with 2 keys included. Finish: 15, 26D



DM00X-PPRVIQ-ECYL
Keyed occupancy indicator. Includes round interior/ exterior trims for use with keyed function 51. For 1 3/4" (44.5 mm) thick wood door. Mounting hardware and DM00X-ECYL Cylinder with 2 keys included. Finish: 15, 26D



TECNICA DESIGN

D O R E X



Mortise Lock Option

All TECNICA DESIGN levers are available with the DOREX DM premium mortise lock for maximum security, 3-hour fire-rating and Grade 1 performance. Excellent for suite, office or home entry and available with a wide variety of functions, trims and escutcheon sizes.

See page 01.070 or speak with your local representative for ordering, product or specification details.



Interconnected Lock Option

The LINEA lever is available as a premium interconnected lock. The DOREX T2 IL series interconnected tubular lockset combines modern style, security and durability. Recommended as suite entry door locks in multi-unit residential applications. The T2IL offers 3 hour fire-rating and simultaneous retraction of both latch and deadbolt provides easy, panic-proof exiting.

See page 01.032 or speak with your local representative for ordering, product or specification details.



Cylindrical Lock Option

TECNICA DESIGN's The Flat lever is available as a Grade 2 quality, 3hr fire-rated, commercial cylindrical lock. Ideal for multi-unit buildings requiring a stylish lever that offers common commercial functions, and can handle the wear and tear of frequent use.

See page 01.021 or speak with your local representative for ordering, product or specification details.



Levers

- Modern lever styles ideal for contemporary styled homes and residential applications
- Privacy function with auto-release
- Concealed mounting screws
- Available with square or round rose
- All lever styles available with magnetic latches and strikes for seamless, minimalist installations



- Conforms to ANSI/BHMA Grade 3
- Meets ADA requirements
- 20 Minute fire-rating when installed with optional listed fire can*
- Lifetime mechanical warranty
- 10-year limited finish warranty

- Non-handed, zinc die-cast levers
- For doors 1 $\frac{3}{8}$ –1 $\frac{3}{4}$ " (35–44.5 mm) thick
- Extension kit for 2 $\frac{1}{4}$ " (57 mm) thick doors available (#TDK100TE)
- Fits standard 2 $\frac{1}{8}$ " (54 mm) door preparation with 1" (25.4 mm) edge bore
- Stainless steel tubular spring latch with adjustable 2 $\frac{3}{8}$ –2 $\frac{3}{4}$ " (60–70 mm) backset
- Mortised faceplate with square corners, convertible to drive-in
- Galvanized steel interior mechanism
- Full-lip strike with round corners included.
- Concealed mounting screws

(*) Firecan kit must be ordered in conjunction with lockset, not available separately. For use on fire labelled, wood doors only.

- Available with magnetic tubular latch and invisible strike
- ASA strike for metal door frames available
- Other faceplate options available

AVAILABLE FUNCTIONS

- 10 Passage
- 42 Privacy, with auto-release
- 5 Dummy, single (surface / thru-bolt)¹
- 3 Handleset interior trim²

(1) Can be installed back-to-back using thru-bolts
(2) For use with Tecnica Design entry handlesets



LINEA – ROUND
SATIN NICKEL



© DOREX



THE FLAT – SQUARE
SATIN NICKEL



NEW



STRATA – SQUARE
SATIN NICKEL



CIRCA
SATIN NICKEL



SELECTION GUIDE

| | | | | | | |
|--------|-----------------------|-------|-------------------|--------|--------------------|---------------------|
| 100 | 10 | FT | S | 15 | M | — |
| SERIES | FUNCTION ¹ | STYLE | ROSE ² | FINISH | LATCH ³ | OPTION ⁴ |

(1) OMIT FUNCTION WHEN ORDERING DUMMY OR HANDLESET TRIM OPTION (2) BLANK : ROUND
 S: SQUARE (3) M: MORTISE V: DRIVE-IN (4) -3: HANDLE TRIM -5: DUMMY



Firecan kit must be ordered in conjunction with lock, not available separately. For fire labelled wood doors ONLY.

| | | 10B OIL RUB. BRONZE | 11P ANTIQU BRONZE | 15 SATIN NICKEL | 15A ANTIQU NICKEL | 19 MATTE BLACK | 26 POLISHED CHROME | 26D SATIN CHROME | 3 POLISHED BRASS | 32D SATIN S.STEEL | 4 SATIN BRASS | 5 ANTIQU BRASS | V3* POLISHED BRASS | /CASE† |
|----------|----|---------------------------|-------------------------|-----------------------|-------------------------|----------------------|--------------------------|------------------------|------------------------|-------------------------|---------------------|----------------------|--------------------------|--------|
| CIRCA | CT | | | • | | • | • | • | | | | | | 10 |
| LINEA | LT | | | • | | • | • | • | | | | | | 10 |
| THE FLAT | FT | | | • | | • | • | • | | | | | | 10 |
| STRATA | ST | | | • | | • | • | • | | | | | | 10 |

OTHER FINISHES AVAILABLE, MINIMUM ORDER QUANTITIES AND/OR ADDITIONAL DELIVERY TIMES MAY BE REQUIRED – PLEASE CONTACT (*) LIFETIME FINISH WARRANTY (†) DUMMY ARE 20/CASE

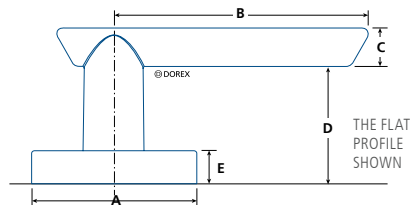

| | A | B | C | D | E |
|----------------------|--|---|--|---|---------------|
| CIRCA CT | 2 ⁹ / ₁₆ (64.5) | 4 (101.6) | 1 ⁹ / ₃₂ (15) | 1 ³ / ₄ (45) | 1/2 (12.7) |
| LINEA LT / LTS | 2 ⁹ / ₁₆ (64.5) | 4 (101.6) | 2 ⁵ / ₃₂ (20) | 1 ⁹ / ₁₆ (40) | 1/2 (12.7) |
| THE FLAT FT / FTS | 2 ⁹ / ₁₆ (64.5) | 4 (101.6) | 3 ⁷ / ₆₄ (14.7) | 1 ²⁵ / ₃₂ (45.3) | 1/2 (12.7) |
| STRATA ST / STS | 2 ⁹ / ₁₆ (64.5) | 4 ⁹ / ₁₆ (115.9) | 7/8 (22) | 1 ⁵ / ₈ (42) | 1/2 (12.7) |

IN (MM)

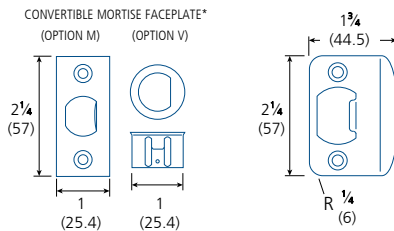

(*) Regardless of option ordered, the part required to convert from one option to the other is included.

Magnetic Latch Option



All TECNICA DESIGN levers are available with magnetic latches and strikes providing the perfect solution for ultra-quiet applications. With no protruding bolt or strike lip, these latches offer a clean, minimalist look for those looking to create unique, flush-to-wall, and snag-free installations free of unsightly latch bolts or strike lips.



Not fire rated.

- Strike and latch use strong neodymium (rare earth) magnets
- Ergonomic 30-degree activation
- Requires the same tools and preparation as classic tubular latches
- Pair with invisible hinges for unique flush-to-wall door installations
- Not for use in fire-rated applications
- Only available for Passage or Privacy (with auto-release) functions

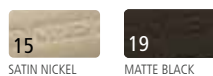

| | | | | | | |
|----------------------|--------|----------|-------|-------------------|--------|-------|
| M6 | 100 | 10 | FT | S | 15 | M |
| BACKSET ¹ | SERIES | FUNCTION | STYLE | ROSE ² | FINISH | LATCH |

(1) M6: 2³/₄IN (60MM) FIXED BACKSET, M7: 2³/₄IN (70MM) FIXED BACKSET
 (2) 10: PASSAGE, 42: PRIVACY (3) BLANK : ROUND, S: SQUARE



Entry Handlesets

- Reliable, quality modern entry handlesets for residential homes
- Concealed mounting screws
- Includes Linea interior lever and matching round or square thumbturn
- Interior lever can be swapped with any other Tecnica Design lever¹

(1) Availability may vary, please contact your local Dorex representative.

- Conforms to ANSI/BHMA Grade 3
- 25-year mechanical warranty
- 5-year limited finish warranty
- Non-handed, zinc die-cast exterior trim
- For doors 1¾–2¼" (44.5–57 mm) thick
- Fits standard 2⅝" (54 mm) door preparation with 1" (25.4 mm) edge bore
- Steel tubular spring latch with adjustable 2⅞–2¾" (60–70 mm) backset.
- Steel 1" (25.4 mm) deadbolt latch with hardened steel security pin and adjustable 2⅞–2¾" (60–70 mm) backset
- Mortised faceplate with square corners, convertible to drive-in
- Galvanized steel interior mechanism
- Weiser 5-pin brass cylinder in steel housing with 2 keys
- Full-lip strike and deadbolt strike for wood door frames included

AVAILABLE FUNCTIONS

T401 Entry
(single cylinder w/ thumbturn)

G3

25
YEAR

SELECTION GUIDE

| T401 | PT | LTS | 15 | KD | W |
|--------|--------------------|-------------------|--------|--------|-------|
| SERIES | STYLE ¹ | TRIM ² | FINISH | KEYING | LATCH |

(1) AR: ARCO; DT: DELTA; PT: PLATO (2) LTS: LINEA-SQUARE

| | 10B OIL RUB. BRONZE | 11P ANTIQU BRONZE | 15 SATIN NICKEL | 15A ANTIQU NICKEL | 19 MATTE BLACK | 26 POLISHED CHROME | 26D SATIN CHROME | 3 POLISHED BRASS | 32D SATIN S.STEEL | 4 SATIN BRASS | C5 ANTIQU BRASS | V3* POLISHED BRASS | /CASE |
|--------------|---------------------------|-------------------------|-----------------------|-------------------------|----------------------|--------------------------|------------------------|------------------------|-------------------------|---------------------|-----------------------|--------------------------|-------|
| ARCO | AR | | • | | • | • | • | | | | | | 6 |
| DELTA | DT | | • | | • | • | • | | | | | | 6 |
| PLATO | PT | | • | | • | • | • | | | | | | 6 |

OTHER FINISHES AVAILABLE, MINIMUM ORDER QUANTITIES AND/OR ADDITIONAL DELIVERY TIMES MAY BE REQUIRED – PLEASE CONTACT (*) LIFETIME FINISH WARRANTY

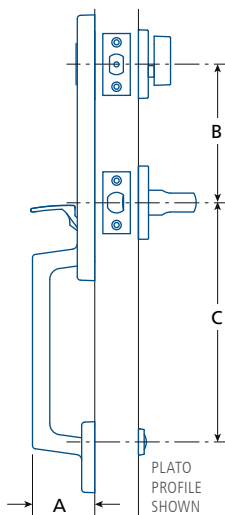

| | A | B | C |
|--------------|---------------------------------|-------------------------------|---|
| ARCO | 2 ¹¹ / ₁₆ | 5 ¹ | 8 ³ / ₄ – 10 ³ / ₈ ² |
| AR | (68) | (127) | (222 – 264) |
| DELTA | 2 ¹ / ₈ | 5 ¹ | 8 ¹³ / ₃₂ |
| DT | (54) | (127) | (214) |
| PLATO | 2 ¹¹ / ₁₆ | 5 ¹ / ₂ | 8 ³ / ₄ – 10 ³ / ₈ ² |
| PT | (68) | (140) | (222 – 264) |

IN (MM) (1) RECOMMENDED DISTANCE (2) ADJUSTABLE

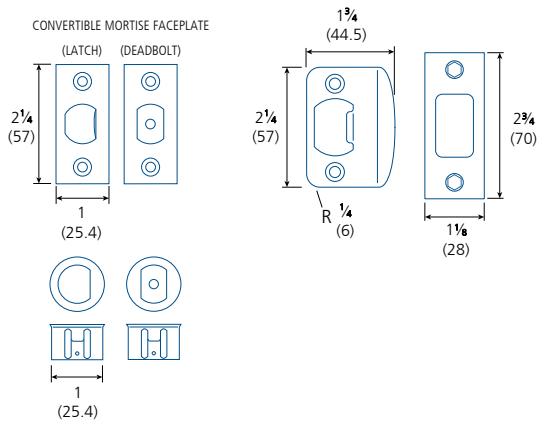

Deadbolt Locks

- TECNICA DESIGN deadbolts are a blend of aesthetics, security, and dependability
- ANSI/BHMA Grade 3 Security, excellent for suite entry doors and offices
- Concealed mounting screws
- Can be keyed to insert into any key system.
- Can accommodate CX5 High Security cylinders for enhanced security



GIRO
SATIN NICKEL



- Certified ANSI/BHMA Grade 3.
- 20 Minute fire-rating when installed with optional listed fire can*
- 25-year mechanical warranty
- 5-year limited finish warranty.

- For doors 1 $\frac{3}{8}$ –1 $\frac{3}{4}$ " (35–44.5 mm) thick
- Extension kit for 2 $\frac{1}{4}$ " (57 mm) thick doors available (#TLA85052)
- Fits standard 2 $\frac{1}{8}$ " (54 mm) door preparation with 1" (25.4 mm) edge bore
- Steel 1" (25.4 mm) deadbolt latch with hardened steel security pin and adjustable 2 $\frac{3}{8}$ –2 $\frac{3}{4}$ " (60–70 mm) backset
- Mortised faceplate with square corners, convertible to drive-in
- Galvanized steel interior mechanism.
- Removable brass cylinder in steel housing with 2 keys
- Security strikes for wood and metal door frames included

(* *Firecan kit must be ordered in conjunction with lock, not available separately. For use on fire labelled, wood doors only.*

- Keying options available – including CX5 high security cylinders
- Other faceplate options available



QUADRA
SATIN NICKEL



AVAILABLE FUNCTIONS

- 51 Single cylinder with thumbturn



SELECTION GUIDE

| | | | | | |
|---|----------|-------|--------|---------------------|--------------------|
| 201 | 51 | TR | 15 | KD | M |
| SERIES ¹ | FUNCTION | STYLE | FINISH | KEYING ² | LATCH ³ |
| (1) 201: WEISER 5-PIN 202: SCHLAGE 6-PIN KEYWAY (2) KA: KEYED ALIKE KD: KEYED DIFFERENT | | | | | |
| (3) M: MORTISE V: DRIVE-IN ONLY | | | | | |



Firecan kit must be ordered in conjunction with deadbolt, not available separately. For fire labelled wood doors ONLY.

Full keying services available – please contact for details

| STYLE | 10B OIL RUB. BRONZE | 11P ANTIQUE BRONZE | 15 SATIN NICKEL | 15A ANTIQUE NICKEL | 19 MATTE BLACK | 26 POLISHED CHROME | 26D SATIN CHROME | 32D SATIN S.STEEL | 3 POLISHED BRASS | 4 SATIN BRASS | 5 ANTIQUE BRASS | V3* POLISHED BRASS | /CASE |
|---------------|---------------------------|--------------------------|-----------------------|--------------------------|----------------------|--------------------------|------------------------|-------------------------|------------------------|---------------------|-----------------------|--------------------------|-------|
| GIRO | TR | | • | | • | • | • | | | | | | 24 |
| QUADRA | TS | | • | | • | • | • | | | | | | 24 |

OTHER FINISHES AVAILABLE, MINIMUM ORDER QUANTITIES AND/OR ADDITIONAL DELIVERY TIMES MAY BE REQUIRED – PLEASE CONTACT (*) LIFETIME FINISH WARRANTY

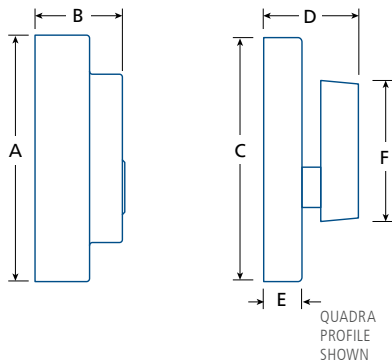

| | A | B | C | D | E | F |
|---------------|----------|--------|--------|--------|-----|------|
| GIRO | 2½ | 15/16 | 2½ | 1 | 3/8 | 17/8 |
| TR | ∅ (64) | (23.8) | (64) | (25.4) | (9) | (47) |
| QUADRA | 29/16 | 15/16 | 29/16 | 1 | 3/8 | 1¾ |
| TS | ∅ (64.5) | (23.8) | (64.5) | (25.4) | (9) | (45) |

IN (MM)

CONVERTIBLE MORTISE FACEPLATE*
(OPTION M) (OPTION V)

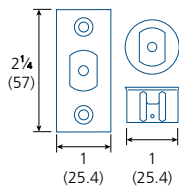

SECURITY STRIKES
(WOOD / METAL)

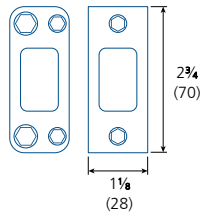

(*) Regardless of option ordered, the part required to convert from one option to the other is included.

PARTS & ACCESSORIES



200T-SWA
Replacement thumbturn setscrew, spring washer, and hex key.





MAGNETIC LATCHES

Tecnica Design magnetic latches provide the perfect solution for ultra-quiet residential applications. With no protruding bolt or strike lip, these latches offer a clean, minimalist look to homeowners looking to create unique flush-to-wall installations free of unsightly strikes or bolts.

Magnetic Latches

All TECNICA DESIGN levers are available with magnetic latches and strikes providing the perfect solution for ultra-quiet applications. With no protruding bolt or strike lip, these latches offer a clean, minimalist look for those looking to create unique, flush-to-wall, and snag-free installations free of unsightly latch bolts or strike lips.

- Strike and latch use strong neodymium (rare earth) magnets.
- Ergonomic 30-degree activation.
- Requires the same tools and door preparation as classic tubular latches.
- Pair with invisible hinges for unique flush-to-wall door installations.
- Not for use in fire-rated applications. Cannot be used with a DOREX firecan kit.
- Only available for Passage or Privacy (with auto-release) functions.



HOW DOREX MAGNETIC LATCHES WORK

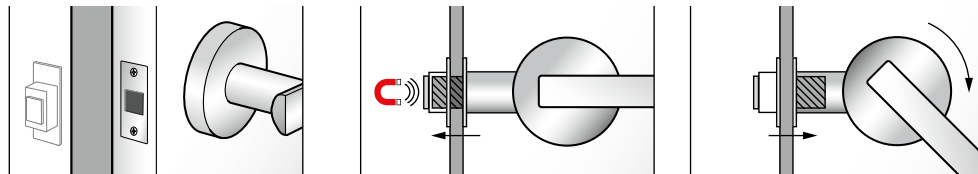

WHEN OPEN, the latch is held retracted while the door is open for a clean, minimalist look. Since the strike has no lip, it is not visible.

WHEN CLOSING, a rare-earth magnet will instantly and quietly pull the latch into the strike to latch the door securely.

WHEN USING the lever, the latch will quietly retract and be held magnetically. Even when the lever is released, the latch will remain retracted in its housing.

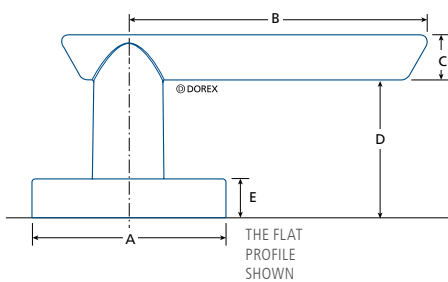

| | A | B | C | D | E |
|-----------------------------|--|---|--|---|---------------|
| CIRCA CT | ∅ 2 ⁹ / ₁₆ (64.5) | 4 (101.6) | 1 ⁹ / ₃₂ (15) | 1 ³ / ₄ (45) | 1/2 (12.7) |
| LINEA LT / LTS | ∅ 2 ⁹ / ₁₆ (64.5) | 4 (101.6) | 2 ⁵ / ₃₂ (20) | 1 ⁹ / ₁₆ (40) | 1/2 (12.7) |
| THE FLAT FT / FTS | ∅ 2 ⁹ / ₁₆ (64.5) | 4 (101.6) | 3 ⁷ / ₆₄ (14.7) | 1 ²⁵ / ₃₂ (45.3) | 1/2 (12.7) |
| STRATA ST / STS | 2 ⁹ / ₁₆ (64.5) | 4 ⁹ / ₁₆ (115.9) | 7/8 (22) | 1 ⁵ / ₈ (42) | 1/2 (12.7) |

IN (MM)

SELECTION GUIDE

| | 10B OIL RUB. BRONZE | 11P ANTIQUE BRONZE | 15 SATIN NICKEL | 15A ANTIQUE NICKEL | 19 MATTE BLACK | 26 POLISHED CHROME | 26D SATIN CHROME | 3 POLISHED BRASS | 32D SATIN S.STEEL | 4 SATIN BRASS | 5 ANTIQUE BRASS | V3* POLISHED BRASS | /CASE |
|-----------------|---------------------------|--------------------------|-----------------------|--------------------------|----------------------|--------------------------|------------------------|------------------------|-------------------------|---------------------|-----------------------|--------------------------|-------|
| CIRCA | CT | | • | | • | | | | | | | | 10 |
| LINEA | LT | | • | | • | | | | | | | | 10 |
| THE FLAT | FT | | • | | • | | | | | | | | 10 |
| STRATA | ST | | • | | • | | | | | | | | 10 |

OTHER FINISHES AVAILABLE, MINIMUM ORDER QUANTITIES AND/OR ADDITIONAL DELIVERY TIMES MAY BE REQUIRED – PLEASE CONTACT (*) LIFETIME FINISH WARRANTY

| M6 | 100 | 10 | FT | S | 15 | M |
|----------------------|--------|-----------------------|-------|-------------------|--------|-------|
| BACKSET ¹ | SERIES | FUNCTION ² | STYLE | ROSE ³ | FINISH | LATCH |

(1) M6: 2³/₁₆IN (60MM) FIXED BACKSET, M7: 2³/₁₆IN (70MM) FIXED BACKSET
 (2) 10: PASSAGE, 42: PRIVACY (3) BLANK : ROUND, S: SQUARE

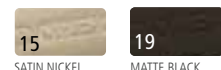

DOREX®

Signature





Levers

- Classic, modern lever styles that can fit into any decor
- Non-handed and handed lever styles
- Privacy function with auto-release
- Keyed entry function available
- Can be keyed to insert into any key system



- Conforms to ANSI/BHMA Grade 3
- 20 Minute fire-rating when installed with optional listed fire can*
- 25 year mechanical warranty
- 5 year limited finish warranty
- Non-handed or handed, zinc die-cast lever
- For doors 1 $\frac{3}{8}$ –1 $\frac{3}{4}$ " (35–44.5 mm) thick
- Fits standard 2 $\frac{1}{8}$ " (54 mm) door preparation with 1" (25.4 mm) edge bore
- Stainless steel tubular spring latch with adjustable 2 $\frac{3}{8}$ –2 $\frac{3}{4}$ " (60–70 mm) backset
- Mortise faceplate with square corners, convertible to drive-in
- Galvanized steel interior mechanism
- Entry models include removable 5-pin cylinder with 2 keys
- Full-lip strike with round corners included

(* Firecan kit must be ordered in conjunction with lockset, not available separately. For use on fire labelled, solid wood doors only.

- Keying options available
- Other faceplate options available
- 5" (127 mm) backset latch available

AVAILABLE FUNCTIONS

- 10 Passage
- 42 Privacy, with auto-release
- 51 Entry ↔
- 1 Single Dummy (surface)
- 2 Single Dummy (thru-bolt)
- 3 Handleset trim*

(* Handleset trim includes lever spring latch)



SELECTION GUIDE

| 101 | 51 | AT | C15 | KD | M | RH | — |
|---|----------|-------|--------|--------|--------------------|-------------------|---------------------|
| SERIES ¹ | FUNCTION | STYLE | FINISH | KEYING | LATCH ² | HAND ³ | OPTION ⁴ |
| (1) 100: NO KEYWAY; 101: WEISER; 102: SCHLAGE KEYWAY; OMIT FUNCTION AND USE 100 WHEN ORDERING DUMMY OR TRIM (2) M: MORTISE W: DRIVE-IN (3) ATHENA OR DUMMY APOLLO, INDICATE RH: RIGHT HAND, LH: LEFT HAND (4) -1: DUMMY, SINGLE -2: DUMMY, THRU-BOLT -3: TRIM | | | | | | | |



Firecan kit must be ordered in conjunction with lock, not available separately. For fire labelled wood doors ONLY.

Full keying services available – please contact for details.

| | C10B OIL RUB. BRONZE | C11P ANTIQUÉ BRONZE | C15 SATIN NICKEL | C15A ANTIQUÉ NICKEL | C19 MATTE BLACK | C26D SATIN CHROME | C3 POLISHED BRASS | C32D SATIN S.STEEL | C4 SATIN BRASS | C5 ANTIQUÉ BRASS | V3** POLISHED BRASS | /CASE† |
|-----------------------------|----------------------------|---------------------------|------------------------|---------------------------|-----------------------|-------------------------|-------------------------|--------------------------|----------------------|------------------------|---------------------------|--------|
| ATHENA (REVERSIBLE)* | AT | ● | ● | ● | ● | ● | | | | | | 20 |
| APOLLO (REVERSIBLE)* | AP | ● | ● | | | ● | | | | | | 20 |
| CAMBRIDGE | CB | ● | ● | ● | | ● | | | | | | 20 |
| ESCORT | ES | | | | | ● | ● | | | | | 20 |
| HAWTHORNE | HW | | | | | ● | | | | | | 20 |
| JUNO | JN | | ● | | ● | ● | | | | | | 20 |
| MANHATTAN | M | | | ● | | ● | ● | ● | | | | 20 |

OTHER FINISHES AVAILABLE, MINIMUM ORDER QUANTITIES AND/OR ADDITIONAL DELIVERY TIMES MAY BE REQUIRED – PLEASE CONTACT (*) RIGHT HAND, FIELD REVERSIBLE. DUMMY LEVERS ARE NOT REVERSIBLE, PLEASE INDICATE HANDING. (**) LIFETIME FINISH WARRANTY (†) DUMMY ARE 20/CASE

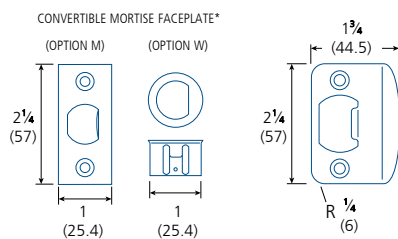
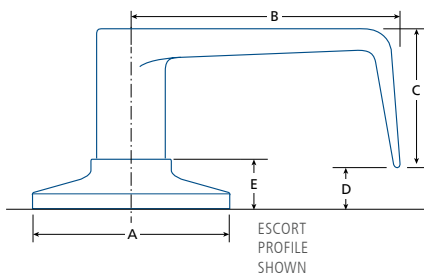

(*) Regardless of option ordered, the part required to convert from one option to the other is included.

| | A | B | C | D | E |
|------------------|--------|---------|--------|---------|--------|
| ATHENA | 2 9/16 | 3 15/16 | 1 | 1 9/16 | 1 9/32 |
| AT | (65) | (100) | (25) | (40) | (15) |
| APOLLO | 2 9/16 | 4 1/8 | 3/4 | 1 3/8 | 1 9/32 |
| AP | (65) | (105) | (20) | (35) | (15) |
| CAMBRIDGE | 2 9/16 | 3 15/16 | 5/16 | 1 31/32 | 1 9/32 |
| CB | (65) | (100) | (8) | (50) | (15) |
| ESCORT | 2 9/16 | 3 15/16 | 1 1/2 | 1 5/32 | 1 9/32 |
| ES | (65) | (100) | (38) | (12) | (15) |
| HAWTHORNE | 2 9/16 | 3 15/16 | 3/8 | 1 31/32 | 1 9/32 |
| HW | (65) | (100) | (9.5) | (50) | (15) |
| JUNO | 2 9/16 | 4 1/8 | 1 1/16 | 1 9/16 | 1 9/32 |
| JN | (65) | (105) | (18) | (40) | (15) |
| MANHATTAN | 2 9/16 | 3 15/32 | 5/16 | 1 31/32 | 1 9/32 |
| M | (65) | (88) | (8) | (50) | (15) |

IN (MM)



Knobs

- Classic, knob styles that can fit into any decor
- Privacy function with auto-release
- Keyed entry function available
- Can be keyed to insert into any key system



BALA
SATIN NICKEL

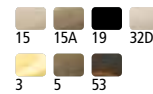

- Conforms to ANSI/BHMA Grade 3
- 20 Minute fire-rating when installed with optional listed firecan kit*
- 25 year mechanical warranty
- 5 year limited finish warranty

- Steel knob and rose
- For doors 1 $\frac{3}{8}$ –1 $\frac{3}{4}$ " (35–44.5 mm) thick
- Fits standard 2 $\frac{1}{8}$ " (54 mm) door preparation with 1" (25.4 mm) edge bore
- Stainless steel spring latch with adjustable backset
- Mortise faceplate with square corners, convertible to drive-in
- Galvanized steel interior mechanism
- Entry models include removable 5-pin cylinder with 2 keys
- Full-lip strike with round corners included

(*) Firecan kit must be ordered in conjunction with lockset, not available separately. For use on fire labelled, solid wood doors only.

- Keying options available
- Other faceplate options available
- 5" (127 mm) backset latch available



EGLINGTON
ANTIQUÉ NICKEL



AVAILABLE FUNCTIONS

- 10 Passage
- 42 Privacy, with auto-release
- 51 Entry ↔
- 1 Single Dummy (surface)
- 2 Single Dummy (thru-bolt)
- 3 Handleset trim



SELECTION GUIDE

| 101 | 51 | B | C15 | KD | M | - |
|---|----------|-------|--------|--------|--------------------|---------------------|
| SERIES ¹ | FUNCTION | STYLE | FINISH | KEYING | LATCH ² | OPTION ³ |
| (1) 100: NO KEYPWAY 101: WEISER 102: SCHLAGE KEYWAY; OMIT FUNCTION AND USE 100 WHEN ORDERING DUMMY OR TRIM (2) M: MORTISE W: DRIVE-IN (3) -1: DUMMY, SINGLE -2: DUMMY, THRU-BOLT -3: TRIM | | | | | | |



Firecan kit must be ordered in conjunction with lock, not available separately. For fire labelled wood doors ONLY.

Full keying services available – please contact for details

| | | C10B | C11P | C15 | C15A | C19 | C26 | C26D | C3 | C32D | C4 | C5 | 53 | /CASE |
|------------------|----|-----------------|---------------|--------------|---------------|-------------|-----------------|--------------|----------------|---------------|-------------|--------------|-------------------|-------|
| | | OIL RUB. BRONZE | ANTIQU BRONZE | SATIN NICKEL | ANTIQU NICKEL | MATTE BLACK | POLISHED CHROME | SATIN CHROME | POLISHED BRASS | SATIN S.STEEL | SATIN BRASS | ANTIQU BRASS | ANT. / POL. BRASS | |
| BALA | B | | | • | • | • | | | • | • | | • | • | 20 |
| EGLINGTON | EG | | | • | • | • | | • | | | | | | 20 |

OTHER FINISHES AVAILABLE, MINIMUM ORDER QUANTITIES AND/OR ADDITIONAL DELIVERY TIMES MAY BE REQUIRED – PLEASE CONTACT

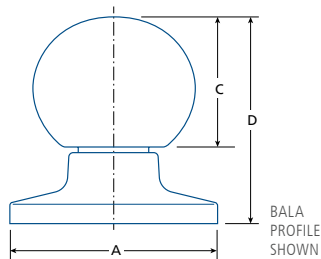

| | A | B | C | D |
|------------------|--------------------------------|-------------------------------|--------------------------------|-------------------------------|
| BALA | 2 ⁹ / ₁₆ | 2 | 1 ¹ / ₁₆ | 2 ¹ / ₂ |
| B | (65) | (51) | (40) | (63.5) |
| EGLINGTON | 2 ⁹ / ₁₆ | 1 ³ / ₈ | 1 ¹ / ₁₆ | 2 ¹ / ₂ |
| EG | (65) | (60) | (40) | (63.5) |

IN (MM)

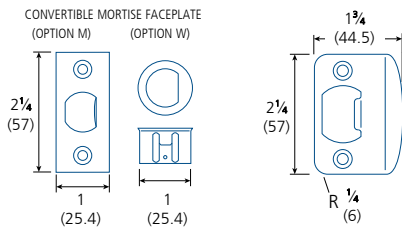

(* Regardless of option ordered, the part required to convert from one option to the other is included.



Entry Handlesets

- Reliable, quality classic entry handlesets for residential homes
- Non-handed
- Includes Bala interior knob
- Interior knob can be swapped with any other Signature lever or knob¹
- Can be keyed to insert into any key system
- Can accommodate CX5 High Security cylinders for enhanced security

(1) Availability may vary, please contact your local Dorex representative.

- Conforms to ANSI/BHMA Grade 3
- 20 Minute fire-rating when installed with optional listed firecan kits*
- 25 year mechanical warranty
- 5 year limited finish warranty
- Non-handed, zinc die-cast exterior trim
- For doors 1 $\frac{3}{8}$ –2 $\frac{1}{4}$ " (44.5–57 mm) thick
- Fits standard 2 $\frac{1}{8}$ " (54 mm) door preparation with 1" (25.4 mm) edge bore
- Stainless steel tubular spring latch with adjustable 2 $\frac{3}{8}$ –2 $\frac{3}{4}$ " (60–70 mm) backset
- Brass 1" (25.4 mm) deadbolt latch with hardened steel security pin and adjustable 2 $\frac{3}{8}$ –2 $\frac{3}{4}$ " (60–70 mm) backset
- 4-way mortise faceplate with square corners, convertible to drive-in
- Galvanized steel interior mechanism
- Removable 5-pin brass cylinder in steel housing with 2 keys
- Full-lip strike and security strike for wood door frames (round corners) included

(*) Firecan kits must be ordered in conjunction with handleset, not available separately. For use on fire labelled, solid wood doors only.

AVAILABLE FUNCTIONS

- Entry ↔
- Dummy – available



CAPRI
SATIN NICKEL
11P 15 15A 19



MAYFAIR
MATTE BLACK
11P 15 15A 19
26 26D 3 5



IMPERIAL
ANTIQUÉ NICKEL
11P 15 15A



BIARRITZ
ANTIQUÉ BRASS
15A 5

SELECTION GUIDE

| 401 | BI | B | C15 | KD | W | - |
|--|-------|------|--------|--------|-------|---------------------|
| SERIES ¹ | STYLE | TRIM | FINISH | KEYING | LATCH | OPTION ² |
| (1) 400: NO KEYWAY 401: WEISER 402: SCHLAGE KEYWAY USE 400 WHEN ORDERING DUMMY | | | | | | |
| (2) DUM: DUMMY | | | | | | |



Fire-cans (2) must be ordered in conjunction with lock, not available separately. For fire labelled wood doors ONLY.

GATE LATCH AVAILABLE, must be ordered in conjunction with handleset – please contact for details.

Full keying services available – please contact for details

| | C10B OIL RUB. BRONZE | C11P ANTIQUÉ BRONZE | C15 SATIN NICKEL | C15A ANTIQUÉ NICKEL | C19 MATTE BLACK | C26 POLISHED CHROME | C26D SATIN CHROME | C3 POLISHED BRASS | C32D SATIN S.STEEL | C4 SATIN BRASS | C5 ANTIQUÉ BRASS | V3* POLISHED BRASS | /CASE |
|----------|----------------------------|---------------------------|------------------------|---------------------------|-----------------------|---------------------------|-------------------------|-------------------------|--------------------------|----------------------|------------------------|--------------------------|-------|
| BIARRITZ | BI | | | • | | | | | | | • | • | 6 |
| CAPRI | CA | • | • | • | • | | | | | | | | 6 |
| IMPERIAL | IM | • | • | • | | | | | | | | | 6 |
| MAYFAIR | MA | • | • | • | • | • | • | • | | | • | • | 6 |

OTHER FINISHES AVAILABLE, MINIMUM ORDER QUANTITIES AND/OR ADDITIONAL DELIVERY TIMES MAY BE REQUIRED – PLEASE CONTACT (*) LIFETIME FINISH WARRANTY

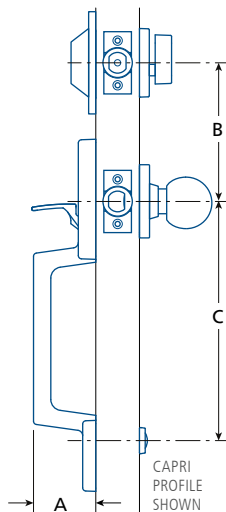

| | A | B* | C |
|----------------|--|------------|--|
| BIARRITZ BI | 2 ³ / ₈ (60) | 5 (127) | 8 ¹³ / ₃₂ (214) |
| CAPRI CA | 2 ⁵ / ₃₂ (55) | 5 (127) | 8 ¹³ / ₃₂ (214) |
| IMPERIAL IM | 2 ⁹ / ₁₆ (65) | 5 (127) | 8 ¹³ / ₃₂ (214) |
| MAYFAIR MA | 2 ⁷ / ₁₆ (62) | 5 (127) | 8 ¹³ / ₃₂ (214) |

IN (MM) (*) RECOMMENDED DISTANCE

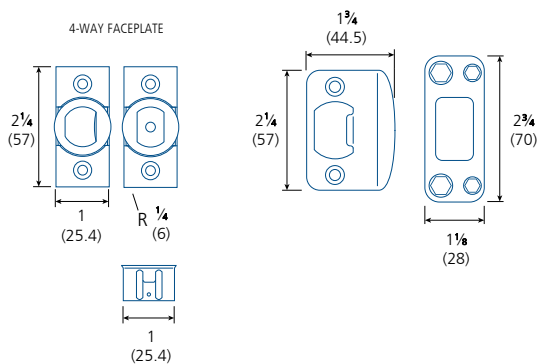

Deadbolt Locks

- ANSI/BHMA Grade 3 Security, excellent for suite entry doors and offices
- Can be keyed to insert into any key system
- Can accommodate CX5 High Security cylinders for enhanced security



- Conforms to ANSI/BHMA Grade 3
- 20 Minute fire-rating available
- 25 year mechanical warranty
- 5 year limited finish warranty
- For doors 1 3/8–1 3/4" (35–44.5 mm) thick
- Extension kit for 2 1/4" (57 mm) thick doors available (#TLA85052)
- Fits standard 2 1/8" (54 mm) door preparation with 1" (25.4 mm) edge bore
- Steel or brass 1" (25.4 mm) deadbolt latch with hardened steel security pin and adjustable 2 3/8–2 3/4" (60–70 mm) backset
- Mortise faceplate with square corners, convertible to drive-in
- Galvanized steel interior mechanism
- Removable brass cylinder in steel housing with 2 keys
- Rotating exterior collar for enhanced protection against physical attack
- Security strikes for wood and steel frames included
- Other faceplate options available



200 SERIES
SATIN NICKEL
SINGLE CYLINDER



200 SERIES
SATIN NICKEL
THUMB-TURN ONLY

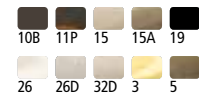

200 SERIES
SATIN STAINLESS STEEL
DOUBLE CYLINDER



AVAILABLE FUNCTIONS

- 51 Single cylinder with thumb-turn ➔
- 55 One-side, thumb-turn only
- 57 Thumb-turn with exterior plate
- 60 Double cylinder ➔

SELECTION GUIDE

| F | 201 | 51 | C15 | KD | M |
|--|---------------------|----------|--------|---------------------|--------------------|
| RATING ¹ | SERIES ² | FUNCTION | FINISH | KEYING ³ | LATCH ⁴ |
| (1) LEAVE BLANK FOR NON-RATED MODEL (2) 200 : NO KEYWAY 201 : WEISER 5-PIN 202 : SCHLAGE KEYWAY 6-PIN USE 200 WHEN ORDERING FUNCTIONS 55 OR 57 (2) KA : KEYED ALIKE KD : KEYED DIFFERENT (3) M : CONVERTIBLE MORTISE | | | | | |



For fire labelled wood doors ONLY. For details, consult local building codes and/or local authority having jurisdiction (AHJ). Separate firecan kit may be required for some finishes.

🔑 Full keying services available – please contact for details

| | C10B | C11P | C15 | C15A | C19 | C26 | C26D | C32D | C3 | C4 | C5 | C53 | V3* | /CASE |
|-------------------|-----------------|----------------|--------------|----------------|-------------|-----------------|--------------|---------------|----------------|-------------|---------------|-------------------|----------------|-------|
| | OIL RUB. BRONZE | ANTIQUE BRONZE | SATIN NICKEL | ANTIQUE NICKEL | MATTE BLACK | POLISHED CHROME | SATIN CHROME | SATIN S.STEEL | POLISHED BRASS | SATIN BRASS | ANTIQUE BRASS | ANT. / POL. BRASS | POLISHED BRASS | |
| 200 SERIES | ● | ● | ● | ● | ● | ● | ● | ● | ● | ● | ● | ● | ● | 24 |

OTHER FINISHES AVAILABLE, MINIMUM ORDER QUANTITIES AND/OR ADDITIONAL DELIVERY TIMES MAY BE REQUIRED – PLEASE CONTACT (*) LIFETIME FINISH WARRANTY

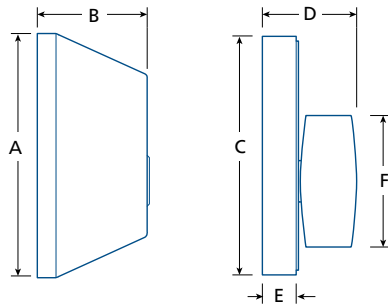

| | A | B | C | D | E | F |
|-------------------|--|---------------------------------------|---|-------------|--------------------------------------|---------------------------------------|
| 200 SERIES | ∅ 2 ⁹ / ₁₆ (65) | 1 ¹ / ₈ (29) | ∅ 2 ¹ / ₂ (63) | 1 (25.4) | 3 ³ / ₈ (9) | 1 ³ / ₈ (35) |

IN (MM)

CONVERTIBLE MORTISE FACEPLATE (OPTION M)

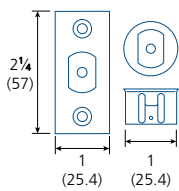

SECURITY STRIKES (WOOD / METAL)

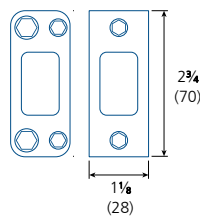

DOREX®

METRO

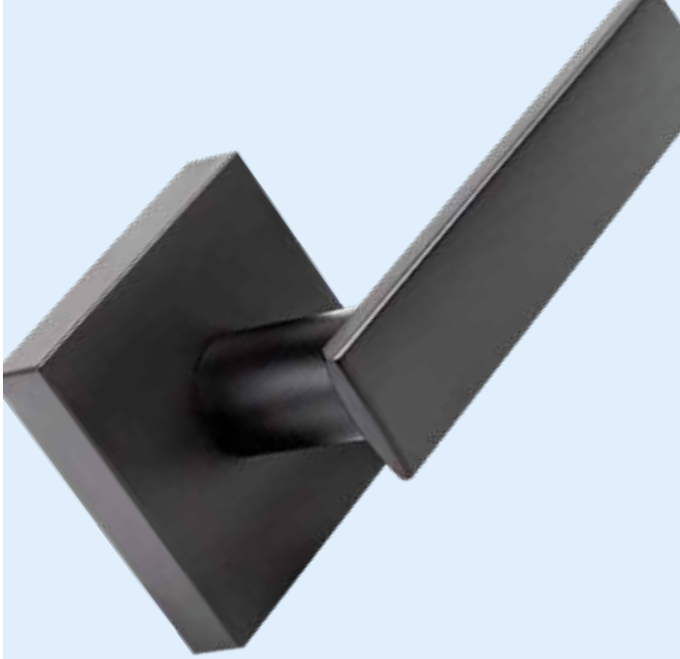

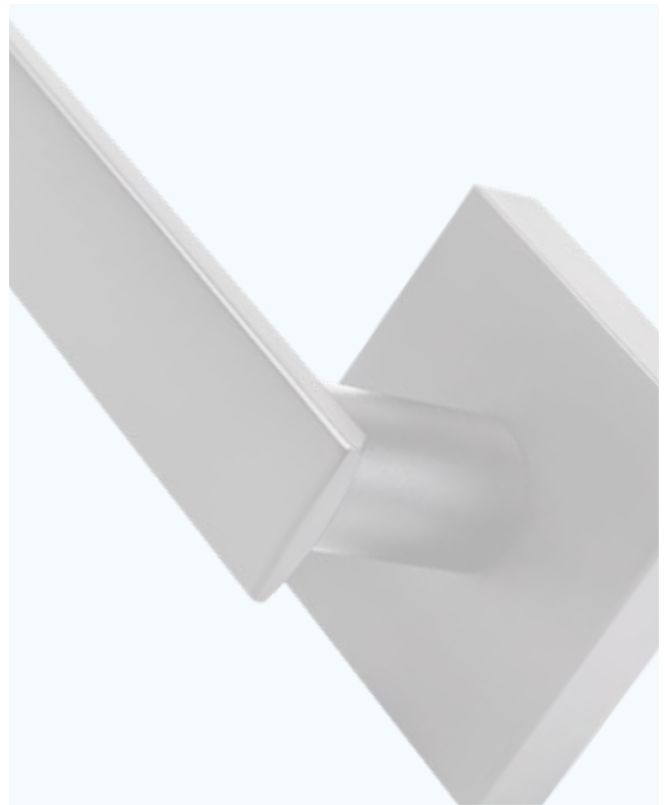

Levers

- All new collection of urban inspired, contemporary levers
- Non-handed and handed lever styles
- Privacy function with auto-release

- 1 year mechanical warranty
- 1 year limited finish warranty
- Non-handed or handed, zinc die-cast lever
- For doors $1\frac{3}{8}$ – $1\frac{3}{4}$ " (35–44.5 mm) thick
- Fits standard $2\frac{1}{8}$ " (54 mm) door preparation with 1" (25.4 mm) edge bore
- Steel tubular spring latch with adjustable $2\frac{3}{8}$ – $2\frac{3}{4}$ " (60–70 mm) backset
- 4-Way, mortise faceplate with square corners, convertible to drive-in
- Full-lip strike with round corners included
- Other faceplate options available

AVAILABLE FUNCTIONS

- 10 Passage
- 51 Entry (Livia only)
- 42 Privacy, with auto-release
- 17 Single Dummy (surface)



NERO
MATTE BLACK



ROSE



LIVIA
ANTIQUÉ NICKEL



ROSE



CASSIUS
SATIN CHROME



SELECTION GUIDE

| | | | | | | | |
|--------|----------|-------|-------------------|-------------------|--------|--------------------|---|
| V2X | 42 | Q | S | L | - | 15 | M |
| SERIES | FUNCTION | STYLE | ROSE ¹ | HAND ² | FINISH | LATCH ³ | |

(1) BLANK: ROUND S: SQUARE (2) FOR CASSIUS INDICATE R: RIGHT HAND, L: LEFT HAND
 (3) BLANK: 4-WAY; D: DRIVE-IN; M: FIXED MORTISE (SQ CORNER); MR: FIXED MORTISE (RND CORNER)

| | 10B OIL RUB. BRONZE | 11P ANTIQUÉ BRONZE | 15 SATIN NICKEL | 15A ANTIQUÉ NICKEL | 19 MATTE BLACK | 26 POLISHED CHROME | 26D SATIN CHROME | 3 POLISHED BRASS | 32D SATIN S.STEEL | 4 SATIN BRASS | 5 ANTIQUÉ BRASS | /CASE† |
|------------------|---------------------------|--------------------------|-----------------------|--------------------------|----------------------|--------------------------|------------------------|------------------------|-------------------------|---------------------|-----------------------|--------|
| LIVIA | | L | • | • | • | | • | | | | | 24 |
| NERO | | N | • | | • | | • | | | | | 24 |
| CASSIUS (HANDED) | | Q | • | | • | | • | | | | | 24 |

OTHER FINISHES/OPTIONS AVAILABLE, MINIMUM ORDER QUANTITIES AND/OR ADDITIONAL DELIVERY TIMES MAY BE REQUIRED – PLEASE CONTACT

(†) DUMMY ARE 30/CASE

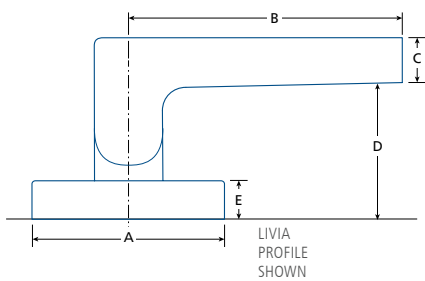

| | A | B | C | D | E |
|-----------------|--|---|---|---|--|
| LIVIA L / LS | ∅ 2 ⁹ / ₁₆ ∅ (65) | 3 ⁷ / ₈ (99.8) | 3 ⁴ / ₄ (19.5) | 1 ⁵ / ₈ (41) | 1 ⁷ / ₃₂ (13.5) |
| NERO N / NS | ∅ 2 ⁹ / ₁₆ ∅ (65) | 4 ¹ / ₁₆ (103) | 3 ⁸ / ₈ (9.5) | 2 (50.5) | 1 ⁷ / ₃₂ (13.5) |
| CASSIUS Q | ∅ 2 ⁹ / ₁₆ (65) | 4 ⁵ / ₈ (117) | 2 ⁹ / ₃₂ (23) | 1 ¹¹ / ₁₆ (43.4) | 1 ⁷ / ₃₂ (13.5) |

IN (MM)

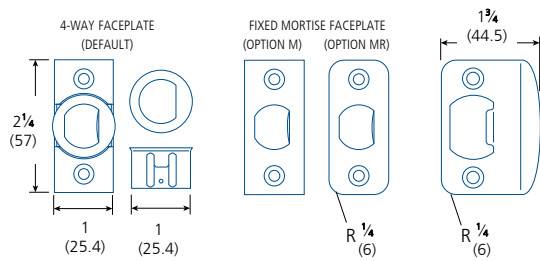

Knobs

- Mid-century inspired, contemporary door knobs that can accommodate nearly any modern decor
- Privacy function with auto-release
- Keyed entry function available
- Round or square rose

- 1 year mechanical warranty
- 1 year limited finish warranty

- Non-handed, zinc die-cast knob
- For doors $1\frac{3}{8}$ – $1\frac{3}{4}$ " (35–44.5 mm) thick
- Fits standard $2\frac{1}{8}$ " (54 mm) door preparation with 1" (25.4 mm) edge bore
- Steel tubular spring latch with adjustable $2\frac{3}{8}$ – $2\frac{3}{4}$ " (60–70 mm) backset
- 4-Way, mortise faceplate with square corners, convertible to drive-in
- Entry model includes 5-pin cylinder, Weiser keyway with 2 keys
- Full-lip strike with round corners included
- Other faceplate options available

AVAILABLE FUNCTIONS

- 10 Passage
- 42 Privacy, with auto-release
- 51 Entry 
- 17 Single Dummy (surface)



ROSE

GEMINI
SATIN NICKEL

15 19



ROSE

GEMINI
SATIN NICKEL

15 19



SELECTION GUIDE

| | | | | | | |
|------------|-----------|----------|-------------------|----------|-----------|--------------------|
| V3X | 42 | G | S | - | 15 | MR |
| SERIES | FUNCTION | STYLE | ROSE ¹ | | FINISH | LATCH ² |

(1) LEAVE BLANK FOR ROUND ROSE (2) 4-WAY LATCH BY DEFAULT; **MR**: FIXED MORTISE (RND)

| | | 10B | 11P | 15 | 15A | 19 | 26D | 3 | 4 | 5 | 53 | |
|---------------|------|-----------------|----------------|--------------|----------------|-------------|--------------|----------------|-------------|---------------|-------------------|--------|
| | | OIL RUB. BRONZE | ANTIQUE BRONZE | SATIN NICKEL | ANTIQUE NICKEL | MATTE BLACK | SATIN CHROME | POLISHED BRASS | SATIN BRASS | ANTIQUE BRASS | ANT. / POL. BRASS | /CASE† |
| GEMINI | G/GS | | | ● | | ● | | | | | | 24* |

OTHER FINISHES AVAILABLE, MINIMUM ORDER QUANTITIES AND/OR ADDITIONAL DELIVERY TIMES MAY BE REQUIRED – PLEASE CONTACT
 (†) DUMMY ARE 30/CASE (*) GEMINI ENTRY FUNCTION IS 12/CASE

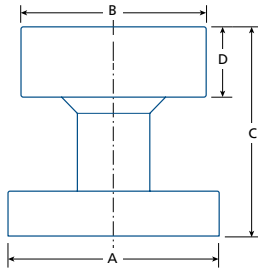

| | A | B | C | D |
|---------------|----------------------------------|-------------------------------|--------------------------------|-----------------|
| GEMINI | ∅ 2 ⁹ / ₁₆ | 2 ¹ / ₄ | 2 ⁹ / ₁₆ | 7/ ₈ |
| G/GS | ∅ (65) | (57) | (65) | (22) |

IN (MM)

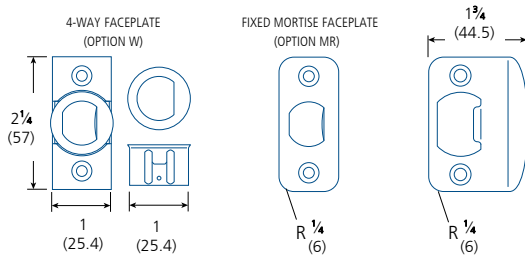

Deadbolt Locks

- Contemporary deadbolt lock styles for home and property security



METRO SQUARE
MATTE BLACK
SINGLE CYLINDER



- 20 Minute fire-rating model available
- 1 year mechanical warranty
- 1 year limited finish warranty
- For doors 1 $\frac{3}{8}$ –1 $\frac{3}{4}$ " (35–44.5 mm) thick
- Extension kit for 2 $\frac{1}{4}$ " (57 mm) thick doors available (#B1-EXT)
- Fits standard 2 $\frac{1}{8}$ " (54 mm) door preparation with 1" (25.4 mm) edge bore
- Steel 1" (25.4 mm) deadbolt latch with hardened steel security pin and adjustable 2 $\frac{3}{8}$ –2 $\frac{3}{4}$ " (60–70 mm) backset
- Mortise faceplate with square corners, convertible to drive-in
- 5-pin cylinder, Weiser keyway with 2 keys
- Strike for wood door frames included
- Other faceplate options available
- 5-pin Schlage cylinder available

AVAILABLE FUNCTIONS

- 51 Single cylinder with thumb-turn ➔

SELECTION GUIDE

| | | | | | | | |
|---------------------|----------|--------------------|--------|---------------------|--------------------|----|---|
| V11 | 51 | - | S | - | 15 | KD | M |
| SERIES ¹ | FUNCTION | STYLE ² | FINISH | KEYING ³ | LATCH ⁴ | | |

(1) **V11**: WEISER 5-PIN; **V12**: SCHLAGE 5-PIN. (2) **S**: SQUARE (3) **KA**: KEYED ALIKE **KD**: KEYED DIFFERENT (4) **M**: CONVERTIBLE MORTISE **FM**: FIRE-RATED, FIXED MORTISE (SQ CORNER)



For fire labelled wood doors ONLY. To order, specify V12 Schlage series lock with FM latch.

| STYLE | 10B OIL RUB. BRONZE | 11P ANTIQU BRONZE | 15 SATIN NICKEL | 15A ANTIQU NICKEL | 19 MATTE BLACK | 26 POLISHED CHROME | 26D SATIN CHROME | 3 POLISHED BRASS | 32D SATIN S.STEEL | 4 SATIN BRASS | 5 ANTIQU BRASS | 53 ANT. / POL. BRASS | /CASE |
|------------------------|---------------------------|-------------------------|-----------------------|-------------------------|----------------------|--------------------------|------------------------|------------------------|-------------------------|---------------------|----------------------|----------------------------|-------|
| METRO SQUARE | | | • | | • | | • | | | | | | 24 |

OTHER FINISHES AVAILABLE, MINIMUM ORDER QUANTITIES AND/OR ADDITIONAL DELIVERY TIMES MAY BE REQUIRED – PLEASE CONTACT

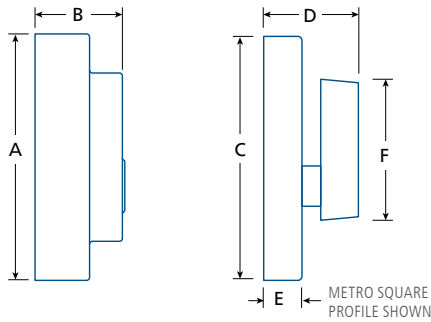

| | A | B | C | D | E | F |
|------------------------|--|-------------|---------------------------------------|--|------------|---|
| METRO SQUARE | 2 ⁹ / ₁₆ (65) | 3/4 (20) | 2 ¹ / ₂ (63) | 1 ⁹ / ₆₄ (29) | 3/8 (9) | 1 ³ / ₄ (44.5) |

IN (MM)

CONVERTIBLE FACEPLATE
(OPTION M)

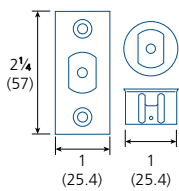

FIXED FACEPLATE
(OPTION FM)

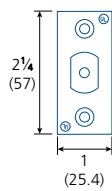

STRIKE

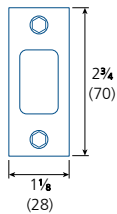

DOREX[®]

BUILDER



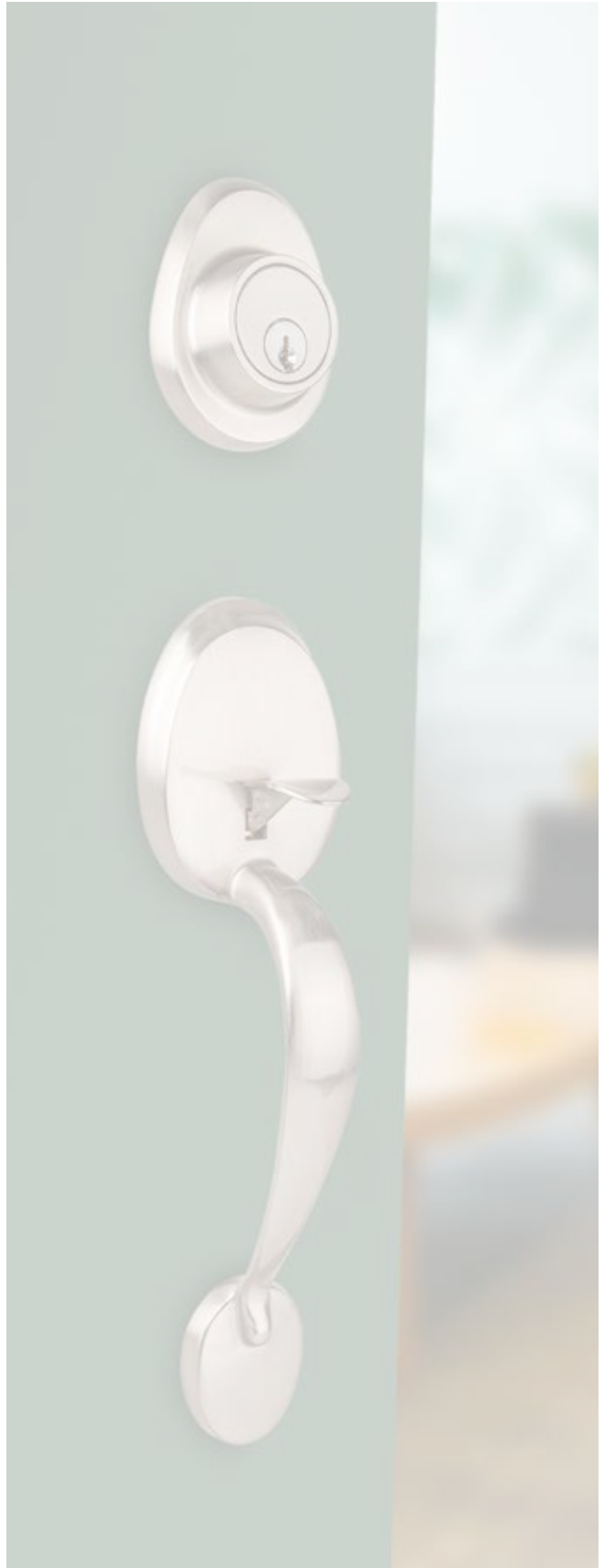

Levers

- Contemporary lever styles for residential home construction professionals
- Keyed entry function available

- 1 Year mechanical warranty
- 1 Year limited finish warranty
- Non-handed zinc die-cast lever
- For doors 1 $\frac{3}{8}$ –1 $\frac{3}{4}$ " (35–44.5 mm) thick
- Fits standard 2 $\frac{1}{8}$ " (54 mm) door preparation with 1" (25.4 mm) edge bore
- Steel tubular spring latch with adjustable 2 $\frac{3}{8}$ –2 $\frac{3}{4}$ " (60–70 mm) backset
- 4-Way, mortise faceplate with square corners, convertible to drive-in
- Entry model includes 5-pin cylinder, Weiser keyway with 2 keys
- Full-lip strike with round corners included
- Other faceplate options available

AVAILABLE FUNCTIONS

- 10 Passage
- 17 Dummy, single (surface)
- 42 Privacy
- 51 Entry ↔



EARL
SATIN NICKEL



STRAIGHT
MATTE BLACK

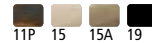

JULIA
SATIN NICKEL



ROSE



SELECTION GUIDE

| | | | | | | | |
|--------|----------|-------|-------------------|---|--------|---------------------|--------------------|
| B2X | 42 | J | S | - | 15 | KD | M |
| SERIES | FUNCTION | STYLE | ROSE ² | | FINISH | KEYING ³ | LATCH ⁴ |

(2) BLANK: ROUND; S: SQUARE (3) KD: KEYED DIFFERENT (DEFAULT); KA: KEYED ALIKE
 (4) BLANK: 4-WAY; M: FIXED MORTISE (SQ CORNER); MR: FIXED MORTISE (RND CORNER)

NOTE: ONLY THE STRAIGHT STYLE (S) IS AVAILABLE WITH KEYED ENTRY FUNCTION (S1).

| | | 10B OIL RUB. BRONZE | 11P ANTIQU BRONZE | 15 SATIN NICKEL | 15A ANTIQU NICKEL | 19 MATTE BLACK | 26 POLISH CHROME | 26D SATIN CHROME | 3 POLISH BRASS | 32D SATIN S.STEEL | 4 SATIN BRASS | 5 ANTIQU BRASS | /CASE† |
|----------|---|---------------------------|-------------------------|-----------------------|-------------------------|----------------------|------------------------|------------------------|----------------------|-------------------------|---------------------|----------------------|--------|
| EARL | E | | | ● | | | | ● | | | | | 20 |
| JULIA | J | | | ● | | ● | | | | | | | 20 |
| STRAIGHT | S | | ● | ● | ● | ● | | ● | ● | | | | 20 |

OTHER FINISHES/OPTIONS AVAILABLE, MINIMUM ORDER QUANTITIES AND/OR ADDITIONAL DELIVERY TIMES MAY BE REQUIRED – PLEASE CONTACT

(†) DUMMY ARE 30/CASE

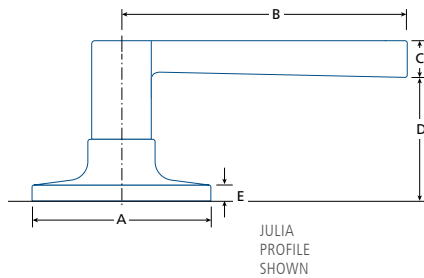

| | A | B | C | D | E |
|-----------------|--|---|---------------------------------------|---------------------------------------|--|
| EARL E | ∅ 2 ⁹ / ₁₆ (65) | 3 ¹ / ₂ (89) | ³ / ₈ (9.5) | 1 ³ / ₈ (35) | 1 ⁷ / ₃₂ (13.5) |
| JULIA J / JS | ∅ 2 ⁹ / ₁₆ (65) | 4 ⁷ / ₁₆ (112.5) | ³ / ₄ (19) | 1 ¹ / ₂ (38) | ¹ / ₄ (6.5) |
| STRAIGHT S | ∅ 2 ⁹ / ₁₆ (65) | 3 ³ / ₄ (95.3) | ³ / ₁₆ (4.8) | 2 (50.7) | ¹ / ₄ (6.5) |

IN (MM)

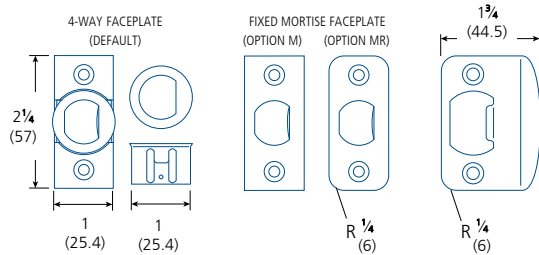

Knobs

- Versatile classic door knobs for residential home construction professionals
- Keyed entry function available

- 1 Year mechanical warranty
- 1 Year limited finish warranty
- Non handed, steel knob
- For doors $1\frac{3}{8}$ – $1\frac{3}{4}$ " (35–44.5 mm) thick
- Fits standard $2\frac{1}{8}$ " (54 mm) door preparation with 1 (25.4 mm) edge bore
- Steel tubular spring latch with adjustable $2\frac{3}{8}$ – $2\frac{3}{4}$ " (60–70 mm) backset
- 4-Way, mortise faceplate with square corners, convertible to drive-in
- Entry model includes 5-pin cylinder, Weiser keyway with 2 keys
- Full-lip strike with round corners included
- Other faceplate options available

AVAILABLE FUNCTIONS

- 10 Passage
- 42 Privacy
- 51 Entry 
- 17 Single Dummy (surface)



RONDO
SATIN CHROME



RONDO
SATIN CHROME

SELECTION GUIDE

| | | | | | | |
|------------|-----------|----------|----------|---------------------|--------------------|----------|
| B3X | 51 | R | - | 15 | KD | W |
| SERIES | FUNCTION | STYLE | FINISH | KEYING ¹ | LATCH ² | |

(1) **KD**: KEYED DIFFERENT; **KA**: KEYED ALIKE

(2) **W**: 4-WAY; **M**: FIXED MORTISE; **MR**: FIXED MORTISE (RND CORNER)

| | | 10B OIL RUB. BRONZE | 11P ANTIQUE BRONZE | 15 SATIN NICKEL | 15A ANTIQUE NICKEL | 19 MATTE BLACK | 26D SATIN CHROME | 3 POLISHED BRASS | 4 SATIN BRASS | 5 ANTIQUE BRASS | 53 ANT. / POL. BRASS | /CASE† |
|--------------|---|----------------------------------|---------------------------------|------------------------------|---------------------------------|-----------------------------|-------------------------------|-------------------------------|----------------------------|------------------------------|-----------------------------------|--------|
| RONDO | R | | ● | ● | ● | ● | ● | ● | | | ● | 30 |

OTHER FINISHES AVAILABLE, MINIMUM ORDER QUANTITIES AND/OR ADDITIONAL DELIVERY TIMES MAY BE REQUIRED – PLEASE CONTACT

(†) DUMMY ARE 60/CASE

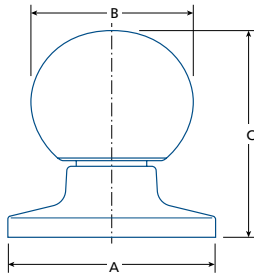

| | $\varnothing A$ | B | C |
|--------------|-----------------|------|----------------|
| RONDO | $2\frac{9}{16}$ | 2 | $2\frac{3}{4}$ |
| R | (65) | (51) | (70) |

IN (MM)

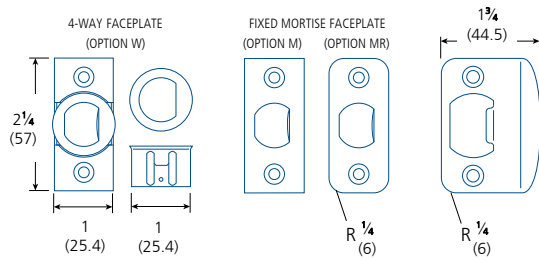

Entry Handlesets

- Classic entry handlesets for residential home construction professionals
- Non-handed
- Includes interior knob

- 1 Year mechanical warranty
- 1 Year limited finish warranty

- Non-handed, zinc die-cast exterior trim
- For doors $1\frac{3}{8}$ – $1\frac{3}{4}$ " (35–44.5 mm) thick
- Fits standard $2\frac{1}{8}$ " (54 mm) door preparation with 1" (25.4 mm) edge bore
- Stainless steel tubular spring latch with adjustable $2\frac{3}{8}$ – $2\frac{3}{4}$ " (60–70 mm) backset
- Steel 1" (25.4 mm) deadbolt latch with hardened steel security pin and adjustable $2\frac{3}{8}$ – $2\frac{3}{4}$ " (60–70 mm) backset
- Mortised faceplate with square corners, convertible to drive-in
- 5-pin cylinder, Weiser keyway with 2 keys
- Full-lip strike and security strike for wood door frames (round corners) included

AVAILABLE FUNCTIONS

- Entry ↔



SELECTION GUIDE

| | | | | | | |
|-----------|---------------------|-----------|----------|-----------|---------------------|--------------------|
| 30 | 1 | CH | B | 15 | KD | W |
| SERIES | KEYWAY ¹ | STYLE | TRIM | FINISH | KEYING ² | LATCH ³ |

(1) 1: WEISER (2) KD: KEYED DIFFERENT (3) W: MORTISE

| | | C10B OIL RUB. BRONZE | C11P ANTIQUÉ BRONZE | C15 SATIN NICKEL | C15A ANTIQUÉ NICKEL | C19 MATTE BLACK | C26 POLISHED CHROME | C26D SATIN CHROME | C3 POLISHED BRASS | C32D SATIN S.STEEL | C4 SATIN BRASS | C5 ANTIQUÉ BRASS | V3* POLISHED BRASS | /CASE |
|-------------------|----|----------------------------|---------------------------|------------------------|---------------------------|-----------------------|---------------------------|-------------------------|-------------------------|--------------------------|----------------------|------------------------|--------------------------|-------|
| CHÂTEAU | CH | | ● | ● | ● | ● | | ● | | | | | | 6 |
| LAURENTIAN | LA | | | ● | | ● | | | | | | | | 6 |
| MANOR | MN | | ● | ● | ● | ● | | ● | ● | | | | | 6 |

OTHER FINISHES AVAILABLE, MINIMUM ORDER QUANTITIES AND/OR ADDITIONAL DELIVERY TIMES MAY BE REQUIRED – PLEASE CONTACT (*) LIFETIME FINISH WARRANTY

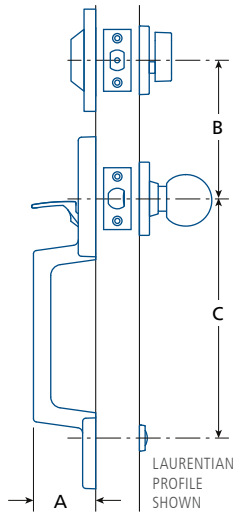

| | A | B ¹ | C ² |
|-------------------------|--|----------------|--|
| CHÂTEAU CH | 2 ⁹ / ₁₆ (65) | 5 (127) | 8 ⁷ / ₁₆ (214) |
| LAURENTIAN LA | 2 ³ / ₈ (60) | 5 (127) | 8 ⁷ / ₁₆ ⁽²⁾ (214) |
| MANOR MN | 2 ³ / ₈ (60) | 5 (127) | 8 ⁵ / ₈ (219) |

IN (MM) (1) RECOMMENDED DISTANCE (2) DEFAULT DISTANCE, CAN BE ADJUSTED TO 8 5/8" (219MM) OR 9" (228MM)

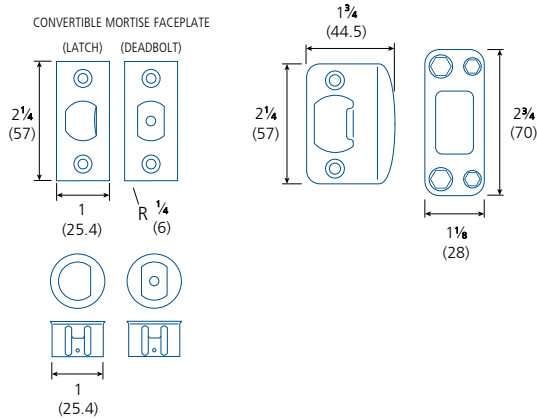

Deadbolt Locks

- Classic deadbolt for home construction professionals

- 1 Year mechanical warranty
- 1 Year limited finish warranty
- For doors $1\frac{3}{8}$ – $1\frac{3}{4}$ " (35–44.5 mm) thick
- Fits standard $2\frac{1}{8}$ " (54 mm) door preparation with 1" (25.4 mm) edge bore
- Steel 1" (25.4 mm) deadbolt latch with hardened steel security pin and adjustable $2\frac{3}{8}$ – $2\frac{3}{4}$ " (60–70 mm) backset
- 4-Way mortise faceplate with square corners, convertible to drive-in
- 5-pin cylinder, Weiser keyway with 2 keys
- Security strike for wood door frames included



CITADELLE (C)
SATIN CHROME
SINGLE CYLINDER



AVAILABLE FUNCTIONS

- 51 Single cylinder with thumb-turn ➔

SELECTION GUIDE

CITADELLE // STANDARD

| | | | | | | | |
|-----------|---------------------|-----------|----------|----------|-----------|---------------------|--------------------|
| B1 | 1 | 51 | C | - | 15 | KD | M |
| SERIES | KEYWAY ¹ | FUNCTION | TYPE | | FINISH | KEYING ² | LATCH ³ |

(1) **1:** WEISER **2:** SCHLAGE (2) **KD:** KEYED DIFFERENT (DEFAULT); **KA:** KEYED ALIKE
 (3) **W:** 4-WAY; **M:** FIXED MORTISE; **MR:** FIXED MORTISE (RND CORNER)

| STYLE | 10B OIL RUB. BRONZE | 11P ANTIQUÉ BRONZE | 15 SATIN NICKEL | 15A ANTIQUÉ NICKEL | 19 MATTE BLACK | 26 POLISHED CHROME | 26D SATIN CHROME | 3 POLISHED BRASS | 32D SATIN S.STEEL | 4 SATIN BRASS | 5 ANTIQUÉ BRASS | 53 ANT. / POL. BRASS | /CASE |
|----------------------------|---------------------------|--------------------------|-----------------------|--------------------------|----------------------|--------------------------|------------------------|------------------------|-------------------------|---------------------|-----------------------|----------------------------|-------|
| CITADELLE ROUND | | • | • | | • | | | • | • | | • | • | 24 |

OTHER FINISHES AVAILABLE, MINIMUM ORDER QUANTITIES AND/OR ADDITIONAL DELIVERY TIMES MAY BE REQUIRED – PLEASE CONTACT

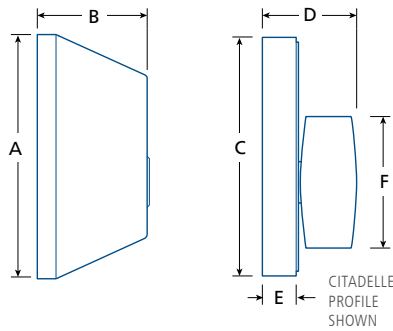

| | A | B | C | D | E | F |
|------------------|--|---------------------------------------|---|-------------|--|---|
| CITADELLE | | | | | | |
| C | ∅ 2 ⁹ / ₁₆ (65) | 1 ¹ / ₄ (32) | ∅ 2 ¹ / ₂ (63) | 1 (25.5) | 3 ³ / ₈ (9.5) | 1 ¹³ / ₃₂ (36) |

IN (MM)

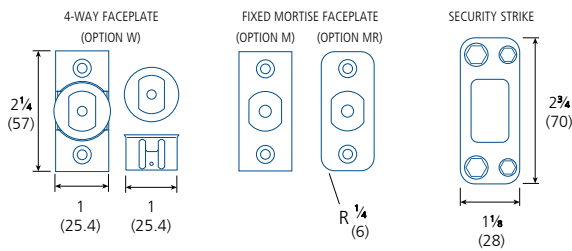

POCKET DOOR

RESIDENTIAL AUXILIARY LOCKS

POCKET DOOR LOCK

2510, 2542



2510C15
PASSAGE



2542C26D
PRIVACY

- Fits doors 1 $\frac{3}{8}$ " (35 mm) thick
- Solid brass construction
- Handed, reversible
- Privacy model includes strike
- Mounting hardware included: wood screws

DIMENSIONS

2 $\frac{1}{4}$ " D x 3 $\frac{1}{4}$ " H x 1 $\frac{3}{8}$ " W (57 x 83 x 35 mm)

MODELS

2510: Passage
2542: Privacy

| | |
|-------|--------|
| 2510 | C15 |
| MODEL | FINISH |

| C15 | C15A | C19 | C26 | C26D | C3 | C5 |
|--------------|----------------|-------------|-----------------|--------------|----------------|---------------|
| SATIN NICKEL | ANTIQUÉ NICKEL | MATTE BLACK | POLISHED CHROME | SATIN CHROME | POLISHED BRASS | ANTIQUÉ BRASS |

OTHER FINISHES AVAILABLE—PLEASE CONTACT

POCKET DOOR LOCK

2610, 2642



2610-11P
PASSAGE



2642-26D
PRIVACY



2610S-19
PASSAGE



2642S-15
PRIVACY

- Fits doors 1 $\frac{3}{8}$ –1 $\frac{3}{4}$ " (35–44.5 mm) thick with standard 160 or 161 door preparation
- Non-handed
- 2 $\frac{3}{8}$ " (60 mm) backset
- 2 $\frac{3}{4}$ " (70 mm) backset latch sold separately:
#2610L234: Passage
#2642L234: Privacy
- Spring-loaded pop-out edge pull
- Privacy model includes latch with integrated spring-loaded pop-out edge pull, dust box, and strike
- Mounting hardware included: wood screws

DIMENSIONS

Round rose: \varnothing 2 $\frac{7}{16}$ " (62 mm)

Square rose (S): \varnothing 2 $\frac{7}{16}$ " (62 mm)

Faceplate: 1 x 2 $\frac{1}{4}$ " (25.4 x 57 mm);
 $\frac{1}{4}$ " (6.4 mm) radius corners*

(*) Square corner faceplate available by special order.

MODELS

2610: Round, Passage

2642: Round, Privacy

2610S: Square, Passage

2642S: Square, Privacy

| | | |
|-------|---|--------|
| 2642 | - | 26D |
| MODEL | | FINISH |

2610 / 2642

| 11P | 15 | 15A | 19 | 26 | 26D | 3 |
|----------------|--------------|----------------|-------------|-----------------|--------------|----------------|
| ANTIQUÉ BRONZE | SATIN NICKEL | ANTIQUÉ NICKEL | MATTE BLACK | POLISHED CHROME | SATIN CHROME | POLISHED BRASS |

OTHER FINISHES AVAILABLE—PLEASE CONTACT

2610S / 2642S

| 15 | 19 | 26D |
|--------------|-------------|--------------|
| SATIN NICKEL | MATTE BLACK | SATIN CHROME |

OTHER FINISHES AVAILABLE—PLEASE CONTACT



- Certifications**
- Conforms to ANSI/BHMA A156.5, Grade 2
 - cULus listed, 2hr fire-rating
 - 3 Year limited mechanical warranty
 - 1 Year limited electronic warranty

Door Thickness • 1 $\frac{3}{8}$ –2" (35–51 mm)

Handing • Non handed

Backset • 2 $\frac{3}{8}$ –2 $\frac{3}{4}$ " (60–70 mm) adjustable

Deadbolt • Steel with hardened steel security pin
• 1" (25.4 mm) throw

Faceplate • Mortise type, square corners
• 1 x 2 $\frac{1}{4}$ " (25.4x57 mm)

Strike • Security strike (wood frame), square corners
• 1 $\frac{1}{8}$ x2 $\frac{3}{4}$ " (28.5x70 mm)

Chassis • Steel cylinder housing
• Exposed mounting screws
• Exterior rubber gasket

Preparation • Cross bore: 2 $\frac{1}{8}$ " or 1 $\frac{1}{2}$ " (54 or 38mm)
• Edge bore: 1" (25.4 mm)

Cylinder • Solid brass, 5-pin (drilled 6)
• Schlage "C" keyway, 2 keys
• Removable, rekeyable

Other keyways and keying options available, including CX5 high security.

Interface • Digital touch keypad
• Blue LED back-light

- Electronic Features**
- 1 Programming code (8 digit)
 - 25 User codes (4–8 digits)
 - 4 Renewable single use codes
 - Auto Lock with delay (99 sec. maximum)
 - Vacation Mode (disables keypad)
 - Optional random screen keypad activation code to prevent number probing
 - Low battery power indicator

Wireless Protocol • RFID - MIFARE™ 13.56MHz (Classic 1K)
• 25 RFID token capacity
• 2 RFID cards included*
• Two-factor authentication mode available (requires user code and RFID token)

(Other single or dual frequency key fobs and bracelets available by special order.*

Power • DC 6V

Four (4) AA 1.5V alkaline batteries NOT included

Operation Temperature • -31° to 150.8°F (-35° to 66°C)
Temperature tolerance can vary due to weather conditions

Function 51 Single cylinder, thumb-turn

Finish 15–Satin nickel, 19–Matte black

Other finishes available by special order

| | | | | | | | | | | | | | | |
|------|---|--------|---|----------|---|--------|--|----------|--|--------|--|-------|---|--------|
| ASM | - | F400T | - | NR | - | 2 | | 51 | | KD | | M | - | 15 |
| TYPE | | SERIES | | PROTOCOL | | KEYWAY | | FUNCTION | | KEYING | | LATCH | | FINISH |

SELECTION GUIDE

| SERIES | DESCRIPTION | FINISH ¹ | /CASE |
|--------------|---|---------------------|-------|
| ASM-F400T-NR | RFID Electronic deadbolt with LED digital touch keypad.  | 15, 19 | 6 |

(1) OTHER FINISHES AVAILABLE, MINIMUM ORDER QUANTITIES AND/OR ADDITIONAL DELIVERY TIMES MAY BE REQUIRED
 KEYED FUNCTION; FULL KEYING SERVICES AVAILABLE

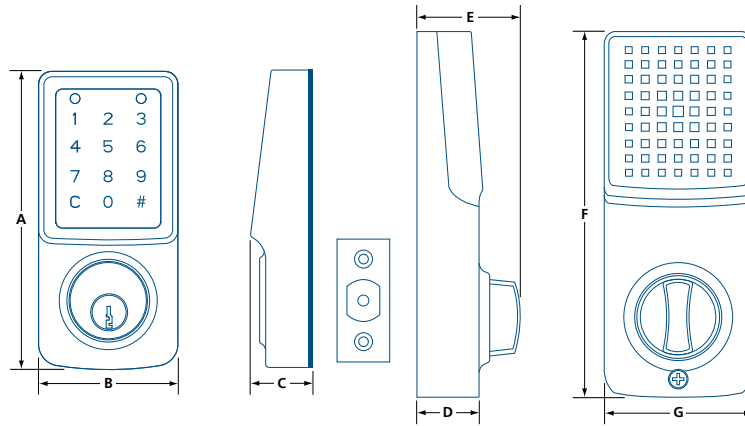

| | A | B | C | D | E | F | G |
|-------|---|---------------------------------------|---------------------------------------|---------------------------------------|-------------|--|---------------------------------------|
| F400T | 5 ⁷ / ₁₆ (138) | 2 ¹ / ₂ (65) | 1 ¹ / ₈ (29) | 1 ¹ / ₈ (30) | 2 (51.5) | 6 ¹³ / ₁₆ (173) | 2 ³ / ₄ (70) |

IN (MM)

PARTS & ACCESSORIES



A-F400-PBC
Replacement battery cover for F400T.



A-F4-PDW
11 in (28 cm) data wire.



A-PDMF-BU
Single frequency RFID (13.56 MHz),
Classic 1K key fob.



B1-EXT
Extension Kit, for 2" to 2¹/₄" (51 to 57mm)
thick doors.



A-F400-PIG
Optional rubber gasket for interior trim
for F400T. *Not included.*







- Certifications**
- Conforms to ANSI/BHMA A156.2, Grade 2
 - 3 Year limited mechanical warranty
 - 1 Year limited electronic warranty
- Door Thickness**
- 1 3/8"–2" (35–51 mm)
- Handing**
- Non handed
- Backset**
- 2 3/8"–2 3/4" (60–70 mm) adjustable
- Spring Latch**
- Zinc alloy
 - 1/2" (12.7 mm) throw
- Faceplate**
- Mortise type, square corners
 - 1 x 2 1/4" (25.4 x 57 mm)
- Strike**
- T-Type, square corners
 - 1 1/8 x 2 3/4" (28.5 x 70 mm) wood frame
- Chassis**
- Zinc die-cast levers
 - Lever clutch release
 - Exposed mounting screws
 - Interior / exterior trim gaskets
- Preparation**
- Cross bore: 2 1/8" (54 mm)
 - Edge bore: 1" (25.4 mm)
- Cylinder**
- Solid brass, 5-pin
 - Schlage "C" keyway, 2 keys
 - Removable, rekeyable
- Other keyways and keying options available. May require special order.*
- Interface**
- Digital touch keypad
 - Blue LED back-light

- Electronic Features**
- 1 Programming code (8 digit)
 - 25 User codes (4–8 digits)
 - 4 Renewable single use codes
 - Auto Lock with delay (99 sec. maximum)
 - Vacation Mode (disables keypad)
 - Optional random screen keypad activation code to prevent number probing
 - Low battery power indicator
- Wireless Protocol**
- RFID - MIFARE™ 13.56 MHz (Classic 1K)
 - 25 RFID token capacity
 - 2 RFID cards included*
 - Two-factor authentication mode available (requires user code and RFID token)
- (* Other single or dual frequency key fobs and bracelets available by special order.)*
- Power**
- DC 6V
- Four (4) AA 1.5V alkaline batteries NOT included.*
- Operation Temperature**
- -31° to 150.8°F (-35° to 66°C)
- Temperature tolerance can vary due to weather conditions.*
- Function**
- 80 Storeroom
- Lever Style**
- JN–Juno (default), C–Curved return*, H–Standard return*
- (* May require additional lead time.)*
- Finish**
- 15–Satin nickel, 19–Matte black
- Other finishes available by special order.*

| | | | | | | | | | | | | | | | | |
|------|---|--------|---|----------|---|--------|--|----------|--|--------|--|-------|---|-------|---|--------|
| ASM | - | F425T | - | NR | - | 2 | | 80 | | KD | | M | - | JN | - | 15 |
| TYPE | | SERIES | | PROTOCOL | | KEYWAY | | FUNCTION | | KEYING | | LATCH | | LEVER | | FINISH |

SELECTION GUIDE

| SERIES | DESCRIPTION | STYLE ¹ | FINISH ² | / CASE |
|--------------|--|--------------------|---------------------|--------|
| ASM-F425T-NR | RFID Electronic lever lockset with LED digital touch keypad.  | JN, C, H | 15, 19 | 4 |

(1) OPTIONAL C, H STYLE LEVERS MAY REQUIRE ADDITIONAL LEAD TIME (2) OTHER FINISHES AVAILABLE, MINIMUM ORDER QUANTITIES AND/OR ADDITIONAL DELIVERY TIMES MAY BE REQUIRED.
 KEYED FUNCTION; FULL KEYING SERVICES AVAILABLE.

OPTIONAL LEVERS



(C) Curved return



(H) Standard return

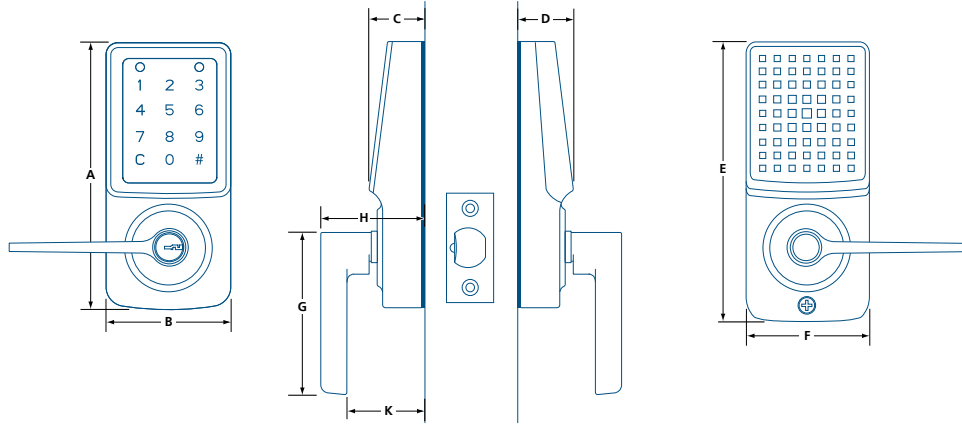

| | A | B | C | D | E | F | G | H | K |
|------------------------|--|-----------|---|---------------------------------------|--|---|--|---|-------------|
| F425T JN (JUNO) | 6 ¹ / ₈ (155) | 3 (76) | 1 ¹¹ / ₃₂ (34) | 1 ¹ / ₄ (32) | 6 ¹ / ₈ (155) | 2 ²⁹ / ₃₂ (74) | 4 ²⁵ / ₃₂ (121.2) | 2 ²⁷ / ₃₂ (72.5) | 2 (50.8) |

IN (MM)

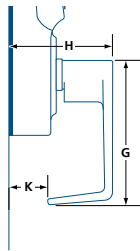
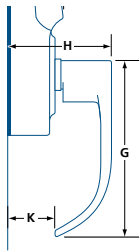

| | G | H | K |
|----------------|--|---|--|
| F425T C | 4 ¹¹ / ₁₆ (118.9) | 2 ²⁷ / ₃₂ (72.5) | 1 ³ / ₃₂ (27.7) |
| F425T H | 4 ³ / ₁₆ (106.2) | 2 ²⁷ / ₃₂ (72.5) | 1 (25.6) |

IN (MM)

PARTS & ACCESSORIES



A-F425-PBC
Replacement battery cover for F425T.



A-F425-PST
Replacement screen trim for F425T.



A-PDMF-BU
Single frequency RFID (13.56 MHz),
Classic 1K key fob.



B1-EXT
Extension Kit, for 2" to 2¹/₄" (51 to 57mm)
thick doors.





- Certifications**
- Conforms to ANSI/BHMA A156.5, Grade 2
 - cULus listed, 20min fire-rating
 - UL 1034, Safety for Burglary-Resistant Electric Locking Mechanisms
 - 3 Year limited mechanical warranty
 - 1 Year limited electronic warranty

Door Thickness • 1³/₈–2" (35–51 mm)

Handing • Non handed

Backset • 2³/₈–2³/₄" (60–70 mm) adjustable

Deadbolt • Steel with hardened steel security pin
• 1" (25.4 mm) throw

Faceplate • Mortise type, square corners
• 1 x 2¹/₄" (25.4 x 57 mm)

Strike • Security strike (wood frame), square corners
• 1¹/₈ x 2³/₄" (28.5 x 70 mm)

Chassis • Steel cylinder housing
• Exposed mounting screws
• Integrated all-weather seal

Preparation • Cross bore: 2¹/₈" or 1¹/₂" (54 or 38 mm)
• Edge bore: 1" (25.4 mm)

Cylinder • Solid brass, 5-pin (drilled 6)
• Schlage "C" keyway, 2 keys
• Removable, rekeyable

Other keyways and keying options available, including CX5 high security.

Interface • Digital touch keypad
• White LED back-light

Electronic Features • iKey Connect mobile app control (iOS / Android)

- 200 User credentials per lock
- PIN codes can be single use, scheduled, or permanent
- Optional keyless entry (geofencing)
- Optional auto-lock with delay (900 sec. max.)
- Optional random keypad activation code to prevent number probing
- Vacation mode (disables keypad)
- Audit trail (accessible via app)
- Low battery power indicator (in-app / on-device)
- Multi-lock management*

() Local touring, lock-to-phone management, see instructions for details.*

Protocol • BLE Pairing (128-bit encryption)

Operation • -31° to 150.8°F (-35° to 66°C)

Temperature *Temperature tolerance can vary due to weather.*

Power • DC 6V

Four (4) AA 1.5V alkaline batteries NOT included

Function 51 Single cylinder, thumb-turn

Finish 15–Satin nickel, 19–Matte black

Other finishes available by special order

| | | | | | | | | | | | | | | |
|------|---|--------|---|----------|---|--------|--|----------|--|--------|--|-------|---|--------|
| AMM | - | F500T | - | NB | - | 2 | | 51 | | KD | | M | - | 15 |
| TYPE | | SERIES | | PROTOCOL | | KEYWAY | | FUNCTION | | KEYING | | LATCH | | FINISH |



SELECTION GUIDE

| SERIES | DESCRIPTION | FINISH ¹ | /CASE |
|---------------------|--|---------------------|-------|
| AMM-F500T-NB | Smart BLE Electronic deadbolt with LED digital touch keypad.  | 15, 19 | 6 |

(1) OTHER FINISHES AVAILABLE, MINIMUM ORDER QUANTITIES AND/OR ADDITIONAL DELIVERY TIMES MAY BE REQUIRED

 KEYED FUNCTION; FULL KEYING SERVICES AVAILABLE

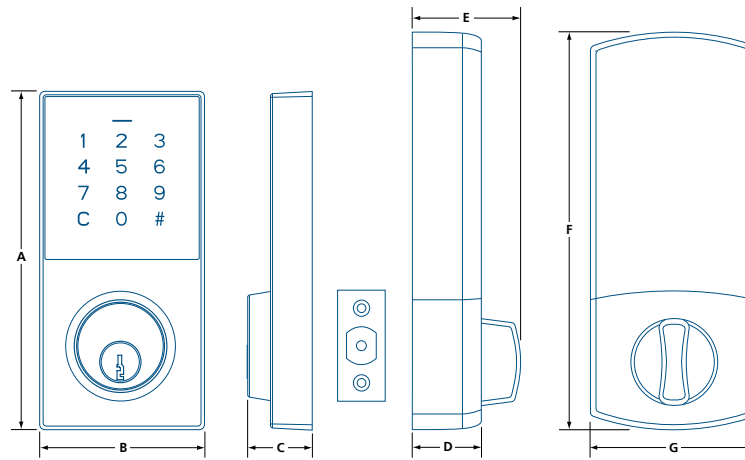

| | A | B | C | D | E | F | G |
|--------------|--|---------------------------------------|-----------|---------------------------------------|---------------------------------------|---|---------------------------------------|
| F500T | 5 ³ / ₈ (136) | 2 ⁵ / ₈ (66) | 1 (26) | 1 ¹ / ₈ (28) | 1 ³ / ₄ (44) | 6 ⁵ / ₁₆ (160) | 2 ⁵ / ₈ (67) |

IN (MM)

PARTS & ACCESSORIES



A-F4-PDW
11 in (28 cm) data wire.



B1-EXT
Extension Kit, for 2" to 2¹/₄" (51 to 57mm) thick doors.



ER SERIES

ELECTRONIC DEADBOLT



1
YEAR



REMOTE CONTROL
INCLUDED

- Certifications** • 1 Year limited warranty
- Door Thickness** • 1 $\frac{3}{8}$ –2" (35–51 mm)
- Handing** • Non handed
- Backset** • 2 $\frac{3}{8}$ –2 $\frac{3}{4}$ " (60–70 mm), adjustable
- Deadbolt** • Steel bolt with hardened steel security pin
• 1" (25.4 mm) throw
- Faceplate** • Mortise type, square corner
• 1 $\frac{1}{8}$ x2 $\frac{1}{4}$ " (29x57 mm)
- Strike** • 1 $\frac{1}{8}$ x2 $\frac{3}{4}$ " (29x70 mm) wood frame
- Preparation** • Cross bore: 2 $\frac{1}{8}$ " (54 mm)
• Edge bore: 1" (25.4 mm)
See installation instructions for details
- Cylinder** • 5-pin, removable cylinder
• Weiser keyway, 2 keys
Other keyways and keying options available

- Electronic Features** • Battery powered*, low battery indicator
• LED illuminated keyboard
• Fully programmable from keyboard, no computer required
• For up to 6 users (4 to 10 digit code)
• Settings saved in memory
• Visual and audio confirmation and notifications
• Remote control (98 ft/30 m range) included
• Auto-locking function available
() Four (4) AA batteries not included*

- Operating Temperature** • -4° to 185°F (-20° to 85°C)
• 30 to 90% humidity
Rubber gaskets prevent water penetration

- Functions** 51 Single cylinder, thumbturn

- Styles** ER–Traditional body, SER–Contemporary body

- Finish** 11P–Antique bronze, 15–Satin nickel, 15A–Antique nickel, 19–Matte black, 26D–Satin chrome, V3–Polished brass (lifetime)
Other finishes available by special order

| | | | | | |
|--------|----------|-------|--------|--------|--------------------|
| 201 | 51 | SER | 26D | KD | U |
| SERIES | FUNCTION | STYLE | FINISH | KEYING | LATCH ¹ |

(1) U–UNIVERSAL LATCH, CONVERTS TO DRIVE-IN

SELECTION GUIDE

| MODEL | DESCRIPTION | FINISH |
|----------|---|---------------------------|
| 20151ER | Electronic deadbolt with LED keypad & remote, traditional style. ➤ | 11P, 15, 15A, 19, 26D, V3 |
| 20151SER | Electronic deadbolt with LED keypad & remote, contemporary style. ➤ | 15, 15A, 19, 26D |

OTHER FINISHES AVAILABLE, MINIMUM ORDER QUANTITIES AND/OR ADDITIONAL DELIVERY TIMES MAY BE REQUIRED
 ➤ KEYED FUNCTION; FULL KEYING SERVICES AVAILABLE

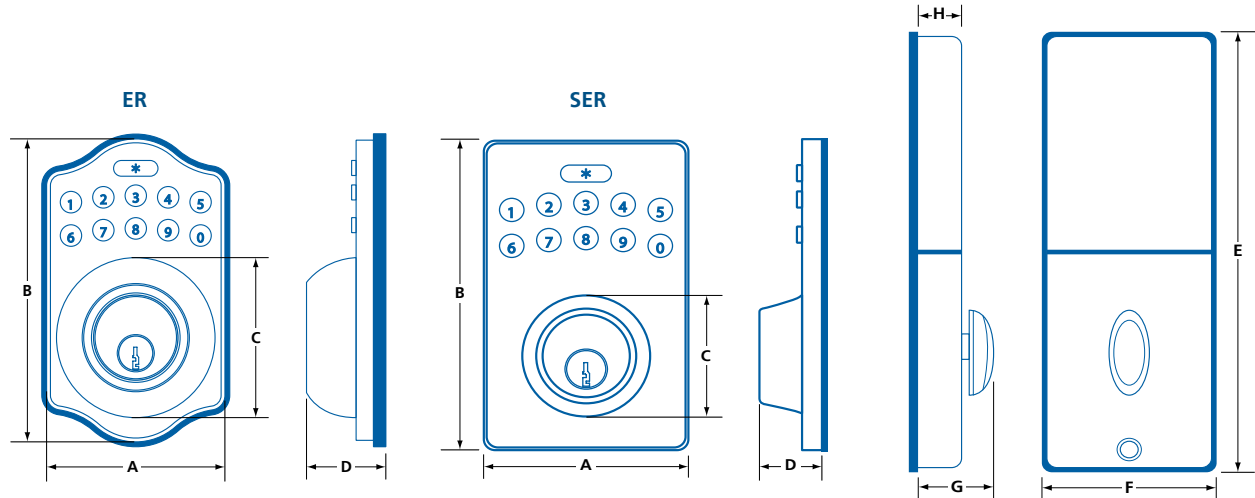

| | A | B | C | D | E | F | G | H |
|------------|--------------|----------------|----------------|--------------|--------------|----------------|--------------|---------------|
| ER | 27/8 (73) | 47/8 (124) | 29/16 (65) | 13/8 (35) | 7/4 (184) | 211/16 (68) | 13/4 (44) | 11/16 (27) |
| SER | 3 (76) | 49/16 (116) | 115/16 (49) | 11/8 (29) | 7/4 (184) | 211/16 (68) | 13/4 (44) | 11/16 (27) |

IN (MM)

PARTS & ACCESSORIES



200ERC

Additional remote control with override key.
 Battery included.



- Reliable, quality, and convenient modern electronic entry handleset for residential homes
- Includes F500 smart electronic deadbolt, classic interior lever and exterior handle
- Control and configure your lock using the intuitive iKey mobile application. Grant access to family, guests or service providers with a simple tap on your device. Available for both iOS and Android smartphones.



- Deadbolt conforms to ANSH/BHMA Grade 2
- UL 1034, Safety for Burglary-Resistant Electric Locking Mechanisms
- 3-year limited mechanical warranty
- 1-year limited finish warranty
- 1-year limited electronic warranty
- Non-handed, zinc die-cast exterior trim
- For doors 1¾–2¼" (44.5–57 mm) thick
- Fits standard 2½" (54 mm) door preparation with 1" (25.4 mm) edge bore
- Steel tubular spring latch with adjustable 2¾–2¾" (60–70 mm) backset.
- Steel 1" (25.4 mm) deadbolt latch with hardened steel security pin and adjustable 2¾–2¾" (60–70 mm) backset
- Mortised faceplate with square corners, convertible to drive-in
- Integrated all-weather seal for outdoor use
- Deadbolt operated by touchscreen or key
- 5-pin brass cylinder in steel housing with 2 keys
- Full-lip strike and 2-piece deadbolt strike and dustbox included
- Handle with adjustable mounting post
- Requires 4 AA batteries (not included)

ELECTRONIC FEATURES

- Digital touchscreen, blue LED backlight
- 200 User credentials per lock
- PIN Codes can be single use, scheduled, or permanent
- Optional keyless entry (geofencing)
- Optional auto-lock with delay (900 sec. max.)
- Optional random keypad activation code to prevent number probing
- Vacation mode (disables keypad)
- Audit trail (accessible via app)
- Low battery power indicator (in-app / on-device)
- Multi-lock management* – manage multiple F500 locks with one app

(* Local touring, lock-to-phone management, see instructions for details.



SATIN NICKEL



SELECTION GUIDE

| | | | | | | | | | | | | |
|--------|----------|--------------------|---------------------|----------|--------|-------|--------|----|---|---|----|--|
| F500T | - | NB | - | LAS | - | 1 | 51 | KD | M | - | 15 | |
| SERIES | PROTOCOL | STYLE ¹ | KEYWAY ² | FUNCTION | KEYING | LATCH | FINISH | | | | | |

(1) LAS: LEVER WITH ROUND ROSE (2) 1: SCHLAGE; 2: WEISER

| | 10B | 11P | 15 | 15A | 19 | 26 | 26D | 3 | 32D | 4 | C5 | V3* | /CASE |
|-------------------|-----------------|---------------|--------------|---------------|-------------|-----------------|--------------|----------------|---------------|-------------|--------------|----------------|-------|
| | OIL RUB. BRONZE | ANTIQU BRONZE | SATIN NICKEL | ANTIQU NICKEL | MATTE BLACK | POLISHED CHROME | SATIN CHROME | POLISHED BRASS | SATIN S.STEEL | SATIN BRASS | ANTIQU BRASS | POLISHED BRASS | |
| T500 COMBO | LAS | | ● | | ● | | | | | | | | 6 |

OTHER FINISHES AVAILABLE, MINIMUM ORDER QUANTITIES AND/OR ADDITIONAL DELIVERY TIMES MAY BE REQUIRED – PLEASE CONTACT (*) LIFETIME FINISH WARRANTY

DIMENSIONS

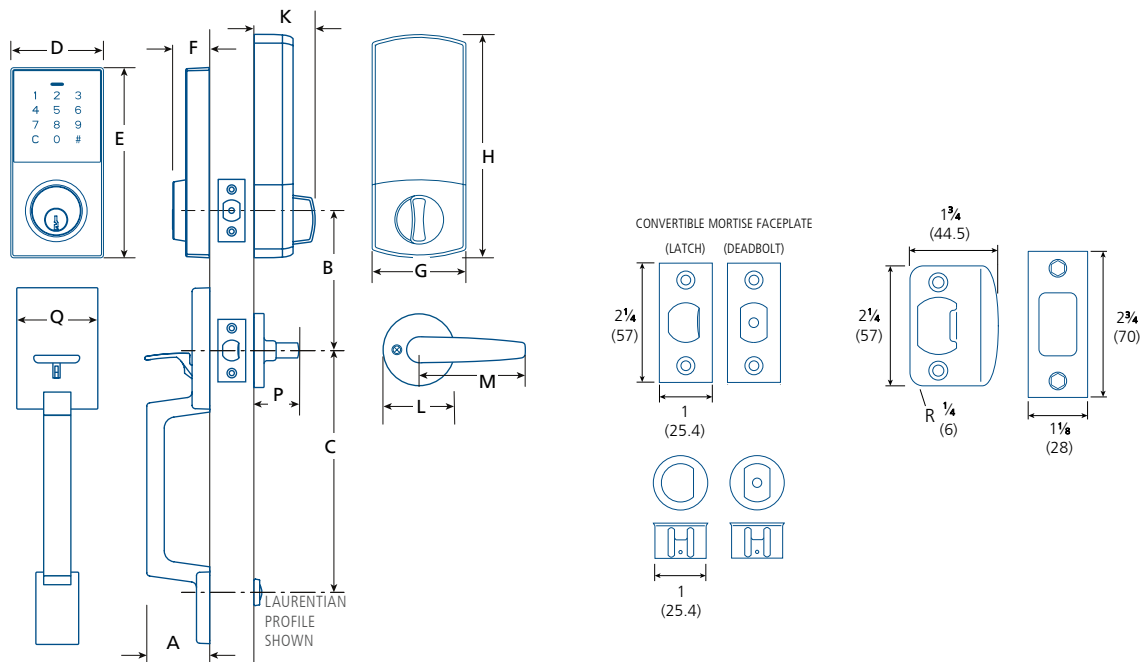

| | A | B ¹ | C | D | E | F | G | H | K | L | M | P | Q |
|-------------------|-------|----------------|--------------------------|-------|-------|------|-------|--------|-------|--------|--------|--------|--------|
| T500 COMBO | 2 1/4 | 5 | 8 7/16 (214) | 2 3/8 | 5 1/2 | 1 | 2 5/8 | 6 5/16 | 1 3/4 | 2 9/16 | 3 1/2 | 2 | 2 3/16 |
| LAS | (54) | (127) | 8 5/8 (219) ² | (60) | (139) | (26) | (67) | (160) | (44) | (65) | (88.9) | (50.8) | (62) |
| | | | 8 30/32 (228) | | | | | | | | | | |

IN (MM) (1) RECOMMENDED DISTANCE (2) DEFAULT MOUNTING DISTANCE



- Reliable and convenient modern electronic entry handleset for residential single family homes
- Concealed mounting screws
- Includes T300 electronic deadbolt, Linea interior lever and Delta exterior handle
- Interior lever can be swapped with any other Tecnica Design lever¹
- Available with round or square interior trim

(1) Availability may vary, please contact your local Dorex representative.

- 3-year limited mechanical warranty
- 5-year limited finish warranty
- 1-year limited electronic warranty
- Non-handed, zinc die-cast exterior trim
- For doors 1¾–2¼" (44.5–57 mm) thick
- Fits standard 2½" (54 mm) door preparation with 1" (25.4 mm) edge bore
- Steel tubular spring latch with adjustable 2¾–2¾" (60–70 mm) backset.
- Steel 1" (25.4 mm) deadbolt latch with hardened steel security pin and adjustable 2¾–2¾" (60–70 mm) backset
- Mortised faceplate with square corners, convertible to drive-in
- Galvanized steel interior mechanism
- Temperature: -20° to 60°C (-4° to 140°F)
- Weiser 5-pin brass cylinder in steel housing with 2 keys
- Full-lip strike and deadbolt security strike for wood door frames included

ELECTRONIC FEATURES

- Deadbolt operated by touchscreen keypad or key
- Can handle up to 70 user codes, and 5 renewable single-use codes
- Proximity sensor lights keypad when approached
- Anti-fingerprint surface prevents code guessing
- Touchscreen keypad stays lit for 30 seconds after activity
- Automatic locking for peace of mind
- Vacation mode deactivates the keypad while away
- Low battery indicator (audible and visible)
- Requires four (4) 1.5v AA batteries (not included)



SELECTION GUIDE

| | | | | | | | | | | | | |
|---------------------------------------|----------|-------|-------------------|--------|----------|--------|-------|--------|----|---|---|----|
| T300T | - | N | - | DT | LTS | - | 1 | 51 | KD | M | - | 15 |
| SERIES | PROTOCOL | STYLE | TRIM ¹ | KEYWAY | FUNCTION | KEYING | LATCH | FINISH | | | | |
| (1) LTS: LINEA SQUARE LT: LINEA ROUND | | | | | | | | | | | | |

| | 10B | 11P | 15 | 15A | 19 | 26 | 26D | 3 | 32D | 4 | C5 | V3* | /CASE |
|-------------------|-----------------|---------------|--------------|---------------|-------------|-----------------|--------------|----------------|---------------|-------------|--------------|----------------|-------|
| | OIL RUB. BRONZE | ANTIQU BRONZE | SATIN NICKEL | ANTIQU NICKEL | MATTE BLACK | POLISHED CHROME | SATIN CHROME | POLISHED BRASS | SATIN S.STEEL | SATIN BRASS | ANTIQU BRASS | POLISHED BRASS | |
| T300 COMBO | | | • | | • | | | | | | | | 6 |

OTHER FINISHES AVAILABLE, MINIMUM ORDER QUANTITIES AND/OR ADDITIONAL DELIVERY TIMES MAY BE REQUIRED – PLEASE CONTACT (*) LIFETIME FINISH WARRANTY

DIMENSIONS

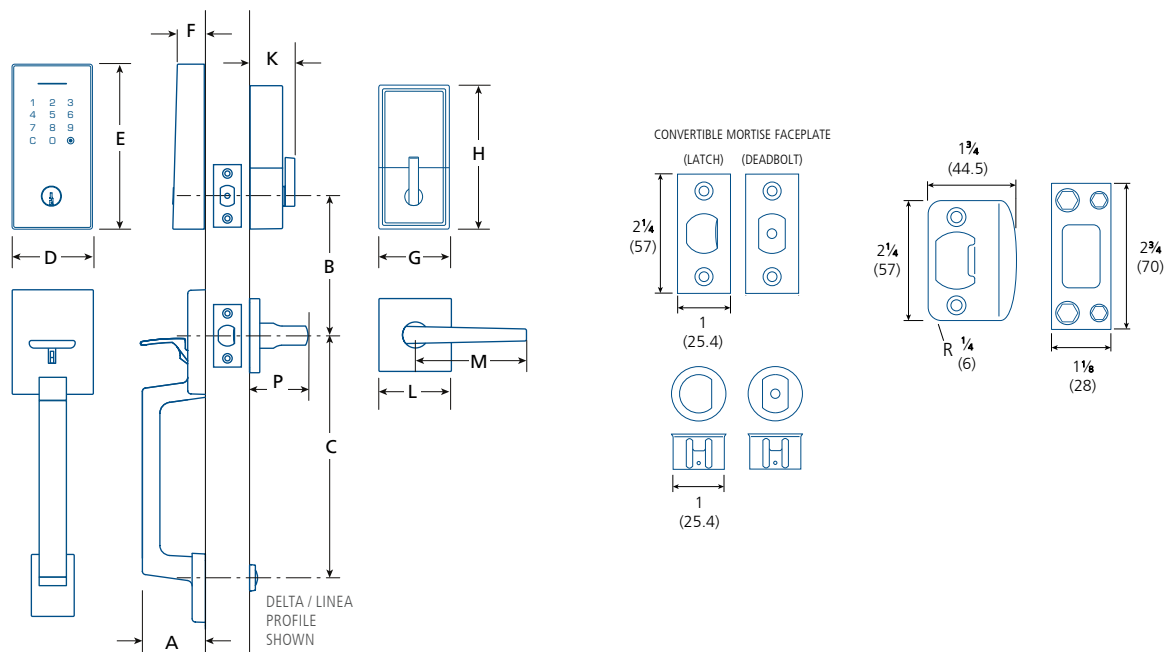

| | A | B | C | D | E | F | G | H | K | L | M | P |
|-------------------|-------|-------|---------|-------|-------|--------|---------|--------|-------|--------|-------|-------|
| T300 COMBO | 2 1/8 | 5 1 | 8 13/32 | 2 5/8 | 5 3/4 | 1 | 2 11/16 | 5 3/16 | 1 1/2 | 2 9/16 | 4 | 2 3/8 |
| DT LTS | (54) | (127) | (214) | (66) | (146) | (25.4) | (68) | (132) | (38) | (64.5) | (102) | (60) |

IN (MM) (1) RECOMMENDED DISTANCE



DDL 1150 SERIES

DIGITAL LOCKSET



- Certifications** • 1 Year limited warranty
- Door Thickness** • 1 $\frac{3}{8}$ "–2" (35–51 mm)
- Handing** • Handed
- Backset** • 2 $\frac{3}{4}$ " (70 mm)
• 2 $\frac{3}{8}$ " (60 mm) – available
- Latch** • Stainless steel deadlatch
• $\frac{1}{2}$ " (12.7 mm) throw
- Faceplate** • Mortise type, square corners
• 1 $\frac{1}{8}$ "x2 $\frac{1}{4}$ " (29x57 mm)
- Strike** • 1 $\frac{1}{8}$ "x2 $\frac{3}{4}$ " (29x70 mm)
• Plastic dust-box
- Chassis** • Zinc alloy case with rubber seal
• Stainless steel mechanical push buttons
• Exposed mounting screws

- Preparation** • Cross bore: 2 $\frac{1}{8}$ " (54 mm)
• Edge bore: 1" (25.4 mm)
- Cylinder** —
- Function** Exterior lever always locked unless unlocked by entering correct combination or by inside lever.
- Lever Style** Lever with curved return
- Finish** SC–Satin chrome
Other finishes available by special order
- Notes** • Recommended for indoor use only
• Completely mechanical, no batteries required
• Easy combination changes

| | | | |
|--------|--------|---|-------------------|
| 1150 | SC | – | LH |
| SERIES | FINISH | | HAND ¹ |

(1) LH– LEFT HAND; RH– RIGHT HAND

DIMENSIONS

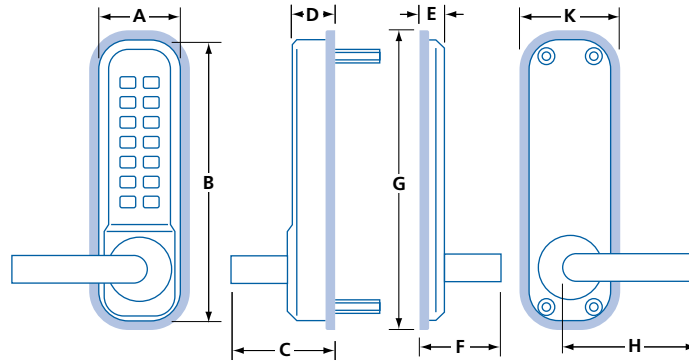

| | A | B | C | D | E | F | G | H | K |
|-------------|-------------------------|---------------------------|-------------------------|--------------------------|--------------------------|-------------------------|--------------------------|---------------------------|--------------------------|
| 1150 | 2 $\frac{1}{8}$ (54) | 7 $\frac{9}{16}$ (185) | 2 $\frac{1}{2}$ (64) | 1 $\frac{5}{16}$ (33) | 1 $\frac{3}{16}$ (20) | 2 $\frac{1}{4}$ (57) | 7 $\frac{1}{2}$ (190) | 4 $\frac{5}{16}$ (110) | 2 $\frac{7}{16}$ (62) |

IN (MM)

PARTS & ACCESSORIES



DLSC238

Deadlatch bolt, 2 $\frac{3}{8}$ " (60mm) backset,
1 $\frac{1}{8}$ x2 $\frac{1}{4}$ " (29x57 mm) faceplate

DLSC234

Deadlatch bolt, 2 $\frac{3}{4}$ " (70mm) backset,
1 $\frac{1}{8}$ x2 $\frac{1}{4}$ " (29x57 mm) faceplate



DDL 2200 SERIES

DIGITAL LOCKSET



- Certifications** • 1 Year limited warranty
- Door Thickness** • $1\frac{3}{8}$ "–2" (35–51 mm)
• $2\frac{1}{4}$ " (57 mm) – available
- Handing** • Non handed
- Backset** • $2\frac{3}{4}$ " (70 mm)
• $2\frac{5}{8}$ " (60 mm) – available
• 2200 : $1\frac{1}{8}$ " (28 mm)
- Latch** • 2200: deadbolt; $\frac{7}{8}$ " (22 mm) throw
• 2212: deadbolt with security pin;
1" (25.4 mm) throw
• 2230: security deadlatch;
 $\frac{1}{2}$ " (12.7 mm) throw
- Faceplate** • Mortise type, square corners
• $1\frac{1}{8}$ x $2\frac{1}{4}$ " (29x57 mm)
• 2200: None, not applicable
- Strike** • T-Type; $1\frac{1}{8}$ x $2\frac{3}{4}$ " (29x70 mm)
• Plastic dust-box
• 2200: includes surface strike
- Chassis** • Zinc alloy case with rubber seal
• Stainless steel mechanical push buttons
• Exposed mounting screws

- Preparation** • Special, see installation instructions for details
• Trim plate for installation on doors with
 $2\frac{1}{8}$ " (54 mm) preparation – available
• 2200: surface mounted, fits any flat surface
door and frame

Cylinder —

- Function** Exterior knob always locked unless unlocked
by entering correct combination, or by turning
inside thumb-turn.

Knob Style Flat knob with ridges

Large diameter knob available – see parts & accessories

Finish AB–Antique bronze, PB–Polished brass,
SC–Satin chrome, SN–Satin nickel

Other finishes available by special order

- Notes** • Recommended for indoor use only
• Completely mechanical, no batteries required
• Easy combination changes

| | |
|-------|--------|
| 2230 | SC |
| MODEL | FINISH |

SELECTION GUIDE

| MODEL | DESCRIPTION | FINISH |
|-------|--|------------|
| 2200 | Combination deadbolt lock, surface mounted, 1½" (28mm) backset | SC |
| 2212 | Combination deadbolt lock, 2¾" (70mm) backset | AB, PB, SC |
| 2230 | Combination deadlatch lock, 2¾" (70mm) backset | SC, SN |

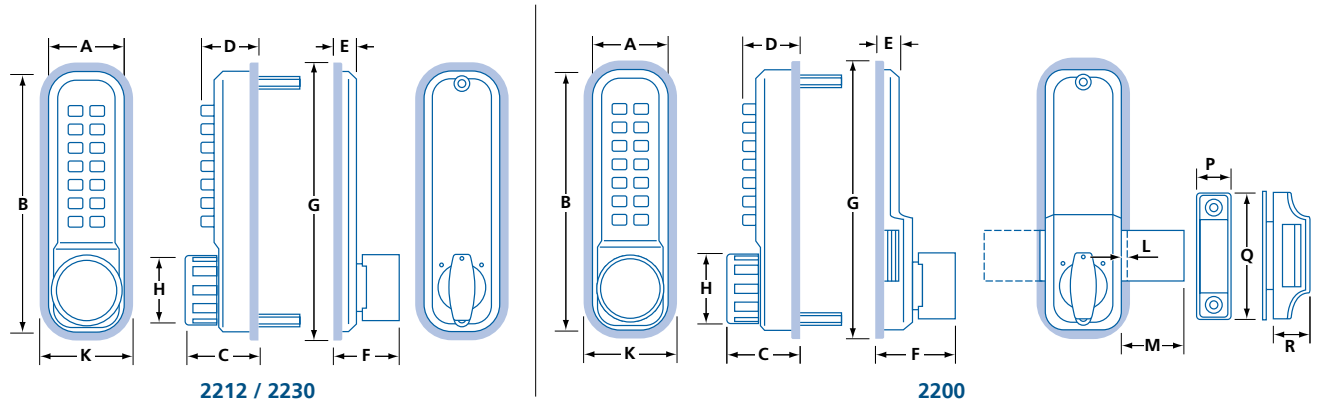

| | A | B | C | D | E | F | G | H | K | L | M | P | Q | R |
|-------------|---------------|-----------------|----------------|----------------|----------------|---------------|------------|----------------|-----------|-------------|-------------|---------------|--------------|-------------|
| 2200 | | | | | | | | | | 1/16 (2) | 7/8 (22) | 25/32 (20) | 23/4 (70) | 7/8 (22) |
| 2212 | 1 5/8 (41) | 5 9/16 (143) | 1 9/16 (40) | 1 3/16 (30) | 1 5/32 (12) | 1 5/8 (42) | 6 (152) | 1 7/16 (36) | 2 (51) | — | — | — | — | — |
| 2230 | | | | | | | | | | — | — | — | — | — |

IN (MM)

PARTS & ACCESSORIES



DLSC238
Deadlatch bolt, 2¾" (60mm) backset,
1½x2¼" (29x57mm) faceplate



DLSC234
Deadlatch bolt, 2¾" (70mm) backset,
1½x2¼" (29x57mm) faceplate



DBS238
Deadbolt, 2¾" (60mm) backset,
1½x2¼" (29x57mm) faceplate

DBS234
Deadbolt, 2¾" (70mm) backset,
1½x2¼" (29x57mm) faceplate

DETTP
Metal 2½x6½" (64x165mm) retro-fit trim
plate for pre-drilled 2½" (54mm) doors.

DETPR
Rubber 2½x6½" (64x165mm) retro-fit trim
gasket for pre-drilled 2½" (54mm) doors.



KNOB
Easy-grip knob, 1¾" (44mm) diameter.
» Antique brass (KNOBAB)
» Polished brass (KNOBBP)



RP2200
2¼" (57mm) door kit for DDL 2200.

RP2210
2¼" (57mm) door kit for DDL 2212,2230.



PF SERIES

GLASS DOOR LOCKS

1
YEAR



PF210
PASSAGE



SILENT LATCH



PF251
ENTRY (KIK CYLINDER)



PF251P
PROFILE CYLINDER

Warranty • 1 Year limited warranty

Panel Thickness • For tempered glass panels
5/16–1/2" (8–12.7 mm) thick

Handing • Handed, field reversible*
(*) Handing conversion is possible only from
LH to RH or LHR to RHR (and vice versa).
See handing guide.

Spring Latch • Stainless steel
• Derlin stripe for silent/smooth operation

Strike • ASA strike – available
• Metal frame strike – available
• Glass panel strike – available
*Strikes not included, sold separately.
See Parts & Accessories*

Trim • High strength zinc-alloy body
• Stainless steel covers
*Levers not included, sold separately.
See Parts & Accessories*

Chassis • Concealed mounting
• Shims and gaskets included

Preparation • Glass cut-out required. See installation
instructions for details

Cylinder • 5-pin cylinder
• Schlage "C" keyway, 2 keys
• Removable
• Profile cylinders sold separately
Keying services available.

Functions 200 Glass panel strike
210 Passage
251 Entry
251P Entry, profile cylinder (less core)

Levers • Wide variety of lever styles
• Sold separately – see Parts & Accessories

Finish 630–Satin stainless steel
19–Matte black

| PF | 251 | LH | – | 630 | – | V2 |
|--------|-----------------------|------|---|--------|---|----------------------|
| SERIES | FUNCTION ¹ | HAND | | FINISH | | VERSION ³ |

(1) SEE SELECTION CHART FOR DETAILS.

(2) LH: LEFT RH: RIGHT LHR: LEFT, REVERSED RHR: RIGHT, REVERSED.

(3) VERSION AVAILABILITY VARIES PER MODEL DURING PHASE-OUT PERIOD.
FORM, FIT, AND FUNCTION REMAIN UNAFFECTED.



SELECTION GUIDE

| SERIES | FUNCTION / DESCRIPTION | FINISH ¹ |
|--------|--|---------------------|
| PF | 210 Passage | 630, 19 |
| PF | 251 Entry, cylinder included ↔ | 630, 19 |
| PF | 251P Entry, profile cylinder (less core) | 630, 19 |
| PF | 200 Strike for glass side panel | 630, 19 |

(1) OTHER FINISHES AVAILABLE, MINIMUM ORDER QUANTITIES AND/OR ADDITIONAL DELIVERY TIMES MAY BE REQUIRED. ↔ KEYED FUNCTION; FULL KEYING SERVICES AVAILABLE.

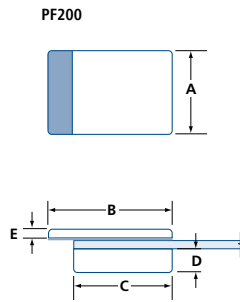
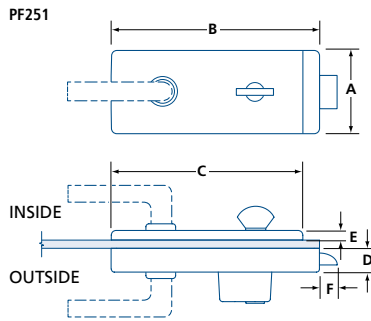

Handing Guide

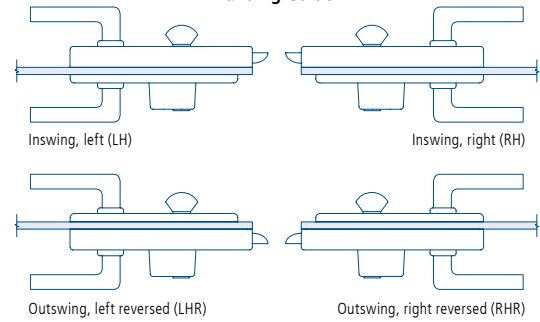

| | A | B | C | D | E | F |
|-----------------|---------------------------------------|--|--|-------------------------|-------------------------|---|
| PF210 | 2 ⁵ / ₈ (67) | 6 ¹ / ₂ (165) | 5 ⁷ / ₈ (150) | 7/ ₈ (22) | 5/ ₁₆ (8) | 7/ ₁₆ (11) |
| PF251 | 2 ⁵ / ₈ (67) | 6 ¹ / ₂ (165) | 5 ⁷ / ₈ (150) | 7/ ₈ (22) | 5/ ₁₆ (8) | 2 ⁹ / ₆₄ - 2 ³ / ₃₂ (11.5-18.5)* |
| PF251-V2 | 2 ⁵ / ₈ (67) | 6 ¹ / ₂ (165) | 5 ⁷ / ₈ (150) | 7/ ₈ (22) | 5/ ₁₆ (8) | 7/ ₁₆ (11) |
| PF200 | 2 ⁵ / ₈ (67) | 3 (76) | 2 ³ / ₈ (60) | 7/ ₈ (22) | 5/ ₁₆ (8) | - |

IN (MM) (*) LATCH EXTENDED TO 18.5MM WHEN LOCKED

PARTS & ACCESSORIES



PFL001-32D
Straight lever style (sold in pairs).



PFL018-32D
Curved lever style (sold in pairs).



CBPT1530-SCKD-15
Schlage "C" keyway profile cylinder with thumb-turn. Not rekeyable. For LH/RH PF251P locks.



CBPT3131-SCKD-15
Schlage "C" keyway profile cylinder with thumb-turn. Not rekeyable. For LHR/RHR PF251P lock.



9203
Viro profile cylinder, double cylinder brass plated. Required for master key systems with PF251P. Rekeyable.



LS01
For metal door frames 1³/₄" to 2" (44.5 mm to 50 mm) thick. Includes dust-box, mounting plate and machine screws.



ASAC15
ASA strike for 1³/₄" to 2" (44.5 mm to 50 mm) door frame. 1¹/₄x4⁷/₈" (32x124 mm)



PF200
Patch fitting lock strike for glass side panel up to 1⁹/₃₂" (15 mm) thick.



PF SERIES

GLASS DOOR FLOOR DEADBOLTS

1
YEAR



PF181
FLOOR DEADBOLT



PF180
FLOOR DEADBOLT

Warranty • 1 Year limited warranty

Panel Thickness • For tempered glass panels
5/16–1/2" (8–12.7 mm) thick

Handing • Non-handed

Deadbolt • Solid zinc-alloy floor bolt
• 1 1/16" (17.5 mm) throw
• PF180: round bolt, 3/32" (2.4 mm) thick
• PF181: flat bolt, 3/32" (2.4 mm) thick

Strike • Steel floor strike
• Dust-proof floor strike – available*

(*) For PF180 only. See Parts & Accessories

Trim • High strength zinc-alloy body
• Stainless steel covers

Chassis • Concealed mounting
• Shims and gaskets included

Preparation • Glass cut-out required. See installation instructions for details

Cylinder • PF180: 4-pin profile double cylinder
• PF181: 5-pin profile double cylinder
• Yale keyway, 3 keys

Other keyways and keying options available.



Finish 630–Satin stainless steel
19–Matte black*

(*) Special order. Other finishes also available by special order

| | | | |
|--------|-----------------------|---|--------|
| PF | 180 | – | 630 |
| SERIES | FUNCTION ¹ | | FINISH |

(1) SEE SELECTION CHART FOR DETAILS

SELECTION GUIDE

| SERIES | FUNCTION / DESCRIPTION | FINISH ¹ | / CASE |
|--------|---|---------------------|--------|
| PF 181 | Flat floor bolt, 5-pin profile double cylinder  | 630, 19* | ** |
| PF 180 | Round floor bolt, 4-pin profile double cylinder  | 630, 19* | ** |

(1) OTHER FINISHES AVAILABLE, MINIMUM ORDER QUANTITIES AND/OR ADDITIONAL DELIVERY TIMES MAY BE REQUIRED. (*) SPECIAL ORDER, MAY REQUIRE ADDITIONAL DELIVERY TIME
 (**) CONTACT LOCAL REPRESENTATIVE FOR DETAILS.  KEYED FUNCTION; FULL KEYING SERVICES AVAILABLE.

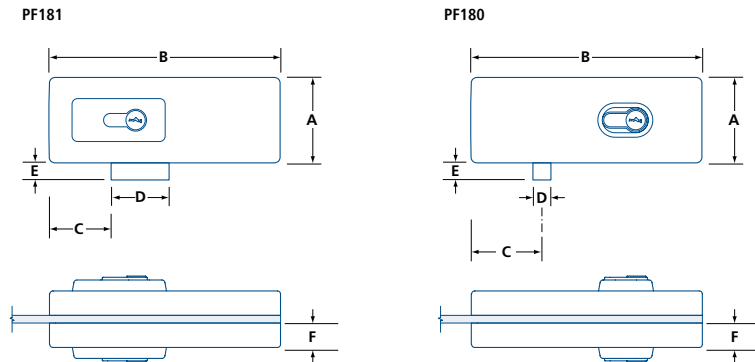

| | A | B | C | D | E | F |
|-------|-----------|---|---|--|--|---------------------------------------|
| PF181 | 2 (51) | 6 ⁷ / ₁₆ (163.3) | 2 ¹ / ₈ (54) | 1 ⁷ / ₁₆ (36) | 1 ¹ / ₁₆ (17.5) | 3 ³ / ₈ (9) |
| PF180 | 2 (51) | 6 ⁷ / ₁₆ (163.3) | 3 ¹⁵ / ₃₂ (87.7) | 9 ⁹ / ₁₆ (14.6) | 1 ¹ / ₁₆ (17.5) | 5 ⁵ / ₁₆ (8) |

IN (MM)

PARTS & ACCESSORIES



CBPT3131-SCKD-15
 Schlage "C" keyway profile cylinder with thumb-turn for PF181 locks.



9203
 Viro profile cylinder, brass plated. Required for master key systems with PF181.



T840
 Aluminum dust-proof strike with spring loaded plunger; 3/4" (19 mm) engagement depth. Can be used with PF180. See page 06.305.



DSP / DSPL
 Adjustable stainless steel dust-proof strike with spring loaded plunger; 3/4" (19 mm) engagement depth. Available with locking (DSPL) and non-locking plunger (DSP). Can be used with PF180. See page 06.305.

