



# DOOR LOCKS TABLE OF CONTENTS

Door Handing Guide.....	ii
Finish Guide.....	ii
Abbreviation Guide.....	iii
Function Guides.....	iv

## COMMERCIAL LOCKSETS

DOREX F1 Series, Cylindrical, Lever, Grade 1 <b>BHMA</b> .....	01.010
DOREX GX1 Series, Cylindrical, Lever, Grade 1 <b>BHMA</b> .....	01.012
DOREX F Series, Cylindrical, Lever, Grade 2 <b>BHMA</b> .....	01.020
DOREX T2 Series, Cylindrical, Lever, Grade 2.....	01.021
DOREX RW Series, Cylindrical, Lever, Grade 2.....	01.023
DOREX CW Series, Cylindrical, Lever, Grade 2.....	01.024
DOREX EM Series, Cylindrical, Lever, Grade 2.....	01.026
DOREX GX1B Series, Cylindrical, Knob, Grade 1.....	01.030
DOREX TL Series, Cylindrical, Knob, Grade 2.....	01.032
DOREX T2B Series, Cylindrical, Knob, Grade 2.....	01.034
DOREX IL Series, Interconnected Cylindrical, Lever, Grade 2.....	01.040
DOREX T2IL Series, Interconnected Tubular, Lever, Grade 2.....	01.042
DOREX GX1A Series, Deadbolt, Grade 1.....	01.050
DOREX FHA Series, Deadbolt, Grade 2.....	01.052
DOREX TLA Series, Deadbolt, Grade 2.....	01.054
DOREX DG1 Series, Gatelatch, Grade 1.....	01.060
DOREX DG2 Series, Gatelatch, Grade 2.....	01.062

## MORTISE LOCKSETS

DOREX DM Series, Mortise, Grade 1 <b>BHMA</b> .....	01.070
DOREX DMDBL Series, Mortise Deadbolt, Grade 1.....	01.074

## RESIDENTIAL LOCKSETS

DOREX Tecnica Design, Grade 3.....	01.210
DOREX Signature, Grade 3.....	01.230
DOREX Metro.....	01.240
DOREX Builders.....	01.260

## MISCELLANEOUS LOCKSETS

Pocket Door Locks.....	01.300
------------------------	--------

## COMBINATION LOCKSETS

DOREX F400T Series, Deadbolt, RFID, Electronic Touch Keypad, Grade 2.....	01.400
DOREX F425T Series, Lever, RFID, Electronic Touch Keypad, Grade 2.....	01.402
DOREX F500T Series, Smart Electronic Deadbolt, Grade 2.....	01.405
ER Series, Deadbolt, Electronic Keypad.....	01.410
DOREX F500 Combo Electronic Entry Handleset.....	01.415
DOREX T300 Combo Electronic Entry Handleset.....	01.416
DDL 1150 Series, Lever, Mechanical Keypad.....	01.420
DDL 2200 Series, Knob, Mechanical Keypad.....	01.422

## PATCH FITTING LOCKSETS

PF Series, Patch Fitting, Lever.....	01.500
PF Series, Patch Fitting, Deadbolt.....	01.510
DOREX PLH900 Series, Universal Patch Lock & Strike Housing.....	01.520





**DOREX**

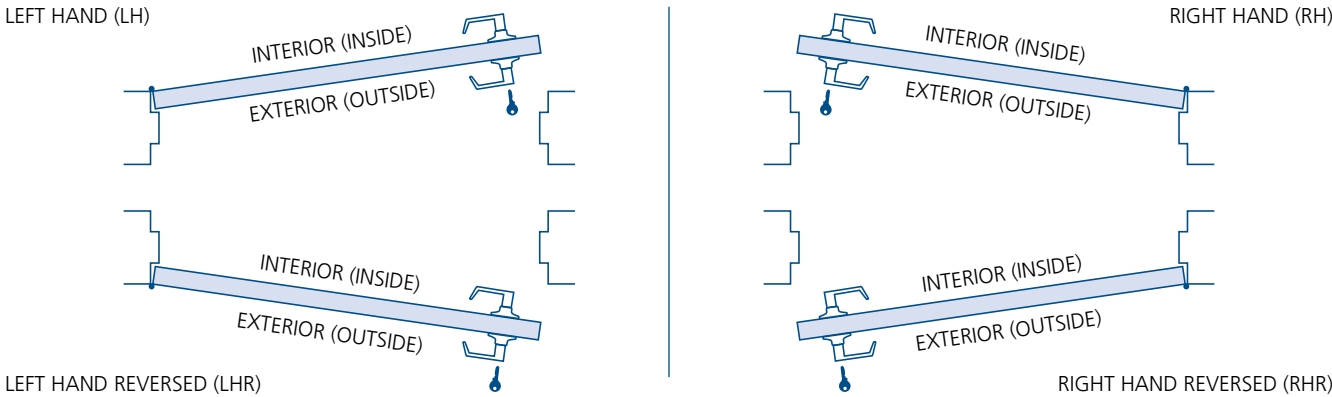

DOOR HANDING GUIDE



FINISH GUIDE

				
<b>POLISHED BRASS</b>	<b>POLISHED BRASS (ENDURANCE)</b>	<b>SATIN BRASS</b>	<b>ANTIQUÉ BRASS</b>	<b>SATIN BRONZE</b>
CODE BP, C3, 3	V3	C4, 4, SDB	AB, C5, 5	C10, 10
BHMA* 605, 632		633	609, 638	639
				
<b>OIL RUBBED BRONZE<sup>(1)</sup></b>	<b>ANTIQUÉ BRONZE</b>	<b>POLISHED NICKEL</b>	<b>SATIN NICKEL</b>	<b>ANTIQUÉ NICKEL</b>
CODE C10B, 10B	C11P, 11	C14, 14	SDN, C15, 15	C15A, 15A
BHMA* 640	617, 644	645	619, 646	620, 647
				
<b>MATTE BLACK</b>	<b>DARK BRONZE / DURANODIC</b>	<b>POLISHED CHROME</b>	<b>SATIN CHROME</b>	<b>POLISHED STAINLESS STEEL</b>
CODE C19, 19	BLR, DU, C20D, 20D	C26, 26	C26D, 26D	C32, 32
BHMA* 622, 631	649, 650, 690	625, 651	626, 652	629
				
<b>SATIN STAINLESS STEEL</b>				
CODE SS, C32D, 32D				
BHMA* 630				

ALL FINISHES IMAGES ABOVE ARE PHOTOGRAPHIC OR COLOUR APPROXIMATIONS, DELIVERED PRODUCT MAY VARY IN COMPARISON OR BETWEEN ORDERS/LOTS.  
**OTHER FINISHES AVAILABLE—PLEASE CONTACT.**  
 (\*) EQUIVALENT; CODES DIFFER DEPENDING ON BASE MATERIAL AND/OR FINISH PROCESS.  
 (1) OIL RUBBED BRONZE IS A «LIVING FINISH» WHOSE APPEARANCE WILL CHANGE OVER TIME.















## DOOR LOCKS GENERAL INFORMATION

### ABBREVIATION GUIDE

#### GENERAL











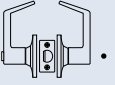

BS	Backset
DIA, Ø	Diameter
KG	Kilograms
LBS	Pounds
LH	Left hand
LHR	Left hand reversed
MAX	Maximum
MIN	Minimum
N/A, —	Not applicable / Not available
QTY	Quantity (usually followed by notes)
RH	Right hand
RHR	Right hand reversed
SQ, ▣	Square
WT	Weight
/UNIT	Number of items per basic unit of sale (bagged or boxed)
/BOX, /BAG	Number of UNITS found in an inner carton or bag
/CASE	Number of BOXES or UNITS found in an outer (shipping) carton

### LEGEND

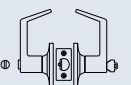

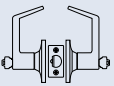
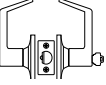
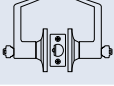
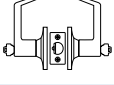
  	FIRE RATED product. Sometimes includes duration of fire-resistance in minutes (M) or hours (H).
	Small or Large Format Interchangeable Core (SFIC/LFIC) model or option available.
	Keyed product or function. Keying services may be available.
	Product, configuration or option meets ADA (Americans with Disabilities Act) requirements.
	GRADE 1 product meets or exceeds standardized testing requirements for high traffic, commercial applications.
	GRADE 2 product meets or exceeds standardized testing requirements for moderate traffic, commercial applications.
	GRADE 3 product meets or exceeds standardized testing requirements for light traffic, commercial or residential applications.
	Tested to Canadian and/or American safety and performance standards by Underwriters Laboratories® (UL).
	Certified by the Builders Hardware Manufacturers Association® / American National Standards Institute®.
	Product is equipped with or works with Radio-frequency Identification (RFID) readers or tags.
  	Limited warranty length in years, applicable to mechanical, electronic, or finish aspects of a product.

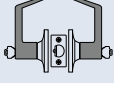

## DOOR LOCKS GENERAL LOCKSET FUNCTION GUIDE

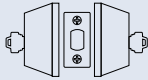
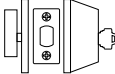

FUNCTION	DESCRIPTION	ANSI	INSIDE / OUTSIDE
10 PASSAGE	Latch bolt operated by lever from either side.	F75	
15 EXIT	Deadlocking latch bolt operated by inside lever. Blank plate on outside.	—	
17 SINGLE DUMMY 00	Lever and rose for one side of door to match other locksets.	—	
32 PATIO	Deadlocking latch bolt operated by lever from either side, except when inside push button locks outside lever. Push button released by turning inside lever or closing door to prevent lock-out.	F77	
42 PRIVACY 40	Latch bolt operated by lever from either side, except when inside push button locks outside lever. Push button released by turning inside lever or closing door to prevent lock-out. Outside lever has provision for emergency unlocking.	F76	
51 ENTRY, OFFICE	Deadlocking latch bolt operated by lever from either side, except when inside push button locks outside lever. Push button released by turning inside lever. Outside lever is unlocked / locked by key.	—	
52 ENTRY	Deadlocking latch bolt operated by lever from either side, except when inside button is pushed and turned (with tool) to lock outside lever for entry by key only. Outside lever remains locked until push button is turned.	F109	
53 ENTRY	Deadlocking latch bolt operated by lever from either side, except when inside button is pushed and turned to lock outside lever for entry by key only. Outside lever remains locked until push button is turned.	F109	
60 STORE	Deadlocking latch bolt operated by lever from either side. A key used on either side locks or unlocks both sides. NOTE: for use in rooms with more than one exit.	F91	
70 CLASSROOM	Deadlocking latch bolt operated by lever from either side, except when outside lever is locked by key. Inside lever is always free to allow exit.	F84	
72 COMMUNICATING	Deadlocking latch bolt operated by lever on either side. Levers are always rigid when locked. Key in either lever locks or unlocks its own lever independently. NOTE: For use in rooms with more than one exit.	F80	
75 CLASSROOM SECURITY	Deadlocking latch bolt operated by lever from either side. Key in either lever locks or unlocks outside lever. Inside lever is always free to allow exit.	F110	
79 INSTITUTION EXIT	Deadlocking latch bolt operated by inside lever. Locked or unlocked by key from inside lever. Blank plate outside.	—	
80 STOREROOM	Deadlocking latch bolt operated by inside lever or key in outside lever. Outside lever always rigid.	F86	
82 INSTITUTION or UTILITY	Deadlocking latch bolt operated by key in either side. Both levers always rigid.	F87	
94 HOTEL or MOTEL	Deadlocking latch bolt operated by inside lever or key in outside lever. Inside push-button prevents use except by emergency key and projects visual occupancy indicator outside. Push-button released by closing door or turning inside knob. Outside lever always rigid.	F93	

## DOOR LOCKS GENERAL DEADBOLT FUNCTION GUIDE

FUNCTION	DESCRIPTION	INSIDE / OUTSIDE
42 PRIVACY	Deadbolt operated by outside emergency key (or tool) or inside thumb turn at all times.	
51 SINGLE CYLINDER	Deadbolt operated by outside key or inside thumb turn at all times.	
55 ONE SIDED or THUMBTURN ONLY	Deadbolt operated by inside thumb turn only at all times.	
57 ONE SIDED, EXTERIOR PLATE or THUMBTURN ONLY, EXTERIOR PLATE	Deadbolt operated by inside thumb turn only at all times. Blank plate on outside.	
60 DOUBLE CYLINDER	Deadbolt operated by key in either cylinder at all times. NOTE: for use in rooms with more than one exit.	
70 SINGLE CYLINDER, CLASSROOM	Deadbolt engaged by outside key only. Inside thumbturn is always free to allow exit.	

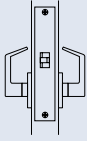
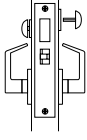
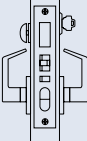
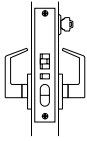
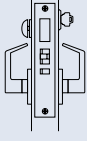
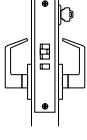
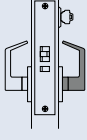
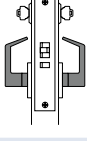
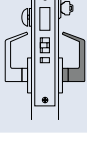

## DOOR LOCKS MORTISE LOCKSET FUNCTION GUIDE

FUNCTION	DESCRIPTION	INSIDE / OUTSIDE
10 PASSAGE	Latch bolt operated by lever from either side at all times.	
42 PRIVACY	Latch bolt operated by lever from either side except when thumb turn projects dead bolt and locks outside lever. Unlock by turning inside lever or by using outside emergency key, which retracts the deadbolt.	
45 ENTRANCE	Latch bolt operated by lever from either side except when outside lever is locked by push button rocker. Deadbolt projected by outside key and by thumb turn from inside. Deadbolt retracted by outside key. Rotating inside lever retracts both bolts (simultaneous retraction). Auxiliary latch deadlocks latch bolt.	
50 OFFICE	Latch bolt operated by lever from either side except when outside lever is locked by push button rocker or outside key. Latch bolt may be retracted by outside key or inside lever. Auxiliary latch deadlocks latch bolt.	
56 DORMITORY	Latch bolt operated by lever from either side or outside key. Deadbolt projected/retracted by key from outside and thumb turn from inside. Rotating inside lever retracts both bolts simultaneously. Extended deadbolt automatically deadlocks latch bolt.	
70 CLASSROOM	Latch bolt activated by lever from either side, except when outside lever is locked by outside key. Inside lever is always free to allow exit. Auxiliary latch deadlocks latch bolt.	
80 STOREROOM	Latch bolt operated by outside key or by inside lever. Outside lever is always locked. Auxiliary latch deadlocks latch bolt.	
82 INSTITUTION or UTILITY	Latch bolt retracted by key from either side. Lever on both sides always inoperative. Auxiliary latch deadlocks latch bolt.	
84 STOREROOM WITH DEADBOLT	Deadbolt projected and retracted by outside key or by inside lever or thumb turn. Inside lever retracts both bolts simultaneously. Extended deadbolt automatically deadlocks latch bolt.	
171 SINGLE DUMMY	Fixed, through-bolt mounted, inside or outside, single lever. *Surface mount available.	
172 BACK-TO-BACK DUMMY	Fixed, through-bolt mounted, inside and outside, paired levers.	





F1H



- Type** • Cylindrical lock
- Certifications**
  - Certified ANSI/BHMA A156.2, Series 4000, Grade 1
  - cULus listed, 3hr fire-rating
  - UL 10C Positive Pressure Rating
  - Meets ADA requirements
  - 10 Year limited warranty
- Door Thickness** • 1<sup>3</sup>/<sub>8</sub>–2<sup>1</sup>/<sub>4</sub>" (35–57 mm)
- Handing** • Non handed
- Backset**
  - 2<sup>3</sup>/<sub>4</sub>" (70 mm)
  - 2<sup>3</sup>/<sub>8</sub>" (60 mm) – available
- Spring Latch**
  - Stainless steel, 1/2" (12.7 mm) throw
  - Deadlatch, 3/4" (19 mm) throw – available
- Faceplate**
  - Mortise type, square corners
  - 1<sup>1</sup>/<sub>8</sub>x2<sup>1</sup>/<sub>4</sub>" (28.5x57 mm)
- Strike** • ASA Strike
- Trim**
  - Solid, pressure cast heavy duty lever
  - Lever secured by additional set screw
  - Brass rose
  - Rose diameter: 3<sup>1</sup>/<sub>2</sub>" (89 mm)

- Chassis**
  - Concealed mounting plate and screws
  - Fixed security posts
  - Lever clutch release
- Preparation**
  - Cross bore: 2<sup>1</sup>/<sub>8</sub>" (54 mm)
  - Edge bore: 1" (25.4 mm)
- Cylinder**
  - Solid brass, 6-pin
  - Schlage "C" keyway, 2 keys
  - Removable, rekeyable
  - Small format interchangeable core (SFIC) model – available\*

*Other keyways and keying options available, including CX5 high security. (\*) BEST® and CX5® cores sold separately.*
- Functions**

10 Passage	53 Entry
17 Dummy, single	70 Classroom
42 Privacy	80 Storeroom
- Lever Styles** C–Curved return\*, H–Standard return, S–Straight; no return\*  
 (\* ) Special order.
- Finish** 26D–Satin chrome  
*Other finishes available by special order.*

F1	H	53	26D	238
SERIES	STYLE	FUNCTION	FINISH	OPTION <sup>1</sup>

(1) OPTION: 238 2-3/8IN (60MM) BACKSET

## SELECTION GUIDE

SERIES	STYLE	FUNCTION <sup>2</sup>	FINISH <sup>2</sup>	/ CASE
F1	C <sup>1</sup> , H, S <sup>1</sup>	10 Passage	26D	6
F1	C <sup>1</sup> , H, S <sup>1</sup>	17 Dummy, single	26D	12
F1	C <sup>1</sup> , H, S <sup>1</sup>	42 Privacy	26D	6
F1	C <sup>1</sup> , H, S <sup>1</sup>	53 Entry ↔	26D	6
F1	C <sup>1</sup> , H, S <sup>1</sup>	70 Classroom ↔	26D	6
F1	C <sup>1</sup> , H, S <sup>1</sup>	80 Storeroom ↔	26D	6

(1) SPECIAL ORDER. (2) OTHER FINISHES AND FUNCTIONS AVAILABLE BY SPECIAL ORDER. MAY REQUIRE MINIMUM ORDER QUANTITIES AND/OR ADDITIONAL DELIVERY TIMES.

↔ KEYED FUNCTION; FULL KEYING SERVICES AVAILABLE.

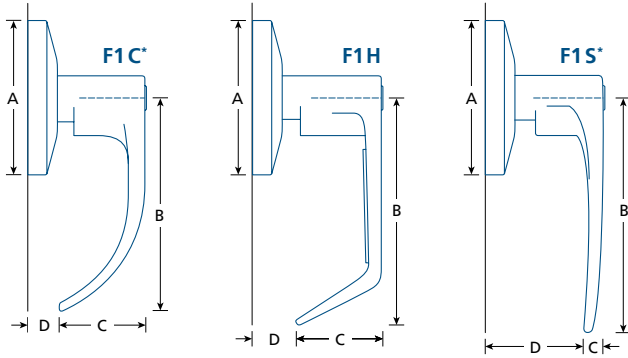

(\*) SPECIAL ORDER.

		A	B	C	D*
F1C	♿	3½ (89)	4½ (114)	2½ (63.3)	⅝ (16)
F1H	♿	3½ (89)	5 (127)	2½ (63.3)	½ (12.7)
F1S	♿	3½ (89)	5 (127)	¾ (19)	2⅜ (56)

IN (MM) (\*) DIMENSION MAY VARY DUE TO DOOR THICKNESS.

## PARTS & ACCESSORIES



### 9106

T-Strike, square corners:  
1½x2¾" (28.5x70 mm)

### 9106NH

T-Strike, no hole; square corners:  
1½x2¾" (28.5x70 mm)



### ASA-T

ASA strike with adjustable tab

### ASANH

ASA strike, no hole



### F1001

Passage latch: 2¾" (60 mm) backset,  
1½x2¼" (28.5x57 mm) faceplate



### F1010

Privacy latch: 2¾" (60 mm) backset,  
1½x2¼" (28.5x57 mm) faceplate



### F1DL234-34

Deadlatch: 2¾" (70 mm) backset, ¾" (19 mm)  
throw. 1½x2¼" (28.5x57 mm) faceplate  
*For use in double door or electric strike applications*





- Type** • Cylindrical lock
- Certifications**
- Certified ANSI/BHMA A156.2, Series 4000, Grade 1
  - cULus listed, 3hr fire-rating
  - UL 10C Positive Pressure Rating
  - Meets ADA requirements
  - 10 Year limited warranty
- Door Thickness**
- 1 $\frac{3}{8}$ –2" (35–51mm)
  - SFIC Models: 1 $\frac{9}{16}$ –2" (40–51mm)
- Handing** • Non handed
- Backset**
- 2 $\frac{3}{4}$ " (70 mm)
  - 2 $\frac{3}{8}$ " (60 mm) – available
  - 3 $\frac{3}{4}$ " (95 mm) – available
  - 5" (127 mm) – available
- Spring Latch**
- Stainless steel,  $\frac{1}{2}$ " (12.7 mm) throw
  - Deadlatch,  $\frac{3}{4}$ " (19 mm) throw – available
- Faceplate**
- Mortise type, square corners
  - 1 $\frac{1}{8}$ x2 $\frac{1}{4}$ " (28.5x57 mm)
- Strike** • ASA Strike
- Trim**
- Solid, pressure cast lever
  - Brass rose
  - Rose diameter: 3 $\frac{9}{16}$ " (90 mm)

- Chassis**
- Concealed mounting plate and screws
  - Fixed security posts
  - Lever clutch release
- Preparation**
- Cross bore: 2 $\frac{1}{8}$ " (54 mm)
  - Edge bore: 1" (25.4 mm)
- Cylinder**
- Solid brass, 6-pin
  - Schlage "C" keyway, 2 keys
  - Removable, rekeyable
  - Small format interchangeable core (SFIC) model – available\*
- Other keyways and keying options available, including CX5 high security. (\*) BEST® and CX5® cores sold separately.*
- Functions**
- |    |               |    |                    |
|----|---------------|----|--------------------|
| 10 | Passage       | 60 | Store              |
| 15 | Exit          | 70 | Classroom          |
| 17 | Dummy, single | 75 | Classroom security |
| 42 | Privacy       | 80 | Storeroom          |
| 53 | Entry         | 82 | Institution        |
- Lever Styles** C–Curved return, L–Standard return, S–Straight; no return
- Finish** C19–Matte black, C26D–Satin chrome
- Other finishes available by special order*



GX1	L	53	C26D
SERIES	STYLE	FUNCTION	FINISH

## SELECTION GUIDE

SERIES	STYLE	FUNCTION <sup>1</sup>	FINISH <sup>1</sup>	/CASE
GX1	C, L, S	10 Passage	C26D, C19 <sup>2</sup>	6
GX1	L	15 Exit	C26D	6
GX1	L	17 Dummy, single	C26D, C19 <sup>2</sup>	6
GX1	C, L, S	42 Privacy	C26D, C19 <sup>2</sup>	6
GX1	C, L, S	53 Entry ↔	C26D, C19 <sup>2</sup>	6
GX1	C, L, S	53IC Entry SFIC* ↔	C26D, C19 <sup>2</sup>	6
GX1	L	60IC Store SFIC* ↔	C26D	6
GX1	C, L, S	70 Classroom ↔	C26D, C19 <sup>2</sup>	6
GX1	C, L, S	70IC Classroom SFIC* ↔	C26D, C19 <sup>2</sup>	6
GX1	L	75 Classroom security ↔	C26D	6
GX1	L	75IC Classroom security SFIC* ↔	C26D	6
GX1	C, L, S	80 Storeroom ↔	C26D, C19 <sup>2</sup>	6
GX1	C, L, S	80IC Storeroom SFIC* ↔	C26D, C19 <sup>2</sup>	6
GX1	L	82 Institution ↔	C26D	6

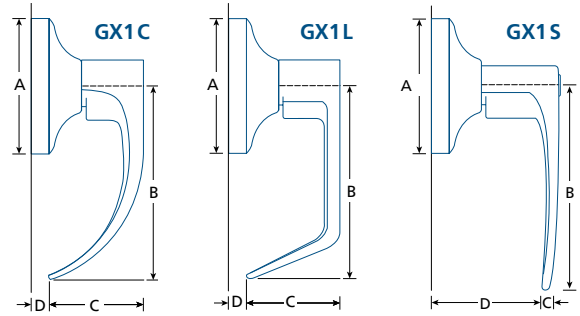
(1) OTHER FINISHES AND FUNCTIONS AVAILABLE, MINIMUM ORDER QUANTITIES AND/OR ADDITIONAL DELIVERY TIMES MAY BE REQUIRED. (2) GX1L ONLY (\*) ALL SFIC MODELS ARE LESS CORE  
 ↔ KEYED FUNCTION; FULL KEYING SERVICES AVAILABLE.



	A	B	C	D*
<b>GX1C</b> 	3 <sup>9</sup> / <sub>16</sub> (90)	5 (127)	2 <sup>1</sup> / <sub>2</sub> (63.3)	3 <sup>3</sup> / <sub>8</sub> (10)
<b>GX1L</b> 	3 <sup>9</sup> / <sub>16</sub> (90)	5 (127)	2 <sup>5</sup> / <sub>8</sub> (66.7)	3 <sup>3</sup> / <sub>8</sub> (10)
<b>GX1S</b> 	3 <sup>9</sup> / <sub>16</sub> (90)	5 (127)	7 <sup>7</sup> / <sub>8</sub> (22)	2 <sup>7</sup> / <sub>16</sub> (62)

IN (MM) (\*) DIMENSION MAY VARY DUE TO DOOR THICKNESS.

## PARTS & ACCESSORIES



**9106**  
T-Strike, square corners:  
1<sup>1</sup>/<sub>8</sub>x2<sup>3</sup>/<sub>4</sub>" (28.5x70 mm)



**9106NH**  
T-Strike, no hole; square corners:  
1<sup>1</sup>/<sub>8</sub>x2<sup>3</sup>/<sub>4</sub>" (28.5x70 mm)

**ASA-T**  
ASA strike with adjustable tab  
**ASANH**  
ASA strike, no hole



**CX5-9807**  
CX5 high security SFIC core, 7 pin, 0 bitting

**CBI-BF6KD-26D**  
BEST® F type SFIC core, 6 pin, keyed different  
**CBI-BF7KD-26D**  
BEST® F type SFIC core, 7 pin, keyed different



**GX1SL238**  
Passage latch: 2<sup>3</sup>/<sub>8</sub>" (60 mm) backset,  
1<sup>1</sup>/<sub>8</sub>x2<sup>1</sup>/<sub>4</sub>" (28.5x57 mm) faceplate



**GX1SL234**  
Passage latch: 2<sup>3</sup>/<sub>4</sub>" (70 mm) backset,  
1<sup>1</sup>/<sub>8</sub>x2<sup>1</sup>/<sub>4</sub>" (28.5x57 mm) faceplate

**GX1PL238**  
Privacy latch: 2<sup>3</sup>/<sub>8</sub>" (60 mm) backset,  
1<sup>1</sup>/<sub>8</sub>x2<sup>1</sup>/<sub>4</sub>" (28.5x57 mm) faceplate

**GX1PL234**  
Privacy latch: 2<sup>3</sup>/<sub>4</sub>" (70 mm) backset,  
1<sup>1</sup>/<sub>8</sub>x2<sup>1</sup>/<sub>4</sub>" (28.5x57 mm) faceplate

**GX1DL238**  
Deadlatch: 2<sup>3</sup>/<sub>8</sub>" (60) backset,  
1<sup>1</sup>/<sub>8</sub>x2<sup>1</sup>/<sub>4</sub>" (28.5x57 mm) faceplate

**GX1DL234**  
Deadlatch: 2<sup>3</sup>/<sub>4</sub>" (70 mm) backset,  
1<sup>1</sup>/<sub>8</sub>x2<sup>1</sup>/<sub>4</sub>" (28.5x57 mm) faceplate



**GX1DL234-34**  
Deadlatch: 2<sup>3</sup>/<sub>4</sub>" (70 mm) backset, 3<sup>4</sup>/<sub>8</sub>" (19 mm) throw,  
1<sup>1</sup>/<sub>8</sub>x2<sup>1</sup>/<sub>4</sub>" (28.5x57 mm) faceplate  
*For use in double door or electric strike applications*



**GX1LE334**  
Backset extension to 3<sup>3</sup>/<sub>4</sub>" (95 mm); use with  
2<sup>3</sup>/<sub>8</sub>" (60 mm) backset latch

**GX1LE500**  
Backset extension to 5" (127 mm); use with  
2<sup>3</sup>/<sub>4</sub>" (70 mm) backset latch





- Type** • Cylindrical lock, electrified
- Certifications**
- Certified ANSI/BHMA A156.2, Series 4000, Grade 1
  - cULus listed, 3hr fire-rating
  - UL 10C Positive Pressure Rating
  - Meets ADA requirements
  - 10 Year limited mechanical warranty
  - 1 Year limited electronic warranty
- Door Thickness**
- 1 $\frac{1}{8}$ –2" (35–51mm)
  - SFIC Models: 1 $\frac{9}{16}$ –2" (40–51mm)
- Handing** • Non handed
- Backset**
- 2 $\frac{3}{4}$ " (70mm)
  - 2 $\frac{3}{8}$ " (60mm) – available
  - 3 $\frac{3}{4}$ " (95mm) – available
  - 5" (127mm) – available
- Spring Latch**
- Stainless steel, 1/2" (12.7mm) throw
  - Deadlatch, 3/4" (19mm) throw – available
- Faceplate**
- Mortise type, square corners
  - 1 $\frac{1}{8}$ x2 $\frac{1}{4}$ " (28.5x57mm)
- Strike** • ASA Strike
- Trim**
- Solid, pressure cast lever
  - Brass rose
  - Rose diameter: 3 $\frac{9}{16}$ " (90mm)

- Chassis**
- Concealed mounting plate and screws
  - Fixed security posts
  - Lever clutch release
- Preparation**
- Cross bore: 2 $\frac{1}{8}$ " (54mm)
  - Edge bore: 1" (25.4mm)
- Cylinder**
- Solid brass, 6-pin
  - Schlage "C" keyway, 2 keys
  - Removable, rekeyable
  - Small format interchangeable core (SFIC) model – available\*
- Other keyways and keying options available, including CX5 high security. (\*) BEST® and CX5® cores sold separately.*
- Electrical Options**
- EL Fail Safe (Power fails = Unlocked)
  - EL-RX Fail Safe, Request to Exit
  - EU Fail Secure (Power fails = Locked)
  - EU-RX Fail Secure, Request to Exit
- Power** • Dual-voltage 12–24VDC
- Current** • 12VDC – 0.6A @ 20Ω
- Draw** • 24VDC – 0.3A @ 80Ω
- Operation** • -32° to 120°F (-0° to 49°C)
- Temperature** *Temperature tolerance can vary due to weather.*
- Function** 80 Storeroom
- Lever Styles** C–Curved return, L–Standard return, S–Straight; no return
- Finish** C19–Matte black; C26D–Satin chrome  
*Other finishes available by special order*

GX1	L	80	C26D	–	EL	–	RX
SERIES	STYLE	FUNCTION	FINISH		OPTION <sup>1</sup>		OPTION <sup>2</sup>

(1) EL: FAIL SAFE (2) RX: WITH REQUEST TO EXIT

## SELECTION GUIDE

SERIES	STYLE	FUNCTION <sup>1</sup>	FINISH <sup>1</sup>	/CASE
GX1	C, L, S	80 Storeroom	C19, C26D	6

(1) SFIC AND OTHER FUNCTIONS AND FINISHES AVAILABLE, MINIMUM ORDER QUANTITIES AND/OR ADDITIONAL DELIVERY TIMES MAY BE REQUIRED.  
 KEYED FUNCTION; FULL KEYING SERVICES AVAILABLE.

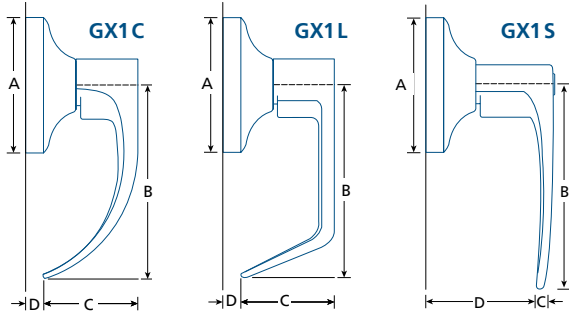

	A	B	C	D*
<b>GX1C</b>	3 <sup>9</sup> / <sub>16</sub> (90)	5 (127)	2 <sup>1</sup> / <sub>2</sub> (63.3)	3 <sup>3</sup> / <sub>8</sub> (10)
<b>GX1L</b>	3 <sup>9</sup> / <sub>16</sub> (90)	5 (127)	2 <sup>5</sup> / <sub>8</sub> (66.7)	3 <sup>3</sup> / <sub>8</sub> (10)
<b>GX1S</b>	3 <sup>9</sup> / <sub>16</sub> (90)	5 (127)	7 <sup>7</sup> / <sub>8</sub> (22)	2 <sup>7</sup> / <sub>16</sub> (62)

IN (MM) (\*) DIMENSION MAY VARY DUE TO DOOR THICKNESS.

## PARTS & ACCESSORIES



**9106**  
T-Strike, square corners:  
1<sup>1</sup>/<sub>8</sub>x2<sup>3</sup>/<sub>4</sub>" (28.5x70 mm)

**9106NH**  
T-Strike, no hole; square corners:  
1<sup>1</sup>/<sub>8</sub>x2<sup>3</sup>/<sub>4</sub>" (28.5x70 mm)



**ASA-T**  
ASA strike with adjustable tab

**ASANH**  
ASA strike, no hole



**CX5-9807**  
CX5 high security SFIC core, 7 pin, 0 bitted

**CBI-BF6KD-26D**  
BEST@ F type SFIC core, 6 pin, keyed different

**CBI-BF7KD-26D**  
BEST@ F type SFIC core, 7 pin, keyed different



**JC-603QC-BB1079-ETW04/08**  
Wired power transfer hinge with 4 or 8, 28 AWG wires (MAX. 24V, 4A) with molex connector. Must be installed with ball bearing hinges of the same size (4<sup>1</sup>/<sub>2</sub>x4). Not rated for use on fire doors. See page 04.620 for more details.



**GX1SL238**  
Passage latch: 2<sup>3</sup>/<sub>8</sub>" (60 mm) backset,  
1<sup>1</sup>/<sub>8</sub>x2<sup>1</sup>/<sub>4</sub>" (28.5x57 mm) faceplate

**GX1SL234**  
Passage latch: 2<sup>3</sup>/<sub>4</sub>" (70 mm) backset,  
1<sup>1</sup>/<sub>8</sub>x2<sup>1</sup>/<sub>4</sub>" (28.5x57 mm) faceplate

**GX1PL238**  
Privacy latch: 2<sup>3</sup>/<sub>8</sub>" (60 mm) backset,  
1<sup>1</sup>/<sub>8</sub>x2<sup>1</sup>/<sub>4</sub>" (28.5x57 mm) faceplate

**GX1PL234**  
Privacy latch: 2<sup>3</sup>/<sub>4</sub>" (70 mm) backset,  
1<sup>1</sup>/<sub>8</sub>x2<sup>1</sup>/<sub>4</sub>" (28.5x57 mm) faceplate



**GX1DL238**  
Deadlatch: 2<sup>3</sup>/<sub>8</sub>" (60) backset,  
1<sup>1</sup>/<sub>8</sub>x2<sup>1</sup>/<sub>4</sub>" (28.5x57 mm) faceplate

**GX1DL234**  
Deadlatch: 2<sup>3</sup>/<sub>4</sub>" (70 mm) backset,  
1<sup>1</sup>/<sub>8</sub>x2<sup>1</sup>/<sub>4</sub>" (28.5x57 mm) faceplate



**GX1DL234-34**  
Deadlatch: 2<sup>3</sup>/<sub>4</sub>" (70 mm) backset, 3<sup>4</sup>/<sub>4</sub>" (19 mm) throw, 1<sup>1</sup>/<sub>8</sub>x2<sup>1</sup>/<sub>4</sub>" (28.5x57 mm) faceplate  
For use in double door or electric strike applications



**GX1LE334**  
Backset extension to 3<sup>3</sup>/<sub>4</sub>" (95 mm); use with 2<sup>3</sup>/<sub>8</sub>" (60 mm) backset latch

**GX1LE500**  
Backset extension to 5" (127 mm); use with 2<sup>3</sup>/<sub>4</sub>" (70 mm) backset latch





**BHMA**  
CERTIFIED

**G2**

**UL**  
LISTED  
US

**3H**

**ADA**

**10**  
YEAR

FC

**NEW**  
FL

FS

- Type** • Cylindrical lock
- Certifications**
  - Certified ANSI/BHMA A156.2, Series 4000, Grade 2
  - cULus listed, 3hr fire-rating
  - UL 10C Positive Pressure Rating
  - Meets ADA requirements
  - 10 Year limited warranty
- Door Thickness** • 1<sup>3</sup>/<sub>8</sub> – 1<sup>3</sup>/<sub>4</sub>" (35 – 44.5 mm)
- Handing** • Non handed
- Backset**
  - 2<sup>3</sup>/<sub>4</sub>" (70 mm)
  - 2<sup>3</sup>/<sub>8</sub>" (60 mm) – available
  - 3<sup>3</sup>/<sub>4</sub>" (95 mm) – available
  - 5" (127 mm) – available
- Spring Latch** • Stainless steel, 1/2" (12.7 mm) throw
- Faceplate**
  - Mortise type, square corners
  - 1<sup>1</sup>/<sub>8</sub> x 2<sup>1</sup>/<sub>4</sub>" (28.5 x 57 mm)
- Strike** • ASA Strike
- Trim**
  - Solid, pressure cast lever
  - Brass rose
  - Rose diameter: 3<sup>5</sup>/<sub>16</sub>" (84.5 mm)

- Chassis**
  - Concealed mounting plate and screws
  - Removable security posts
  - Lever clutch release – option\*

(\* For keyed functions, may require special order)

- Preparation**
  - Cross bore: 2<sup>1</sup>/<sub>8</sub>" (54 mm)
  - Edge bore: 1" (25.4 mm)

- Cylinder**
  - Solid brass, 6-pin
  - Schlage "C" keyway, 2 keys
  - Removable, rekeyable

*Other keyways and keying options available, including CX5 high security*

<b>Functions</b>	10 Passage	53 Entry*
	15 Exit	60 Store
	17 Dummy, single	70 Classroom
	42 Privacy	80 Storeroom*
	51 Office	82 Institution

(\* Lever clutch release available (-0))

- Lever Styles** C–Curved return, H–Standard return, L–Linear; no return, S–Straight; no return

- Finish** C19–Matte black, C26D–Satin chrome, C3–Polished brass

*Other finishes available by special order*

<b>F</b>	<b>H</b>	<b>53</b>	<b>C26D</b>	<b>-</b>	<b>O</b>
SERIES	STYLE	FUNCTION	FINISH		OPTION <sup>1</sup>

(1) OPTIONS: 238 2-3/8IN (60MM) BACKSET O LEVER CLUTCH RELEASE (53 & 80 ONLY)





## SELECTION GUIDE

SERIES	STYLE	FUNCTION <sup>1</sup>	FINISH <sup>1</sup>	/ CASE
F	C, H, L, S	10 Passage	C26D, C3, C19 <sup>2</sup>	12
F	C, H, S	15 Exit	C26D	12
F	C, H, L, S	17 Dummy, single	C26D, C3, C19 <sup>2</sup>	40
F	C, H, L, S	42 Privacy	C26D, C3, C19 <sup>2</sup>	12
F	C, H, S	51 Office ↔	C26D	12
F	C, H, L, S	53 Entry ↔	C26D, C3, C19 <sup>2</sup>	12
F	C, H	53-O Entry, with clutch release ↔	C26D	12
F	C, H, S	60 Store ↔	C26D	12
F	C, H, L, S	70 Classroom ↔	C26D, C3, C19 <sup>2</sup>	12
F	C, H, L, S	80 Storeroom ↔	C26D, C3, C19 <sup>2</sup>	12
F	C, H	80-O Storeroom, with clutch release ↔	C26D	12
F	C, H, S	82 Institution / utility ↔	C26D	12

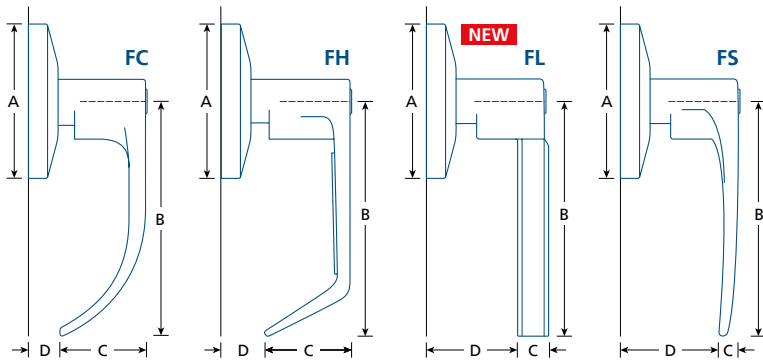
(1) OTHER FINISHES AND FUNCTIONS AVAILABLE, MINIMUM ORDER QUANTITIES AND/OR ADDITIONAL DELIVERY TIMES MAY BE REQUIRED.

↔ KEYED FUNCTION; FULL KEYING SERVICES AVAILABLE. (1) NOTE: IN-STOCK FS LEVERS ARE ONLY AVAILABLE IN C26D. (2) FH, FL ONLY.



	A	B	C	D*
<b>FC</b> 	3 5/16 (84.5)	4 1/2 (114)	1 7/8 (48)	1/2 (12.7)
<b>FH</b> 	3 5/16 (84.5)	4 1/2 (114)	1 7/8 (48)	1/2 (12.7)
<b>FL</b> 	3 5/16 (84.5)	4 11/16 (119)	3/4 (19)	1 27/32 (46.8)
<b>FS</b> 	3 5/16 (84.5)	4 11/16 (119)	9/16 (14)	1 27/32 (46.8)

IN (MM) (\*) DIMENSION MAY VARY DUE TO DOOR THICKNESS.

## PARTS & ACCESSORIES



### 9106

T-Strike, square corners:  
1 1/8 x 2 3/4" (28.5 x 70 mm)

### 9106NH

T-Strike, no hole; square corners:  
1 1/8 x 2 3/4" (28.5 x 70 mm)



### ASA-T

ASA strike with adjustable tab

### ASANH

ASA strike, no hole



### TL013

Backset extension to 3 3/4" (95 mm);  
Use with 2 3/8" (60 mm) backset latch

### TL014

Backset extension to 5" (127 mm);  
Use with 2 3/4" (70 mm) backset latch



### FH001

Passage latch: 2 3/8" (60 mm) backset,  
1 1/8 x 2 1/4" (28.5 x 57 mm) faceplate

### FH003

Passage latch: 2 3/4" (70 mm) backset,  
1 1/8 x 2 1/4" (28.5 x 57 mm) faceplate

### FH010

Privacy latch: 2 3/8" (60 mm) backset,  
1 1/8 x 2 1/4" (28.5 x 57 mm) faceplate

### FH002

Privacy latch: 2 3/4" (70 mm) backset,  
1 1/8 x 2 1/4" (28.5 x 57 mm) faceplate



### FH005

Deadlatch: 2 3/8" (60 mm) backset,  
1 1/8 x 2 1/4" (28.5 x 57 mm) faceplate

### FH004

Deadlatch: 2 3/4" (70 mm) backset,  
1 1/8 x 2 1/4" (28.5 x 57 mm) faceplate





- Type** • Cylindrical lock
- Certifications**
  - Conforms to ANSI/BHMA A156.2, Series 4000, Grade 2
  - cULus listed, 3hr fire-rating
  - UL 10C Positive Pressure Rating
  - Meets ADA requirements
  - 10 Year limited warranty
- Door Thickness** • 1 $\frac{3}{8}$ –2" (35–51 mm)
- Handing** • Non handed
- Backset**
  - 2 $\frac{3}{4}$ " (70 mm)
  - 2 $\frac{5}{8}$ " (60 mm) – available
  - 3 $\frac{3}{4}$ " (95 mm) – available
  - 5" (127 mm) – available
- Spring Latch**
  - Stainless steel,  $\frac{1}{2}$ " (12.7 mm) throw
  - Deadlatch,  $\frac{3}{4}$ " (19 mm) throw – available
- Faceplate**
  - Mortise type, square corners
  - 1 $\frac{1}{8}$ x2 $\frac{1}{4}$ " (28.5x57 mm)
- Strike** • ASA Strike
- Trim**
  - Solid, pressure cast lever
  - Brass rose
  - Rose diameter: 3 $\frac{5}{16}$ " (84.5 mm)

- Chassis**
  - Concealed mounting plate and screws
  - Removable security posts
  - Lever clutch release – option\*

*(\*): For keyed functions, may require special order*

- Preparation**
  - Cross bore: 2 $\frac{1}{8}$ " (54 mm)
  - Edge bore: 1" (25.4 mm)

- Cylinder**
  - Solid brass, 6-pin
  - Schlage "C" keyway, 2 keys
  - Removable, rekeyable

*Other keyways and keying options available, including CX5 high security*

- |                  |                         |                     |
|------------------|-------------------------|---------------------|
| <b>Functions</b> | <b>00</b> Dummy, single | <b>53</b> Entry     |
|                  | <b>10</b> Passage       | <b>70</b> Classroom |
|                  | <b>40</b> Privacy       | <b>80</b> Storeroom |

- Lever Styles** F–The Flat; H–Standard return

- Finish** 15–Satin nickel, 19–Matte black, 26D–Satin chrome

*Other finishes available by special order*

T2	F	53	–	26D	–	C
SERIES	STYLE	FUNCTION		FINISH		OPTION <sup>1</sup>

(1) C: CLUTCH RELEASE.

## SELECTION GUIDE

SERIES	STYLE	FUNCTION <sup>1</sup>	FINISH <sup>1</sup>	/ CASE
T2	F, H	00 Dummy, single	15 <sup>2</sup> , 19 <sup>2</sup> , 26D	12
T2	F, H	10 Passage	15 <sup>2</sup> , 19 <sup>2</sup> , 26D	6
T2	F, H	40 Privacy, push button thumb-turn	15 <sup>2</sup> , 19 <sup>2</sup> , 26D	6
T2	F, H	53 Entry ↔	15 <sup>2</sup> , 19 <sup>2</sup> , 26D	6
T2	H	53-C Entry, with clutch release ↔	26D	6
T2	F, H	70 Classroom ↔	15 <sup>2</sup> , 19 <sup>2</sup> , 26D	6
T2	H	70-C Classroom, with clutch release ↔	26D	6
T2	F, H	80 Storeroom ↔	15 <sup>2</sup> , 19 <sup>2</sup> , 26D	6
T2	H	80-C Storeroom, with clutch release ↔	26D	6

(1) OTHER FINISHES AND FUNCTIONS AVAILABLE, MINIMUM ORDER QUANTITIES AND/OR ADDITIONAL DELIVERY TIMES MAY BE REQUIRED. (2) AVAILABLE FOR T2H BY SPECIAL ORDER.

↔ KEYED FUNCTION; FULL KEYING SERVICES AVAILABLE.

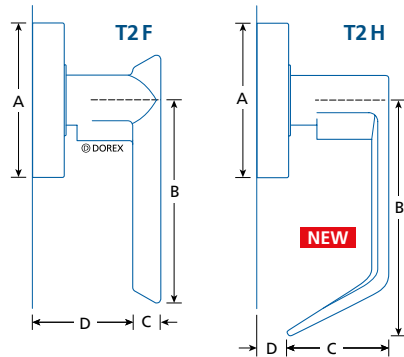

		A	B	C	D*
T2F	Ⓛ	3 <sup>5</sup> / <sub>16</sub> (84.5)	4 <sup>7</sup> / <sub>32</sub> (107)	<sup>5</sup> / <sub>8</sub> (16.7)	2 (51.3)
T2H	Ⓛ	3 <sup>5</sup> / <sub>16</sub> (84.5)	4 <sup>1</sup> / <sub>2</sub> (114)	2 <sup>5</sup> / <sub>16</sub> (58.7)	<sup>3</sup> / <sub>8</sub> (9.5)

IN (MM)

(\* DIMENSION MAY VARY DUE TO DOOR THICKNESS.

## PARTS & ACCESSORIES



### 9106

T-Strike, square corners:  
1 <sup>1</sup>/<sub>8</sub> x 2 <sup>3</sup>/<sub>4</sub> " (28.5 x 70 mm)

### 9106NH

T-Strike, no hole; square corners:  
1 <sup>1</sup>/<sub>8</sub> x 2 <sup>3</sup>/<sub>4</sub> " (28.5 x 70 mm)



### ASA-T

ASA strike with adjustable tab

### ASANH

ASA strike, no hole



### TL020

Plastic spacer for latches with 1 x 2 <sup>1</sup>/<sub>4</sub> " (25.4 x 57 mm) faceplate to fit preparations for 1 <sup>1</sup>/<sub>8</sub> x 2 <sup>1</sup>/<sub>4</sub> " (28.5 x 57 mm) faceplates



### TL013

Backset extension to 3 <sup>3</sup>/<sub>4</sub> " (95 mm);  
Use with 2 <sup>3</sup>/<sub>8</sub> " (60 mm) backset latch

### TL014

Backset extension to 5 " (127 mm);  
Use with 2 <sup>3</sup>/<sub>4</sub> " (70 mm) backset latch



### TL001

Passage latch: 2 <sup>3</sup>/<sub>8</sub> " (60 mm) backset,  
1 x 2 <sup>1</sup>/<sub>4</sub> " (25.4 x 57 mm) faceplate

### TL003

Passage latch: 2 <sup>3</sup>/<sub>4</sub> " (70 mm) backset,  
1 <sup>1</sup>/<sub>8</sub> x 2 <sup>1</sup>/<sub>4</sub> " (28.5 x 57 mm) faceplate

### TL010

Privacy latch: 2 <sup>3</sup>/<sub>8</sub> " (60 mm) backset,  
1 x 2 <sup>1</sup>/<sub>4</sub> " (25.4 x 57 mm) faceplate

### TL002

Privacy latch: 2 <sup>3</sup>/<sub>4</sub> " (70 mm) backset,  
1 <sup>1</sup>/<sub>8</sub> x 2 <sup>1</sup>/<sub>4</sub> " (28.5 x 57 mm) faceplate



### TL005

Deadlatch: 2 <sup>3</sup>/<sub>8</sub> " (60 mm) backset,  
1 x 2 <sup>1</sup>/<sub>4</sub> " (25.4 x 57 mm) faceplate

### TL004

Deadlatch: 2 <sup>3</sup>/<sub>4</sub> " (70 mm) backset,  
1 <sup>1</sup>/<sub>8</sub> x 2 <sup>1</sup>/<sub>4</sub> " (28.5 x 57 mm) faceplate

### TL006

Deadlatch: 5 " (127 mm) backset,  
1 <sup>1</sup>/<sub>8</sub> x 2 <sup>1</sup>/<sub>4</sub> " (28.5 x 57 mm) faceplate



### GX1DL234-34

Deadlatch: 2 <sup>3</sup>/<sub>4</sub> " (70 mm) backset, <sup>3</sup>/<sub>4</sub> " (19 mm) throw, 1 <sup>1</sup>/<sub>8</sub> x 2 <sup>1</sup>/<sub>4</sub> " (28.5 x 57 mm) faceplate  
*For use in double door or electric strike applications*





- Type** • Cylindrical lock
- Certifications**
  - Conforms to ANSHI/BHMA A156.2, Series 4000, Grade 2
  - cULus listed, 3hr fire-rating
  - UL 10C Positive Pressure Rating
  - Meets ADA requirements
  - 1 Year limited warranty
- Door Thickness**
  - 1 $\frac{3}{8}$  – 1 $\frac{3}{4}$ " (35–45 mm)
  - Indicator model: 1 $\frac{3}{4}$ " (45 mm)
- Handing** • Non handed
- Backset**
  - 2 $\frac{3}{4}$ " (70 mm)
  - 2 $\frac{3}{8}$ " (60 mm) – available\*

(\*) Sold separately
- Spring Latch** • Stainless steel, 1/2" (12.7 mm) throw
- Faceplate**
  - Mortise type, square corners
  - 1 $\frac{1}{8}$  x 2 $\frac{1}{4}$ " (28.5 x 57 mm)
- Strike** • ASA Strike

- Trim**
  - Solid, pressure cast heavy duty lever
  - Brass rose
  - Rose diameter: 3 $\frac{3}{8}$ " (85.7 mm)
- Chassis**
  - Concealed mounting plate and screws
  - Removable security posts
- Preparation**
  - Cross bore: 2 $\frac{1}{8}$ " (54 mm)
  - Edge bore: 1" (25.4 mm)
- Cylinder**
  - Solid brass, 6-pin
  - Schlage "C" keyway, 2 keys
  - Removable, rekeyable

*Other keyways and keying options available, including CX5 high security.*
- Functions**

10 Passage	53 Entry
17 Dummy, single	53I Entry w/ indicator
42 Privacy	70 Classroom
42I Privacy w/ indicator	80 Storeroom
- Lever Styles** H–Standard return
- Finish** 26D–Satin chrome

RW	H	53	-	C26D
SERIES	STYLE	FUNCTION		FINISH

(1) OPTION:

## SELECTION GUIDE

SERIES	STYLE	FUNCTION <sup>1</sup>	FINISH	/ CASE
RW	H	10 Passage	26D	10
RW	H	17 Dummy, single	26D	20
RW	H	42 Privacy	26D	10
RW	H	42I Privacy, with indicator	26D	10
RW	H	53 Entry ↔	26D	10
RW	H	53I Entry, with indicator ↔	26D	10
RW	H	70 Classroom ↔	26D	10
RW	H	80 Storeroom ↔	26D	10

(1) OTHER FUNCTIONS AVAILABLE, MINIMUM ORDER QUANTITIES AND/OR ADDITIONAL DELIVERY TIMES MAY BE REQUIRED.

↔ KEYED FUNCTION; FULL KEYING SERVICES AVAILABLE.

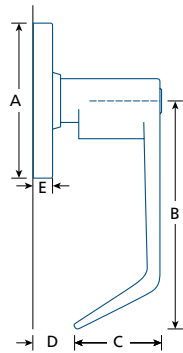

		A	B	C	D	E
RW	Ⓛ	3 <sup>3</sup> / <sub>8</sub> (85.7)	4 <sup>3</sup> / <sub>4</sub> (120)	2 <sup>1</sup> / <sub>8</sub> (54)	7 <sup>1</sup> / <sub>16</sub> * (11)	3 <sup>3</sup> / <sub>8</sub> (9.5)
RW Indicator	Ⓛ	3 <sup>3</sup> / <sub>8</sub> (85.7)	4 <sup>3</sup> / <sub>4</sub> (120)	2 <sup>1</sup> / <sub>8</sub> (54)	7 <sup>1</sup> / <sub>16</sub> (11)	9 <sup>1</sup> / <sub>16</sub> (14.3)

IN (MM) (\*) DIMENSION MAY VARY DUE TO DOOR THICKNESS.

## PARTS & ACCESSORIES



**9106**  
T-Strike, square corners:  
1<sup>1</sup>/<sub>8</sub>x 2<sup>3</sup>/<sub>4</sub>" (28.5x 70 mm)



**ASA**  
ASA strike



**CWAL-01**  
Passage latch: 2<sup>3</sup>/<sub>8</sub>" (60 mm) backset,  
1<sup>1</sup>/<sub>8</sub>x 2<sup>1</sup>/<sub>4</sub>" (28.5x 57 mm) faceplate



**CWAL-05**  
Deadlatch: 2<sup>3</sup>/<sub>8</sub>" (60 mm) backset,  
1<sup>1</sup>/<sub>8</sub>x 2<sup>1</sup>/<sub>4</sub>" (28.5x 57 mm) faceplate





- Type** • Cylindrical lock
- Certifications**
  - Conforms to ANSHI/BHMA A156.2, Series 4000, Grade 2
  - cULus listed, 3hr fire-rating
  - UL 10C Positive Pressure Rating
  - Meets ADA requirements
  - 1 Year limited warranty
- Door Thickness** • 1<sup>3</sup>/<sub>8</sub> – 1<sup>3</sup>/<sub>4</sub>" (35–45 mm)
- Handing** • Non handed
- Backset**
  - 2<sup>3</sup>/<sub>4</sub>" (70 mm)
  - 2<sup>3</sup>/<sub>8</sub>" (60 mm) – available
- Spring Latch** • Stainless steel, 1/2" (12.7 mm) throw
- Faceplate**
  - Mortise type, square corners
  - 1<sup>1</sup>/<sub>8</sub> x 2<sup>1</sup>/<sub>4</sub>" (28.5 x 57 mm)
- Strike** • ASA Strike
- Trim**
  - Solid, pressure cast heavy duty lever
  - Brass rose
  - Rose diameter: 3" (76 mm)

- Chassis** • Concealed mounting plate and screws
- Preparation**
  - Cross bore: 2<sup>1</sup>/<sub>8</sub>" (54 mm)
  - Edge bore: 1" (25.4 mm)
- Cylinder**
  - Solid brass, 6-pin
  - Schlage "C" keyway, 2 keys
  - Removable, rekeyable

*Other keyways and keying options available, including CX5 high security.*
- Functions**

10 Passage	53 Entry
17 Dummy, single	70 Classroom
42 Privacy	80 Storeroom
- Lever Styles** H–Standard return
- Finish** 26D–Satin chrome

CW	H	53	-	C26D	238
SERIES	STYLE	FUNCTION		FINISH	OPTION <sup>1</sup>

(1) OPTION: 238 2-3/8IN (60MM) BACKSET

## SELECTION GUIDE

SERIES	STYLE	FUNCTION <sup>1</sup>	FINISH	/ CASE
CW	H	10 Passage	26D	10
CW	H	17 Dummy, single	26D	20
CW	H	42 Privacy	26D	10
CW	H	53 Entry 	26D	10
CW	H	70 Classroom 	26D	10
CW	H	80 Storeroom 	26D	10

(1) OTHER FUNCTIONS AVAILABLE, MINIMUM ORDER QUANTITIES AND/OR ADDITIONAL DELIVERY TIMES MAY BE REQUIRED.

 KEYED FUNCTION; FULL KEYING SERVICES AVAILABLE.

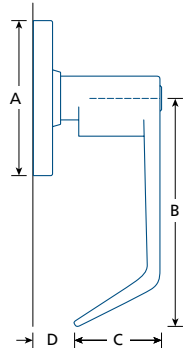

	A	B	C	D*
<b>CWH</b> 	3 (76)	4 <sup>3</sup> / <sub>4</sub> (120)	2 <sup>1</sup> / <sub>16</sub> (52)	1/2 (12.7)

IN (MM) (\*) DIMENSION MAY VARY DUE TO DOOR THICKNESS.

## PARTS & ACCESSORIES



**9106**  
T-Strike, square corners:  
1<sup>1</sup>/<sub>8</sub>x 2<sup>3</sup>/<sub>4</sub>" (28.5x 70 mm)



**ASA**  
ASA strike



**CWAL-01**  
Passage latch: 2<sup>3</sup>/<sub>8</sub>" (60 mm) backset,  
1<sup>1</sup>/<sub>8</sub>x 2<sup>1</sup>/<sub>4</sub>" (28.5x 57 mm) faceplate



**CWAL-05**  
Deadlatch: 2<sup>3</sup>/<sub>8</sub>" (60 mm) backset,  
1<sup>1</sup>/<sub>8</sub>x 2<sup>1</sup>/<sub>4</sub>" (28.5x 57 mm) faceplate





- Type** • Cylindrical lock
- Certifications**
  - Conforms to ANSI/BHMA A156.2, Series 4000, Grade 2
  - cULus listed, 3hr fire-rating
  - UL 10C Positive Pressure Rating
  - Meets ADA requirements
  - 1 Year limited warranty
- Door Thickness** • 1 $\frac{3}{8}$  – 1 $\frac{3}{4}$ " (35–44.5 mm)
- Handing** • Non handed
- Backset**
  - 2 $\frac{3}{4}$ " (70 mm)
  - 2 $\frac{3}{8}$ " (60 mm) – available
  - 3 $\frac{3}{4}$ " (95 mm) – available
  - 5" (127 mm) – available
- Spring Latch** • Stainless steel, 1/2" (12.7 mm) throw
- Faceplate**
  - Mortise type, square corners
  - 1 $\frac{1}{8}$  x 2 $\frac{1}{4}$ " (28.5 x 57 mm)
  - 2 $\frac{3}{8}$ " (60 mm) backset: 1 x 2 $\frac{1}{4}$ " (25.4 x 57 mm)
- Strike** • ASA Strike
- Trim**
  - Solid, pressure cast lever
  - Brass rose
  - Rose diameter: 3" (76 mm)

- Chassis**
  - Concealed mounting plate and screws
  - Removable security posts
- Preparation**
  - Cross bore: 2 $\frac{1}{8}$ " (54 mm)
  - Edge bore: 1" (25.4 mm)
- Cylinder**
  - Solid brass, 6-pin
  - Schlage "C" keyway, 2 keys
  - Removable, rekeyable

*Other keyways and keying options available, including CX5 high security*
- Functions**

10 Passage	60 Store
15 Exit	70 Classroom
17 Dummy, single	79 Institution exit
42 Privacy	80 Storeroom
52 Entry <sup>1</sup>	82 Institution
53 Entry	

*(1) See selection guide for details*

**Lever Styles** M–Standard, return

**Finish** C15–Satin nickel  
C3–Polished brass

*Other finishes available by special order*

E	M	53	C15	238
SERIES	STYLE	FUNCTION	FINISH	OPTION <sup>1</sup>

(1) OPTIONS: 238 2-3/8IN (60MM) BACKSET

## SELECTION GUIDE

SERIES	FUNCTION <sup>1</sup>	FINISH <sup>1</sup>	/ CASE
EM	10 Passage	C15, C3	10
EM	15 Exit	C15	10
EM	17 Dummy, single	C15, C3	20
EM	42 Privacy	C15, C3	10
EM	52 Entry, locking slotted push button ↔	C15, C3	10
EM	53 Entry, locking thumb-turn push button ↔	C15, C3	10
EM	53LC Entry, less core ↔	C15, C3	10
EM	60 Store ↔	C15	10
EM	70 Classroom ↔	C15, C3	10
EM	79 Institution exit ↔	C15	10
EM	80 Storeroom ↔	C15, C3	10
EM	82 Institution ↔	C15	10

(1) OTHER FINISHES AND FUNCTIONS AVAILABLE, MINIMUM ORDER QUANTITIES AND/OR ADDITIONAL DELIVERY TIMES MAY BE REQUIRED

↔ KEYED FUNCTION; FULL KEYING SERVICES AVAILABLE

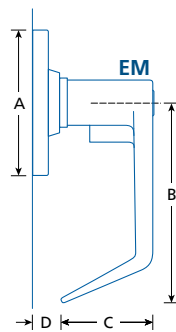

	A	B	C	D*
EM	3 (76)	4 (102)	17/8 (48)	7/16 (11)

IN (MM) (\*) DIMENSION MAY VARY DUE TO DOOR THICKNESS.

## PARTS & ACCESSORIES



**9106**  
T-Strike, square corners:  
1 1/8 x 2 3/4" (28.5 x 70 mm)



**9106NH**  
T-Strike, no hole; square corners:  
1 1/8 x 2 3/4" (28.5 x 70 mm)

**ASA-T**  
ASA Strike, adjustable tab; square corners

**ASANH**  
ASA T-Strike, no hole; square corners



**TL020**  
Plastic spacer for latches with 1 x 2 1/4" (25.4 x 57 mm) faceplate to fit preparations for 1 1/8 x 2 1/4" (28.5 x 57 mm) faceplates



**TL013**  
Backset extension to 3 3/4" (95 mm);  
Use with 2 3/8" (60 mm) backset latch

**TL014**  
Backset extension to 5" (127 mm);  
Use with 2 3/4" (70 mm) backset latch



**TL001**  
Passage latch: 2 3/8" (60 mm) backset,  
1 x 2 1/4" (25.4 x 57 mm) faceplate

**TL003**  
Passage latch: 2 3/4" (70 mm) backset,  
1 1/8 x 2 1/4" (28.5 x 57 mm) faceplate

**TL010**  
Privacy latch: 2 3/8" (60 mm) backset,  
1 x 2 1/4" (25.4 x 57 mm) faceplate

**TL002**  
Privacy latch: 2 3/4" (70 mm) backset,  
1 1/8 x 2 1/4" (28.5 x 57 mm) faceplate



**TL005**  
Deadlatch 2 3/8" (60 mm) backset  
1 x 2 1/4" (25.4 x 57 mm) faceplate

**TL004**  
Deadlatch: 2 3/4" (70 mm) backset,  
1 1/8 x 2 1/4" (28.5 x 57 mm) faceplate

**TL006**  
Deadlatch: 5" (127 mm) backset,  
1 1/8 x 2 1/4" (28.5 x 57 mm) faceplate





- Type** • Cylindrical lock
- Certifications**
  - Certified ANSI/BHMA A156.2, Series 4000, Grade 1
  - cULus listed, 3hr fire-rating
  - UL 10C Positive Pressure Rating
  - 10 Year limited warranty
- Door Thickness**
  - 1<sup>3</sup>/<sub>8</sub>–2" (35–51 mm)
  - SFIC models: 1<sup>9</sup>/<sub>16</sub>–2" (40–51 mm)
- Handing** • Non handed
- Backset**
  - 2<sup>3</sup>/<sub>4</sub>" (70 mm)
  - 2<sup>3</sup>/<sub>8</sub>" (60 mm) – available
  - 3<sup>3</sup>/<sub>4</sub>" (95 mm) – available
  - 5" (127 mm) – available
- Spring Latch**
  - Stainless steel, 1/2" (12.7 mm) throw
  - Deadlatch, 3/4" (19 mm) throw – available
- Faceplate**
  - Mortise type, square corners
  - 1<sup>1</sup>/<sub>8</sub> x 2<sup>1</sup>/<sub>4</sub>" (28.5 x 57 mm)
- Strike** • ASA Strike
- Trim**
  - Stainless steel knob
  - Stainless steel rose
  - Rose diameter: 2<sup>15</sup>/<sub>16</sub>" (74.6 mm)

- Chassis**
  - Concealed mounting plate and screws
  - Removable security posts
- Preparation**
  - Cross bore: 2<sup>1</sup>/<sub>8</sub>" (54 mm)
  - Edge bore: 1" (25.4 mm)
- Cylinder**
  - Solid brass, 6-pin
  - Schlage "C" keyway, 2 keys
  - Removable, rekeyable
  - Small format interchangeable core (SFIC) model – available\*

*Other keyways and keying options available, including CX5 high security. (\*) BEST® and CX5® cores sold separately.*

<b>Functions</b>	<b>10</b> Passage	<b>70</b> Classroom
	<b>42</b> Privacy	<b>80</b> Storeroom
	<b>53</b> Entry	
	<b>60</b> Store	

**Finish** C32D–Stainless steel

*Other finishes available by special order*

<b>GX1B</b>	<b>53</b>	<b>C32D</b>
SERIES	FUNCTION	FINISH

## SELECTION GUIDE

SERIES	FUNCTION <sup>1</sup>	FINISH <sup>1</sup>	/CASE
GX1B	10 Passage	C32D	6
GX1B	42 Privacy	C32D	6
GX1B	53 Entry ↔	C32D	6
GX1B	53IC Entry SFIC, less core ↔	C32D	6
GX1B	60 Store ↔	C32D	6
GX1B	60IC Store SFIC, less core ↔	C32D	6
GX1B	70 Classroom ↔	C32D	6
GX1B	70IC Classroom SFIC, less core ↔	C32D	6
GX1B	80 Storeroom ↔	C32D	6
GX1B	80IC Storeroom SFIC, less core ↔	C32D	6

(1) OTHER FINISHES AND FUNCTIONS AVAILABLE, MINIMUM ORDER QUANTITIES AND/OR ADDITIONAL DELIVERY TIMES MAY BE REQUIRED  
 ↔ KEYED FUNCTION; FULL KEYING SERVICES AVAILABLE

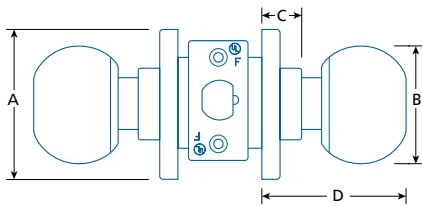

	A	B	C	D*
<b>GX1B</b>	2 <sup>15</sup> / <sub>16</sub> (74.6)	2 <sup>1</sup> / <sub>4</sub> (57)	1 <sup>3</sup> / <sub>16</sub> (21)	2 <sup>5</sup> / <sub>8</sub> -3 (67-76)
IN (MM)	(*) DIMENSION MAY VARY DUE TO DOOR THICKNESS.			

## PARTS & ACCESSORIES



**9106**  
T-Strike, square corners:  
1<sup>1</sup>/<sub>8</sub>x2<sup>3</sup>/<sub>4</sub>" (28.5x70 mm)



**9106NH**  
T-Strike, no hole; square corners:  
1<sup>1</sup>/<sub>8</sub>x2<sup>3</sup>/<sub>4</sub>" (28.5x70 mm)



**9807**  
CX5 high security SFIC core, 7 pin, 0 bitted

**CX5-TPICB**  
GX1B tailpiece for use with CX5 SFIC cores

**CBI-BF6KD-26D**  
BEST® F type SFIC core, 6 pin, keyed different

**CBI-BF7KD-26D**  
BEST® F type SFIC core, 7 pin, keyed different

**TPICB**  
Knob tailpiece for use with CX5 SFIC cores



**GX1SL238**  
Passage latch: 2<sup>3</sup>/<sub>8</sub>" (60 mm) backset  
1<sup>1</sup>/<sub>8</sub>x2<sup>1</sup>/<sub>4</sub>" (28.5x57 mm) faceplate



**GX1SL234**  
Passage latch: 2<sup>3</sup>/<sub>4</sub>" (70 mm) backset  
1<sup>1</sup>/<sub>8</sub>x2<sup>1</sup>/<sub>4</sub>" (28.5x57 mm) faceplate



**GX1PL238**  
Privacy latch: 2<sup>3</sup>/<sub>8</sub>" (60 mm) backset  
1<sup>1</sup>/<sub>8</sub>x2<sup>1</sup>/<sub>4</sub>" (28.5x57 mm) faceplate



**GX1PL234**  
Privacy latch: 2<sup>3</sup>/<sub>4</sub>" (70 mm) backset  
1<sup>1</sup>/<sub>8</sub>x2<sup>1</sup>/<sub>4</sub>" (28.5x57 mm) faceplate

**GX1DL238**  
Deadlatch: 2<sup>3</sup>/<sub>8</sub>" (60) backset  
1<sup>1</sup>/<sub>8</sub>x2<sup>1</sup>/<sub>4</sub>" (28.5x57 mm) faceplate

**GX1DL234**  
Deadlatch: 2<sup>3</sup>/<sub>4</sub>" (70 mm) backset  
1<sup>1</sup>/<sub>8</sub>x2<sup>1</sup>/<sub>4</sub>" (28.5x57 mm) faceplate

**GX1DL234-34**  
Deadlatch: 2<sup>3</sup>/<sub>4</sub>" (70 mm) backset, <sup>3</sup>/<sub>4</sub>" (19 mm) throw, 1<sup>1</sup>/<sub>8</sub>x2<sup>1</sup>/<sub>4</sub>" (28.5x57 mm) faceplate  
*For use in double door or electric strike applications*



**GX1LE334**  
Backset extension to 3<sup>3</sup>/<sub>4</sub>" (95 mm); use with 2<sup>3</sup>/<sub>8</sub>" (60 mm) backset latch

**GX1LE500**  
Backset extension to 5" (127 mm); use with 2<sup>3</sup>/<sub>4</sub>" (70 mm) backset latch





- Type** • Cylindrical lock
  - Certifications**
    - Conforms to ANSI/BHMA A156.2, Series 4000, Grade 2
    - cULus listed, 3hr fire-rating
    - UL 10C Positive Pressure Rating
    - 5 Year limited warranty
  - Door Thickness** • 1<sup>3</sup>/<sub>8</sub>–1<sup>3</sup>/<sub>4</sub>" (35–44.5 mm)
  - Handing** • Non handed
  - Backset**
    - 2<sup>3</sup>/<sub>4</sub>" (70 mm)
    - 2<sup>3</sup>/<sub>8</sub>" (60 mm) – available
    - 3<sup>3</sup>/<sub>4</sub>" (95 mm) – available
    - 5" (127 mm) – available
  - Spring Latch** • Stainless steel, 1/2" (12.7 mm) throw
  - Faceplate**
    - Mortise type, square corners
    - 1<sup>1</sup>/<sub>8</sub>x2<sup>1</sup>/<sub>4</sub>" (28.5x57 mm)
    - 2<sup>3</sup>/<sub>8</sub>" (60 mm) backset: 1x2<sup>1</sup>/<sub>4</sub>" (25.4x57mm)
  - Strike** • ASA Strike
  - Trim**
    - Brass or stainless steel knob\*
    - Brass or stainless steel rose\*
    - Rose diameter: 3" (76 mm)
- (\*) Material dependant on finish.

- Chassis** • Concealed mounting plate and screws
  - Preparation**
    - Cross bore: 2<sup>1</sup>/<sub>8</sub>" (54 mm)
    - Edge bore: 1" (25.4 mm)
  - Cylinder**
    - Solid brass, 6-pin
    - Schlage "C" keyway, 2 keys
    - Removable, rekeyable

*Other keyways and keying options available, including CX5 high security*
  - Functions**

10 Passage	60 Store
15 Exit	70 Classroom
17 Dummy, single	79 Institution exit
32 Patio	80 Storeroom*
42 Privacy	82 Institution/utility
53 Entry*	

(\*) Available without core cylinder (LC)
  - Finish** C3–Polished brass, C32D–Stainless steel
- Other finishes available by special order*

TL	53	B	C32D	238
SERIES	FUNCTION	STYLE	FINISH	OPTION <sup>1</sup>
(1) OPTION: 238 2-3/8IN (60MM) BACKSET LC–LESS CORE (53 & 80)				

## SELECTION GUIDE

SERIES	FUNCTION <sup>1</sup>	STYLE	FINISH <sup>1</sup>	/ CASE
TL	10 Passage	B	C3, C32D	20
TL	15 Exit	B	C3, C32D	20
TL	17 Dummy, single	B	C3, C32D	40
TL	32 Patio (includes full-lip D-Strike)	B	C32D	20
TL	42 Privacy	B	C3, C32D	20
TL	53 Entry ↔	B	C3, C32D	20
TL	53 LC Entry, housing only (less core) ↔	B	C32D	20
TL	60 Store ↔	B	C32D	20
TL	70 Classroom ↔	B	C3, C32D	20
TL	79 Institution / exit ↔	B	C32D	20
TL	80 Storeroom ↔	B	C3, C32D	20
TL	80 LC Storeroom, housing only (less core) ↔	B	C32D	20
TL	82 Institution / utility ↔	B	C32D	20



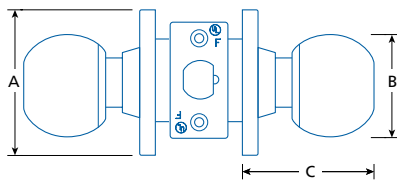





(1) OTHER FINISHES AND FUNCTIONS AVAILABLE, MINIMUM ORDER QUANTITIES AND/OR ADDITIONAL DELIVERY TIMES MAY BE REQUIRED  
 ↔ KEYED FUNCTION; FULL KEYING SERVICES AVAILABLE



	A	B	C
<b>TL B</b>	3 (76)	2 $\frac{1}{8}$ (57)	2 $\frac{5}{8}$ (67)

IN (MM)

## PARTS & ACCESSORIES

-  **9102**  
Full lip D-Strike, adjustable tab; square corners:  
1 $\frac{3}{4}$ x2 $\frac{1}{4}$ " (44.5x57 mm)
-  **9106**  
T-Strike, square corners:  
1 $\frac{1}{8}$ x2 $\frac{3}{4}$ " (28.5x70 mm)
-  **9106NH**  
T-Strike, no hole; square corners:  
1 $\frac{1}{8}$ x2 $\frac{3}{4}$ " (28.5x70 mm)
-  **ASA-T**  
ASA strike, adjustable tab; square corners
-  **ASANH**  
ASA strike, no hole; square corners
-  **TL020**  
Plastic spacer for latches with 1 x 2 $\frac{1}{4}$ "  
(25.4x57 mm) faceplate to fit preparations  
for 1 $\frac{1}{8}$ x2 $\frac{1}{4}$ " (28.5x57 mm) faceplates
-  **TL013**  
Backset extension to 3 $\frac{3}{4}$ " (95 mm);  
Use with 2 $\frac{3}{8}$ " (60 mm) backset latch
-  **TL014**  
Backset extension to 5" (127 mm);  
Use with 2 $\frac{3}{4}$ " (70 mm) backset latch Use with  
2 $\frac{3}{4}$ " (70 mm) backset latch



**TL001**  
Passage latch: 2 $\frac{3}{8}$ " (60 mm) backset,  
1x2 $\frac{1}{4}$ " (25.4x57 mm) faceplate

**TL003**  
Passage latch: 2 $\frac{3}{4}$ " (70 mm) backset,  
1 $\frac{1}{8}$ x2 $\frac{1}{4}$ " (28.5x57 mm) faceplate

**TL010**  
Privacy latch: 2 $\frac{3}{8}$ " (60 mm) backset,  
1x2 $\frac{1}{4}$ " (25.4x57 mm) faceplate

**TL002**  
Privacy latch: 2 $\frac{3}{4}$ " (70 mm) backset,  
1 $\frac{1}{8}$ x2 $\frac{1}{4}$ " (28.5x57 mm) faceplate



**TL005**  
Deadlatch 2 $\frac{3}{8}$ " (60 mm) backset  
1x2 $\frac{1}{4}$ " (25.4x57 mm) faceplate

**TL004**  
Deadlatch: 2 $\frac{3}{4}$ " (70 mm) backset,  
1 $\frac{1}{8}$ x2 $\frac{1}{4}$ " (28.5x57 mm) faceplate

**TL006**  
Deadlatch: 5" (127 mm) backset,  
1 $\frac{1}{8}$ x2 $\frac{1}{4}$ " (28.5x57 mm) faceplate

**TL011** (for function 32 or 94)  
Deadlatch: 2 $\frac{3}{8}$ " (60 mm) backset,  
1x2 $\frac{1}{4}$ " (25.4x57 mm) faceplate

**TL012** (for function 32 or 94)  
Deadlatch: 2 $\frac{3}{4}$ " (70 mm) backset,  
1 $\frac{1}{8}$ x2 $\frac{1}{4}$ " (28.5x57 mm) faceplate





- Type** • Cylindrical lock
  - Certifications**
    - Conforms to ANSI/BHMA A156.2, Series 4000, Grade 2
    - cULus listed, 3hr fire-rating
    - UL 10C Positive Pressure Rating
    - 10 Year limited warranty
  - Door Thickness** • 1<sup>3</sup>/<sub>8</sub>–2<sup>1</sup>/<sub>4</sub>" (35–57 mm)
  - Handing** • Non handed
  - Backset**
    - 2<sup>3</sup>/<sub>4</sub>" (70 mm)
    - 2<sup>3</sup>/<sub>8</sub>" (60 mm) – available
    - 3<sup>3</sup>/<sub>4</sub>" (95 mm) – available
    - 5" (127 mm) – available
  - Spring Latch** • Stainless steel, 1/2" (12.7 mm) throw
  - Faceplate**
    - Mortise type, square corners
    - 1<sup>1</sup>/<sub>8</sub>x2<sup>1</sup>/<sub>4</sub>" (28.5x57 mm)
    - 2<sup>3</sup>/<sub>8</sub>" (60 mm) backset : 1 x 2<sup>1</sup>/<sub>4</sub>" (25.4x57mm)
  - Strike** • ASA Strike
  - Trim**
    - Brass or stainless steel knob\*
    - Brass or stainless steel rose\*
    - Rose diameter: 3" (76 mm)
- (\*) Material dependant on finish.

- Chassis** • Concealed mounting plate and screws
  - Preparation**
    - Cross bore: 2<sup>1</sup>/<sub>8</sub>" (54 mm)
    - Edge bore: 1" (25.4 mm)
  - Cylinder**
    - Solid brass, 6-pin
    - Schlage "C" keyway, 2 keys
    - Removable, rekeyable

*Other keyways and keying options available.*
  - Functions**

00 Dummy, single	70 Classroom*
10 Passage	80 Storeroom*
40 Privacy	89 Exit
53 Entry*	

(\*) Available without core cylinder (LC)
  - Finish** C3–Polished brass, C32D–Stainless steel
- Other finishes available by special order*

T2B	53	C32D	238
SERIES	FUNCTION	FINISH	OPTION <sup>1</sup>

(1) OPTION: 238 2-3/8IN (60MM) BACKSET LC-LESS CORE (53 & 80)

## SELECTION GUIDE

SERIES	FUNCTION <sup>1</sup>	FINISH <sup>1</sup>	/ CASE
T2B	00 Dummy, single	C3, C32D	100
T2B	10 Passage	C3, C32D	20
T2B	40 Privacy	C3, C32D	20
T2B	53 Entry ↻	C3, C32D	20
T2B	53 LC Entry, housing only (less core) ↻	C3, C32D	20
T2B	70 Classroom ↻	C3, C32D	20
T2B	70 LC Classroom, housing only (less core) ↻	C32D	20
T2B	80 Storeroom ↻	C3, C32D	20
T2B	80 LC Storeroom, housing only (less core) ↻	C3, C32D	20
T2B	89 Exit	C3, C32D	20

(1) OTHER FINISHES AND FUNCTIONS AVAILABLE, MINIMUM ORDER QUANTITIES AND/OR ADDITIONAL DELIVERY TIMES MAY BE REQUIRED

↻ KEYED FUNCTION; FULL KEYING SERVICES AVAILABLE

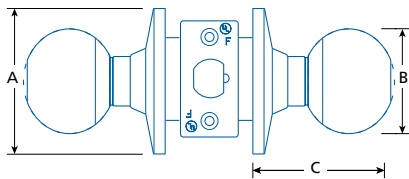

	A	B	C*
<b>B</b> (NON KEYED)	3 (76)	2 <sup>1</sup> / <sub>8</sub> (54)	2 <sup>5</sup> / <sub>8</sub> -3 <sup>1</sup> / <sub>16</sub> (67-78)
<b>B</b> (KEYED)			2 <sup>9</sup> / <sub>16</sub> -3 (65-76)

IN (MM) (\*) DIMENSION VARIES WITH DOOR THICKNESS.

## PARTS & ACCESSORIES



**9102**  
Full lip D-Strike, adjustable tab; square corners:  
1<sup>3</sup>/<sub>4</sub>x2<sup>1</sup>/<sub>4</sub>" (44.5x57 mm)



**9106**  
T-Strike, square corners:  
1<sup>1</sup>/<sub>8</sub>x2<sup>3</sup>/<sub>4</sub>" (28.5x70 mm)



**9106NH**  
T-Strike, no hole; square corners:  
1<sup>1</sup>/<sub>8</sub>x2<sup>3</sup>/<sub>4</sub>" (28.5x70 mm)



**ASA-T**  
ASA strike, adjustable tab; square corners



**ASANH**  
ASA strike, no hole; square corners



**TL020**  
Plastic spacer for latches with 1 x 2<sup>1</sup>/<sub>4</sub>"  
(25.4x57 mm) faceplate to fit preparations  
for 1<sup>1</sup>/<sub>8</sub>x2<sup>3</sup>/<sub>4</sub>" (28.5x57 mm) faceplates

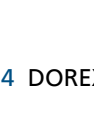

**TL013**  
Backset extension to 3<sup>3</sup>/<sub>4</sub>" (95 mm);  
Use with 2<sup>3</sup>/<sub>8</sub>" (60 mm) backset latch



**TL014**  
Backset extension to 5" (127 mm);  
Use with 2<sup>3</sup>/<sub>4</sub>" (70 mm) backset latch Use with  
2<sup>3</sup>/<sub>4</sub>" (70 mm) backset latch



**TL001**  
Passage latch: 2<sup>3</sup>/<sub>8</sub>" (60 mm) backset,  
1x2<sup>1</sup>/<sub>4</sub>" (25.4x57 mm) faceplate



**TL003**  
Passage latch: 2<sup>3</sup>/<sub>4</sub>" (70 mm) backset,  
1<sup>1</sup>/<sub>8</sub>x2<sup>1</sup>/<sub>4</sub>" (28.5x57 mm) faceplate



**TL010**  
Privacy latch: 2<sup>3</sup>/<sub>8</sub>" (60 mm) backset,  
1x2<sup>1</sup>/<sub>4</sub>" (25.4x57 mm) faceplate



**TL002**  
Privacy latch: 2<sup>3</sup>/<sub>4</sub>" (70 mm) backset,  
1<sup>1</sup>/<sub>8</sub>x2<sup>1</sup>/<sub>4</sub>" (28.5x57 mm) faceplate



**TL005**  
Deadlatch 2<sup>3</sup>/<sub>8</sub>" (60 mm) backset  
1x2<sup>1</sup>/<sub>4</sub>" (25.4x57 mm) faceplate

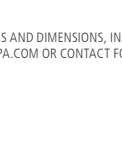

**TL004**  
Deadlatch: 2<sup>3</sup>/<sub>4</sub>" (70 mm) backset,  
1<sup>1</sup>/<sub>8</sub>x2<sup>1</sup>/<sub>4</sub>" (28.5x57 mm) faceplate



**TL006**  
Deadlatch: 5" (127 mm) backset,  
1<sup>1</sup>/<sub>8</sub>x2<sup>1</sup>/<sub>4</sub>" (28.5x57 mm) faceplate





IL80EMC15KDS shown,  
Storeroom, double lock

- Type** • Interconnected cylindrical lock
- Certifications**
  - Conforms to ANSI/BHMA A156.12, Grade 2
  - cULus listed, 3 hour fire-rating
  - UL10C Positive Pressure Rating
  - Meets ADA requirements
  - 1 Year limited warranty
- Door Thickness** • 1<sup>3</sup>/<sub>8</sub>–1<sup>3</sup>/<sub>4</sub>" (35–44.5 mm)
- Handing** • Non handed
- Backset**
  - 2<sup>3</sup>/<sub>4</sub>" (70 mm)
  - 2<sup>3</sup>/<sub>8</sub>" (60 mm) – available
- Spring Latch**
  - Stainless steel
  - 1/2" (12.7 mm) throw
- Deadbolt**
  - Solid brass with hardened steel security pin
  - 1" (25.4 mm) throw
- Faceplate**
  - Mortise type, square corners
  - 1<sup>1</sup>/<sub>8</sub>x2<sup>1</sup>/<sub>4</sub>" (28.5x57 mm)
- Strikes**
  - T-Strike: 1<sup>1</sup>/<sub>8</sub>x2<sup>3</sup>/<sub>4</sub>" (28.5x70 mm)
  - Deadbolt strike: 1<sup>1</sup>/<sub>8</sub>x2<sup>3</sup>/<sub>4</sub>" (28.5x70 mm)
  - Plastic dust-boxes
- Interior Escutcheon**
  - Square (S): 8x3<sup>1</sup>/<sub>8</sub>" (203x79 mm)
  - Round (R): 8<sup>7</sup>/<sub>8</sub>x3<sup>1</sup>/<sub>8</sub>" (225x79 mm)

- Exterior Escutcheon**
  - Square: 8x3<sup>1</sup>/<sub>8</sub>" (203x79 mm)
  - Round: 8<sup>7</sup>/<sub>8</sub>x3<sup>1</sup>/<sub>8</sub>" (225x79 mm)

*Not included, sold separately*
- Chassis**
  - Free-spinning deadbolt cylinder collar
  - Steel deadbolt cylinder housing
  - Exposed mounting screws
  - Single action egress
- Preparation**
  - 4" (102 mm) centre-to-centre installation
  - Cross bore: 2<sup>1</sup>/<sub>8</sub>" (54 mm)
  - Edge bore: 1" (25.4 mm)
- Cylinder**
  - Solid brass, 6-pin
  - Schlage "C" keyway, 2 keys
  - Removable, rekeyable

*Other keyways and keying options available, including CX5 high security*
- Functions**
  - 10 Passage, single lock
  - 80 Storeroom, double lock
- Lever Styles** EM–Standard return
 

*Other lever styles available by special order*
- Finish** C15–Satin nickel
 

*Other finishes available by special order*

IL	10	EM	C15	KD	S	238
SERIES	FUNCTION	STYLE	FINISH	KEYING	TRIM	OPTION <sup>1</sup>

(1) OPTIONS: 238 2-3/8IN (60MM) BACKSET

## SELECTION GUIDE

SERIES	FUNCTION	LEVER	INTERIOR TRIM	FINISH	/CASE
IL	10 Passage, single lock entry	EM	R, S	C15	10
IL	80 Storeroom, double lock entry	EM	S	C15	10

OTHER FINISHES AND FUNCTIONS AVAILABLE, MINIMUM ORDER QUANTITIES AND/OR ADDITIONAL DELIVERY TIMES MAY BE REQUIRED EXTERIOR ESCUTCHEON SOLD SEPARATELY  
 KEYED FUNCTION; FULL KEYING SERVICES AVAILABLE

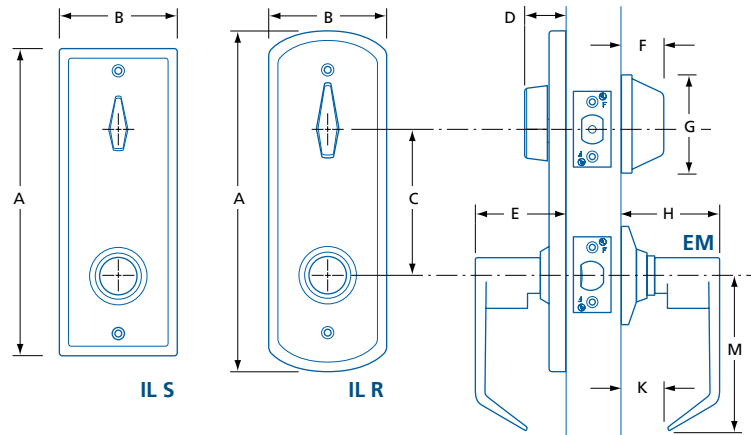

		A	B	C	D	E	F	G	H*	K*	M	P
IL R	EM	8 <sup>7</sup> / <sub>8</sub> (225.4)	3 <sup>1</sup> / <sub>8</sub> (79)	4 (101.6)	1 <sup>1</sup> / <sub>16</sub> (27)	2 <sup>9</sup> / <sub>16</sub> (65)	1 <sup>1</sup> / <sub>16</sub> (27.2)	2 <sup>9</sup> / <sub>16</sub> (65)	2 <sup>5</sup> / <sub>16</sub> (59)	3/ <sub>8</sub> (9.5)	4 (102)	2 <sup>9</sup> / <sub>16</sub> (65)
IL S	EM	8 (203.2)	3 <sup>1</sup> / <sub>8</sub> (79)	4 (101.6)	1 <sup>1</sup> / <sub>16</sub> (27)	2 <sup>1</sup> / <sub>8</sub> (54)	1 <sup>1</sup> / <sub>16</sub> (27.2)	2 <sup>9</sup> / <sub>16</sub> (65)	2 <sup>5</sup> / <sub>16</sub> (59)	3/ <sub>8</sub> (9.5)	4 (102)	2 <sup>9</sup> / <sub>16</sub> (65)

IN (MM) (\*) DIMENSION MAY VARY DUE TO DOOR THICKNESS NOTE: EXTERIOR ESCUTCHEON PLATES ARE THE SAME SIZE AS THE INTERIOR ONES (SOLD SEPARATELY)

## PARTS & ACCESSORIES



**ILPRC15**  
 Exterior escutcheon, round  
 8<sup>7</sup>/<sub>8</sub> x 3<sup>1</sup>/<sub>8</sub> x 7<sup>1</sup>/<sub>16</sub>" (225 x 79 x 11 mm)  
 Not included



**ILPSC15**  
 Exterior escutcheon, square  
 8 x 3<sup>1</sup>/<sub>8</sub> x 7<sup>1</sup>/<sub>16</sub>" (203 x 79 x 11 mm)  
 Not included





LS  
Square rose

- Type** • Interconnected tubular lock
- Certifications**
  - Conforms to ANSI/BHMA A156.12, Grade 2
  - cULus listed, 3 hour fire-rating
  - UL10C Positive Pressure Rating
  - Lever meets ADA requirements
  - 1 Year limited warranty
- Door Thickness** • 1¾–2½" (45–55 mm)
- Handing** • Non handed
- Backset** • 2¾ – 2¾" (60–70 mm), adjustable
- Spring Latch**
  - Stainless steel
  - ½" (12.5 mm) throw
- Deadbolt**
  - Steel with hardened steel security pin
  - 1" (25.4 mm) throw
- Faceplate**
  - Mortise type, square corners
  - 1½x2¼" (28.5x57 mm)
- Strikes**
  - T-Strike: 1½x2¾" (28x70 mm)
  - Deadbolt strike: 1½x2¾" (28x70 mm)
  - Plastic dust-boxes

- Interior Escutcheon** • 8½x2¾" (216x70 mm)
- Chassis**
  - Concealed mounting screws
  - Visible lever set-screws
  - Single action egress
- Preparation**
  - 5½" (140 mm) centre-to-centre installation
  - Cross bore: 2½" (54 mm)
  - Edge bore: 1" (25.4 mm)
- Cylinder**
  - Solid brass, 6-pin
  - Schlage "C" keyway, 2 keys
- Function** 55 Suite entry, single lock, with single action egress
- Lever Styles** L–Lina, LS–Lina (square rose)  
*Other lever styles available by special order*
- Finish** 15–Satin nickel, 19–Matte black  
*Other finishes available by special order*

T2IL	55	L	-	15	KD	M
SERIES	FUNCTION	STYLE	FINISH	KEYING	LATCH	

## SELECTION GUIDE

SERIES	FUNCTION	LEVER	FINISH	/CASE
T2 IL	55 Suite entry, single lock, with single action egress 	L, LS	15, 19	10

OTHER FINISHES AND FUNCTIONS AVAILABLE, MINIMUM ORDER QUANTITIES AND/OR ADDITIONAL DELIVERY TIMES MAY BE REQUIRED  
 KEYED FUNCTION

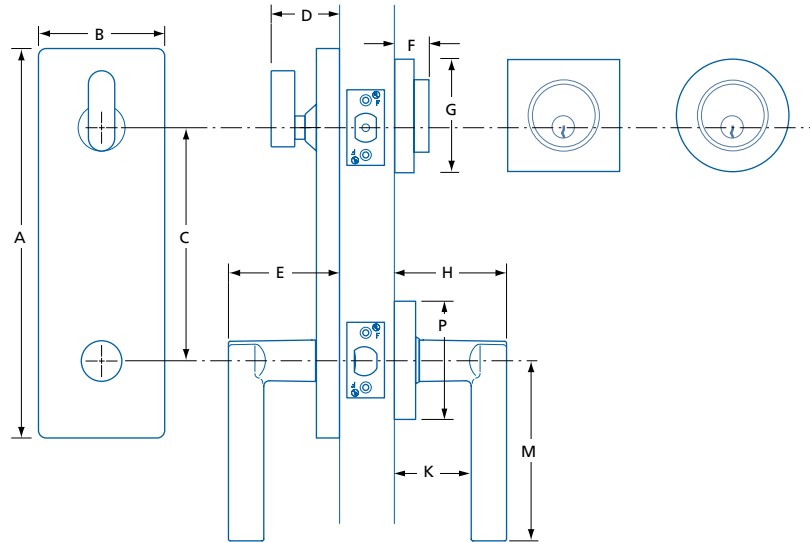

	A	B	C	D	E	F	G	H	K	M	P
<b>T2 IL</b>	8½ (216)	2¾ (70)	5½ (140)	1½ (38)	2½ (63.5)	¾ (19)	2½ (63.5)	2½ (63.5)	1⅝ (41.3)	4 (101.6)	2½ (63.5)

IN (MM)





- Certifications**
- Conforms to ANSI/BHMA A156.36, Grade 1
  - cULus listed, 3hr fire-rating
  - 10 Year limited warranty
- Door Thickness**
- 1 $\frac{1}{16}$ –2" (40–51 mm)
  - Kit for 2 $\frac{1}{4}$ " (57 mm) – available
- Handing**
- Non handed
- Backset**
- 2 $\frac{3}{4}$ " (70 mm)
  - 2 $\frac{3}{8}$ " (60 mm) – available
- Deadbolt**
- Solid brass with hardened steel security pin
  - 1" (25.4 mm) throw
- Faceplate**
- Mortise type, square corners
  - 1 $\frac{1}{8}$ x2 $\frac{1}{4}$ " (29x57 mm)
- Strikes**
- Wood & steel frame strikes; square corners
  - 1 $\frac{1}{8}$ x2 $\frac{3}{4}$ " (29x70 mm)
  - Plastic dust-box
- Other strikes available*
- Chassis**
- Free-spinning cylinder collar
  - Steel cylinder housing
  - Concealed mounting screws

- Preparation**
- Cross bore: 2 $\frac{1}{8}$ " (54 mm)
  - Edge bore: 1" (25.4 mm)
- Cylinder**
- Solid brass, 6-pin
  - Schlage "C" keyway, 2 keys
  - Removable, rekeyable
  - Small format interchangeable core (SFIC) model – available\*
- Other keyways and keying options available, including CX5 high security. (\*) BEST® and CX5® cores sold separately.*
- Functions**
- 51 Single cylinder, thumb-turn
  - 60 Double cylinder
  - 70 Single cylinder, thumb-turn (Classroom)
- Less Core (LC) available – see selection guide*
- Finish**
- C15–Satin nickel, C15A–Antique nickel, C26D–Satin chrome, C3–Polished brass, V3–Polished brass (Endurance)
- Other finishes available by special order*

GX1A	51	C26D	LC
SERIES	FUNCTION	FINISH	OPTION <sup>(1)</sup>

(1) OPTIONS: 238-2 3/8IN (60MM) BACKSET LC-LESS CORE (51 ONLY) WEI-WEISER KEYWAY

## SELECTION GUIDE

SERIES	FUNCTION <sup>1</sup>	FINISH <sup>1</sup>	/CASE
GX1A	51 Single cylinder, thumb-turn ↔	C15, C15A, C26D, C3, C5, V3	12
GX1A	51 LC Single cylinder, thumb-turn, less core ↔	C26D	12
GX1A	51 WEI Single cylinder, thumb-turn, 5-pin Weiser keyway ↔	C26D, C3, C5	12
GX1A	51 IC Single cylinder SFIC, thumb-turn, 7-pin BEST® F core included ↔	C15, C26D	12
GX1A	60 Double cylinder ↔	C26D	12
GX1A	60IC Double cylinder SFIC, 7-pin BEST® F core included ↔	C26D	12
GX1A	70 Single cylinder, thumb-turn (Classroom) ↔	C26D	12
GX1A	70IC Single cylinder SFIC, thumb-turn, 7-pin BEST® F core included (Classroom) ↔	C26D	12

(1) OTHER FINISHES AND FUNCTIONS AVAILABLE, MINIMUM ORDER QUANTITIES AND/OR ADDITIONAL DELIVERY TIMES MAY BE REQUIRED

↔ KEYED FUNCTION; FULL KEYING SERVICES AVAILABLE

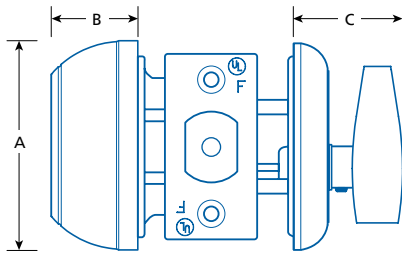

	A	B	C
GX1A	2 <sup>15</sup> / <sub>32</sub> (63)	1 <sup>1</sup> / <sub>16</sub> (27)	1 <sup>9</sup> / <sub>32</sub> (32.3)

IN (MM)

## PARTS & ACCESSORIES



**9111**  
Steel frame strike; square.  
1<sup>1</sup>/<sub>8</sub>x2<sup>3</sup>/<sub>4</sub>" (29x70mm)



**LM9111**  
Steel (square) and wood (round) frame security strikes.  
1<sup>1</sup>/<sub>8</sub>x2<sup>3</sup>/<sub>4</sub>" (29x70mm)



**9118**  
Wood frame strike; square.  
1<sup>1</sup>/<sub>8</sub>x2<sup>3</sup>/<sub>4</sub>" (29x70mm)

**9118R**  
Wood frame strike; round.  
1<sup>1</sup>/<sub>8</sub>x2<sup>3</sup>/<sub>4</sub>" (29x70mm)



**9807**  
CX5 high security SFIC core, 7 pin, 0 bitted

**CBI-BF6KD-26D**  
BEST® F type SFIC core, 6 pin, 0 bitted

**CBI-BF7KD-26D**  
BEST® F type SFIC core, 7 pin, 0 bitted



**TL007**  
Deadbolt: 2<sup>3</sup>/<sub>8</sub>" (60 mm) backset,  
1 x 2<sup>1</sup>/<sub>4</sub>" (25.4x57 mm) faceplate

**TL008**  
Deadbolt: 2<sup>3</sup>/<sub>4</sub>" (70 mm) backset,  
1<sup>1</sup>/<sub>8</sub>x2<sup>1</sup>/<sub>4</sub>" (28.5x57 mm) faceplate



**TLA85052**  
Longer spindle and screw kit for 2<sup>1</sup>/<sub>4</sub>" (57 mm) thick door. For GX1A51 or GX1A70.

**TLA93110**  
Longer spindle and screw kit for 2<sup>1</sup>/<sub>4</sub>" (57 mm) thick door. For GX1A60.





**FHA 421**  
Privacy with indicator

- Certifications**
- Conforms to ANSI/BHMA A156.36, Grade 2
  - cULus listed, 3hr fire-rating
  - 1 Year limited warranty
- Door Thickness**
- 1 $\frac{3}{8}$ –1 $\frac{3}{4}$ " (35–44.5 mm)
- Handing**
- Non handed
- Backset**
- 2 $\frac{3}{8}$ –2 $\frac{3}{4}$ " (60–70 mm) adjustable
- Deadbolt**
- Solid brass with hardened steel security pin
  - 1" (25.4 mm) throw
- Faceplate**
- Mortise type, square corners
  - 1 $\frac{1}{8}$ x2 $\frac{1}{4}$ " (29x57 mm)
- Strike**
- 2-piece security strike (wood/metal frame)
  - 1 $\frac{1}{8}$ x2 $\frac{3}{4}$ " (29x70 mm), square corners
  - Plastic dust-box
- Other strikes available*

- Chassis**
- Free-spinning cylinder collar
  - Steel cylinder housing
  - Exposed mounting screws
- Preparation**
- Cross bore: 2 $\frac{1}{8}$ " (54 mm)
  - Edge bore: 1" (25.4 mm)
- Cylinder**
- Solid brass, 6-pin
  - Schlage "C" keyway, 2 keys
  - Removable, rekeyable
- Other keyways and keying options available, including CX5 high security*
- Functions**
- 421 Privacy with indicator
  - 51 Single cylinder, thumbturn
  - 60 Double cylinder
- Finish**
- C26D–Satin chrome, C3–Polished brass, C19–Matte black
- Other finishes available by special order*

FHA	51	C26D
SERIES	FUNCTION	FINISH

## SELECTION GUIDE

SERIES	FUNCTION <sup>1</sup>	FINISH <sup>1</sup>	/CASE
FHA	42I Privacy, with indicator*	C26D, C19	24
FHA	51 Single cylinder, with thumbturn ↻	C26D, C3	24
FHA	60 Double cylinder ↻	C26D, C3	24

(1) OTHER FINISHES AND FUNCTIONS AVAILABLE, MINIMUM ORDER QUANTITIES AND/OR ADDITIONAL DELIVERY TIMES MAY BE REQUIRED  
 ↻ KEYED FUNCTION; FULL KEYING SERVICES AVAILABLE (\*) NOT FIRE-RATED

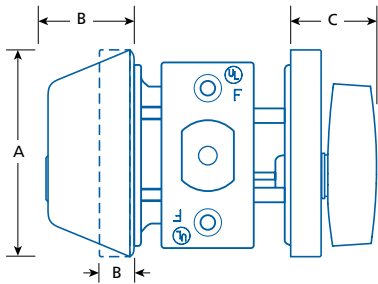

	A	B	C
<b>FHA</b>	2 <sup>9</sup> / <sub>16</sub> (65)	1 (25.4)	1 (25.4)
<b>FHA 42I</b>	2 <sup>1</sup> / <sub>2</sub> (63.5)	<sup>3</sup> / <sub>8</sub> (10)	<sup>13</sup> / <sub>16</sub> (30)

IN (MM)

## PARTS & ACCESSORIES



**9111**  
Steel frame strike; square.  
1<sup>1</sup>/<sub>8</sub> x 2<sup>3</sup>/<sub>4</sub>" (29 x 70 mm)



**9118**  
Wood frame strike; square.  
1<sup>1</sup>/<sub>8</sub> x 2<sup>3</sup>/<sub>4</sub>" (29 x 70 mm)

**9118R**  
Wood frame strike; round.  
1<sup>1</sup>/<sub>8</sub> x 2<sup>3</sup>/<sub>4</sub>" (29 x 70 mm)





**TLA 421**  
Privacy with indicator



- Certifications**
- Conforms to ANSI/BHMA A156.36, Grade 2
  - cULus listed, 3hr fire-rating\*
  - 5 Year limited warranty
- (\* ) Except privacy model 421

- Door Thickness**
- 1 $\frac{3}{8}$ –1 $\frac{3}{4}$ " (35–44.5 mm)
  - SFIC Model: 1 $\frac{1}{16}$ –2" (40–51 mm)
  - Kit for 2 $\frac{1}{4}$ " (57 mm) – available

- Handing**
- Non handed

- Backset**
- 2 $\frac{3}{4}$ " (70 mm)
  - 2 $\frac{3}{8}$ " (60 mm) – available
  - 2 $\frac{3}{8}$ –2 $\frac{3}{4}$ " (60–70 mm) adjustable – available

- Deadbolt**
- Solid brass with hardened steel security pin
  - 1" (25.4 mm) throw

- Faceplate**
- Mortise type, square corners
  - 1 $\frac{1}{8}$ x2 $\frac{1}{4}$ " (29x57 mm)

- Strike**
- 2-piece security strike (wood/metal frame)
  - 1 $\frac{1}{8}$ x2 $\frac{3}{4}$ " (29x70 mm), square corners
  - Plastic dust-box
- Other strikes available

- Chassis**
- Free-spinning cylinder collar
  - Steel cylinder housing
  - Exposed mounting screws

- Preparation**
- Cross bore: 1 $\frac{1}{2}$ " or 2 $\frac{1}{8}$ " (38 mm or 54 mm)\*
  - Edge bore: 1" (25.4 mm)
- (\* ) 1 $\frac{1}{2}$ " (38 mm) installation will negate Grade 2 conformity, but will retain fire-rating.

- Cylinder**
- Solid brass, 6-pin
  - Schlage "C" keyway, 2 keys
  - Removable, rekeyable
  - Small format interchangeable core (SFIC) model – available
- Other keyways and keying options available, including CX5 high security.

- Functions**
- 421 Privacy with indicator\*
  - 51 Single cylinder, thumb-turn
  - 57 Thumb-turn only, exterior plate
  - 60 Double cylinder
  - 70 Single cylinder, thumb-turn (Classroom)
- (\* ) Emergency unlock by emergency key or flat head screw driver. Emergency key is not included.

- Finish**
- C19–Matte black, C26D–Satin chrome, C3–Polished brass, C32D–Satin stainless steel
- Other finishes available by special order

TLA	51	C32D	-U
SERIES	FUNCTION	FINISH	OPTION <sup>1</sup>

(1) OPTIONS: 238–2 3/8IN (60MM) BACKSET -U–ADJUSTABLE BACKSET

## SELECTION GUIDE

SERIES	FUNCTION <sup>1</sup>	FINISH <sup>1</sup>	/CASE
TLA	42I Privacy, with indicator*	26D, 32D	20
TLA	51 Single cylinder with thumb-turn ↔	C19, C26D, C3, C32D	20
TLA	51-U Single cylinder with thumb-turn, adjustable backset option ↔	C26D, C32D	20
TLA	51IC Single cylinder with thumb-turn (BEST@ F, 7-pin SFIC included) ↔	C26D, C32D	20
TLA	57 Thumb-turn only with blank exterior plate	C26D	20
TLA	60 Double cylinder ↔	C3, C32D	20
TLA	60-U Double cylinder, adjustable backset option ↔	C32D	20
TLA	70 Single cylinder, with thumb-turn (Classroom) ↔	C32D	20

(1) OTHER FINISHES AND FUNCTIONS AVAILABLE, MINIMUM ORDER QUANTITIES AND/OR ADDITIONAL DELIVERY TIMES MAY BE REQUIRED

↔ KEYED FUNCTION; FULL KEYING SERVICES AVAILABLE (\*) CANNOT ACCOMMODATE DOORS THICKER THAN 1-3/4IN (44.5 MM); NOT FIRE-RATED

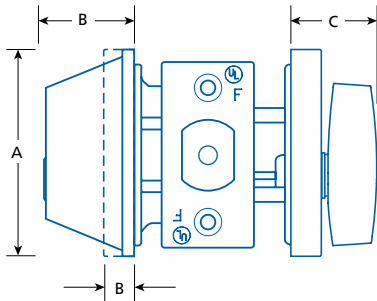

	ø A	B	C
TLA	2 9/16 (65)	1 1/8 (29)	1 (25)
TLA 42I	2 9/16 (65)	1 1/32 (8.5)	1 (25)
TLA 57	2 9/16 (65)	1 1/32 (8.5)	1 (25)

IN (MM)

## PARTS & ACCESSORIES



**9111**  
Steel frame strike; square.  
1 1/8 x 2 3/4" (29 x 70 mm)



**9118**  
Wood frame strike; square.  
1 1/8 x 2 3/4" (29 x 70 mm)

**9118R**  
Wood frame strike; round.  
1 1/8 x 2 3/4" (29 x 70 mm)



**9807**  
CX5 high security SFIC core, 7 pin, 0 bitted

**CBI-BF6KD-26D**  
BEST@ F type SFIC core, 6 pin, keyed different

**CBI-BF7KD-26D**  
BEST@ F type SFIC core, 7 pin, keyed different



**TLA42-EKEY**  
Emergency key for TLA 42I.



**TL007**  
Deadbolt: 2 3/8" (60 mm) backset,  
1 x 2 1/4" (25.4 x 57 mm) faceplate

**TL008**  
Deadbolt: 2 3/4" (70 mm) backset,  
1 1/8 x 2 1/4" (28.5 x 57 mm) faceplate

**TLA-LBU**  
Deadbolt: 2 3/8-2 3/4" (60-70 mm) adjustable  
backset, 1 x 2 1/4" (25.4 x 57 mm) faceplate



**TL020**  
Plastic spacer for latches with 1 x 2 1/4"  
(25.4 x 57 mm) faceplate to fit preparations  
for 1 1/8 x 2 1/4" (28.5 x 57 mm) faceplates



**TLA85052**  
Longer spindle and screw kit for 2 1/4" (57 mm)  
thick door. For TLA 51 or TLA 70 only, cannot  
be used with TLA 42I Indicator model.

**TLA93110**  
Longer spindle and screw kit for 2 1/4" (57 mm)  
thick door. For TLA 60.





- Certifications**
- Conforms to ANSI/BHMA A156.36, Grade 1
  - cULus listed, 3hr fire-rating
  - 5 Year limited warranty

- Door Thickness**
- 1 $\frac{3}{8}$ –2" (35–51 mm)

- Handing**
- Non handed

- Backset**
- 2 $\frac{3}{4}$ " (70 mm)
  - 2 $\frac{3}{8}$ " (60 mm) – available

- Spring Latch**
- Solid brass deadlatch
  - $\frac{5}{8}$ " (15.9mm) throw

- Faceplate**
- Mortise type, square corners
  - 1 $\frac{1}{8}$ x2 $\frac{1}{4}$ " (29x57 mm)
  - Self-adjustable for bevelled doors

- Strikes**
- T-type strike, 1 $\frac{1}{8}$ x2 $\frac{3}{4}$ " (29x70 mm)
  - Wood frame security plate with 3" (76 mm) wood screws
  - Plastic dust-box

- Chassis**
- Die-cast trim ring with protective shield
  - Free-spinning solid brass cylinder collar
  - High-strength steel cylinder housing
  - Through bolt mounted
  - Exposed mounting screws

- Preparation**
- Cross bore: 2 $\frac{1}{8}$ " (54 mm)
  - Edge bore: 1" (25.4 mm)

- Cylinder**
- Solid brass, 6-pin
  - Schlage "C" keyway, 2 keys
  - Removable, rekeyable
  - Small format interchangeable core (SFIC) model – available\*

*Other keyways and keying options available, including CX5 high security. (\*) Special order.*

- Functions** 51 Single cylinder, thumb-turn

- Finish** 26D–Satin chrome

*Other finishes available by special order*

DG1	AN	51	–	26D
SERIES		FUNCTION		FINISH

## SELECTION GUIDE

SERIES	FUNCTION <sup>1</sup>	FINISH <sup>1</sup>	/CASE
DG1	51 Single cylinder, thumb-turn	26D	12

(1) OTHER FINISHES AND FUNCTIONS AVAILABLE, MINIMUM ORDER QUANTITIES AND/OR ADDITIONAL DELIVERY TIMES MAY BE REQUIRED  
 • KEYED FUNCTION; FULL KEYING SERVICES AVAILABLE

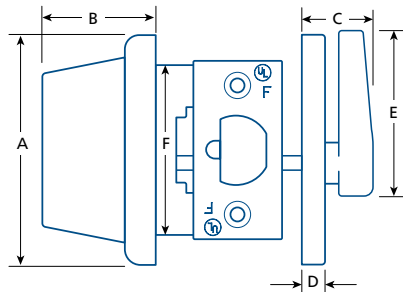

	A	B	C	D	E	F
DG1	2 <sup>5</sup> / <sub>8</sub> (67)	1 <sup>9</sup> / <sub>32</sub> (32.5)	1 <sup>5</sup> / <sub>16</sub> (24)	9/ <sub>32</sub> (7)	1 <sup>3</sup> / <sub>4</sub> (44.5)	2 (51)

IN (MM)

## PARTS & ACCESSORIES



### DGPL238

Deadlatch: 2<sup>3</sup>/<sub>8</sub>" (60 mm) backset,  
 1<sup>1</sup>/<sub>8</sub> x 2<sup>1</sup>/<sub>4</sub>" (28.5 x 57 mm) faceplate





- Certifications**
- Conforms to ANSI/BHMA A156.36, Grade 2
  - cULus listed, 3hr fire-rating
  - 5 Year limited warranty

- Door Thickness**
- 1 $\frac{3}{8}$ –2" (35–51 mm)

- Handing**
- Non handed

- Backset**
- 2 $\frac{3}{4}$ " (70 mm)
  - 2 $\frac{3}{8}$ " (60 mm) – available

- Spring Latch**
- Solid brass deadlatch
  - $\frac{5}{8}$ " (15.9mm) throw

- Faceplate**
- Mortise type, square corners
  - 1 $\frac{1}{8}$ x2 $\frac{1}{4}$ " (29x57 mm)
  - Self-adjustable for bevelled doors

- Strikes**
- T-type strike, 1 $\frac{1}{8}$ x2 $\frac{3}{4}$ " (29x70 mm)
  - Wood frame security plate with 3" (76 mm) wood screws
  - Plastic dust-box

- Chassis**
- Die-cast trim ring
  - Free-spinning solid brass cylinder collar
  - High-strength steel cylinder housing
  - Through bolt mounted
  - Exposed mounting screws

- Preparation**
- Cross bore: 2 $\frac{1}{8}$ " (54 mm)
  - Edge bore: 1" (25.4 mm)

- Cylinder**
- Solid brass, 6-pin
  - Schlage "C" keyway, 2 keys
  - Removable, rekeyable
  - Small format interchangeable core (SFIC) model – available\*

*Other keyways and keying options available, including CX5 high security. (\*) Special order.*

- Functions** 51 Single cylinder, thumb-turn

- Finish** 26D–Satin chrome

*Other finishes available by special order*

DG2	AN	51	–	26D
SERIES		FUNCTION		FINISH

## SELECTION GUIDE

SERIES	FUNCTION <sup>1</sup>	FINISH <sup>1</sup>	/CASE
DG2	51 Single cylinder, thumb-turn	26D	20

(1) OTHER FINISHES AND FUNCTIONS AVAILABLE, MINIMUM ORDER QUANTITIES AND/OR ADDITIONAL DELIVERY TIMES MAY BE REQUIRED  
 • KEYED FUNCTION; FULL KEYING SERVICES AVAILABLE

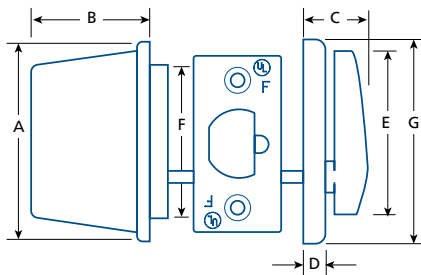

	A	B	C	D	E	F	G
DG2	2 <sup>5</sup> / <sub>8</sub> (67)	1 <sup>9</sup> / <sub>32</sub> (32.5)	1 <sup>5</sup> / <sub>16</sub> (24)	9 <sup>3</sup> / <sub>32</sub> (7)	1 <sup>3</sup> / <sub>4</sub> (44.5)	2 (51)	2 <sup>5</sup> / <sub>8</sub> (67)

IN (MM)

## PARTS & ACCESSORIES



### DGPL238

Deadlatch: 2<sup>3</sup>/<sub>8</sub>" (60 mm) backset,  
 1<sup>1</sup>/<sub>8</sub> x 2<sup>1</sup>/<sub>4</sub>" (28.5 x 57 mm) faceplate





**BHMA**  
CERTIFIED

**G1**

**UL**  
LISTED

**3H**

**♿**

**8**

**5**  
YEAR

- Certifications**
- Certified ANSI/BHMA A156.13, Series 1000, Grade 1
  - cULus listed, 3hr fire-rating
  - UL10C Positive Pressure Rated
  - Levers meet ADA (ANSI 117.1) requirements
  - 5 Year limited warranty

- Door Thickness**
- 1¾" (44.5 mm)
  - 2–2¼" (51–57 mm) – available

- Handing**
- Handed, field reversible

- Backset**
- 2¾" (70 mm)

- Spring Latch**
- Brass, anti-friction
  - ¾" (19 mm) throw
  - Auxiliary deadlocking latch

- Deadbolt**
- Solid bolt, 2 security pins
  - 1" (25.4 mm) throw

- Faceplate**
- 1¼ x 8" (32 x 203 mm), square corners
  - Adjusts for bevelled doors up to ⅛" (3 mm)

- Strike**
- ANSI-type strike and dust-box

- Cylinder**
- 6 pin mortise cylinder
  - Schlage "C" with 2 keys
  - Small format interchangeable core (SFIC) mortise housing available (SFIC not included)
- Other keyways and keying options available, including CX5 high security*

- Sectional Trim**
- Brass lever or knob
  - Brass rose
  - S–Round: ø 2⅞ x ½" (61.5 x 12.7 mm)
  - SQ–Square: 1⅞ x 1⅞ x ½" (48 x 48 x 12.7 mm)

- Escutcheon Trim**
- Brass lever or knob
  - Brass escutcheon
  - E–Regular 2 x 8⅞ x ½" (50 x 205 x 12.7 mm)
  - E2–Wide 2½ x 8⅞ x ½" (63 x 210 x 12.7 mm)
  - E3–Large 2¾ x 10¾ x ½" (70 x 273 x 12.7 mm)

- Chassis**
- Rose trim: concealed mounting screws
  - Thumb-turn: exposed mounting screws
  - Escutcheon: exposed mounting screws
  - Single action egress

- Functions**
- |                        |                          |
|------------------------|--------------------------|
| 10 Passage             | 80 Storeroom             |
| 42 Privacy             | 84 Storeroom w/ deadbolt |
| 42I Privacy, indicator | 170 Dummy, surface*      |
| 45 Entry               | 171 Dummy, thru-bolt*    |
| 50 Office              | 172 Dummy, back-to-back  |
| 56 Dormitory           |                          |
| 70 Classroom           |                          |

(\* Sold in pairs.)

- Lever Styles** A–Apollo, R–Circa, C–Cornell, D–Dartmouth, G–Glasgow, L–Linea, S–Stanford, F–The Flat, T–Strata

- Knob Styles** K–Kent

- Finish** 15–Satin nickel, 19–Matte black, 26D–Satin chrome
- Other finishes available by special order*

DM	45	L	-	SQ	F	26D
SERIES	FUNCTION	HAND <sup>1)</sup>	TRIM	STYLE	FINISH	

(1) L–LEFT R–RIGHT

## SELECTION GUIDE

SERIES	TRIM	STYLE**	FUNCTION <sup>1</sup>	FINISH <sup>1</sup>	/CASE
DM	S, SQ, E, E2, E3	ALL	10 Passage	15, 19, 26D	6
DM	S, SQ, E, E2, E3	ALL	42 Privacy, with deadbolt	15, 19, 26D	6
DM	E	ALL	42I Privacy indicator, with deadbolt <sup>2</sup> ↔	15, 19, 26D	6
DM	S, SQ, E, E2, E3	ALL	45 Entry, with deadbolt ↔	15, 19, 26D	6
DM	S, SQ, E, E2, E3	ALL	50 Office ↔	15, 19, 26D	6
DM	S, SQ, E, E2, E3	ALL	56 Dormitory, with deadbolt ↔	15, 19, 26D	6
DM	S, SQ, E, E2, E3	ALL	70 Classroom ↔	15, 19, 26D	6
DM	S, SQ, E, E2, E3	ALL	80* Storeroom ↔	15, 19, 26D	6
DM	S, SQ, E, E2, E3	ALL	84* Storeroom, with deadbolt ↔	15, 19, 26D	6
DM	S, SQ	ALL	170 Dummy, single (surface mount)	15, 19, 26D	6
DM	S, SQ	ALL	171 Dummy, single (thru-bolt)	15, 19, 26D	6
DM	S, SQ, E, E2, E3	ALL	172 Dummy, back-to-back	15, 19, 26D	6

(1) OTHER FINISHES AND FUNCTIONS AVAILABLE, MINIMUM ORDER QUANTITIES AND/OR ADDITIONAL DELIVERY TIMES MAY BE REQUIRED – PLEASE CONTACT

(2) FOR DETAILS ABOUT ESCUTCHEON WITH OCCUPANCY INDICATOR - PLEASE CONTACT

↔ KEYED FUNCTION; FULL KEYING SERVICES AVAILABLE – PLEASE CONTACT (\*) ONE-SIDED INSTALLATION MODEL AVAILABLE (\*\*) XT / INTERSECT NOT AVAILABLE WITH ESCUTCHEON

## LEVERS & KNOBS

A–Apollo

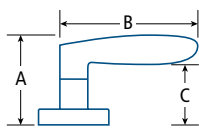

C–Cornell

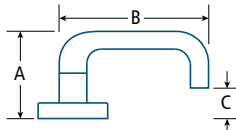

D–Dartmouth

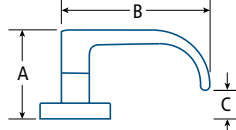

F–The Flat

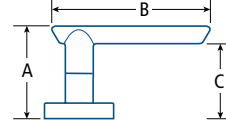

G–Glasgow

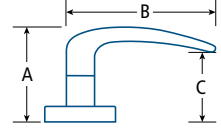

L–Linea

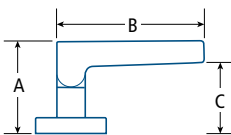

R–Circa

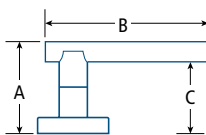

S–Stanford

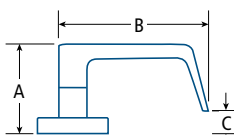

T–Strata

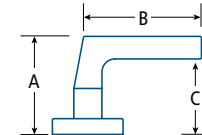

K–Kent

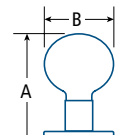

STYLE	A	B	C <sup>1</sup>
A–Apollo*	3 <sup>1</sup> / <sub>16</sub> (78)	4 <sup>5</sup> / <sub>8</sub> (116)	2 <sup>1</sup> / <sub>16</sub> (53)
C–Cornell	2 <sup>7</sup> / <sub>8</sub> (73)	5 <sup>5</sup> / <sub>16</sub> (134)	<sup>5</sup> / <sub>8</sub> (16)
D–Dartmouth	2 <sup>7</sup> / <sub>16</sub> (61.5)	5 <sup>7</sup> / <sub>8</sub> (149)	1 <sup>1</sup> / <sub>16</sub> (17)
F–The Flat	2 <sup>7</sup> / <sub>8</sub> (73)	5 <sup>1</sup> / <sub>2</sub> (139.7)	2 <sup>3</sup> / <sub>16</sub> (55.5)
G–Glasgow	2 <sup>7</sup> / <sub>8</sub> (73)	5 <sup>1</sup> / <sub>16</sub> (128)	2 <sup>1</sup> / <sub>16</sub> (52)

IN (MM) (1) ALL ROSES AND ESCUTCHEONS ARE 12.7 (1/2) THICK

STYLE	A	B	C <sup>1</sup>
L–Linea	2 <sup>13</sup> / <sub>16</sub> (71.4)	5 (127)	1 <sup>15</sup> / <sub>16</sub> (48.4)
R–Circa	2 <sup>9</sup> / <sub>16</sub> (65.5)	5 <sup>1</sup> / <sub>2</sub> (139.7)	1 <sup>7</sup> / <sub>8</sub> (47)
S–Stanford	2 <sup>9</sup> / <sub>16</sub> (65.5)	5 <sup>1</sup> / <sub>16</sub> (128)	<sup>9</sup> / <sub>16</sub> (14)
T–Strata	3 <sup>1</sup> / <sub>8</sub> (79.4)	5 <sup>5</sup> / <sub>8</sub> (130.2)	2 <sup>1</sup> / <sub>8</sub> (54)
K–Kent	2 <sup>7</sup> / <sub>16</sub> (61.5)	∅ 2 (50.8)	—

(\*) HANDED LEVER, NOT FIELD REVERSIBLE,

(\*\*) SECTIONAL ONLY, NOT AVAILABLE WITH ESCUTCHEON



# LOCK TRIMS

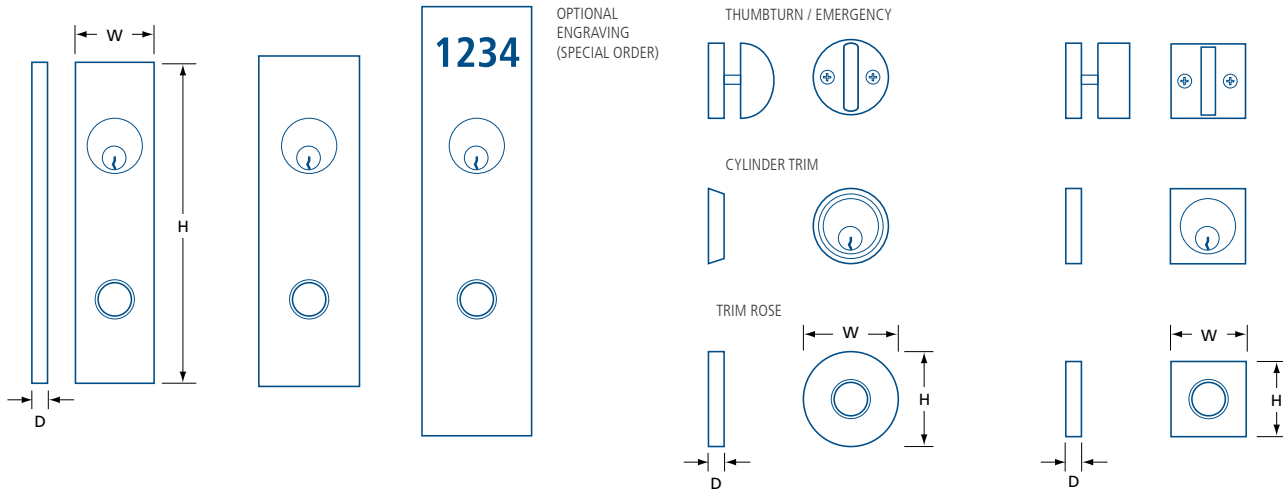

	ESCUTCHEON TRIM			SECTIONAL ROUND			SECTIONAL SQUARE		
TRIM	E	E2	E3	S			SQ		
Description	Regular escutcheon	Wide escutcheon	Large escutcheon	Round rose	Cylinder trim	Thumbturn	Square rose	Cylinder trim	Thumbturn
Width (W)	2 (50)	2 1/2 (64)	2 3/4 (70)	ø 2 3/8 (60)	1 13/16 (46)	1 3/4 (44.4)	1 7/8 (48)	1 7/8 (47.6)	1 7/8 (47.6)
Height (H)	8 1/16 (205)	8 1/4 (210)	10 3/4 (273)	—	1 13/16 (46)	1 3/4 (44.4)	1 7/8 (48)	1 7/8 (47.6)	1 7/8 (47.6)
Depth (D)	1/2 (12.7)	1/2 (12.7)	1/2 (12.7)	1/2 (12.7)	7/16 (11.1)	3/16 (4.7)	1/2 (12.7)	3/8 (9.5)	3/8 (9.5)
Material	Brass	Brass	Brass	Brass	Brass	Brass	Brass	Brass	Brass

IN (MM) (1)OPTIONAL ENGRAVING AVAILABLE—PLEASE CONTACT

# DIMENSIONS

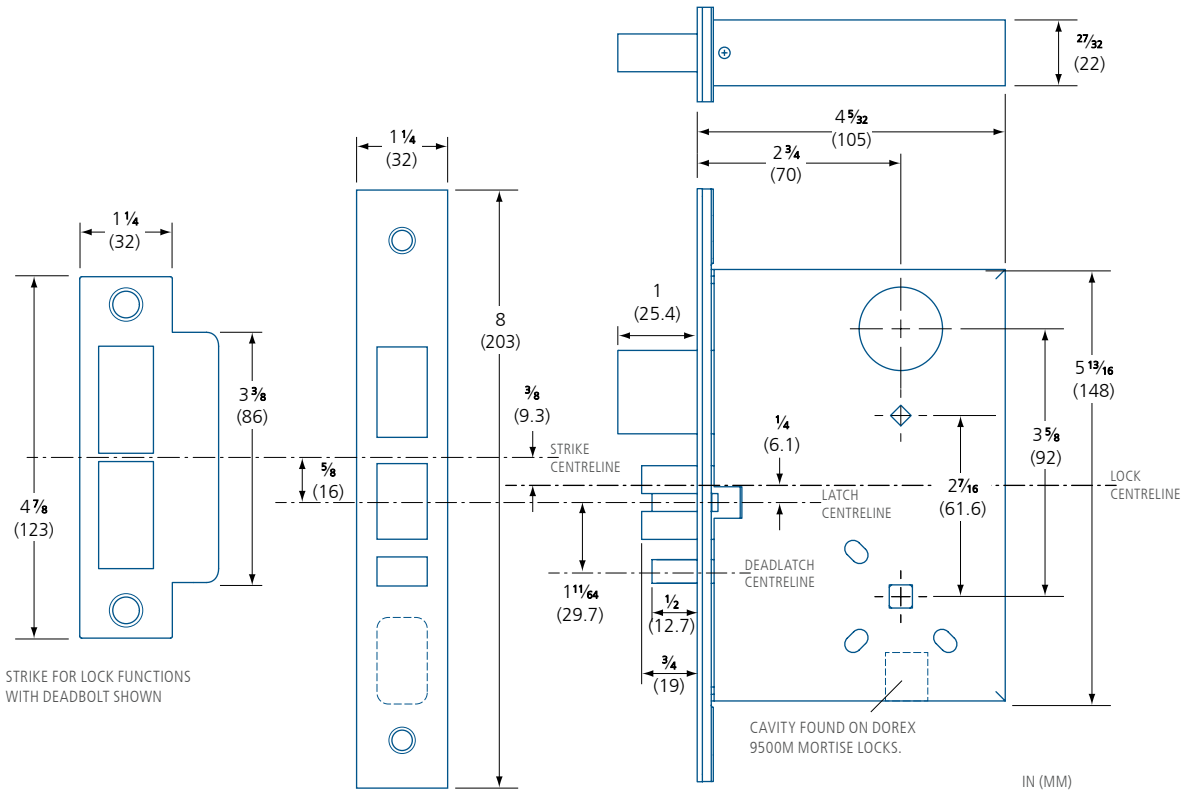

MUST BE INSTALLED ON A DOOR WITH A SOLID LOCK STILE WIDTH OF AT LEAST 5" (127 MM) OR WITH APPROPRIATE REINFORCEMENT.

⚠ WHEN USED WITH ELECTRIC STRIKE PLEASE REQUEST ADDITIONAL INFORMATION.

## PARTS & ACCESSORIES



**DM45X-PS**  
Replacement strike for 1 $\frac{3}{4}$ " (45) thick door.  
(Functions 42, 45, 56, 84)



**DM80X-PS**  
Replacement strike for 1 $\frac{3}{4}$ " (45) thick door.  
(Functions 10, 50, 70, 80)



**DM42X-PE**  
Mortise lock emergency privacy key; round.  
Includes plate and screws.  
Finish: 15, 19, 26D



**DM42X-PES**  
Mortise lock emergency privacy key; square.  
Includes plate and screws.  
Finish: 15, 19, 26D



**DM45X-PT**  
Mortise lock thumbturn; round. Mounting screws included.  
Finish: 15, 19, 26D



**DM45X-PTS**  
Mortise lock thumbturn; square. Mounting screws included.  
Finish: 15, 19, 26D



**DM00X-PPRVI**  
Sectional occupancy indicator. Includes round interior/exterior trims for use with privacy (42) function. For 1 $\frac{3}{4}$ " (44.5) thick wood door. Mounting hardware included. Finish: 15, 26D



**DM00X-PPRVIQ**  
Sectional occupancy indicator. Includes square interior/exterior trims for use with privacy (42) function. For 1 $\frac{3}{4}$ " (44.5) thick wood door. Mounting hardware included. Finish: 15, 26D



**DM00X-PPRVI-ECYL**  
Sectional keyed occupancy indicator. Includes round interior/exterior trims for use with keyed functions 45, 56, or 84. For 1 $\frac{3}{4}$ " (44.5) thick wood door. Mounting hardware and DM00X-ECYL cylinder with 2 keys included. Finish: 15, 26D



**DM00X-PPRVIQ-ECYL**  
Sectional keyed occupancy indicator. Includes square interior/exterior trims for use with keyed functions 45, 46, or 84. For 1 $\frac{3}{4}$ " (44.5) thick wood door. Mounting hardware and DM00X-ECYL cylinder with 2 keys included. Finish: 15, 26D



**DM45X-PR**  
Mortise cylinder collar with spring; round.  
1 $\frac{1}{16}$ " x  $\frac{3}{8}$ " ( $\varnothing$ 43 x 9)  
Finish: 15, 19, 26D



**DM45X-PRS**  
Mortise cylinder collar with spring; square.  
1 $\frac{7}{8}$ " x 1 $\frac{7}{8}$ " x  $\frac{3}{8}$ " (48 x 48 x 9)  
Finish: 15, 19, 26D



**DM00X-PSCYL**

- 1 $\frac{1}{8}$ " (28.6) 5-pin (drilled 6) brass mortise cylinder; Schlage "C" with 2 keys.
- For sectional installations on 1 $\frac{3}{4}$ " (45) thick doors.
- Includes DM00X-PCAM.
- Finish: 15, 19, 26D

**DM00X-PECYL**

- 1 $\frac{1}{4}$ " (31.8) 5-pin (drilled 6) brass mortise cylinder; Schlage "C" with 2 keys.
- For escutcheon installations on 1 $\frac{3}{4}$ " (45) thick doors.
- Includes DM00X-PCAM.
- Finish: 15, 19, 26D



**DM00X-PCAM**  
Replacement mortise cylinder cam, with screws

NOTE: OTHER CYLINDERS MAY REQUIRE A DIFFERENT CAM. PLEASE CONTACT IF USING A DIFFERENT CYLINDER. OTHER CAMS SOLD SEPARATELY.



**DM00X-PKDT225**  
Installation kit for 2–2 $\frac{1}{4}$ " (51–57) thick doors.

- Includes extended emergency thumbturn, spindle, springs, strike and mounting hardware for sectional or escutcheon trim.
- Mortise cylinder NOT INCLUDED.

*Please contact for details.*





\*SHOWN WITH OPTIONAL CYLINDER & COLLARS

- Certifications**
- Conforms to ANSI/BHMA A156.36, Grade 1
  - cULus listed, 3hr fire-rating
  - 5 Year limited warranty

**Door Thickness** • 1¼–2" (44.5–51 mm)

**Handing** • Non-handed

**Backset** • 2¾" (70 mm)

**Deadbolt** • Solid bolt  
• 1" (25.4 mm) throw

**Faceplate** • 1¼ x 5⅞" (31.5 x 142 mm)  
• Square corners

**Strike** • 1⅞ x 3½" (28.9 x 88.9 mm)  
• Square corners  
• Metal dust-box included

**Trim** • Cylinder collar and thumbturn available  
• Round or square styles available

*Sold separately, please contact for details*

**Chassis** • Function 64: concealed mounting  
*All other functions: exposed mounting*

**Cylinder** • Conventional and high security mortise cylinders available  
• Small format interchangeable core (SFIC) mortise housing available (less core)  
*Sold separately, please contact for details*

**Functions** 51 Single cylinder with thumbturn  
55 Thumbturn only  
60 Double cylinder  
64 Cylinder only<sup>1</sup>

*(1) For use in rooms with more than one exit*

**Finish<sup>1</sup>** 15–Satin nickel; 19–Matte black;  
26D–Satin chrome

*Other finishes available by special order  
(1) DMDBL strike and faceplate are 26D.  
Trims are available in 15, 19, or 26D.*

DMDBL  
SERIES

CONFIGURED TO ORDER – PLEASE CONTACT YOUR LOCAL SALES REPRESENTATIVE FOR DETAILS.

## DIMENSIONS

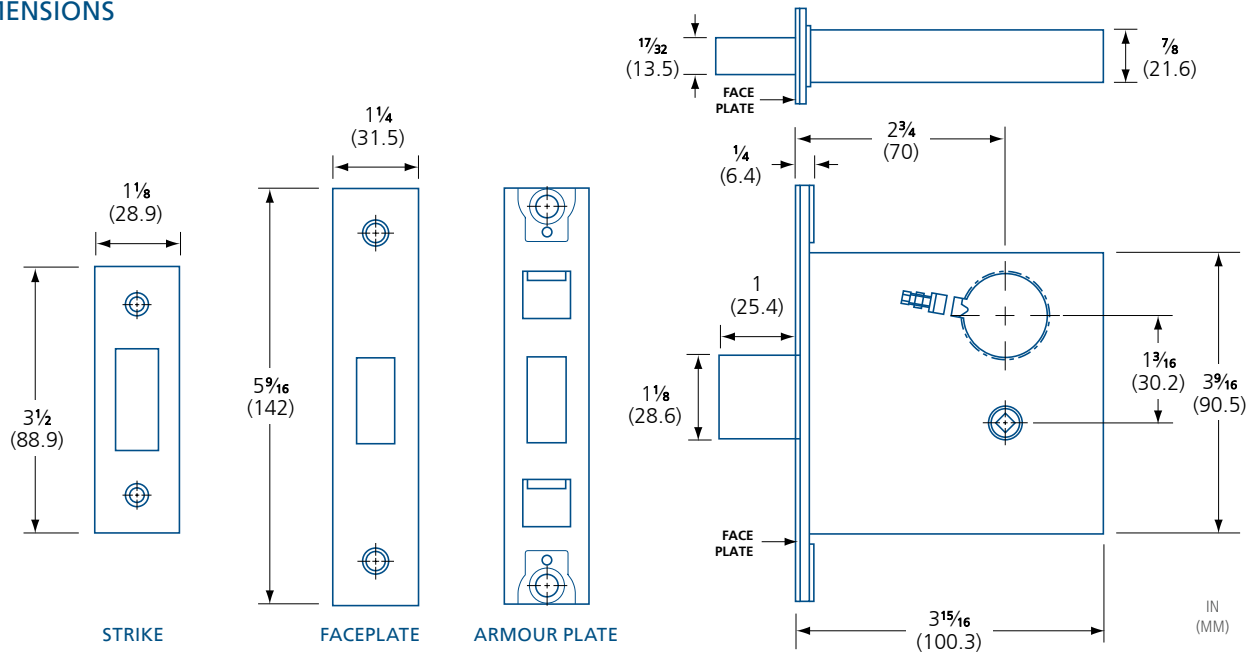

## PARTS & ACCESSORIES



**DM45X-PR**  
Mortise cylinder collar with spring; round.  
Ø 1 1/16 x 3/8" (43x9 mm)  
Finish: 15, 19, 26D



**DM45X-PRS**  
Mortise cylinder collar with spring; square.  
1 7/8 x 1 7/8 x 3/8" (48x48x9 mm)  
Finish: 15, 19, 26D



**DM00X-PSCYL**

- 1 1/8" (28.6 mm) 5-pin (drilled 6) brass mortise cylinder; Schlage "C" with 2 keys.
- For installations on 1 3/4" (45 mm) thick doors.
- Includes DM00X-PCAM.
- Finish: 15, 19, 26D

**DM00X-PECYL**

- 1 1/4" (31.8 mm) 5-pin (drilled 6) brass mortise cylinder; Schlage "C" with 2 keys.
- For installations on 2" (51 mm) thick doors
- Includes DM00X-PCAM.
- Finish: 15, 19, 26D



**DM00X-PCAM**  
Replacement mortise cylinder cam, with screws.

NOTE: OTHER CYLINDERS MAY REQUIRE A DIFFERENT CAM. PLEASE CONTACT IF USING A DIFFERENT CYLINDER. OTHER CAMS SOLD SEPARATELY.



**DM45X-PT**  
Mortise lock thumbturn; round. Mounting screws included. Finish: 15, 19, 26D



**DM45X-PTS**  
Mortise lock thumbturn; square. Mounting screws included. Finish: 15, 19, 26D



**DM00X-PPRVI**  
Occupancy indicator. Includes round interior/exterior trims for use with function 55. For 1 3/4" (44.5 mm) thick wood door. Mounting hardware included. Finish: 15, 26D



**DM00X-PPRVIQ**  
Occupancy indicator. Includes square interior/exterior trims for use with function 55. For 1 3/4" (44.5 mm) thick wood door. Mounting hardware included. Finish: 15, 26D



**DM00X-PPRVI-ECYL**  
Keyed occupancy indicator. Includes round interior/exterior trims for use with keyed function 51. For 1 3/4" (44.5 mm) thick wood door. Mounting hardware and DM00X-ECYL Cylinder with 2 keys included. Finish: 15, 26D



**DM00X-PPRVIQ-ECYL**  
Keyed occupancy indicator. Includes round interior/exterior trims for use with keyed function 51. For 1 3/4" (44.5 mm) thick wood door. Mounting hardware and DM00X-ECYL Cylinder with 2 keys included. Finish: 15, 26D



# TECNICA DESIGN

DOREX



## Mortise Lock Option

All TECNICA DESIGN levers are available with the DOREX DM premium mortise lock for maximum security, 3-hour fire-rating and Grade 1 performance. Excellent for suite, office or home entry and available with a wide variety of functions, trims and escutcheon sizes.

See page 01.070 or speak with your local representative for ordering, product or specification details.



## Interconnected Lock Option

The LINEA lever is available as a premium interconnected lock. The DOREX T2 IL series interconnected tubular lockset combines modern style, security and durability. Recommended as suite entry door locks in multi-unit residential applications. The T2IL offers 3 hour fire-rating and simultaneous retraction of both latch and deadbolt provides easy, panic-proof exiting.

See page 01.032 or speak with your local representative for ordering, product or specification details.



## Cylindrical Lock Option

TECNICA DESIGN's The Flat lever is available as a Grade 2 quality, 3hr fire-rated, commercial cylindrical lock. Ideal for multi-unit buildings requiring a stylish lever that offers common commercial functions, and can handle the wear and tear of frequent use.

See page 01.021 or speak with your local representative for ordering, product or specification details.



## Levers

- Modern lever styles ideal for contemporary styled homes and residential applications
- Privacy function with auto-release
- Concealed mounting screws
- Available with square or round rose
- All lever styles available with magnetic latches and strikes for seamless, minimalist installations



- Conforms to ANSI/BHMA Grade 3
- Meets ADA requirements
- 20 Minute fire-rating when installed with optional listed fire can\*
- Lifetime mechanical warranty
- 10-year limited finish warranty

- Non-handed, zinc die-cast levers
- For doors 1 $\frac{3}{8}$ –1 $\frac{3}{4}$ " (35–44.5 mm) thick
- Extension kit for 2 $\frac{1}{4}$ " (57 mm) thick doors available (#TDK100TE)
- Fits standard 2 $\frac{1}{8}$ " (54 mm) door preparation with 1" (25.4 mm) edge bore
- Stainless steel tubular spring latch with adjustable 2 $\frac{3}{8}$ –2 $\frac{3}{4}$ " (60–70 mm) backset
- Mortised faceplate with square corners, convertible to drive-in
- Galvanized steel interior mechanism
- Full-lip strike with round corners included.
- Concealed mounting screws

(\* ) Firecan kit must be ordered in conjunction with lockset, not available separately. For use on fire labelled, wood doors only.

- Available with magnetic tubular latch and invisible strike
- ASA strike for metal door frames available
- Other faceplate options available

### AVAILABLE FUNCTIONS

- 10 Passage
- 42 Privacy, with auto-release
- 5 Dummy, single (surface / thru-bolt)<sup>1</sup>
- 3 Handleset interior trim<sup>2</sup>

(1) Can be installed back-to-back using thru-bolts  
(2) For use with Tecnica Design entry handlesets



LINEA – ROUND  
SATIN NICKEL



© DOREX



THE FLAT – SQUARE  
SATIN NICKEL



NEW



STRATA – SQUARE  
SATIN NICKEL



CIRCA  
SATIN NICKEL



## SELECTION GUIDE

100	10	FT	S	15	M	—
SERIES	FUNCTION <sup>1</sup>	STYLE	ROSE <sup>2</sup>	FINISH	LATCH <sup>3</sup>	OPTION <sup>4</sup>

(1) OMIT FUNCTION WHEN ORDERING DUMMY OR HANDLESET TRIM OPTION (2) BLANK : ROUND  
 S: SQUARE (3) M: MORTISE V: DRIVE-IN (4) -3: HANDLE TRIM -5: DUMMY



Firecan kit must be ordered in conjunction with lock, not available separately. For fire labelled wood doors ONLY.

		10B OIL RUB. BRONZE	11P ANTIQU BRONZE	15 SATIN NICKEL	15A ANTIQU NICKEL	19 MATTE BLACK	26 POLISH CHROME	26D SATIN CHROME	3 POLISH BRASS	32D SATIN S.STEEL	4 SATIN BRASS	5 ANTIQU BRASS	V3* POLISH BRASS	/CASE†
CIRCA	CT			•		•	•	•						10
LINEA	LT			•		•	•	•						10
THE FLAT	FT			•		•	•	•						10
STRATA	ST			•		•	•	•						10

OTHER FINISHES AVAILABLE, MINIMUM ORDER QUANTITIES AND/OR ADDITIONAL DELIVERY TIMES MAY BE REQUIRED – PLEASE CONTACT (\*) LIFETIME FINISH WARRANTY (†) DUMMY ARE 20/CASE

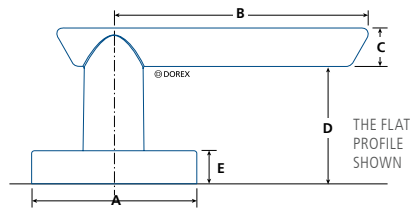

	A	B	C	D	E
CIRCA CT	2 <sup>9</sup> / <sub>16</sub> (64.5)	4 (101.6)	1 <sup>9</sup> / <sub>32</sub> (15)	1 <sup>3</sup> / <sub>4</sub> (45)	1/2 (12.7)
LINEA LT / LTS	2 <sup>9</sup> / <sub>16</sub> (64.5)	4 (101.6)	2 <sup>5</sup> / <sub>32</sub> (20)	1 <sup>9</sup> / <sub>16</sub> (40)	1/2 (12.7)
THE FLAT FT / FTS	2 <sup>9</sup> / <sub>16</sub> (64.5)	4 (101.6)	3 <sup>7</sup> / <sub>64</sub> (14.7)	1 <sup>25</sup> / <sub>32</sub> (45.3)	1/2 (12.7)
STRATA ST / STS	2 <sup>9</sup> / <sub>16</sub> (64.5)	4 <sup>9</sup> / <sub>16</sub> (115.9)	7/8 (22)	1 <sup>5</sup> / <sub>8</sub> (42)	1/2 (12.7)

IN (MM)

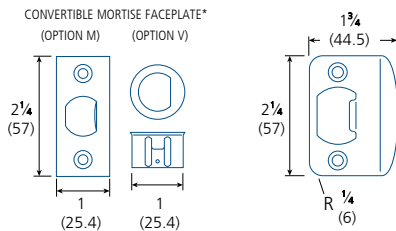

(\*) Regardless of option ordered, the part required to convert from one option to the other is included.

## Magnetic Latch Option



All TECNICA DESIGN levers are available with magnetic latches and strikes providing the perfect solution for ultra-quiet applications. With no protruding bolt or strike lip, these latches offer a clean, minimalist look for those looking to create unique, flush-to-wall, and snag-free installations free of unsightly latch bolts or strike lips.



- Strike and latch use strong neodymium (rare earth) magnets
- Ergonomic 30-degree activation
- Requires the same tools and preparation as classic tubular latches
- Pair with invisible hinges for unique flush-to-wall door installations
- Not for use in fire-rated applications
- Only available for Passage or Privacy (with auto-release) functions

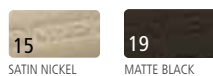

M6	100	10	FT	S	15	M
BACKSET <sup>1</sup>	SERIES	FUNCTION	STYLE	ROSE <sup>2</sup>	FINISH	LATCH

(1) M6: 2<sup>3</sup>/<sub>4</sub>IN (60MM) FIXED BACKSET, M7: 2<sup>3</sup>/<sub>4</sub>IN (70MM) FIXED BACKSET  
 (2) 10: PASSAGE, 42: PRIVACY (3) BLANK : ROUND, S: SQUARE



## Entry Handlesets

- Reliable, quality modern entry handlesets for residential homes
- Concealed mounting screws
- Includes Linea interior lever and matching round or square thumbturn
- Interior lever can be swapped with any other Tecnica Design lever<sup>1</sup>

(1) Availability may vary, please contact your local Dorex representative.

- Conforms to ANSI/BHMA Grade 3
- 25-year mechanical warranty
- 5-year limited finish warranty
- Non-handed, zinc die-cast exterior trim
- For doors 1¾–2¼" (44.5–57 mm) thick
- Fits standard 2⅝" (54 mm) door preparation with 1" (25.4 mm) edge bore
- Steel tubular spring latch with adjustable 2⅞–2¾" (60–70 mm) backset.
- Steel 1" (25.4 mm) deadbolt latch with hardened steel security pin and adjustable 2⅞–2¾" (60–70 mm) backset
- Mortised faceplate with square corners, convertible to drive-in
- Galvanized steel interior mechanism
- Weiser 5-pin brass cylinder in steel housing with 2 keys
- Full-lip strike and deadbolt strike for wood door frames included

### AVAILABLE FUNCTIONS

**T401** Entry  
(single cylinder w/ thumbturn)

G3

25  
YEAR

## SELECTION GUIDE

T401	PT	LTS	15	KD	W
SERIES	STYLE <sup>1</sup>	TRIM <sup>2</sup>	FINISH	KEYING	LATCH

(1) AR: ARCO; DT: DELTA; PT: PLATO (2) LTS: LINEA-SQUARE

	10B OIL RUB. BRONZE	11P ANTIQU BRONZE	15 SATIN NICKEL	15A ANTIQU NICKEL	19 MATTE BLACK	26 POLISHED CHROME	26D SATIN CHROME	3 POLISHED BRASS	32D SATIN S.STEEL	4 SATIN BRASS	C5 ANTIQU BRASS	V3* POLISHED BRASS	/CASE
<b>ARCO</b>	AR		●		●	●	●						6
<b>DELTA</b>	DT		●		●	●	●						6
<b>PLATO</b>	PT		●		●	●	●						6

OTHER FINISHES AVAILABLE, MINIMUM ORDER QUANTITIES AND/OR ADDITIONAL DELIVERY TIMES MAY BE REQUIRED – PLEASE CONTACT (\*) LIFETIME FINISH WARRANTY

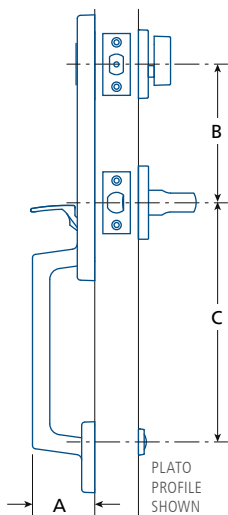

	A	B	C
<b>ARCO</b>	2 <sup>11</sup> / <sub>16</sub>	5 <sup>1</sup>	8 <sup>3</sup> / <sub>4</sub> – 10 <sup>3</sup> / <sub>8</sub> <sup>2</sup>
AR	(68)	(127)	(222 – 264)
<b>DELTA</b>	2 <sup>1</sup> / <sub>8</sub>	5 <sup>1</sup>	8 <sup>13</sup> / <sub>32</sub>
DT	(54)	(127)	(214)
<b>PLATO</b>	2 <sup>11</sup> / <sub>16</sub>	5 <sup>1</sup> / <sub>2</sub>	8 <sup>3</sup> / <sub>4</sub> – 10 <sup>3</sup> / <sub>8</sub> <sup>2</sup>
PT	(68)	(140)	(222 – 264)

IN (MM) (1) RECOMMENDED DISTANCE (2) ADJUSTABLE

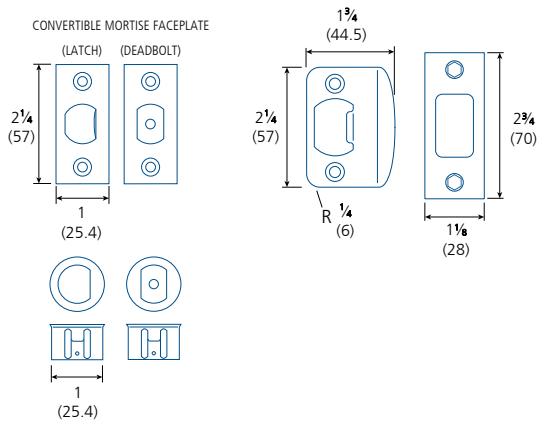

## Deadbolt Locks

- TECNICA DESIGN deadbolts are a blend of aesthetics, security, and dependability
- ANSI/BHMA Grade 3 Security, excellent for suite entry doors and offices
- Concealed mounting screws
- Can be keyed to insert into any key system.
- Can accommodate CX5 High Security cylinders for enhanced security



GIRO  
SATIN NICKEL



- Certified ANSI/BHMA Grade 3.
- 20 Minute fire-rating when installed with optional listed fire can\*
- 25-year mechanical warranty
- 5-year limited finish warranty.

- For doors 1 $\frac{3}{8}$ –1 $\frac{3}{4}$ " (35–44.5 mm) thick
- Extension kit for 2 $\frac{1}{4}$ " (57 mm) thick doors available (#TLA85052)
- Fits standard 2 $\frac{1}{8}$ " (54 mm) door preparation with 1" (25.4 mm) edge bore
- Steel 1" (25.4 mm) deadbolt latch with hardened steel security pin and adjustable 2 $\frac{3}{8}$ –2 $\frac{3}{4}$ " (60–70 mm) backset
- Mortised faceplate with square corners, convertible to drive-in
- Galvanized steel interior mechanism.
- Removable brass cylinder in steel housing with 2 keys
- Security strikes for wood and metal door frames included

(\* *Firecan kit must be ordered in conjunction with lock, not available separately. For use on fire labelled, wood doors only.*

- Keying options available – including CX5 high security cylinders
- Other faceplate options available



QUADRA  
SATIN NICKEL



### AVAILABLE FUNCTIONS

- 51 Single cylinder with thumbturn



## SELECTION GUIDE

201	51	TR	15	KD	M
SERIES <sup>1</sup>	FUNCTION	STYLE	FINISH	KEYING <sup>2</sup>	LATCH <sup>3</sup>
(1) 201: WEISER 5-PIN 202: SCHLAGE 6-PIN KEYWAY (2) KA: KEYED ALIKE KD: KEYED DIFFERENT					
(3) M: MORTISE V: DRIVE-IN ONLY					



Firecan kit must be ordered in conjunction with deadbolt, not available separately. For fire labelled wood doors ONLY.

Full keying services available – please contact for details

STYLE	10B OIL RUB. BRONZE	11P ANTIQUE BRONZE	15 SATIN NICKEL	15A ANTIQUE NICKEL	19 MATTE BLACK	26 POLISHED CHROME	26D SATIN CHROME	32D SATIN S.STEEL	3 POLISHED BRASS	4 SATIN BRASS	5 ANTIQUE BRASS	V3* POLISHED BRASS	/CASE
GIRO	TR		•		•	•	•						24
QUADRA	TS		•		•	•	•						24

OTHER FINISHES AVAILABLE, MINIMUM ORDER QUANTITIES AND/OR ADDITIONAL DELIVERY TIMES MAY BE REQUIRED – PLEASE CONTACT (\*) LIFETIME FINISH WARRANTY

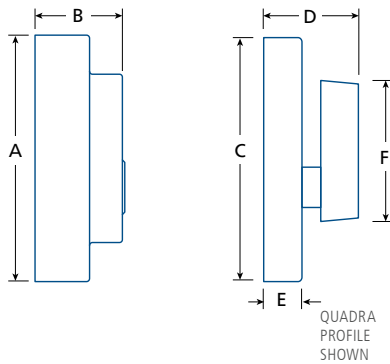

	A	B	C	D	E	F
GIRO TR	∅ 2½ (64)	15/16 (23.8)	2½ (64)	1 (25.4)	3/8 (9)	17/8 (47)
QUADRA TS	∅ 29/16 (64.5)	15/16 (23.8)	29/16 (64.5)	1 (25.4)	3/8 (9)	1¾ (45)

IN (MM)

CONVERTIBLE MORTISE FACEPLATE\*  
(OPTION M) (OPTION V)

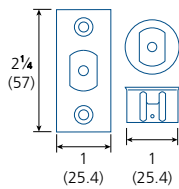

SECURITY STRIKES  
(WOOD / METAL)

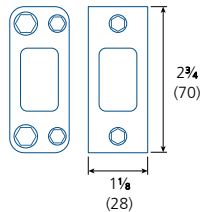

(\*) Regardless of option ordered, the part required to convert from one option to the other is included.

## PARTS & ACCESSORIES



**200T-SWA**  
Replacement thumbturn setscrew,  
spring washer, and hex key.





## MAGNETIC LATCHES

Tecnica Design magnetic latches provide the perfect solution for ultra-quiet residential applications. With no protruding bolt or strike lip, these latches offer a clean, minimalist look to homeowners looking to create unique flush-to-wall installations free of unsightly strikes or bolts.

# Magnetic Latches

All TECNICA DESIGN levers are available with magnetic latches and strikes providing the perfect solution for ultra-quiet applications. With no protruding bolt or strike lip, these latches offer a clean, minimalist look for those looking to create unique, flush-to-wall, and snag-free installations free of unsightly latch bolts or strike lips.

- Strike and latch use strong neodymium (rare earth) magnets.
- Ergonomic 30-degree activation.
- Requires the same tools and door preparation as classic tubular latches.
- Pair with invisible hinges for unique flush-to-wall door installations.
- Not for use in fire-rated applications. Cannot be used with a DOREX firecan kit.
- Only available for Passage or Privacy (with auto-release) functions.



## HOW DOREX MAGNETIC LATCHES WORK

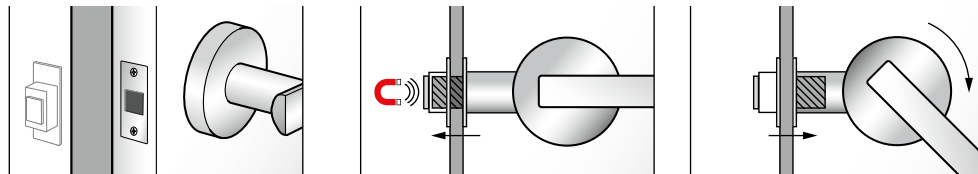

**WHEN OPEN**, the latch is held retracted while the door is open for a clean, minimalist look. Since the strike has no lip, it is not visible.

**WHEN CLOSING**, a rare-earth magnet will instantly and quietly pull the latch into the strike to latch the door securely.

**WHEN USING** the lever, the latch will quietly retract and be held magnetically. Even when the lever is released, the latch will remain retracted in its housing.

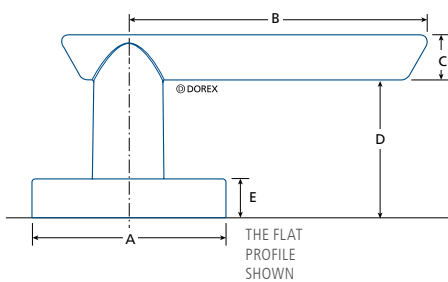

	A	B	C	D	E
<b>CIRCA</b> CT	∅ 2 <sup>9</sup> / <sub>16</sub> (64.5)	4 (101.6)	1 <sup>9</sup> / <sub>32</sub> (15)	1 <sup>3</sup> / <sub>4</sub> (45)	1/2 (12.7)
<b>LINEA</b> LT / LTS	∅ 2 <sup>9</sup> / <sub>16</sub> (64.5)	4 (101.6)	2 <sup>5</sup> / <sub>32</sub> (20)	1 <sup>9</sup> / <sub>16</sub> (40)	1/2 (12.7)
<b>THE FLAT</b> FT / FTS	∅ 2 <sup>9</sup> / <sub>16</sub> (64.5)	4 (101.6)	3 <sup>7</sup> / <sub>64</sub> (14.7)	1 <sup>25</sup> / <sub>32</sub> (45.3)	1/2 (12.7)
<b>STRATA</b> ST / STS	2 <sup>9</sup> / <sub>16</sub> (64.5)	4 <sup>9</sup> / <sub>16</sub> (115.9)	7/8 (22)	1 <sup>5</sup> / <sub>8</sub> (42)	1/2 (12.7)

IN (MM)

## SELECTION GUIDE

	10B OIL RUB. BRONZE	11P ANTIQUE BRONZE	15 SATIN NICKEL	15A ANTIQUE NICKEL	19 MATTE BLACK	26 POLISHED CHROME	26D SATIN CHROME	3 POLISHED BRASS	32D SATIN S.STEEL	4 SATIN BRASS	5 ANTIQUE BRASS	V3* POLISHED BRASS	/CASE
<b>CIRCA</b>	CT		•		•								10
<b>LINEA</b>	LT		•		•								10
<b>THE FLAT</b>	FT		•		•								10
<b>STRATA</b>	ST		•		•								10

OTHER FINISHES AVAILABLE, MINIMUM ORDER QUANTITIES AND/OR ADDITIONAL DELIVERY TIMES MAY BE REQUIRED – PLEASE CONTACT (\*) LIFETIME FINISH WARRANTY

M6	100	10	FT	S	15	M
BACKSET <sup>1</sup>	SERIES	FUNCTION <sup>2</sup>	STYLE	ROSE <sup>3</sup>	FINISH	LATCH

(1) M6: 2<sup>3</sup>/<sub>16</sub>IN (60MM) FIXED BACKSET, M7: 2<sup>3</sup>/<sub>16</sub>IN (70MM) FIXED BACKSET  
 (2) 10: PASSAGE, 42: PRIVACY (3) BLANK : ROUND, S: SQUARE

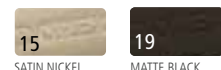

# DOREX®

# Signature





## Levers

- Classic, modern lever styles that can fit into any decor
- Non-handed and handed lever styles
- Privacy function with auto-release
- Keyed entry function available
- Can be keyed to insert into any key system



- Conforms to ANSI/BHMA Grade 3
- 20 Minute fire-rating when installed with optional listed fire can\*
- 25 year mechanical warranty
- 5 year limited finish warranty
- Non-handed or handed, zinc die-cast lever
- For doors 1 $\frac{3}{8}$ –1 $\frac{3}{4}$ " (35–44.5 mm) thick
- Fits standard 2 $\frac{1}{8}$ " (54 mm) door preparation with 1" (25.4 mm) edge bore
- Stainless steel tubular spring latch with adjustable 2 $\frac{3}{8}$ –2 $\frac{3}{4}$ " (60–70 mm) backset
- Mortise faceplate with square corners, convertible to drive-in
- Galvanized steel interior mechanism
- Entry models include removable 5-pin cylinder with 2 keys
- Full-lip strike with round corners included

(\* Firecan kit must be ordered in conjunction with lockset, not available separately. For use on fire labelled, solid wood doors only.

- Keying options available
- Other faceplate options available
- 5" (127 mm) backset latch available

### AVAILABLE FUNCTIONS

- 10 Passage
- 42 Privacy, with auto-release
- 51 Entry ↔
- 1 Single Dummy (surface)
- 2 Single Dummy (thru-bolt)
- 3 Handleset trim\*

(\* Handleset trim includes lever spring latch)



## SELECTION GUIDE

101	51	AT	C15	KD	M	RH	—
SERIES <sup>1</sup>	FUNCTION	STYLE	FINISH	KEYING	LATCH <sup>2</sup>	HAND <sup>3</sup>	OPTION <sup>4</sup>
(1) 100: NO KEYWAY; 101: WEISER; 102: SCHLAGE KEYWAY; OMIT FUNCTION AND USE 100 WHEN ORDERING DUMMY OR TRIM (2) M: MORTISE W: DRIVE-IN (3) ATHENA OR DUMMY APOLLO, INDICATE RH: RIGHT HAND, LH: LEFT HAND (4) -1: DUMMY, SINGLE -2: DUMMY, THRU-BOLT -3: TRIM							



Firecan kit must be ordered in conjunction with lock, not available separately. For fire labelled wood doors ONLY.

Full keying services available – please contact for details.

	C10B	C11P	C15	C15A	C19	C26D	C3	C32D	C4	C5	V3**	/CASE†
	OIL RUB. BRONZE	ANTIQUÉ BRONZE	SATIN NICKEL	ANTIQUÉ NICKEL	MATTE BLACK	SATIN CHROME	POLISHED BRASS	SATIN S.STEEL	SATIN BRASS	ANTIQUÉ BRASS	POLISHED BRASS	
<b>ATHENA</b> (REVERSIBLE)*	AT	●	●	●	●	●						20
<b>APOLLO</b> (REVERSIBLE)*	AP	●	●			●						20
<b>CAMBRIDGE</b>	CB	●	●	●		●						20
<b>ESCORT</b>	ES					●	●					20
<b>HAWTHORNE</b>	HW					●						20
<b>JUNO</b>	JN		●		●	●						20
<b>MANHATTAN</b>	M			●		●	●	●				20

OTHER FINISHES AVAILABLE, MINIMUM ORDER QUANTITIES AND/OR ADDITIONAL DELIVERY TIMES MAY BE REQUIRED – PLEASE CONTACT (\*) RIGHT HAND, FIELD REVERSIBLE. DUMMY LEVERS ARE NOT REVERSIBLE, PLEASE INDICATE HANDING. (\*\*) LIFETIME FINISH WARRANTY (†) DUMMY ARE 20/CASE

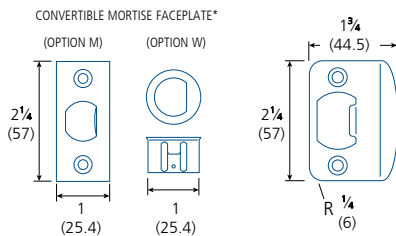
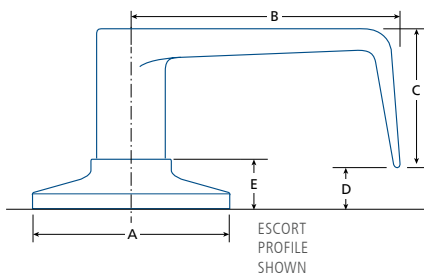

(\*) Regardless of option ordered, the part required to convert from one option to the other is included.

	A	B	C	D	E
<b>ATHENA</b>	2 9/16	3 15/16	1	1 9/16	1 9/32
AT	(65)	(100)	(25)	(40)	(15)
<b>APOLLO</b>	2 9/16	4 1/8	3/4	1 3/8	1 9/32
AP	(65)	(105)	(20)	(35)	(15)
<b>CAMBRIDGE</b>	2 9/16	3 15/16	5/16	1 31/32	1 9/32
CB	(65)	(100)	(8)	(50)	(15)
<b>ESCORT</b>	2 9/16	3 15/16	1 1/2	1 5/32	1 9/32
ES	(65)	(100)	(38)	(12)	(15)
<b>HAWTHORNE</b>	2 9/16	3 15/16	3/8	1 31/32	1 9/32
HW	(65)	(100)	(9.5)	(50)	(15)
<b>JUNO</b>	2 9/16	4 1/8	1 1/16	1 9/16	1 9/32
JN	(65)	(105)	(18)	(40)	(15)
<b>MANHATTAN</b>	2 9/16	3 15/32	5/16	1 31/32	1 9/32
M	(65)	(88)	(8)	(50)	(15)

IN (MM)



## Knobs

- Classic, knob styles that can fit into any decor
- Privacy function with auto-release
- Keyed entry function available
- Can be keyed to insert into any key system



BALA  
SATIN NICKEL

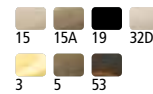

EGLINGTON  
ANTIQUÉ NICKEL



- Conforms to ANSI/BHMA Grade 3
- 20 Minute fire-rating when installed with optional listed firecan kit\*
- 25 year mechanical warranty
- 5 year limited finish warranty
- Steel knob and rose
- For doors 1 $\frac{3}{8}$ –1 $\frac{3}{4}$ " (35–44.5 mm) thick
- Fits standard 2 $\frac{1}{8}$ " (54 mm) door preparation with 1" (25.4 mm) edge bore
- Stainless steel spring latch with adjustable backset
- Mortise faceplate with square corners, convertible to drive-in
- Galvanized steel interior mechanism
- Entry models include removable 5-pin cylinder with 2 keys
- Full-lip strike with round corners included

(\* ) Firecan kit must be ordered in conjunction with lockset, not available separately. For use on fire labelled, solid wood doors only.

- Keying options available
- Other faceplate options available
- 5" (127 mm) backset latch available

### AVAILABLE FUNCTIONS

- 10 Passage
- 42 Privacy, with auto-release
- 51 Entry ↔
- 1 Single Dummy (surface)
- 2 Single Dummy (thru-bolt)
- 3 Handleset trim



## SELECTION GUIDE

101	51	B	C15	KD	M	-
SERIES <sup>1</sup>	FUNCTION	STYLE	FINISH	KEYING	LATCH <sup>2</sup>	OPTION <sup>3</sup>
(1) 100: NO KEYPWAY 101: WEISER 102: SCHLAGE KEYWAY; OMIT FUNCTION AND USE 100 WHEN ORDERING DUMMY OR TRIM (2) M: MORTISE W: DRIVE-IN (3) -1: DUMMY, SINGLE -2: DUMMY, THRU-BOLT -3: TRIM						



Firecan kit must be ordered in conjunction with lock, not available separately. For fire labelled wood doors ONLY.

Full keying services available – please contact for details

		C10B OIL RUB. BRONZE	C11P ANTIQU BRONZE	C15 SATIN NICKEL	C15A ANTIQU NICKEL	C19 MATTE BLACK	C26 POLISHED CHROME	C26D SATIN CHROME	C3 POLISHED BRASS	C32D SATIN S.STEEL	C4 SATIN BRASS	C5 ANTIQU BRASS	53 ANT. / POL. BRASS	/CASE
<b>BALA</b>	B			•	•	•			•	•		•	•	20
<b>EGLINGTON</b>	EG			•	•	•		•						20

OTHER FINISHES AVAILABLE, MINIMUM ORDER QUANTITIES AND/OR ADDITIONAL DELIVERY TIMES MAY BE REQUIRED – PLEASE CONTACT

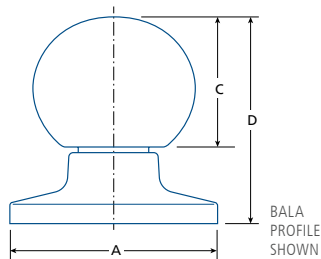

	A	B	C	D
<b>BALA</b> B	2 <sup>9</sup> / <sub>16</sub> (65)	2 (51)	1 <sup>1</sup> / <sub>16</sub> (40)	2 <sup>1</sup> / <sub>2</sub> (63.5)
<b>EGLINGTON</b> EG	2 <sup>9</sup> / <sub>16</sub> (65)	1 <sup>3</sup> / <sub>8</sub> (60)	1 <sup>1</sup> / <sub>16</sub> (40)	2 <sup>1</sup> / <sub>2</sub> (63.5)

IN (MM)

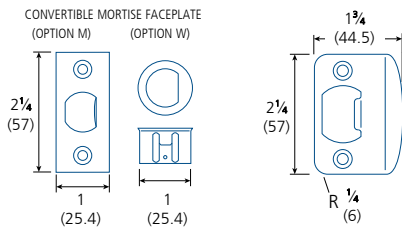

(\* Regardless of option ordered, the part required to convert from one option to the other is included.



## Entry Handlesets

- Reliable, quality classic entry handlesets for residential homes
- Non-handed
- Includes Bala interior knob
- Interior knob can be swapped with any other Signature lever or knob<sup>1</sup>
- Can be keyed to insert into any key system
- Can accommodate CX5 High Security cylinders for enhanced security

(1) Availability may vary, please contact your local Dorex representative.

- Conforms to ANSI/BHMA Grade 3
- 20 Minute fire-rating when installed with optional listed firecan kits\*
- 25 year mechanical warranty
- 5 year limited finish warranty
- Non-handed, zinc die-cast exterior trim
- For doors 1 $\frac{3}{8}$ –2 $\frac{1}{4}$ " (44.5–57 mm) thick
- Fits standard 2 $\frac{1}{8}$ " (54 mm) door preparation with 1" (25.4 mm) edge bore
- Stainless steel tubular spring latch with adjustable 2 $\frac{3}{8}$ –2 $\frac{3}{4}$ " (60–70 mm) backset
- Brass 1" (25.4 mm) deadbolt latch with hardened steel security pin and adjustable 2 $\frac{3}{8}$ –2 $\frac{3}{4}$ " (60–70 mm) backset
- 4-way mortise faceplate with square corners, convertible to drive-in
- Galvanized steel interior mechanism
- Removable 5-pin brass cylinder in steel housing with 2 keys
- Full-lip strike and security strike for wood door frames (round corners) included

(\*) Firecan kits must be ordered in conjunction with handleset, not available separately. For use on fire labelled, solid wood doors only.

### AVAILABLE FUNCTIONS

- Entry ↔
- Dummy – available



**CAPRI**  
SATIN NICKEL  
11P 15 15A 19



**MAYFAIR**  
MATTE BLACK  
11P 15 15A 19  
26 26D 3 5



**IMPERIAL**  
ANTIQUÉ NICKEL  
11P 15 15A



**BIARRITZ**  
ANTIQUÉ BRASS  
15A 5

## SELECTION GUIDE

401	BI	B	C15	KD	W	-
SERIES¹	STYLE	TRIM	FINISH	KEYING	LATCH	OPTION²
(1) 400: NO KEYWAY 401: WEISER 402: SCHLAGE KEYWAY USE 400 WHEN ORDERING DUMMY						
(2) DUM: DUMMY						



Fire-cans (2) must be ordered in conjunction with lock, not available separately. For fire labelled wood doors ONLY.

GATE LATCH AVAILABLE, must be ordered in conjunction with handleset – please contact for details.

Full keying services available – please contact for details

	C10B OIL RUB. BRONZE	C11P ANTIQUÉ BRONZE	C15 SATIN NICKEL	C15A ANTIQUÉ NICKEL	C19 MATTE BLACK	C26 POLISHED CHROME	C26D SATIN CHROME	C3 POLISHED BRASS	C32D SATIN S.STEEL	C4 SATIN BRASS	C5 ANTIQUÉ BRASS	V3* POLISHED BRASS	/CASE
BIARRITZ	BI			•							•	•	6
CAPRI	CA	•	•	•	•								6
IMPERIAL	IM	•	•	•									6
MAYFAIR	MA	•	•	•	•	•	•	•			•	•	6

OTHER FINISHES AVAILABLE, MINIMUM ORDER QUANTITIES AND/OR ADDITIONAL DELIVERY TIMES MAY BE REQUIRED – PLEASE CONTACT (\*) LIFETIME FINISH WARRANTY

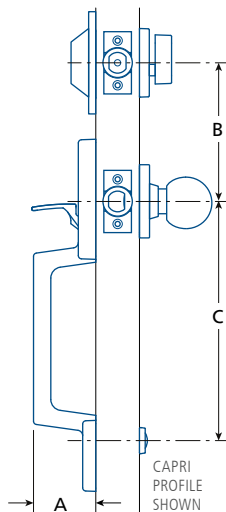

	A	B*	C
BIARRITZ BI	2 <sup>3</sup> / <sub>8</sub> (60)	5 (127)	8 <sup>13</sup> / <sub>32</sub> (214)
CAPRI CA	2 <sup>5</sup> / <sub>32</sub> (55)	5 (127)	8 <sup>13</sup> / <sub>32</sub> (214)
IMPERIAL IM	2 <sup>9</sup> / <sub>16</sub> (65)	5 (127)	8 <sup>13</sup> / <sub>32</sub> (214)
MAYFAIR MA	2 <sup>7</sup> / <sub>16</sub> (62)	5 (127)	8 <sup>13</sup> / <sub>32</sub> (214)

IN (MM) (\*) RECOMMENDED DISTANCE

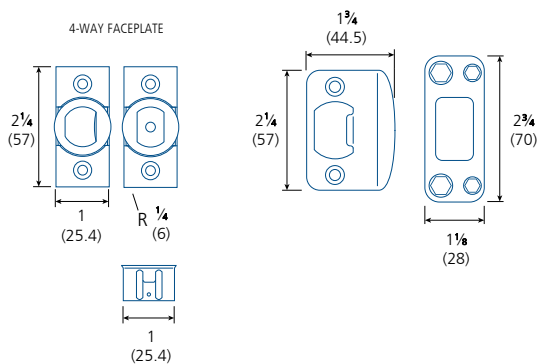

## Deadbolt Locks

- ANSI/BHMA Grade 3 Security, excellent for suite entry doors and offices
- Can be keyed to insert into any key system
- Can accommodate CX5 High Security cylinders for enhanced security



- Conforms to ANSI/BHMA Grade 3
- 20 Minute fire-rating available
- 25 year mechanical warranty
- 5 year limited finish warranty
- For doors 1 3/8–1 3/4" (35–44.5 mm) thick
- Extension kit for 2 1/4" (57 mm) thick doors available (#TLA85052)
- Fits standard 2 1/8" (54 mm) door preparation with 1" (25.4 mm) edge bore
- Steel or brass 1" (25.4 mm) deadbolt latch with hardened steel security pin and adjustable 2 3/8–2 3/4" (60–70 mm) backset
- Mortise faceplate with square corners, convertible to drive-in
- Galvanized steel interior mechanism
- Removable brass cylinder in steel housing with 2 keys
- Rotating exterior collar for enhanced protection against physical attack
- Security strikes for wood and steel frames included
- Other faceplate options available



200 SERIES  
SATIN NICKEL  
SINGLE CYLINDER



200 SERIES  
SATIN NICKEL  
THUMB-TURN ONLY

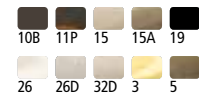

200 SERIES  
SATIN STAINLESS STEEL  
DOUBLE CYLINDER



### AVAILABLE FUNCTIONS

- 51 Single cylinder with thumb-turn ➔
- 55 One-side, thumb-turn only
- 57 Thumb-turn with exterior plate
- 60 Double cylinder ➔

## SELECTION GUIDE

F	201	51	C15	KD	M
RATING <sup>1</sup>	SERIES <sup>2</sup>	FUNCTION	FINISH	KEYING <sup>3</sup>	LATCH <sup>4</sup>

(1) LEAVE BLANK FOR NON-RATED MODEL (2) **200**: NO KEYWAY **201**: WEISER 5-PIN **202**: SCHLAGE KEYWAY 6-PIN USE 200 WHEN ORDERING FUNCTIONS 55 OR 57 (2) **KA**: KEYED ALIKE **KD**: KEYED DIFFERENT (3) **M**: CONVERTIBLE MORTISE



For fire labelled wood doors ONLY. For details, consult local building codes and/or local authority having jurisdiction (AHJ). Separate firecan kit may be required for some finishes.

Full keying services available – please contact for details

	C10B	C11P	C15	C15A	C19	C26	C26D	C32D	C3	C4	C5	C53	V3*	/CASE
	OIL RUB. BRONZE	ANTIQUE BRONZE	SATIN NICKEL	ANTIQUE NICKEL	MATTE BLACK	POLISHED CHROME	SATIN CHROME	SATIN S.STEEL	POLISHED BRASS	SATIN BRASS	ANTIQUE BRASS	ANT. / POL. BRASS	POLISHED BRASS	
<b>200 SERIES</b>	●	●	●	●	●	●	●	●	●	●	●	●	●	24

OTHER FINISHES AVAILABLE, MINIMUM ORDER QUANTITIES AND/OR ADDITIONAL DELIVERY TIMES MAY BE REQUIRED – PLEASE CONTACT (\*) LIFETIME FINISH WARRANTY

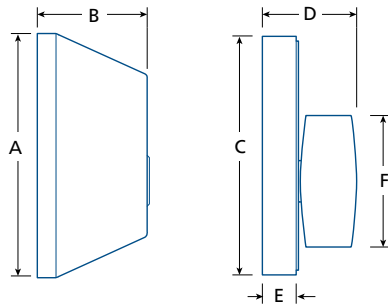

	A	B	C	D	E	F
<b>200 SERIES</b>	∅ 2 <sup>9</sup> / <sub>16</sub> (65)	1 <sup>1</sup> / <sub>8</sub> (29)	∅ 2 <sup>1</sup> / <sub>2</sub> (63)	1 (25.4)	3 <sup>3</sup> / <sub>8</sub> (9)	1 <sup>3</sup> / <sub>8</sub> (35)

IN (MM)

CONVERTIBLE MORTISE FACEPLATE (OPTION M)

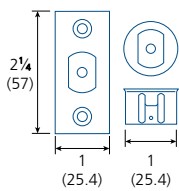

SECURITY STRIKES (WOOD / METAL)

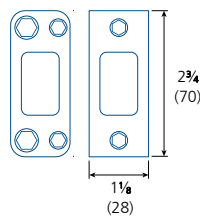

**DOREX®**

**METRO**

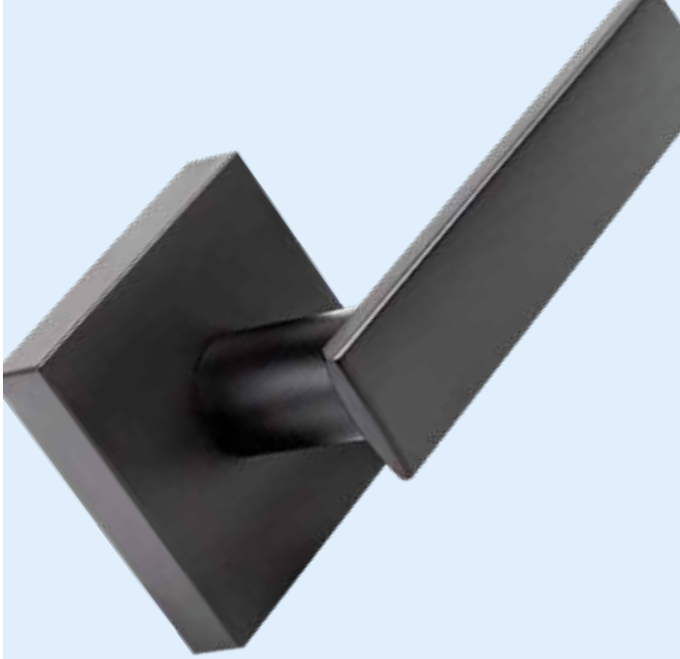

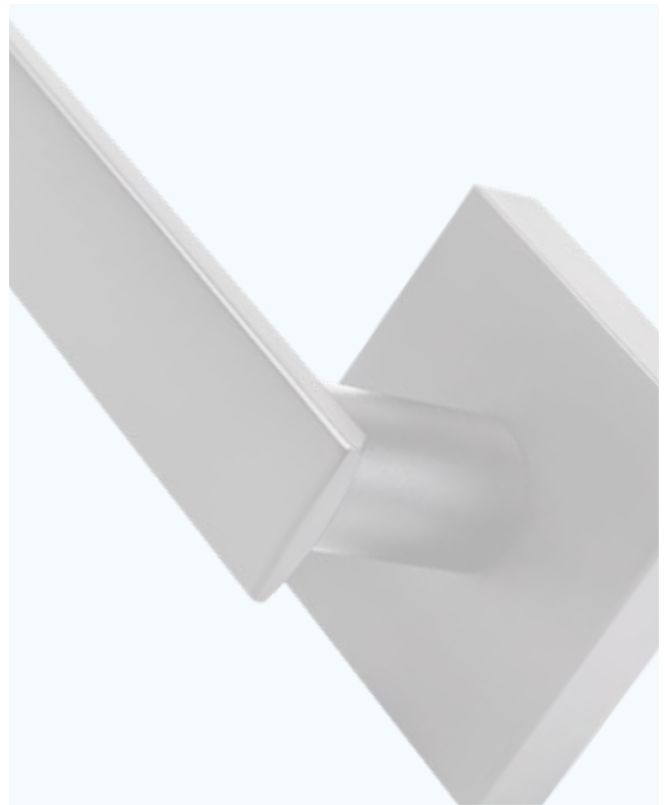

## Levers

- All new collection of urban inspired, contemporary levers
- Non-handed and handed lever styles
- Privacy function with auto-release

- 1 year mechanical warranty
- 1 year limited finish warranty
- Non-handed or handed, zinc die-cast lever
- For doors  $1\frac{3}{8}$ – $1\frac{3}{4}$ " (35–44.5 mm) thick
- Fits standard  $2\frac{1}{8}$ " (54 mm) door preparation with 1" (25.4 mm) edge bore
- Steel tubular spring latch with adjustable  $2\frac{3}{8}$ – $2\frac{3}{4}$ " (60–70 mm) backset
- 4-Way, mortise faceplate with square corners, convertible to drive-in
- Full-lip strike with round corners included
- Other faceplate options available

### AVAILABLE FUNCTIONS

- 10 Passage
- 51 Entry (Livia only)
- 42 Privacy, with auto-release
- 17 Single Dummy (surface)



**NERO**  
MATTE BLACK



ROSE



**LIVIA**  
ANTIQUÉ NICKEL



ROSE



**CASSIUS**  
SATIN CHROME



## SELECTION GUIDE

V2X	42	Q	S	L	-	15	M
SERIES	FUNCTION	STYLE	ROSE <sup>1</sup>	HAND <sup>2</sup>	FINISH	LATCH <sup>3</sup>	

(1) BLANK: ROUND S: SQUARE (2) FOR CASSIUS INDICATE R: RIGHT HAND, L: LEFT HAND  
 (3) BLANK: 4-WAY; D: DRIVE-IN; M: FIXED MORTISE (SQ CORNER); MR: FIXED MORTISE (RND CORNER)

		10B OIL RUB. BRONZE	11P ANTIQUÉ BRONZE	15 SATIN NICKEL	15A ANTIQUÉ NICKEL	19 MATTE BLACK	26 POLISHED CHROME	26D SATIN CHROME	3 POLISHED BRASS	32D SATIN S.STEEL	4 SATIN BRASS	5 ANTIQUÉ BRASS	/CASE†
LIVIA	L			●	●	●		●					24
NERO	N			●		●		●					24
CASSIUS (HANDED)	Q			●		●		●					24

OTHER FINISHES/OPTIONS AVAILABLE, MINIMUM ORDER QUANTITIES AND/OR ADDITIONAL DELIVERY TIMES MAY BE REQUIRED – PLEASE CONTACT

(†) DUMMY ARE 30/CASE

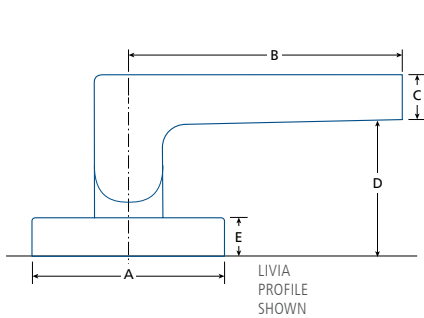

	A	B	C	D	E
LIVIA L / LS	∅ 2 <sup>9</sup> / <sub>16</sub> ∅ (65)	3 <sup>7</sup> / <sub>8</sub> (99.8)	3 <sup>4</sup> / <sub>4</sub> (19.5)	1 <sup>5</sup> / <sub>8</sub> (41)	1 <sup>7</sup> / <sub>32</sub> (13.5)
NERO N / NS	∅ 2 <sup>9</sup> / <sub>16</sub> ∅ (65)	4 <sup>1</sup> / <sub>16</sub> (103)	3 <sup>8</sup> / <sub>8</sub> (9.5)	2 (50.5)	1 <sup>7</sup> / <sub>32</sub> (13.5)
CASSIUS Q	∅ 2 <sup>9</sup> / <sub>16</sub> (65)	4 <sup>5</sup> / <sub>8</sub> (117)	2 <sup>9</sup> / <sub>32</sub> (23)	1 <sup>11</sup> / <sub>16</sub> (43.4)	1 <sup>7</sup> / <sub>32</sub> (13.5)

IN (MM)

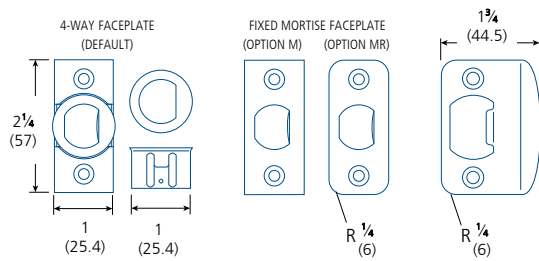

## Knobs

- Mid-century inspired, contemporary door knobs that can accommodate nearly any modern decor
- Privacy function with auto-release
- Keyed entry function available
- Round or square rose

- 1 year mechanical warranty
- 1 year limited finish warranty

- Non-handed, zinc die-cast knob
- For doors  $1\frac{3}{8}$ – $1\frac{3}{4}$ " (35–44.5 mm) thick
- Fits standard  $2\frac{1}{8}$ " (54 mm) door preparation with 1" (25.4 mm) edge bore
- Steel tubular spring latch with adjustable  $2\frac{3}{8}$ – $2\frac{3}{4}$ " (60–70 mm) backset
- 4-Way, mortise faceplate with square corners, convertible to drive-in
- Entry model includes 5-pin cylinder, Weiser keyway with 2 keys
- Full-lip strike with round corners included
- Other faceplate options available

### AVAILABLE FUNCTIONS

- 10 Passage
- 42 Privacy, with auto-release
- 51 Entry 
- 17 Single Dummy (surface)



GEMINI  
SATIN NICKEL



GEMINI  
SATIN NICKEL



## SELECTION GUIDE

<b>V3X</b>	<b>42</b>	<b>G</b>	<b>S</b>	<b>-</b>	<b>15</b>	<b>MR</b>
SERIES	FUNCTION	STYLE	ROSE <sup>1</sup>		FINISH	LATCH <sup>2</sup>

(1) LEAVE BLANK FOR ROUND ROSE (2) 4-WAY LATCH BY DEFAULT; **MR**: FIXED MORTISE (RND)

	<b>10B</b> OIL RUB. BRONZE	<b>11P</b> ANTIQU BRONZE	<b>15</b> SATIN NICKEL	<b>15A</b> ANTIQU NICKEL	<b>19</b> MATTE BLACK	<b>26D</b> SATIN CHROME	<b>3</b> POLISHED BRASS	<b>4</b> SATIN BRASS	<b>5</b> ANTIQU BRASS	<b>53</b> ANT. / POL. BRASS	/CASE†
<b>GEMINI</b>	G/GS		●		●						24*

OTHER FINISHES AVAILABLE, MINIMUM ORDER QUANTITIES AND/OR ADDITIONAL DELIVERY TIMES MAY BE REQUIRED – PLEASE CONTACT  
 (†) DUMMY ARE 30/CASE (\*) GEMINI ENTRY FUNCTION IS 12/CASE

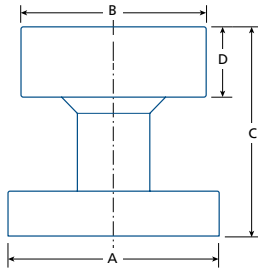

	A	B	C	D
<b>GEMINI</b>	∅ 2 <sup>9</sup> / <sub>16</sub>	2 <sup>1</sup> / <sub>4</sub>	2 <sup>9</sup> / <sub>16</sub>	7 <sup>7</sup> / <sub>8</sub>
G/GS	∅ (65)	(57)	(65)	(22)

IN (MM)

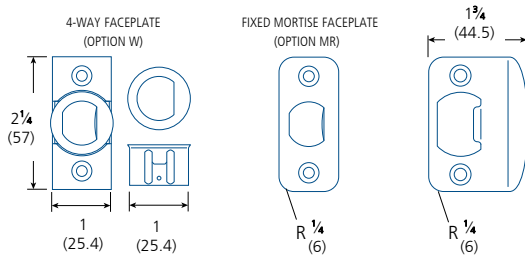

## Deadbolt Locks

- Contemporary deadbolt lock styles for home and property security



METRO SQUARE  
MATTE BLACK  
SINGLE CYLINDER



- 20 Minute fire-rating model available
- 1 year mechanical warranty
- 1 year limited finish warranty
- For doors 1 $\frac{3}{8}$ –1 $\frac{3}{4}$ " (35–44.5 mm) thick
- Extension kit for 2 $\frac{1}{4}$ " (57 mm) thick doors available (#B1-EXT)
- Fits standard 2 $\frac{1}{8}$ " (54 mm) door preparation with 1" (25.4 mm) edge bore
- Steel 1" (25.4 mm) deadbolt latch with hardened steel security pin and adjustable 2 $\frac{3}{8}$ –2 $\frac{3}{4}$ " (60–70 mm) backset
- Mortise faceplate with square corners, convertible to drive-in
- 5-pin cylinder, Weiser keyway with 2 keys
- Strike for wood door frames included
- Other faceplate options available
- 5-pin Schlage cylinder available

### AVAILABLE FUNCTIONS

- 51 Single cylinder with thumb-turn ➔

## SELECTION GUIDE

V11	51	-	S	-	15	KD	M
SERIES <sup>1</sup>	FUNCTION	STYLE <sup>2</sup>	FINISH	KEYING <sup>3</sup>	LATCH <sup>4</sup>		

(1) **V11**: WEISER 5-PIN; **V12**: SCHLAGE 5-PIN. (2) **S**: SQUARE (3) **KA**: KEYED ALIKE **KD**: KEYED DIFFERENT (4) **M**: CONVERTIBLE MORTISE **FM**: FIRE-RATED, FIXED MORTISE (SQ CORNER)



For fire labelled wood doors ONLY. To order, specify V12 Schlage series lock with FM latch.

STYLE	10B OIL RUB. BRONZE	11P ANTIQU BRONZE	15 SATIN NICKEL	15A ANTIQU NICKEL	19 MATTE BLACK	26 POLISHED CHROME	26D SATIN CHROME	3 POLISHED BRASS	32D SATIN S.STEEL	4 SATIN BRASS	5 ANTIQU BRASS	53 ANT. / POL. BRASS	/CASE
<b>METRO</b> SQUARE			•		•		•						24

OTHER FINISHES AVAILABLE, MINIMUM ORDER QUANTITIES AND/OR ADDITIONAL DELIVERY TIMES MAY BE REQUIRED – PLEASE CONTACT

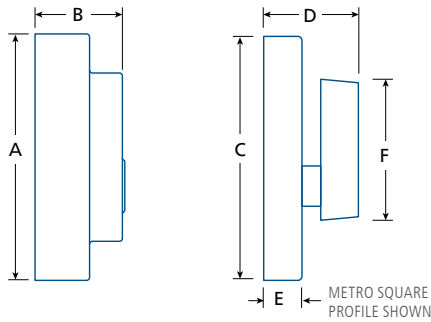

	A	B	C	D	E	F
<b>METRO</b> SQUARE	2 <sup>9</sup> / <sub>16</sub> (65)	3/4 (20)	2 <sup>1</sup> / <sub>2</sub> (63)	1 <sup>9</sup> / <sub>64</sub> (29)	3/8 (9)	1 <sup>3</sup> / <sub>4</sub> (44.5)
IN (MM)						

CONVERTIBLE FACEPLATE  
(OPTION M)

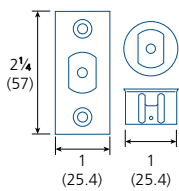

FIXED FACEPLATE  
(OPTION FM)

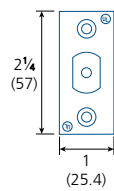

STRIKE

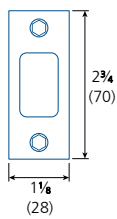

**DOREX<sup>®</sup>**

**BUILDER**



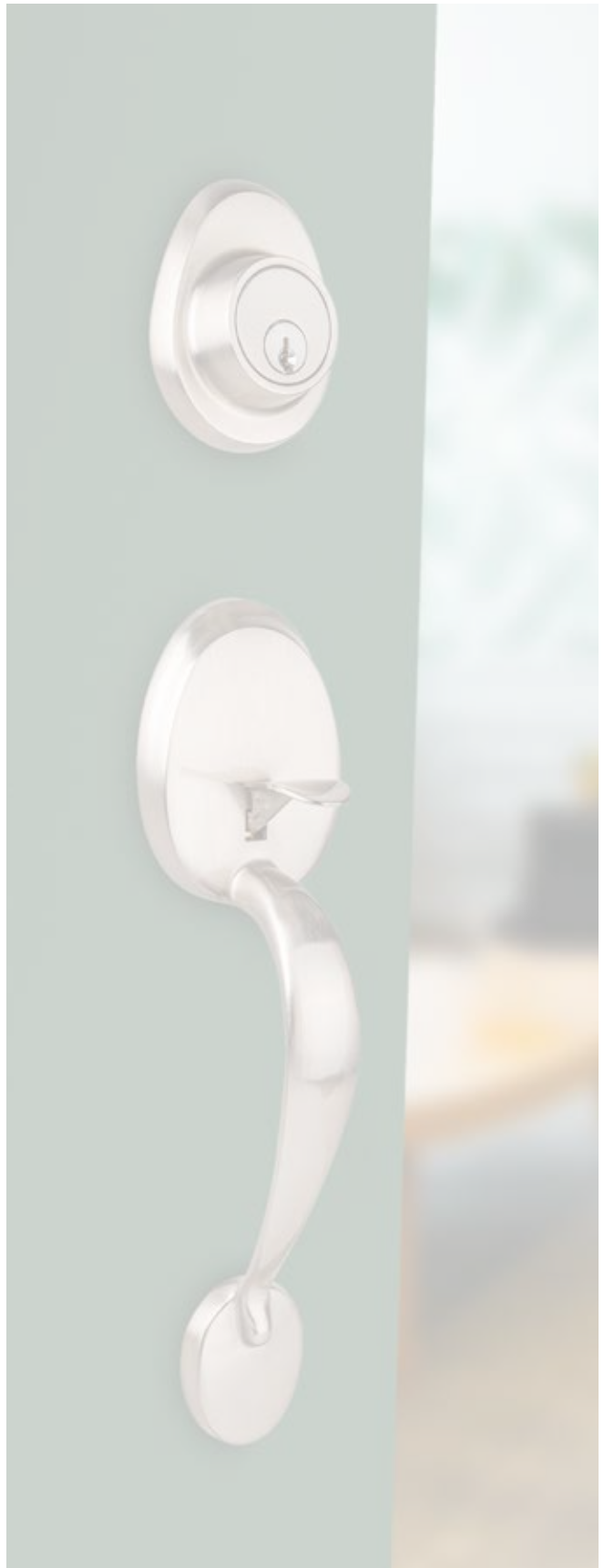

## Levers

- Contemporary lever styles for residential home construction professionals
- Keyed entry function available

- 1 Year mechanical warranty
- 1 Year limited finish warranty
- Non-handed zinc die-cast lever
- For doors 1 $\frac{3}{8}$ –1 $\frac{3}{4}$ " (35–44.5 mm) thick
- Fits standard 2 $\frac{1}{8}$ " (54 mm) door preparation with 1" (25.4 mm) edge bore
- Steel tubular spring latch with adjustable 2 $\frac{3}{8}$ –2 $\frac{3}{4}$ " (60–70 mm) backset
- 4-Way, mortise faceplate with square corners, convertible to drive-in
- Entry model includes 5-pin cylinder, Weiser keyway with 2 keys
- Full-lip strike with round corners included
- Other faceplate options available

### AVAILABLE FUNCTIONS

- 10 Passage
- 17 Dummy, single (surface)
- 42 Privacy
- 51 Entry ↔



EARL  
SATIN NICKEL



STRAIGHT  
MATTE BLACK

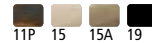

JULIA  
SATIN NICKEL



ROSE



## SELECTION GUIDE

<b>B2X</b>	<b>42</b>	<b>J</b>	<b>S</b>	<b>-</b>	<b>15</b>	<b>KD</b>	<b>M</b>
SERIES	FUNCTION	STYLE	ROSE <sup>2</sup>		FINISH	KEYING <sup>3</sup>	LATCH <sup>4</sup>

(2) BLANK: ROUND; S: SQUARE (3) KD: KEYED DIFFERENT (DEFAULT); KA: KEYED ALIKE  
 (4) BLANK: 4-WAY; M: FIXED MORTISE (SQ CORNER); MR: FIXED MORTISE (RND CORNER)

NOTE: ONLY THE STRAIGHT STYLE (S) IS AVAILABLE WITH KEYED ENTRY FUNCTION (S1).

		10B OIL RUB. BRONZE	11P ANTIQU BRONZE	15 SATIN NICKEL	15A ANTIQU NICKEL	19 MATTE BLACK	26 POLISH CHROME	26D SATIN CHROME	3 POLISH BRASS	32D SATIN S.STEEL	4 SATIN BRASS	5 ANTIQU BRASS	/CASE†
<b>EARL</b>	E			●				●					20
<b>JULIA</b>	J			●		●							20
<b>STRAIGHT</b>	S		●	●	●	●		●	●				20

OTHER FINISHES/OPTIONS AVAILABLE, MINIMUM ORDER QUANTITIES AND/OR ADDITIONAL DELIVERY TIMES MAY BE REQUIRED – PLEASE CONTACT

(†) DUMMY ARE 30/CASE

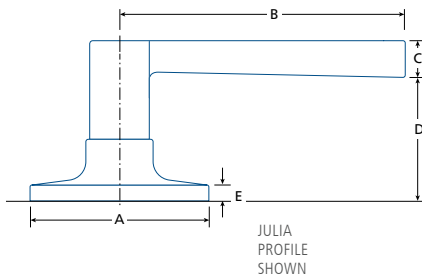

	A	B	C	D	E
<b>EARL</b> E	∅ 2 <sup>9</sup> / <sub>16</sub> (65)	3 <sup>1</sup> / <sub>2</sub> (89)	<sup>3</sup> / <sub>8</sub> (9.5)	1 <sup>3</sup> / <sub>8</sub> (35)	1 <sup>7</sup> / <sub>32</sub> (13.5)
<b>JULIA</b> J / JS	∅ 2 <sup>9</sup> / <sub>16</sub> (65)	4 <sup>7</sup> / <sub>16</sub> (112.5)	<sup>3</sup> / <sub>4</sub> (19)	1 <sup>1</sup> / <sub>2</sub> (38)	<sup>1</sup> / <sub>4</sub> (6.5)
<b>STRAIGHT</b> S	∅ 2 <sup>9</sup> / <sub>16</sub> (65)	3 <sup>3</sup> / <sub>4</sub> (95.3)	<sup>3</sup> / <sub>16</sub> (4.8)	2 (50.7)	<sup>1</sup> / <sub>4</sub> (6.5)

IN (MM)

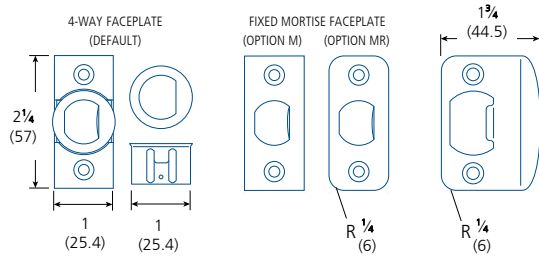

## Knobs

- Versatile classic door knobs for residential home construction professionals
- Keyed entry function available

- 1 Year mechanical warranty
- 1 Year limited finish warranty
- Non handed, steel knob
- For doors  $1\frac{3}{8}$ – $1\frac{3}{4}$ " (35–44.5 mm) thick
- Fits standard  $2\frac{1}{8}$ " (54 mm) door preparation with 1 (25.4 mm) edge bore
- Steel tubular spring latch with adjustable  $2\frac{3}{8}$ – $2\frac{3}{4}$ " (60–70 mm) backset
- 4-Way, mortise faceplate with square corners, convertible to drive-in
- Entry model includes 5-pin cylinder, Weiser keyway with 2 keys
- Full-lip strike with round corners included
- Other faceplate options available

### AVAILABLE FUNCTIONS

- 10 Passage
- 42 Privacy
- 51 Entry
- 17 Single Dummy (surface)



RONDO  
SATIN CHROME



RONDO  
SATIN CHROME

## SELECTION GUIDE

<b>B3X</b>	<b>51</b>	<b>R</b>	<b>-</b>	<b>15</b>	<b>KD</b>	<b>W</b>
SERIES	FUNCTION	STYLE	FINISH	KEYING <sup>1</sup>	LATCH <sup>2</sup>	

(1) **KD**: KEYED DIFFERENT; **KA**: KEYED ALIKE

(2) **W**: 4-WAY; **M**: FIXED MORTISE; **MR**: FIXED MORTISE (RND CORNER)

		<b>10B</b> OIL RUB. BRONZE	<b>11P</b> ANTIQUE BRONZE	<b>15</b> SATIN NICKEL	<b>15A</b> ANTIQUE NICKEL	<b>19</b> MATTE BLACK	<b>26D</b> SATIN CHROME	<b>3</b> POLISHED BRASS	<b>4</b> SATIN BRASS	<b>5</b> ANTIQUE BRASS	<b>53</b> ANT. / POL. BRASS	/CASE†
<b>RONDO</b>	R		●	●	●	●	●	●			●	30

OTHER FINISHES AVAILABLE, MINIMUM ORDER QUANTITIES AND/OR ADDITIONAL DELIVERY TIMES MAY BE REQUIRED – PLEASE CONTACT

(†) DUMMY ARE 60/CASE

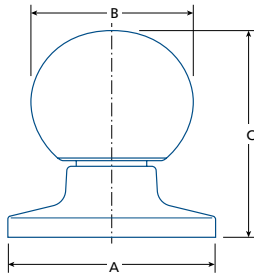

	$\varnothing A$	B	C
<b>RONDO</b>	$2\frac{9}{16}$	2	$2\frac{3}{4}$
R	(65)	(51)	(70)

IN (MM)

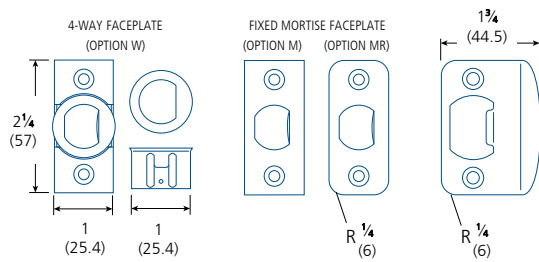

## Entry Handlesets

- Classic entry handlesets for residential home construction professionals
- Non-handed
- Includes interior knob

- 1 Year mechanical warranty
- 1 Year limited finish warranty

- Non-handed, zinc die-cast exterior trim
- For doors  $1\frac{3}{8}$ – $1\frac{3}{4}$ " (35–44.5 mm) thick
- Fits standard  $2\frac{1}{8}$ " (54 mm) door preparation with 1" (25.4 mm) edge bore
- Stainless steel tubular spring latch with adjustable  $2\frac{3}{8}$ – $2\frac{3}{4}$ " (60–70 mm) backset
- Steel 1" (25.4 mm) deadbolt latch with hardened steel security pin and adjustable  $2\frac{3}{8}$ – $2\frac{3}{4}$ " (60–70 mm) backset
- Mortised faceplate with square corners, convertible to drive-in
- 5-pin cylinder, Weiser keyway with 2 keys
- Full-lip strike and security strike for wood door frames (round corners) included

### AVAILABLE FUNCTIONS

- Entry ↔



## SELECTION GUIDE

30	1	CH	B	15	KD	W
SERIES	KEYWAY <sup>1</sup>	STYLE	TRIM	FINISH	KEYING <sup>2</sup>	LATCH <sup>3</sup>

(1) 1: WEISER (2) KD: KEYED DIFFERENT (3) W: MORTISE

		C10B OIL RUB. BRONZE	C11P ANTIQUÉ BRONZE	C15 SATIN NICKEL	C15A ANTIQUÉ NICKEL	C19 MATTE BLACK	C26 POLISHED CHROME	C26D SATIN CHROME	C3 POLISHED BRASS	C32D SATIN S.STEEL	C4 SATIN BRASS	C5 ANTIQUÉ BRASS	V3* POLISHED BRASS	/CASE
<b>CHÂTEAU</b>	CH		•	•	•	•		•						6
<b>LAURENTIAN</b>	LA			•		•								6
<b>MANOR</b>	MN		•	•	•	•		•	•					6

OTHER FINISHES AVAILABLE, MINIMUM ORDER QUANTITIES AND/OR ADDITIONAL DELIVERY TIMES MAY BE REQUIRED – PLEASE CONTACT (\*) LIFETIME FINISH WARRANTY

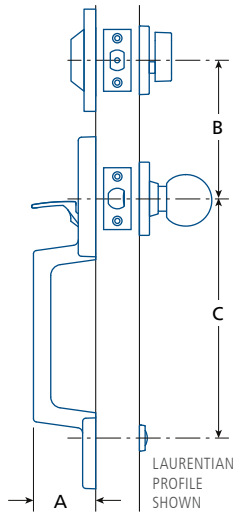

	A	B <sup>1</sup>	C <sup>2</sup>
<b>CHÂTEAU</b> CH	2 <sup>9</sup> / <sub>16</sub> (65)	5 (127)	8 <sup>7</sup> / <sub>16</sub> (214)
<b>LAURENTIAN</b> LA	2 <sup>3</sup> / <sub>8</sub> (60)	5 (127)	8 <sup>7</sup> / <sub>16</sub> <sup>(2)</sup> (214)
<b>MANOR</b> MN	2 <sup>3</sup> / <sub>8</sub> (60)	5 (127)	8 <sup>5</sup> / <sub>8</sub> (219)

IN (MM) (1) RECOMMENDED DISTANCE (2) DEFAULT DISTANCE, CAN BE ADJUSTED TO 8 5/8" (219MM) OR 9" (228MM)

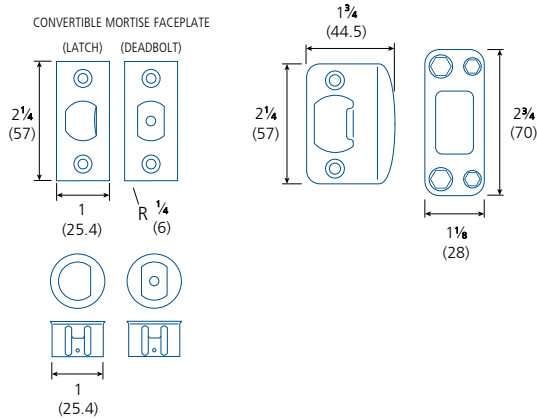

## Deadbolt Locks

- Classic deadbolt for home construction professionals

- 1 Year mechanical warranty
- 1 Year limited finish warranty
- For doors  $1\frac{3}{8}$ – $1\frac{3}{4}$ " (35–44.5 mm) thick
- Fits standard  $2\frac{1}{8}$ " (54 mm) door preparation with 1" (25.4 mm) edge bore
- Steel 1" (25.4 mm) deadbolt latch with hardened steel security pin and adjustable  $2\frac{3}{8}$ – $2\frac{3}{4}$ " (60–70 mm) backset
- 4-Way mortise faceplate with square corners, convertible to drive-in
- 5-pin cylinder, Weiser keyway with 2 keys
- Security strike for wood door frames included



CITADELLE (C)  
SATIN CHROME  
SINGLE CYLINDER



### AVAILABLE FUNCTIONS

- 51 Single cylinder with thumb-turn ➔

## SELECTION GUIDE

CITADELLE // STANDARD

<b>B1</b>	<b>1</b>	<b>51</b>	<b>C</b>	<b>-</b>	<b>15</b>	<b>KD</b>	<b>M</b>
SERIES	KEYWAY <sup>1</sup>	FUNCTION	TYPE	FINISH	KEYING <sup>2</sup>	LATCH <sup>3</sup>	

(1) **1:** WEISER **2:** SCHLAGE (2) **KD:** KEYED DIFFERENT (DEFAULT); **KA:** KEYED ALIKE  
 (3) **W:** 4-WAY; **M:** FIXED MORTISE; **MR:** FIXED MORTISE (RND CORNER)

STYLE	10B OIL RUB. BRONZE	11P ANTIQUÉ BRONZE	15 SATIN NICKEL	15A ANTIQUÉ NICKEL	19 MATTE BLACK	26 POLISHED CHROME	26D SATIN CHROME	3 POLISHED BRASS	32D SATIN S.STEEL	4 SATIN BRASS	5 ANTIQUÉ BRASS	53 ANT. / POL. BRASS	/CASE
<b>CITADELLE ROUND</b>		•	•		•			•	•		•	•	24

OTHER FINISHES AVAILABLE, MINIMUM ORDER QUANTITIES AND/OR ADDITIONAL DELIVERY TIMES MAY BE REQUIRED – PLEASE CONTACT

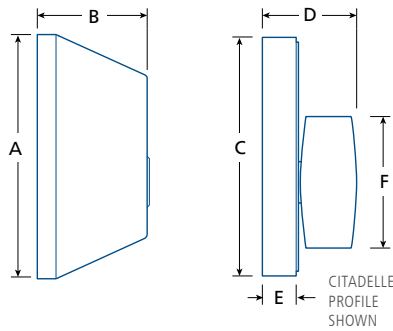

	A	B	C	D	E	F
<b>CITADELLE</b>						
<b>C</b>	∅ 2 <sup>9</sup> / <sub>16</sub> (65)	1 <sup>1</sup> / <sub>4</sub> (32)	∅ 2 <sup>1</sup> / <sub>2</sub> (63)	1 (25.5)	3 <sup>3</sup> / <sub>8</sub> (9.5)	1 <sup>13</sup> / <sub>32</sub> (36)

IN (MM)

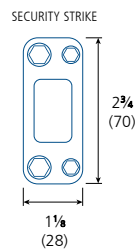
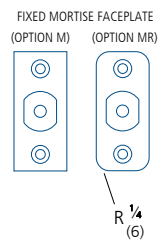
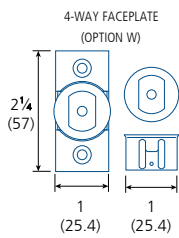

# POCKET DOOR

## RESIDENTIAL AUXILIARY LOCKS

### POCKET DOOR LOCK

2510, 2542



2510C15  
PASSAGE



2542C26D  
PRIVACY

- Fits doors 1 $\frac{3}{8}$ " (35 mm) thick
- Solid brass construction
- Handed, reversible
- Privacy model includes strike
- Mounting hardware included: wood screws

#### DIMENSIONS

2 $\frac{1}{4}$ " D x 3 $\frac{1}{4}$ " H x 1 $\frac{3}{8}$ " W (57 x 83 x 35 mm)

#### MODELS

2510: Passage  
2542: Privacy

2510	C15
MODEL	FINISH

C15	C15A	C19	C26	C26D	C3	C5
SATIN NICKEL	ANTIQUÉ NICKEL	MATTE BLACK	POLISHED CHROME	SATIN CHROME	POLISHED BRASS	ANTIQUÉ BRASS

OTHER FINISHES AVAILABLE—PLEASE CONTACT

### POCKET DOOR LOCK

2610, 2642



2610-11P  
PASSAGE



2642-26D  
PRIVACY



2610S-19  
PASSAGE



2642S-15  
PRIVACY

- Fits doors 1 $\frac{3}{8}$ –1 $\frac{3}{4}$ " (35–44.5 mm) thick with standard 160 or 161 door preparation
- Non-handed
- 2 $\frac{3}{8}$ " (60 mm) backset
- 2 $\frac{3}{4}$ " (70 mm) backset latch sold separately:  
#2610L234: Passage  
#2642L234: Privacy
- Spring-loaded pop-out edge pull
- Privacy model includes latch with integrated spring-loaded pop-out edge pull, dust box, and strike
- Mounting hardware included: wood screws

#### DIMENSIONS

Round rose:  $\varnothing$  2 $\frac{7}{16}$ " (62 mm)

Square rose (S):  $\varnothing$  2 $\frac{7}{16}$ " (62 mm)

Faceplate: 1 x 2 $\frac{1}{4}$ " (25.4 x 57 mm);  
 $\frac{1}{4}$ " (6.4 mm) radius corners\*

(\* ) Square corner faceplate available by special order.

#### MODELS

2610: Round, Passage

2642: Round, Privacy

2610S: Square, Passage

2642S: Square, Privacy

2642	-	26D
MODEL		FINISH

2610 / 2642

11P	15	15A	19	26	26D	3
ANTIQUÉ BRONZE	SATIN NICKEL	ANTIQUÉ NICKEL	MATTE BLACK	POLISHED CHROME	SATIN CHROME	POLISHED BRASS

OTHER FINISHES AVAILABLE—PLEASE CONTACT

2610S / 2642S

15	19	26D
SATIN NICKEL	MATTE BLACK	SATIN CHROME

OTHER FINISHES AVAILABLE—PLEASE CONTACT





- Certifications**
- Conforms to ANSI/BHMA A156.5, Grade 2
  - cULus listed, 2hr fire-rating
  - 3 Year limited mechanical warranty
  - 1 Year limited electronic warranty

**Door Thickness** • 1 $\frac{3}{8}$ –2" (35–51 mm)

**Handing** • Non handed

**Backset** • 2 $\frac{3}{8}$ –2 $\frac{3}{4}$ " (60–70 mm) adjustable

**Deadbolt** • Steel with hardened steel security pin  
• 1" (25.4 mm) throw

**Faceplate** • Mortise type, square corners  
• 1 x 2 $\frac{1}{4}$ " (25.4 x 57 mm)

**Strike** • Security strike (wood frame), square corners  
• 1 $\frac{1}{8}$  x 2 $\frac{3}{4}$ " (28.5 x 70 mm)

**Chassis** • Steel cylinder housing  
• Exposed mounting screws  
• Exterior rubber gasket

**Preparation** • Cross bore: 2 $\frac{1}{8}$ " or 1 $\frac{1}{2}$ " (54 or 38 mm)  
• Edge bore: 1" (25.4 mm)

**Cylinder** • Solid brass, 5-pin (drilled 6)  
• Schlage "C" keyway, 2 keys  
• Removable, rekeyable

*Other keyways and keying options available, including CX5 high security.*

**Interface** • Digital touch keypad  
• Blue LED back-light

**Electronic Features**

- 1 Programming code (8 digit)
- 25 User codes (4–8 digits)
- 4 Renewable single use codes
- Auto Lock with delay (99 sec. maximum)
- Vacation Mode (disables keypad)
- Optional random screen keypad activation code to prevent number probing
- Low battery power indicator

**Wireless Protocol**

- RFID - MIFARE™ 13.56 MHz (Classic 1K)
- 25 RFID token capacity
- 2 RFID cards included\*
- Two-factor authentication mode available (requires user code and RFID token)

*(\* Other single or dual frequency key fobs and bracelets available by special order.*

**Power** • DC 6V

*Four (4) AA 1.5V alkaline batteries NOT included*

**Operation Temperature** • -31° to 150.8°F (-35° to 66°C)  
*Temperature tolerance can vary due to weather conditions*

**Function** 51 Single cylinder, thumb-turn

**Finish** 15–Satin nickel, 19–Matte black

*Other finishes available by special order*

ASM	-	F400T	-	NR	-	2		51		KD		M	-	15
TYPE		SERIES		PROTOCOL		KEYWAY		FUNCTION		KEYING		LATCH		FINISH

## SELECTION GUIDE

SERIES	DESCRIPTION	FINISH <sup>1</sup>	/CASE
ASM-F400T-NR	RFID Electronic deadbolt with LED digital touch keypad. 	15, 19	6

(1) OTHER FINISHES AVAILABLE, MINIMUM ORDER QUANTITIES AND/OR ADDITIONAL DELIVERY TIMES MAY BE REQUIRED  
 KEYED FUNCTION; FULL KEYING SERVICES AVAILABLE

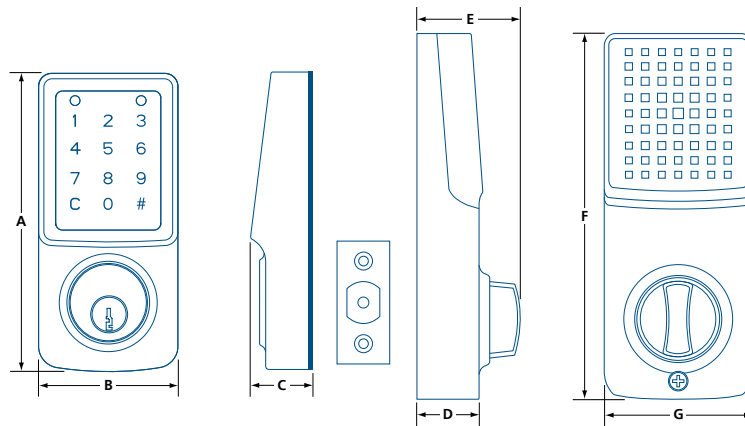

	A	B	C	D	E	F	G
F400T	5 <sup>7</sup> / <sub>16</sub> (138)	2 <sup>1</sup> / <sub>2</sub> (65)	1 <sup>1</sup> / <sub>8</sub> (29)	1 <sup>1</sup> / <sub>8</sub> (30)	2 (51.5)	6 <sup>13</sup> / <sub>16</sub> (173)	2 <sup>3</sup> / <sub>4</sub> (70)

IN (MM)

## PARTS & ACCESSORIES



**A-F400-PBC**  
Replacement battery cover for F400T.



**A-F4-PDW**  
11 in (28 cm) data wire.



**A-PDMF-BU**  
Single frequency RFID (13.56 MHz),  
Classic 1K key fob.



**A-F400-PIG**  
Optional rubber gasket for interior trim  
for F400T. *Not included.*





- Certifications**
- Conforms to ANSI/BHMA A156.2, Grade 2
  - 3 Year limited mechanical warranty
  - 1 Year limited electronic warranty
- Door Thickness**
- 1 3/8"–2" (35–51 mm)
- Handing**
- Non handed
- Backset**
- 2 3/8"–2 3/4" (60–70 mm) adjustable
- Spring Latch**
- Zinc alloy
  - 1/2" (12.7 mm) throw
- Faceplate**
- Mortise type, square corners
  - 1 x 2 1/4" (25.4 x 57 mm)
- Strike**
- T-Type, square corners
  - 1 1/8 x 2 3/4" (28.5 x 70 mm) wood frame
- Chassis**
- Zinc die-cast levers
  - Lever clutch release
  - Exposed mounting screws
  - Interior / exterior trim gaskets
- Preparation**
- Cross bore: 2 1/8" (54 mm)
  - Edge bore: 1" (25.4 mm)
- Cylinder**
- Solid brass, 5-pin
  - Schlage "C" keyway, 2 keys
  - Removable, rekeyable
- Other keyways and keying options available. May require special order.*
- Interface**
- Digital touch keypad
  - Blue LED back-light

- Electronic Features**
- 1 Programming code (8 digit)
  - 25 User codes (4–8 digits)
  - 4 Renewable single use codes
  - Auto Lock with delay (99 sec. maximum)
  - Vacation Mode (disables keypad)
  - Optional random screen keypad activation code to prevent number probing
  - Low battery power indicator
- Wireless Protocol**
- RFID - MIFARE™ 13.56 MHz (Classic 1K)
  - 25 RFID token capacity
  - 2 RFID cards included\*
  - Two-factor authentication mode available (requires user code and RFID token)
- (\* Other single or dual frequency key fobs and bracelets available by special order.)*
- Power**
- DC 6V
- Four (4) AA 1.5V alkaline batteries NOT included.*
- Operation Temperature**
- -31° to 150.8°F (-35° to 66°C)
- Temperature tolerance can vary due to weather conditions.*
- Function**
- 80 Storeroom
- Lever Style**
- JN–Juno (default), C–Curved return\*, H–Standard return\*
- (\* May require additional lead time.)*
- Finish**
- 15–Satin nickel, 19–Matte black
- Other finishes available by special order.*

ASM	-	F425T	-	NR	-	2		80		KD		M	-	JN	-	15
TYPE		SERIES		PROTOCOL		KEYWAY		FUNCTION		KEYING		LATCH		LEVER		FINISH

## SELECTION GUIDE

SERIES	DESCRIPTION	STYLE <sup>1</sup>	FINISH <sup>2</sup>	/ CASE
ASM-F425T-NR	RFID Electronic lever lockset with LED digital touch keypad. 	JN, C, H	15, 19	4

(1) OPTIONAL C, H STYLE LEVERS MAY REQUIRE ADDITIONAL LEAD TIME (2) OTHER FINISHES AVAILABLE, MINIMUM ORDER QUANTITIES AND/OR ADDITIONAL DELIVERY TIMES MAY BE REQUIRED.  
 KEYED FUNCTION; FULL KEYING SERVICES AVAILABLE.

### OPTIONAL LEVERS



(C) Curved return



(H) Standard return

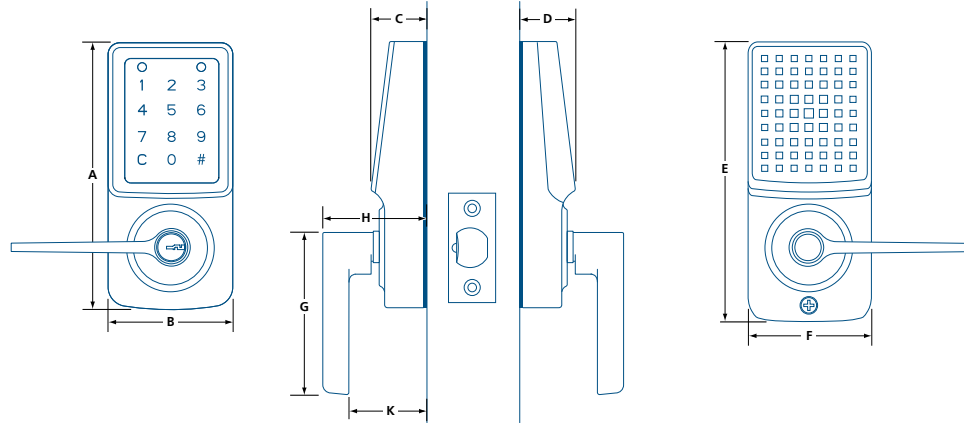

	A	B	C	D	E	F	G	H	K
<b>F425T JN (JUNO)</b>	6 <sup>1</sup> / <sub>8</sub> (155)	3 (76)	1 <sup>11</sup> / <sub>32</sub> (34)	1 <sup>1</sup> / <sub>4</sub> (32)	6 <sup>1</sup> / <sub>8</sub> (155)	2 <sup>29</sup> / <sub>32</sub> (74)	4 <sup>25</sup> / <sub>32</sub> (121.2)	2 <sup>27</sup> / <sub>32</sub> (72.5)	2 (50.8)

IN (MM)

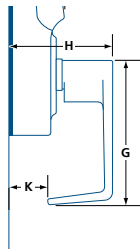
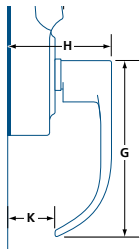

	G	H	K
<b>F425T C</b>	4 <sup>11</sup> / <sub>16</sub> (118.9)	2 <sup>27</sup> / <sub>32</sub> (72.5)	1 <sup>3</sup> / <sub>32</sub> (27.7)
<b>F425T H</b>	4 <sup>3</sup> / <sub>16</sub> (106.2)	2 <sup>27</sup> / <sub>32</sub> (72.5)	1 (25.6)

IN (MM)

## PARTS & ACCESSORIES



**A-F425-PBC**  
Replacement battery cover for F425T.



**A-F425-PST**  
Replacement screen trim for F425T.



**A-PDMF-BU**  
Single frequency RFID (13.56MHz),  
Classic 1K key fob.





- Certifications**
  - Conforms to ANSI/BHMA A156.5, Grade 2
  - cULus listed, 20min fire-rating
  - UL 1043, Safety for Burglary-Resistant Electric Locking Mechanisms
  - 3 Year limited mechanical warranty
  - 1 Year limited electronic warranty
- Door Thickness**
  - 1<sup>3</sup>/<sub>8</sub>–2" (35–51 mm)
- Handing**
  - Non handed
- Backset**
  - 2<sup>3</sup>/<sub>8</sub>–2<sup>3</sup>/<sub>4</sub>" (60–70 mm) adjustable
- Deadbolt**
  - Steel with hardened steel security pin
  - 1" (25.4 mm) throw
- Faceplate**
  - Mortise type, square corners
  - 1 x 2<sup>1</sup>/<sub>4</sub>" (25.4 x 57 mm)
- Strike**
  - Security strike (wood frame), square corners
  - 1<sup>1</sup>/<sub>8</sub> x 2<sup>3</sup>/<sub>4</sub>" (28.5 x 70 mm)
- Chassis**
  - Steel cylinder housing
  - Exposed mounting screws
  - Integrated all-weather seal
- Preparation**
  - Cross bore: 2<sup>1</sup>/<sub>8</sub>" or 1<sup>1</sup>/<sub>2</sub>" (54 or 38 mm)
  - Edge bore: 1" (25.4 mm)
- Cylinder**
  - Solid brass, 5-pin (drilled 6)
  - Schlage "C" keyway, 2 keys
  - Removable, rekeyable

*Other keyways and keying options available, including CX5 high security.*

- Interface**
  - Digital touch keypad
  - White LED back-light
- Electronic Features**
  - iKey Connect mobile app control (iOS / Android)
  - 200 User credentials per lock
  - PIN codes can be single use, scheduled, or permanent
  - Optional keyless entry (geofencing)
  - Optional auto-lock with delay (900 sec. max.)
  - Optional random keypad activation code to prevent number probing
  - Vacation mode (disables keypad)
  - Audit trail (accessible via app)
  - Low battery power indicator (in-app / on-device)
  - Multi-lock management\*

*(\*) Local touring, lock-to-phone management, see instructions for details.*

- Protocol**
  - BLE Pairing (128-bit encryption)
- Operation**
  - -31° to 150.8°F (-35° to 66°C)
- Temperature**
  - *Temperature tolerance can vary due to weather.*
- Power**
  - DC 6V
  - *Four (4) AA 1.5V alkaline batteries NOT included*
- Function**
  - 51 Single cylinder, thumb-turn
- Finish**
  - 15–Satin nickel, 19–Matte black
  - *Other finishes available by special order*

AMM	-	F500T	-	NB	-	2		51		KD		M	-	15
TYPE		SERIES		PROTOCOL		KEYWAY		FUNCTION		KEYING		LATCH		FINISH



## SELECTION GUIDE

SERIES	DESCRIPTION	FINISH <sup>1</sup>	/CASE
<b>AMM-F500T-NB</b>	Smart BLE Electronic deadbolt with LED digital touch keypad. 	15, 19	6

(1) OTHER FINISHES AVAILABLE, MINIMUM ORDER QUANTITIES AND/OR ADDITIONAL DELIVERY TIMES MAY BE REQUIRED  
 KEYED FUNCTION; FULL KEYING SERVICES AVAILABLE

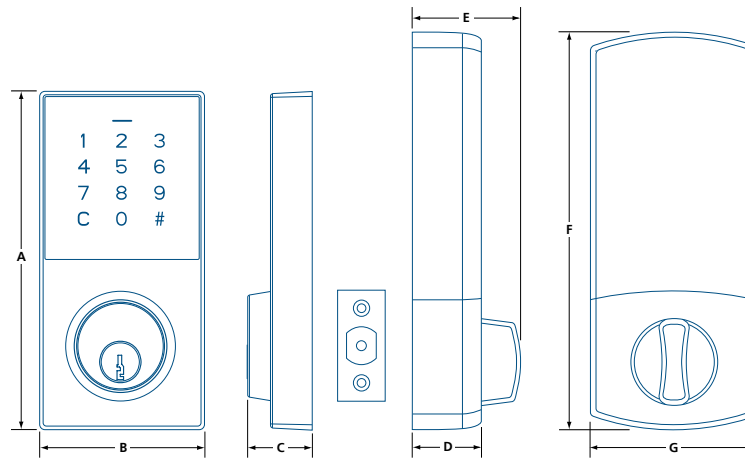

	A	B	C	D	E	F	G
<b>F500T</b>	5 <sup>3</sup> / <sub>8</sub> (136)	2 <sup>5</sup> / <sub>8</sub> (66)	1 (26)	1 <sup>1</sup> / <sub>8</sub> (28)	1 <sup>3</sup> / <sub>4</sub> (44)	6 <sup>5</sup> / <sub>16</sub> (160)	2 <sup>5</sup> / <sub>8</sub> (67)

IN (MM)

## PARTS & ACCESSORIES



**A-F4-PDW**  
 11 in (28 cm) data wire.



# ER SERIES

## ELECTRONIC DEADBOLT



1  
YEAR



REMOTE CONTROL  
INCLUDED

- Certifications** • 1 Year limited warranty
- Door Thickness** • 1 $\frac{3}{8}$ –2" (35–51 mm)
- Handing** • Non handed
- Backset** • 2 $\frac{3}{8}$ –2 $\frac{3}{4}$ " (60–70 mm), adjustable
- Deadbolt** • Steel bolt with hardened steel security pin  
• 1" (25.4 mm) throw
- Faceplate** • Mortise type, square corner  
• 1 $\frac{1}{8}$ x2 $\frac{1}{4}$ " (29x57 mm)
- Strike** • 1 $\frac{1}{8}$ x2 $\frac{3}{4}$ " (29x70 mm) wood frame
- Preparation** • Cross bore: 2 $\frac{1}{8}$ " (54 mm)  
• Edge bore: 1" (25.4 mm)  
*See installation instructions for details*
- Cylinder** • 5-pin, removable cylinder  
• Weiser keyway, 2 keys  
*Other keyways and keying options available*

- Electronic Features** • Battery powered\*, low battery indicator  
• LED illuminated keyboard  
• Fully programmable from keyboard, no computer required  
• For up to 6 users (4 to 10 digit code)  
• Settings saved in memory  
• Visual and audio confirmation and notifications  
• Remote control (98 ft/30 m range) included  
• Auto-locking function available  
*(\*) Four (4) AA batteries not included*

- Operating Temperature** • -4° to 185°F (-20° to 85°C)  
• 30 to 90% humidity  
*Rubber gaskets prevent water penetration*

- Functions** 51 Single cylinder, thumbturn

- Styles** ER–Traditional body, SER–Contemporary body

- Finish** 11P–Antique bronze, 15–Satin nickel,  
15A–Antique nickel, 19–Matte black,  
26D–Satin chrome, V3–Polished brass (lifetime)  
*Other finishes available by special order*

201	51	SER	26D	KD	U
SERIES	FUNCTION	STYLE	FINISH	KEYING	LATCH <sup>1</sup>

(1) U–UNIVERSAL LATCH, CONVERTS TO DRIVE-IN

## SELECTION GUIDE

MODEL	DESCRIPTION	FINISH
201 51 ER	Electronic deadbolt with LED keypad & remote, traditional style. ➤	11P, 15, 15A, 19, 26D, V3
201 51 SER	Electronic deadbolt with LED keypad & remote, contemporary style. ➤	15, 15A, 19, 26D

OTHER FINISHES AVAILABLE, MINIMUM ORDER QUANTITIES AND/OR ADDITIONAL DELIVERY TIMES MAY BE REQUIRED  
 ➤ KEYED FUNCTION; FULL KEYING SERVICES AVAILABLE

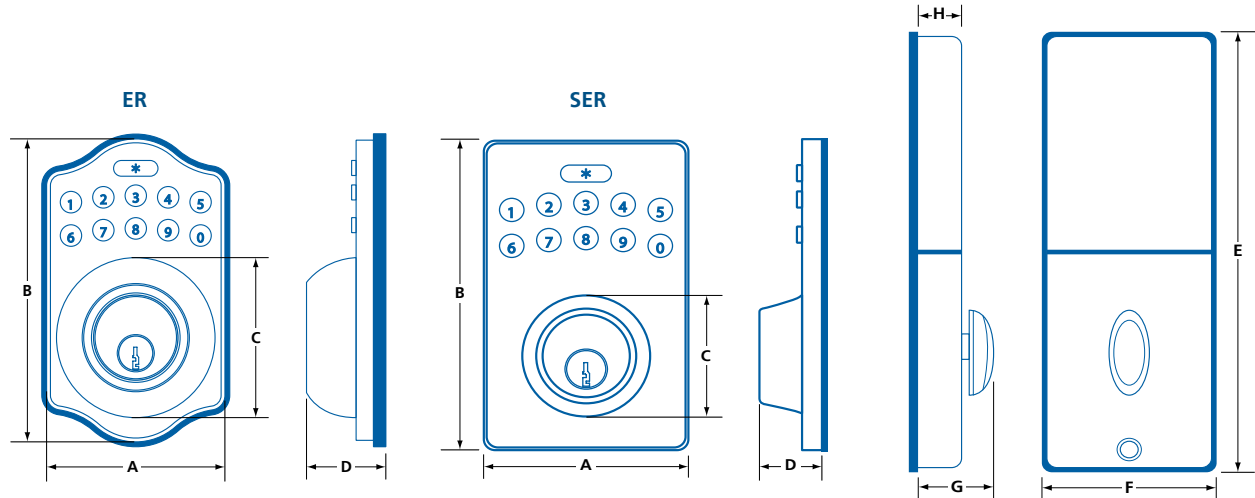

	A	B	C	D	E	F	G	H
ER	27/8 (73)	47/8 (124)	29/16 (65)	13/8 (35)	7 1/4 (184)	2 11/16 (68)	1 3/4 (44)	1 1/16 (27)
SER	3 (76)	49/16 (116)	1 15/16 (49)	1 1/8 (29)	7 1/4 (184)	2 11/16 (68)	1 3/4 (44)	1 1/16 (27)

IN (MM)

## PARTS & ACCESSORIES



### 200ERC

Additional remote control with override key.  
 Battery included.



- Reliable, quality, and convenient modern electronic entry handleset for residential homes
- Includes F500 smart electronic deadbolt, classic interior lever and exterior handle
- Control and configure your lock using the intuitive iKey mobile application. Grant access to family, guests or service providers with a simple tap on your device. Available for both iOS and Android smartphones.



- Deadbolt conforms to ANSH/BHMA Grade 2
- UL 1034, Safety for Burglary-Resistant Electric Locking Mechanisms
- 3-year limited mechanical warranty
- 1-year limited finish warranty
- 1-year limited electronic warranty
- Non-handed, zinc die-cast exterior trim
- For doors 1¾–2¼" (44.5–57 mm) thick
- Fits standard 2½" (54 mm) door preparation with 1" (25.4 mm) edge bore
- Steel tubular spring latch with adjustable 2¾–2¾" (60–70 mm) backset.
- Steel 1" (25.4 mm) deadbolt latch with hardened steel security pin and adjustable 2¾–2¾" (60–70 mm) backset
- Mortised faceplate with square corners, convertible to drive-in
- Integrated all-weather seal for outdoor use
- Deadbolt operated by touchscreen or key
- 5-pin brass cylinder in steel housing with 2 keys
- Full-lip strike and 2-piece deadbolt strike and dustbox included
- Handle with adjustable mounting post
- Requires 4 AA batteries (not included)

### ELECTRONIC FEATURES

- Digital touchscreen, blue LED backlight
- 200 User credentials per lock
- PIN Codes can be single use, scheduled, or permanent
- Optional keyless entry (geofencing)
- Optional auto-lock with delay (900 sec. max.)
- Optional random keypad activation code to prevent number probing
- Vacation mode (disables keypad)
- Audit trail (accessible via app)
- Low battery power indicator (in-app / on-device)
- Multi-lock management\* – manage multiple F500 locks with one app

(\* Local touring, lock-to-phone management, see instructions for details.



SATIN NICKEL



SELECTION GUIDE

F500T	-	NB	-	LAS	-	1	51	KD	M	-	15	
SERIES	PROTOCOL	STYLE <sup>1</sup>	KEYWAY <sup>2</sup>	FUNCTION	KEYING	LATCH	FINISH					

(1) LAS: LEVER WITH ROUND ROSE (2) 1: SCHLAGE; 2: WEISER

	10B OIL RUB. BRONZE	11P ANTIQU BRONZE	15 SATIN NICKEL	15A ANTIQU NICKEL	19 MATTE BLACK	26 POLISH CHROME	26D SATIN CHROME	3 POLISH BRASS	32D SATIN S.STEEL	4 SATIN BRASS	C5 ANTIQU BRASS	V3* POLISH BRASS	/CASE
<b>T500 COMBO</b>	LAS		●		●								6

OTHER FINISHES AVAILABLE, MINIMUM ORDER QUANTITIES AND/OR ADDITIONAL DELIVERY TIMES MAY BE REQUIRED – PLEASE CONTACT (\*) LIFETIME FINISH WARRANTY

DIMENSIONS

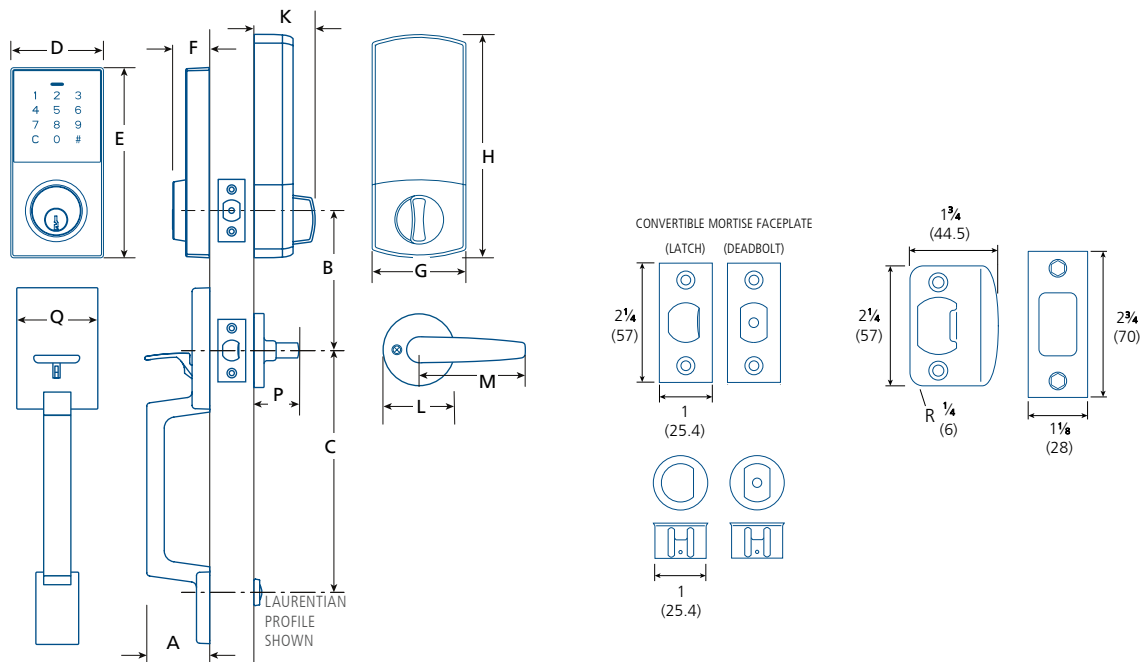

	A	B <sup>1</sup>	C	D	E	F	G	H	K	L	M	P	Q
<b>T500 COMBO</b>	2¼	5	87/16 (214)	2¾	5½	1	2⅝	6⅝	1¾	2⅞	3½	2	2¾
<b>LAS</b>	(54)	(127)	8⅝ (219) <sup>2</sup> 8¾ (228)	(60)	(139)	(26)	(67)	(160)	(44)	(65)	(88.9)	(50.8)	(62)

IN (MM) (1) RECOMMENDED DISTANCE (2) DEFAULT MOUNTING DISTANCE



- Reliable and convenient modern electronic entry handleset for residential single family homes
- Concealed mounting screws
- Includes T300 electronic deadbolt, Linea interior lever and Delta exterior handle
- Interior lever can be swapped with any other Tecnica Design lever<sup>1</sup>
- Available with round or square interior trim

(1) Availability may vary, please contact your local Dorex representative.

- 3-year limited mechanical warranty
- 5-year limited finish warranty
- 1-year limited electronic warranty
- Non-handed, zinc die-cast exterior trim
- For doors 1¾–2¼" (44.5–57 mm) thick
- Fits standard 2½" (54 mm) door preparation with 1" (25.4 mm) edge bore
- Steel tubular spring latch with adjustable 2¾–2¾" (60–70 mm) backset.
- Steel 1" (25.4 mm) deadbolt latch with hardened steel security pin and adjustable 2¾–2¾" (60–70 mm) backset
- Mortised faceplate with square corners, convertible to drive-in
- Galvanized steel interior mechanism
- Temperature: -20° to 60°C (-4° to 140°F)
- Weiser 5-pin brass cylinder in steel housing with 2 keys
- Full-lip strike and deadbolt security strike for wood door frames included

### ELECTRONIC FEATURES

- Deadbolt operated by touchscreen keypad or key
- Can handle up to 70 user codes, and 5 renewable single-use codes
- Proximity sensor lights keypad when approached
- Anti-fingerprint surface prevents code guessing
- Touchscreen keypad stays lit for 30 seconds after activity
- Automatic locking for peace of mind
- Vacation mode deactivates the keypad while away
- Low battery indicator (audible and visible)
- Requires four (4) 1.5v AA batteries (not included)



SATIN NICKEL

LT

ROUND TRIM AVAILABLE

SELECTION GUIDE

T300T	-	N	-	DT	LTS	-	1	51	KD	M	-	15
SERIES	PROTOCOL	STYLE	TRIM <sup>1</sup>	KEYWAY	FUNCTION	KEYING	LATCH	FINISH				

(1) LTS: LINEA SQUARE LT: LINEA ROUND

	10B	11P	15	15A	19	26	26D	3	32D	4	C5	V3*	/CASE
	OIL RUB. BRONZE	ANTIQU BRONZE	SATIN NICKEL	ANTIQU NICKEL	MATTE BLACK	POLISHED CHROME	SATIN CHROME	POLISHED BRASS	SATIN S.STEEL	SATIN BRASS	ANTIQU BRASS	POLISHED BRASS	
<b>T300 COMBO</b>	DT		•		•								6

OTHER FINISHES AVAILABLE, MINIMUM ORDER QUANTITIES AND/OR ADDITIONAL DELIVERY TIMES MAY BE REQUIRED – PLEASE CONTACT (\*) LIFETIME FINISH WARRANTY

DIMENSIONS

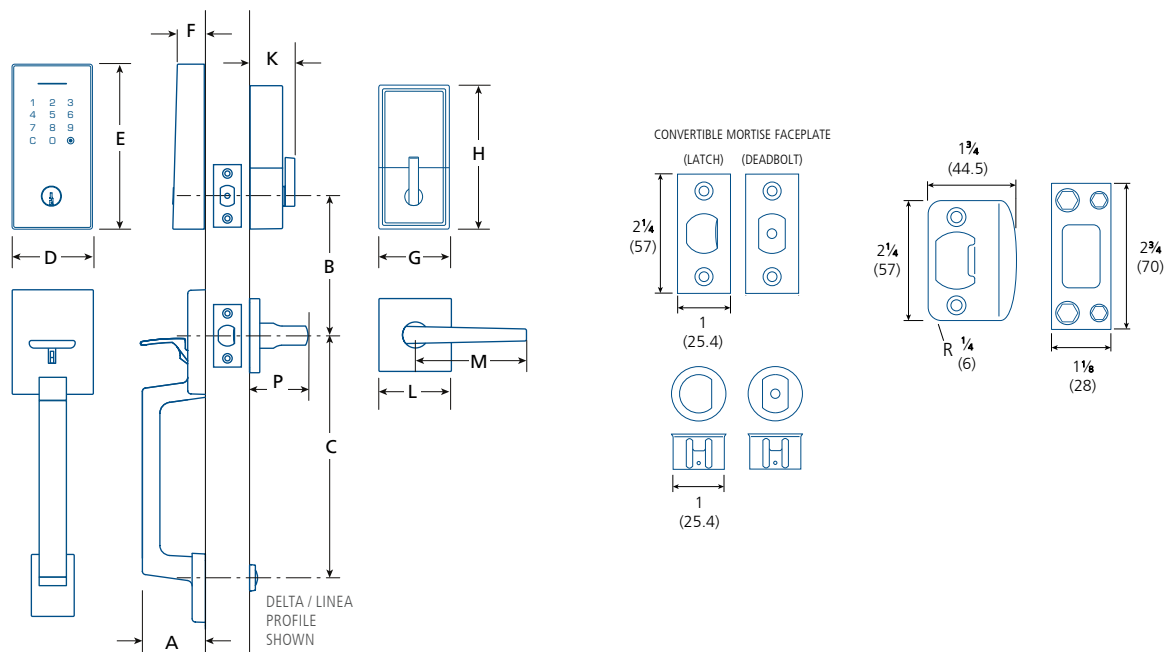

	A	B	C	D	E	F	G	H	K	L	M	P
<b>T300 COMBO</b>	2 1/8	5 <sup>1</sup>	8 13/32	2 5/8	5 3/4	1	2 11/16	5 3/16	1 1/2	2 9/16	4	2 3/8
DT LTS	(54)	(127)	(214)	(66)	(146)	(25.4)	(68)	(132)	(38)	(64.5)	(102)	(60)

IN (MM) (1) RECOMMENDED DISTANCE



# DDL 1150 SERIES

DIGITAL LOCKSET



- Certifications** • 1 Year limited warranty
- Door Thickness** • 1 $\frac{3}{8}$ "–2" (35–51 mm)
- Handing** • Handed
- Backset** • 2 $\frac{3}{4}$ " (70 mm)  
• 2 $\frac{3}{8}$ " (60 mm) – available
- Latch** • Stainless steel deadlatch  
•  $\frac{1}{2}$ " (12.7 mm) throw
- Faceplate** • Mortise type, square corners  
• 1 $\frac{1}{8}$ "x2 $\frac{1}{4}$ " (29x57 mm)
- Strike** • 1 $\frac{1}{8}$ "x2 $\frac{3}{4}$ " (29x70 mm)  
• Plastic dust-box
- Chassis** • Zinc alloy case with rubber seal  
• Stainless steel mechanical push buttons  
• Exposed mounting screws

- Preparation** • Cross bore: 2 $\frac{1}{8}$ " (54 mm)  
• Edge bore: 1" (25.4 mm)
- Cylinder** —
- Function** Exterior lever always locked unless unlocked by entering correct combination or by inside lever.
- Lever Style** Lever with curved return
- Finish** SC–Satin chrome  
*Other finishes available by special order*
- Notes** • Recommended for indoor use only  
• Completely mechanical, no batteries required  
• Easy combination changes

1150	SC	–	LH
SERIES	FINISH		HAND <sup>1</sup>

(1) LH– LEFT HAND; RH– RIGHT HAND

## DIMENSIONS

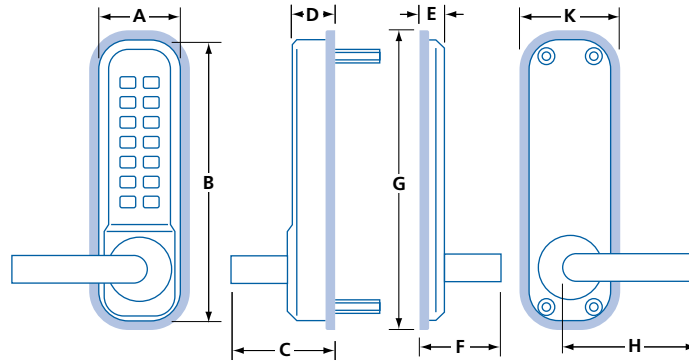

	A	B	C	D	E	F	G	H	K
<b>1150</b>	2 $\frac{1}{8}$ (54)	7 $\frac{9}{16}$ (185)	2 $\frac{1}{2}$ (64)	1 $\frac{5}{16}$ (33)	1 $\frac{3}{16}$ (20)	2 $\frac{1}{4}$ (57)	7 $\frac{1}{2}$ (190)	4 $\frac{5}{16}$ (110)	2 $\frac{7}{16}$ (62)

IN (MM)

## PARTS & ACCESSORIES



### DLSC238

Deadlatch bolt, 2 $\frac{3}{8}$ " (60mm) backset,  
1 $\frac{1}{8}$  x 2 $\frac{1}{4}$ " (29x57 mm) faceplate

### DLSC234

Deadlatch bolt, 2 $\frac{3}{4}$ " (70mm) backset,  
1 $\frac{1}{8}$  x 2 $\frac{1}{4}$ " (29x57 mm) faceplate



# DDL 2200 SERIES

## DIGITAL LOCKSET



- Certifications** • 1 Year limited warranty
- Door Thickness** •  $1\frac{3}{8}$ "–2" (35–51 mm)  
•  $2\frac{1}{4}$ " (57 mm) – available
- Handing** • Non handed
- Backset** •  $2\frac{3}{4}$ " (70 mm)  
•  $2\frac{3}{8}$ " (60 mm) – available  
• 2200 :  $1\frac{1}{8}$ " (28 mm)
- Latch** • 2200: deadbolt;  $\frac{7}{8}$ " (22 mm) throw  
• 2212: deadbolt with security pin;  
1" (25.4 mm) throw  
• 2230: security deadlatch;  
 $\frac{1}{2}$ " (12.7 mm) throw
- Faceplate** • Mortise type, square corners  
•  $1\frac{1}{8}$ x $2\frac{1}{4}$ " (29x57 mm)  
• 2200: None, not applicable
- Strike** • T-Type;  $1\frac{1}{8}$ x $2\frac{3}{4}$ " (29x70 mm)  
• Plastic dust-box  
• 2200: includes surface strike
- Chassis** • Zinc alloy case with rubber seal  
• Stainless steel mechanical push buttons  
• Exposed mounting screws

- Preparation** • Special, see installation instructions for details  
• Trim plate for installation on doors with  
 $2\frac{1}{8}$ " (54 mm) preparation – available  
• 2200: surface mounted, fits any flat surface  
door and frame

**Cylinder** —

- Function** Exterior knob always locked unless unlocked  
by entering correct combination, or by turning  
inside thumb-turn.

**Knob Style** Flat knob with ridges

*Large diameter knob available – see parts & accessories*

**Finish** AB–Antique bronze, PB–Polished brass,  
SC–Satin chrome, SN–Satin nickel

*Other finishes available by special order*

- Notes** • Recommended for indoor use only  
• Completely mechanical, no batteries required  
• Easy combination changes

2230	SC
MODEL	FINISH

## SELECTION GUIDE

MODEL	DESCRIPTION	FINISH
2200	Combination deadbolt lock, surface mounted, 1½" (28mm) backset	SC
2212	Combination deadbolt lock, 2¾" (70mm) backset	AB, PB, SC
2230	Combination deadlatch lock, 2¾" (70mm) backset	SC, SN

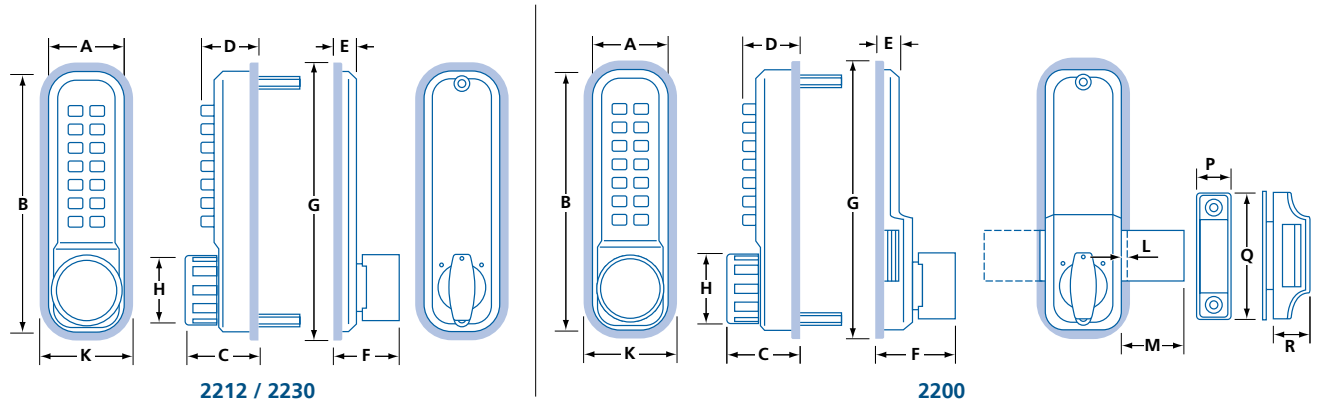

	A	B	C	D	E	F	G	H	K	L	M	P	Q	R
<b>2200</b>										1/16 (2)	7/8 (22)	25/32 (20)	23/4 (70)	7/8 (22)
<b>2212</b>	1 5/8 (41)	5 9/16 (143)	1 9/16 (40)	1 3/16 (30)	1 5/32 (12)	1 5/8 (42)	6 (152)	1 7/16 (36)	2 (51)	—	—	—	—	—
<b>2230</b>										—	—	—	—	—

IN (MM)

## PARTS & ACCESSORIES



**DLSC238**  
Deadlatch bolt, 2¾" (60mm) backset,  
1½x2¼" (29x57mm) faceplate



**DLSC234**  
Deadlatch bolt, 2¾" (70mm) backset,  
1½x2¼" (29x57mm) faceplate



**DBS238**  
Deadbolt, 2¾" (60mm) backset,  
1½x2¼" (29x57mm) faceplate

**DBS234**  
Deadbolt, 2¾" (70mm) backset,  
1½x2¼" (29x57mm) faceplate

**DETTP**  
Metal 2½x6½" (64x165mm) retro-fit trim  
plate for pre-drilled 2½" (54mm) doors.

**DETPR**  
Rubber 2½x6½" (64x165mm) retro-fit trim  
gasket for pre-drilled 2½" (54mm) doors.



**KNOB**  
Easy-grip knob, 1¾" (44mm) diameter.  
» Antique brass (KNOBAB)  
» Polished brass (KNOBBP)



**RP2200**  
2¼" (57mm) door kit for DDL 2200.

**RP2210**  
2¼" (57mm) door kit for DDL 2212,2230.



# PF SERIES

## GLASS DOOR LOCKS

1  
YEAR



PF210  
PASSAGE



SILENT LATCH



PF251  
ENTRY (KIK CYLINDER)



PF251P  
PROFILE CYLINDER

**Warranty** • 1 Year limited warranty

**Panel Thickness** • For tempered glass panels  
•  $\frac{5}{16}$ – $\frac{1}{2}$ " (8–12.7 mm) thick  
•  $\frac{19}{32}$ " (15 mm) extension kit (#PF2-EXT)

**Handing** • Handed, field reversible\*

(\* *Handing conversion is possible only from LH to RH or LHR to RHR (and vice versa). See handing guide.*)

**Spring Latch** • Stainless steel,  $\frac{1}{2}$ " (12.7 mm) throw  
• Derlin stripe for silent/smooth operation

**Strike** • ASA strike – available  
• Metal frame strike – available  
• Glass panel strike – available

*Strikes not included, sold separately. See Parts & Accessories*

**Trim** • High strength zinc-alloy body  
• Stainless steel covers

*Levers not included, sold separately. See Parts & Accessories*

**Chassis** • Concealed mounting  
• Shims and gaskets included

**Preparation** • Glass cut-out required. See installation instructions for details

**Cylinder** • 5-pin cylinder  
• Schlage "C" keyway, 2 keys  
• Removable  
• Profile cylinders sold separately  
*Keying services available.*

**Functions** 200 Glass panel strike  
210 Passage  
251 Entry  
251P Entry, profile cylinder (less core)

**Levers** • Wide variety of lever styles  
• Sold separately – see Parts & Accessories

**Finish** 630–Satin stainless steel  
19–Matte black\*

(\* *Special order. Other finishes also available by special order*)

PF	251	LH	–	630
SERIES	FUNCTION <sup>1</sup>	HAND		FINISH

(1) SEE SELECTION CHART FOR DETAILS

(2) LH: LEFT RH: RIGHT LHR: LEFT, REVERSED RHR: RIGHT, REVERSED

## SELECTION GUIDE

SERIES	FUNCTION / DESCRIPTION	FINISH <sup>1</sup>	/ CASE
PF	210 Passage	630, 19*	20
PF	251 Entry, cylinder included ➔	630, 19*	20
PF	251P Entry, profile cylinder (less core)	630, 19*	20
PF	200 Strike for glass side panel	630, 19*	**

(1) OTHER FINISHES AVAILABLE, MINIMUM ORDER QUANTITIES AND/OR ADDITIONAL DELIVERY TIMES MAY BE REQUIRED. (\*) SPECIAL ORDER, MAY REQUIRE ADDITIONAL DELIVERY TIME  
 (\*\*) CONTACT LOCAL REPRESENTATIVE FOR DETAILS. ➔ KEYED FUNCTION; FULL KEYING SERVICES AVAILABLE.

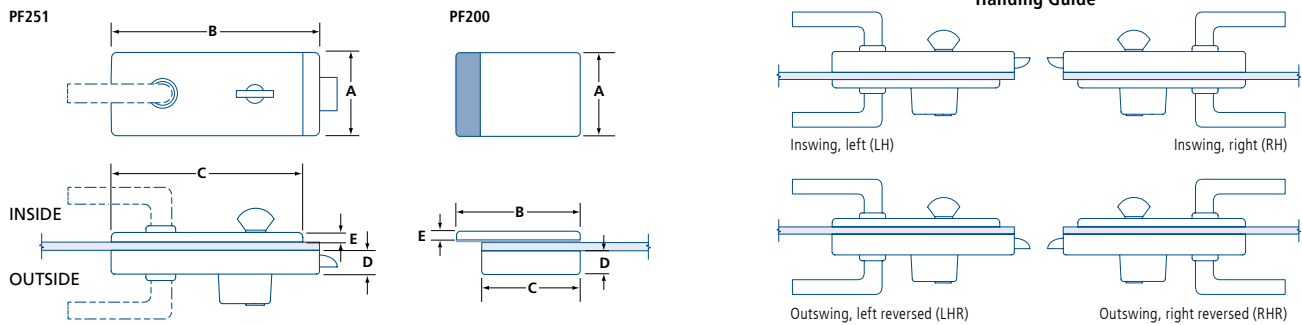

	A	B	C	D	E
<b>PF210</b>	2 <sup>5</sup> / <sub>8</sub>	6 <sup>1</sup> / <sub>2</sub>	5 <sup>7</sup> / <sub>8</sub>	7 <sup>7</sup> / <sub>8</sub>	5 <sup>5</sup> / <sub>16</sub>
<b>PF251</b>	(67)	(165)	(150)	(22)	(8)
<b>PF200</b>	2 <sup>5</sup> / <sub>8</sub>	3	2 <sup>3</sup> / <sub>8</sub>	7 <sup>7</sup> / <sub>8</sub>	5 <sup>5</sup> / <sub>16</sub>
	(67)	(76)	(60)	(22)	(8)

IN (MM)

## PARTS & ACCESSORIES



**PFL001-32D**  
Straight lever style (sold in pairs).



**PFL018-32D**  
Curved lever style (sold in pairs).



**CBPT1530-SCKD-15**  
Schlage "C" keyway profile cylinder with thumb-turn. Not rekeyable. For LH/RH PF251P locks.



**CBPT3131-SCKD-15**  
Schlage "C" keyway profile cylinder with thumb-turn. Not rekeyable. For LHR/RHR PF251P lock.



**9203**  
Viro profile cylinder, double cylinder brass plated. Required for master key systems with PF251P. Rekeyable.



**LS01**  
For metal door frames 1<sup>3</sup>/<sub>4</sub>" to 2" (44.5 mm to 50 mm) thick. Includes dust-box, mounting plate and machine screws.



**ASAC15**  
ASA strike for 1<sup>3</sup>/<sub>4</sub>" to 2" (44.5 mm to 50 mm) door frame. 1<sup>1</sup>/<sub>4</sub>x4<sup>7</sup>/<sub>8</sub>" (32x124 mm)



**PF200**  
Patch fitting lock strike for glass side panel up to 1<sup>9</sup>/<sub>32</sub>" (15 mm) thick.



**PF2-EXT**  
Extension kit for panel thicknesses up to 1<sup>9</sup>/<sub>32</sub>" (15 mm). For PF210 or PF251.



# PF SERIES

## GLASS DOOR FLOOR DEADBOLTS

1  
YEAR



**PF181**  
FLOOR DEADBOLT



**PF180**  
FLOOR DEADBOLT

**Warranty** • 1 Year limited warranty

**Panel Thickness** • For tempered glass panels  
5/16–1/2" (8–12.7 mm) thick

**Handing** • Non-handed

**Deadbolt** • Solid zinc-alloy floor bolt  
• 1 1/16" (17.5 mm) throw  
• PF180: round bolt, 3/32" (2.4 mm) thick  
• PF181: flat bolt, 3/32" (2.4 mm) thick

**Strike** • Steel floor strike  
• Dust-proof floor strike – available\*

(\* ) For PF180 only. See Parts & Accessories

**Trim** • High strength zinc-alloy body  
• Stainless steel covers

**Chassis** • Concealed mounting  
• Shims and gaskets included

**Preparation** • Glass cut-out required. See installation instructions for details

**Cylinder** • PF180: 4-pin profile double cylinder  
• PF181: 5-pin profile double cylinder  
• Yale keyway, 3 keys

*Other keyways and keying options available.*



**Finish** 630–Satin stainless steel  
19–Matte black\*

(\* ) Special order. Other finishes also available by special order

PF	180	–	630
SERIES	FUNCTION <sup>1</sup>		FINISH

(1) SEE SELECTION CHART FOR DETAILS

## SELECTION GUIDE

SERIES	FUNCTION / DESCRIPTION	FINISH <sup>1</sup>	/ CASE
PF 181	Flat floor bolt, 5-pin profile double cylinder 	630, 19*	**
PF 180	Round floor bolt, 4-pin profile double cylinder 	630, 19*	**

(1) OTHER FINISHES AVAILABLE, MINIMUM ORDER QUANTITIES AND/OR ADDITIONAL DELIVERY TIMES MAY BE REQUIRED. (\*) SPECIAL ORDER, MAY REQUIRE ADDITIONAL DELIVERY TIME  
 (\*\*) CONTACT LOCAL REPRESENTATIVE FOR DETAILS.  KEYED FUNCTION; FULL KEYING SERVICES AVAILABLE.

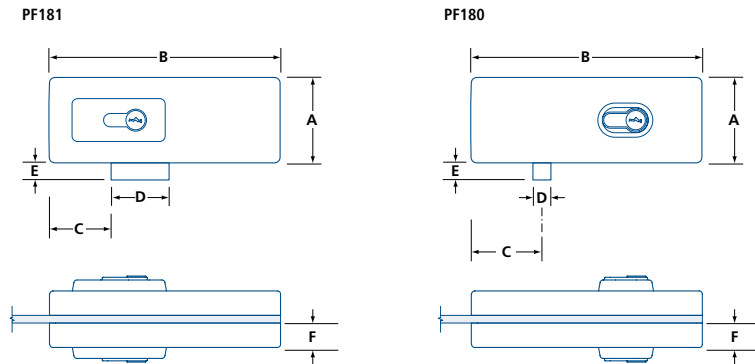

	A	B	C	D	E	F
PF181	2 (51)	6 <sup>7</sup> / <sub>16</sub> (163.3)	2 <sup>1</sup> / <sub>8</sub> (54)	1 <sup>7</sup> / <sub>16</sub> (36)	1 <sup>1</sup> / <sub>16</sub> (17.5)	3 <sup>3</sup> / <sub>8</sub> (9)
PF180	2 (51)	6 <sup>7</sup> / <sub>16</sub> (163.3)	3 <sup>15</sup> / <sub>32</sub> (87.7)	9 <sup>9</sup> / <sub>16</sub> (14.6)	1 <sup>1</sup> / <sub>16</sub> (17.5)	5 <sup>5</sup> / <sub>16</sub> (8)

IN (MM)

## PARTS & ACCESSORIES



**CBPT3131-SCKD-15**  
 Schlage "C" keyway profile cylinder with thumb-turn for PF181 locks.



**9203**  
 Viro profile cylinder, brass plated. Required for master key systems with PF181.



**T840**  
 Aluminum dust-proof strike with spring loaded plunger; 3/4" (19 mm) engagement depth. Can be used with PF180. See page 06.305.



**DSP / DSPL**  
 Adjustable stainless steel dust-proof strike with spring loaded plunger; 3/4" (19 mm) engagement depth. Available with locking (DSPL) and non-locking plunger (DSP). Can be used with PF180. See page 06.305.

