

INSTRUCTIONS FOR INSTALLATION OF ONE SIDED DEADLOCK WITH 1" (25.4mm) DEADBOLT FOR 2-1/8" (54mm) DOOR HOLE

FOR USE ON DOOR THICK
1-3/8" TO 1-3/4" (35mm~45mm)

TOOLS REQUIRED FOR REMODELING OR NEW CONSTRUCTION

1 phillips head screwdriver 1 2-1/8" (54mm) hole saw
1 1" (25.4mm) drill bit 1 chisel

1. MARK DOOR

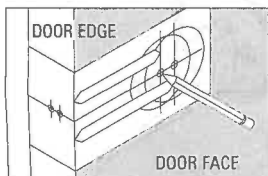

Start approximately 36" (914mm) from floor.
Fold and apply template on door edge and mark center of 2-1/8" (54mm) hole on door face.

NOTE : Backset 2-3/8" (60mm) or 2-3/4" (70mm), On door face must match backset of your lock.

2. DRILL HOLES

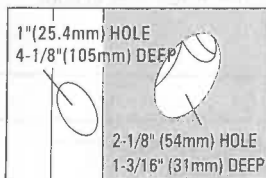

Drill 1" (25.4mm) hole 4-1/8" (105mm) deep in center of door edge whatever 2-3/8" or 2-3/4" (60mm or 70mm) backset.

Drill from room side or inside of door 2-1/8" (54mm) hole 1-3/16" (31mm) deep on door face.

NOTE : Do not drill more than 1-3/16" (31mm) deep.
make sure not to break through to opposite side of door.
Drill just pass 1" (25.4mm) hole for deadbolt latch.

3. INSTALL DEADBOLT LATCH

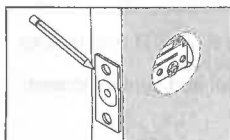

Insert latch in hole, keeping latch face parallel to face of door edge. Mark outline and remove latch.

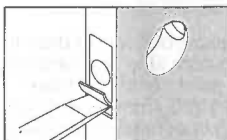

Chisel 1/8" (3mm) deep or until latch face is flush with door edge.

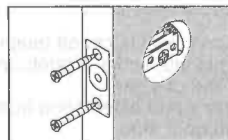

Install latch and tighten two screws firmly.



4. INSTALL THUMB TURN ASSEMBLY

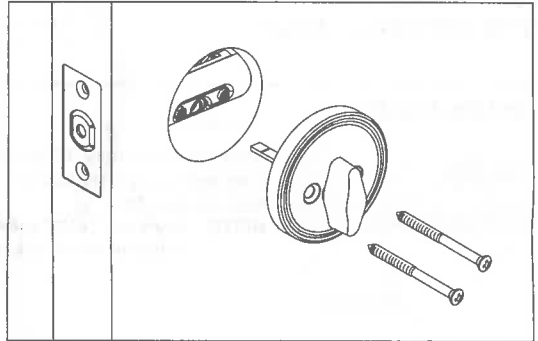
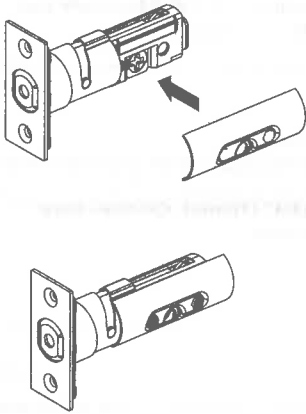

Mount thumb turn assembly on door, aligning onto latch crank, tighten screw firmly to secure assemblies to door.

5. INSTALL STRIKE PLATE

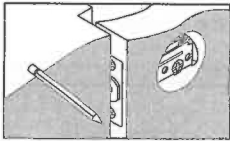

Close door until latchbolt touches jamb to locate strike in jamb and center line of strike. Open door and extend line from make to door stop.

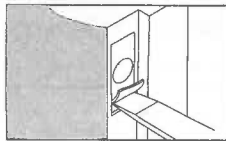

Measure one half of door thickness from door stop and vertically make drill point center for strike. Drill 1" (25.4mm) hole 1" (25.4mm) deep in door jamb for strike.

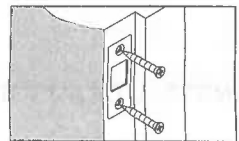

Chisel 1/16" (1.5mm) deep for strike. Install and tighten screws.

TEMPLATE

FOLD HERE ON DOOR EDGE



Drill 1" (25.4mm) hole 4-1/8" (105mm) deep in center of door edge.

Ø2-1/8" (54mm) hole
1-3/16" (31mm) deep

2-3/8" (60mm) BACKSET

2-3/4" (70mm) BACKSET



VERIFY IF PRINTED DIMENSIONS ARE TO SCALE PRIOR TO USE