

DOREX[®]

DGS
WEATHER STRIPPING AND GASKETING

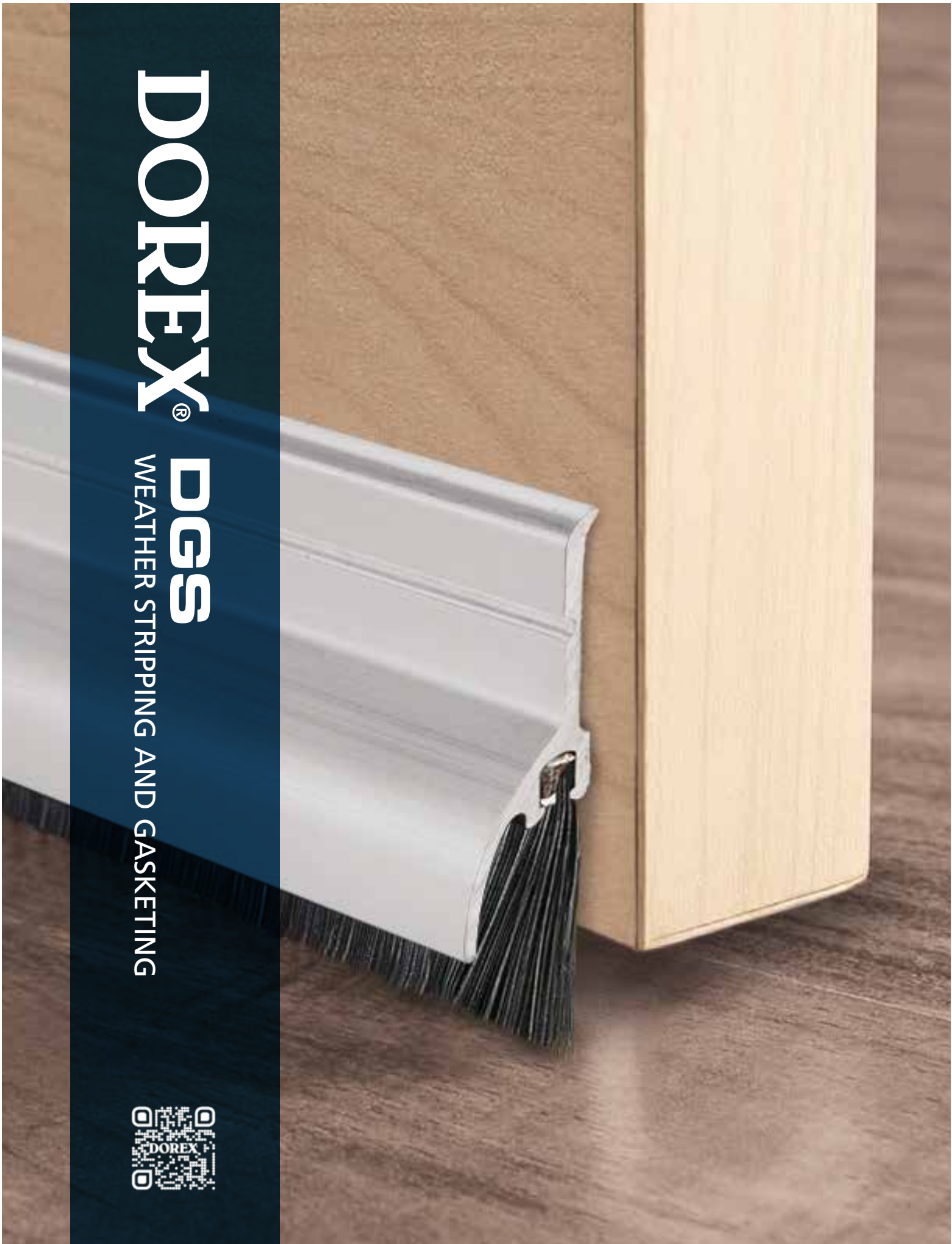

DOOR SWEEPS - NYLON



DOOR SWEEP WITH NYLON BRUSH

- DGS-WAD380B-36MILL ALUMINIUM 36"
- DGS-WAD380B-48MILL ALUMINIUM 48"
- DGS-WDD380B-36DARK BRONZE 36"
- DGS-WDD380B-48DARK BRONZE 48"



- cULus listed (UL10C)
 - » Wood fire door: 20 min
 - » Composite fire door: 90 min
 - » Metal fire door: 3 hrs
- Surface mounted
- Reduces infiltration of drafts, moisture, air, insects, and dust
- Extruded aluminum profile
- Flexible nylon brush conforms to surface irregularities
- Remains flexible between -40 to 205°C (-40 to 401°F)
- Can be cut to required length
- Includes screws for wood and metal doors

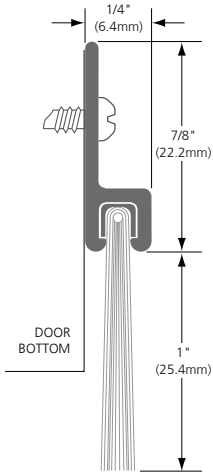

DOOR SWEEP WITH NYLON BRUSH AND RAIN DRIP

- DGS-WAR480B-36MILL ALUMINIUM 36"



- cULus listed (UL10C)
 - » Wood fire door: 20 min
 - » Composite fire door: 90 min
 - » Metal fire door: 3 hrs
- Surface mounted
- Reduces infiltration of drafts, moisture, air, insects, and dust
- Rain drip deflects water and prevents seepage through the gap under doors
- Extruded aluminum profile
- Flexible nylon brush conforms to surface irregularities
- Remains flexible between -40 to 205°C (-40 to 401°F)
- Can be cut to required length
- Includes screws for wood and metal doors

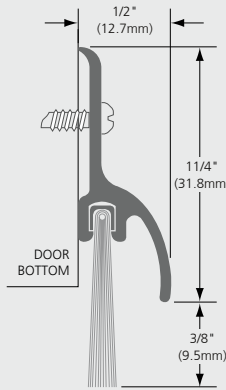

DOOR SWEEPS - NEOPRENE



DOOR SWEEP WITH NEOPRENE SEAL

- DGS-WA210N-36MILL ALUMINIUM 36"
- DGS-WA210N-48MILL ALUMINIUM 48"
- DGS-WD210N-36DARK BRONZE 36"
- DGS-WD210N-48DARK BRONZE 48"



- cULus listed (UL10C)
 - » Metal fire door: 3 hrs
- Surface mounted
- Reduces infiltration of drafts, moisture, air, insects, and dust
- Extruded aluminum profile
- Neoprene blade
- Remains flexible between -20 to 50°C (-4 to 122°F)
- Can be cut to required length
- Includes screws for wood and metal doors

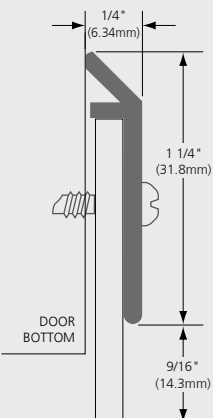

DOOR ASTRAGAL



T-ASTRAGAL

- DGS-AA158V-7MILL ALUMINIUM 7"



- cULus listed (UL10C)
 - » Metal fire door: 3 hrs
- Surface mounted on the beveled door edge of the active door of paired doors
- Provides a general-purpose weather seal
- Extruded aluminum profile
- Eco-friendly, bio-based gasket
- Can be cut to required length
- Includes screws for wood and metal door frames
- Door coordinator may be required when using two active doors
- Temperature range -5 to 60°C (-23 to 140°F)

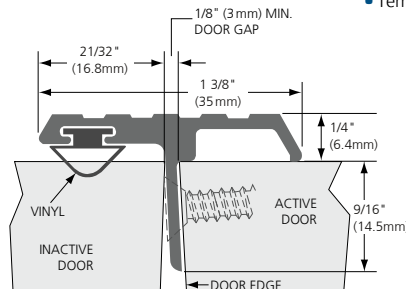

DOOR BOTTOMS



**AUTOMATIC DOOR BOTTOMS,
HOLLOW METAL DOORS**
DGS-BA32V-36ANODIZED ALUMINUM 36"



- cULus listed (UL10C)
 - » Wood fire door: 20 min
 - » Composite fire door: 90 min
 - » Metal fire door: 3 hrs
- Automatic door bottom for hollow metal doors with inverted channel
- Door seal will lower automatically as the door closes
- Extruded aluminum rail
- Non handed
- Maximum drop: 1/2" (12.7 mm), recommended gap is 3/8" (9.5 mm)
- Door thickness: 1 3/4" (44.5 mm)
- Channel depth: 3/4" (19 mm)
- Dual vinyl gaskets provide an excellent general-purpose seal
- Door drop can accommodate even and uneven surfaces
- Can be trimmed
- Does not include end-caps, requires a hole for the plunger to extend through the hinge side of the door edge
- Includes self drilling screws for metal and wood doors

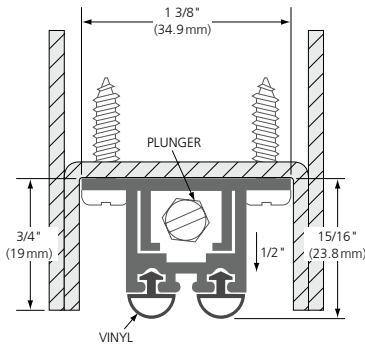

**AUTOMATIC DOOR BOTTOMS,
WOOD DOORS**
DGS-BA50N-36ANODIZED ALUMINUM 36"



- cULus listed (UL10C)
 - » Wood fire door: 20 min
 - » Composite fire door: 90 min
 - » Metal fire door: 3 hrs
- Automatic door bottom for wood door and mortised channel
- Door seal will lower automatically as the door closes
- Extruded aluminum rail
- Non handed
- Maximum drop: 3/4" (19 mm)
- Door thickness: 1 3/8-1 3/4" (35-44.5 mm)
- Recommended channel depth: 1 1/2" (38 mm), width: 1 9/32" (15 mm)
- Neoprene gasket provides an excellent general-purpose seal
- Door drop can accommodate even and uneven surfaces
- Can be trimmed
- Includes endcaps and screws for metal and wood doors
- On fire doors, the door bottom mortise preparation must be done by the door manufacturer

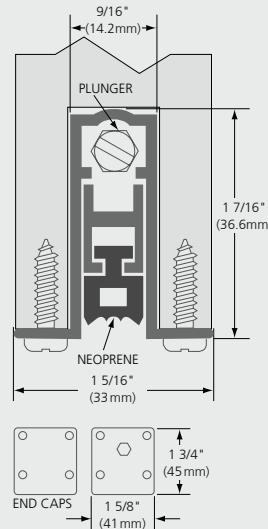

PERIMETER GASKETS



PERIMETER GASKETING
DGS-SA14V-17 MILL ALUMINIUM 17"



- cULus listed (UL10C)
 - » Wood fire door: 20 min
 - » Composite fire door: 90 min
 - » Metal fire door: 3 hrs
- Surface mounted
- For use on a wood or metal door frame of a 3x7ft (91.4x213.4cm) door
- For gaps between 1/16-1/4" (2-6mm)
- Temperature range: -35 to 120°C (-31 to 248°F)
- Extruded aluminum profile
- Vinyl gasket, provides an excellent general-purpose seal
- Can be installed on the face of a door to fill gaps between paired doors
- Slotted holes for easy adjustment
- Can be cut to required length
- Includes screws for wood and metal door frames
- Supplied in 3 pieces: 2x7 ft (213.4 cm) 1x3 ft (91.4 cm)

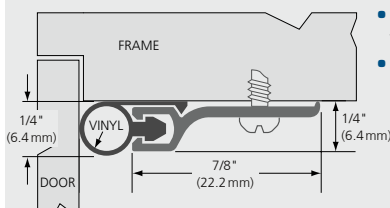
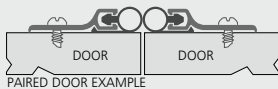

ADHESIVE GASKETING
DGS-SB12S-17BLACK 17"



- cULus listed (UL10C)
 - » Wood fire door: 20 min
 - » Composite fire door: 90 min
 - » Metal fire door: 3 hrs
- Silicone gasket with permanent adhesive strip
- Surface mounted
- For use on wood or metal door frames
- Compresses to fill gaps between 1/16-1/4" (2-6 mm)
- Provides an excellent general-purpose seal
- Extruded high-temperature silicone, self-extinguishing and non-toxic
- Effective between -50 to 232°C (-58 to 450°F)
- Impervious to fungus, mold, and mildew
- Unaffected by sunlight, ozone, and ultraviolet rays
- Coil length of 17ft (50.8cm) is sufficient for a door frame for a 3x7ft (91.4x213.4cm) door
- Can be cut to required length
- Other lengths available by special order

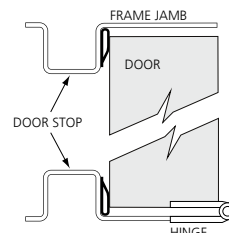
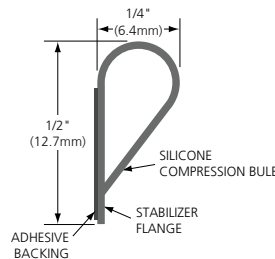

DOREX[®]
The Reliable Choice

