

**DOREX<sup>®</sup>**



**DX2**

**GRADE 1 EXIT DEVICES  
NARROW STILE**

# DX2

The DX2 Series Narrow Head Exit Devices are designed and manufactured for simplicity, strength, durability, aesthetics and installer-friendly innovations.

- Devices and trims are designed for new or retrofit installation into other manufacturers' exit devices and trims.
- Made to comply with the highest safety and security standards in the industry.
- cULus listed for Panic Exit Hardware or 3-hour Fire Rated Exit Hardware.
- Certified ANSI/BHMA A156.3-2014 Grade 1.

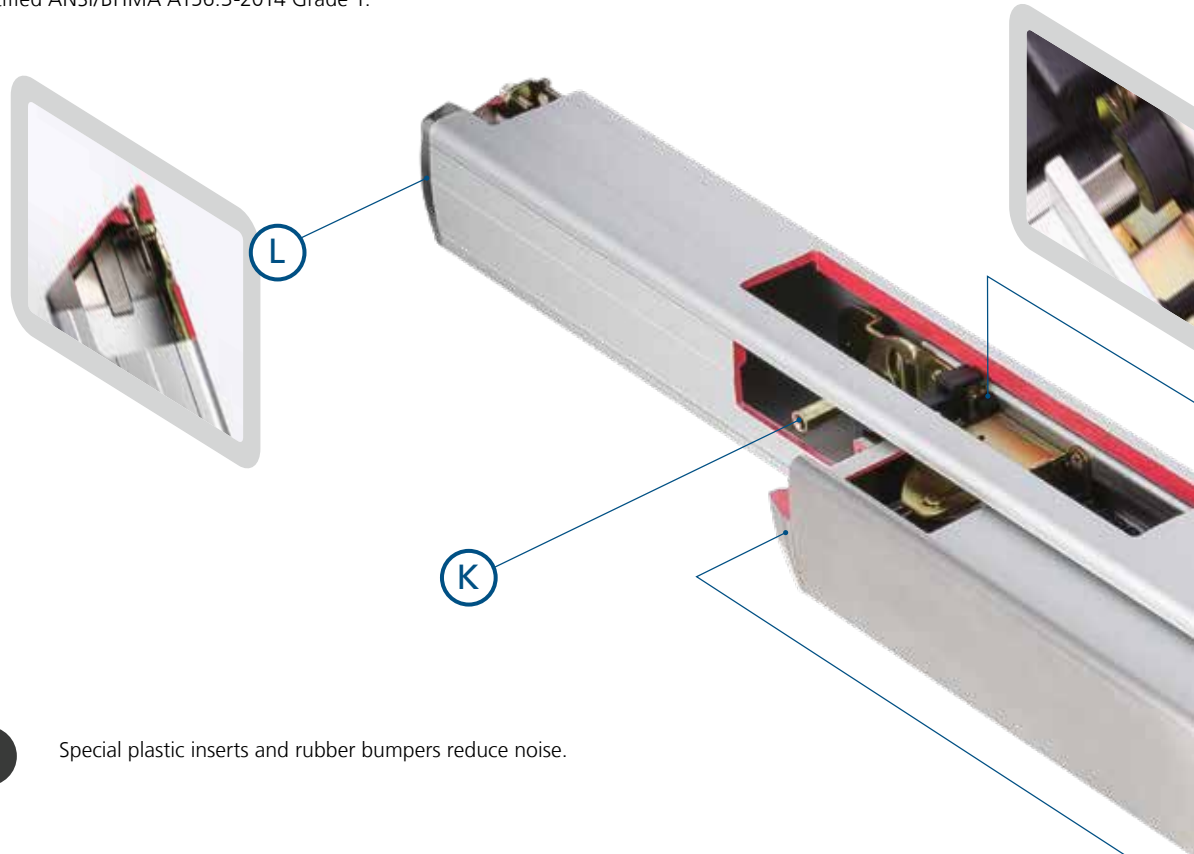

- A** Special plastic inserts and rubber bumpers reduce noise.
- B** Detachable center case allows switching between mechanical and electrical options which replaces the need of buying two complete sets.
- C** Center case with maximum versatility, surface and concealed vertical rods can be adjusted inside the center case with an ingenious rod holder design.
- D** Cross spindle offers additional strength.
- E** Replaceable cam breaks at a predetermined load to prevent further damage of the trim mechanism. Handing change is simple and easy.
- F** Center Case mounting plate made of heavy gauge steel adding extra strength.
- G** Stainless steel latch and security deadlatch.

**J**



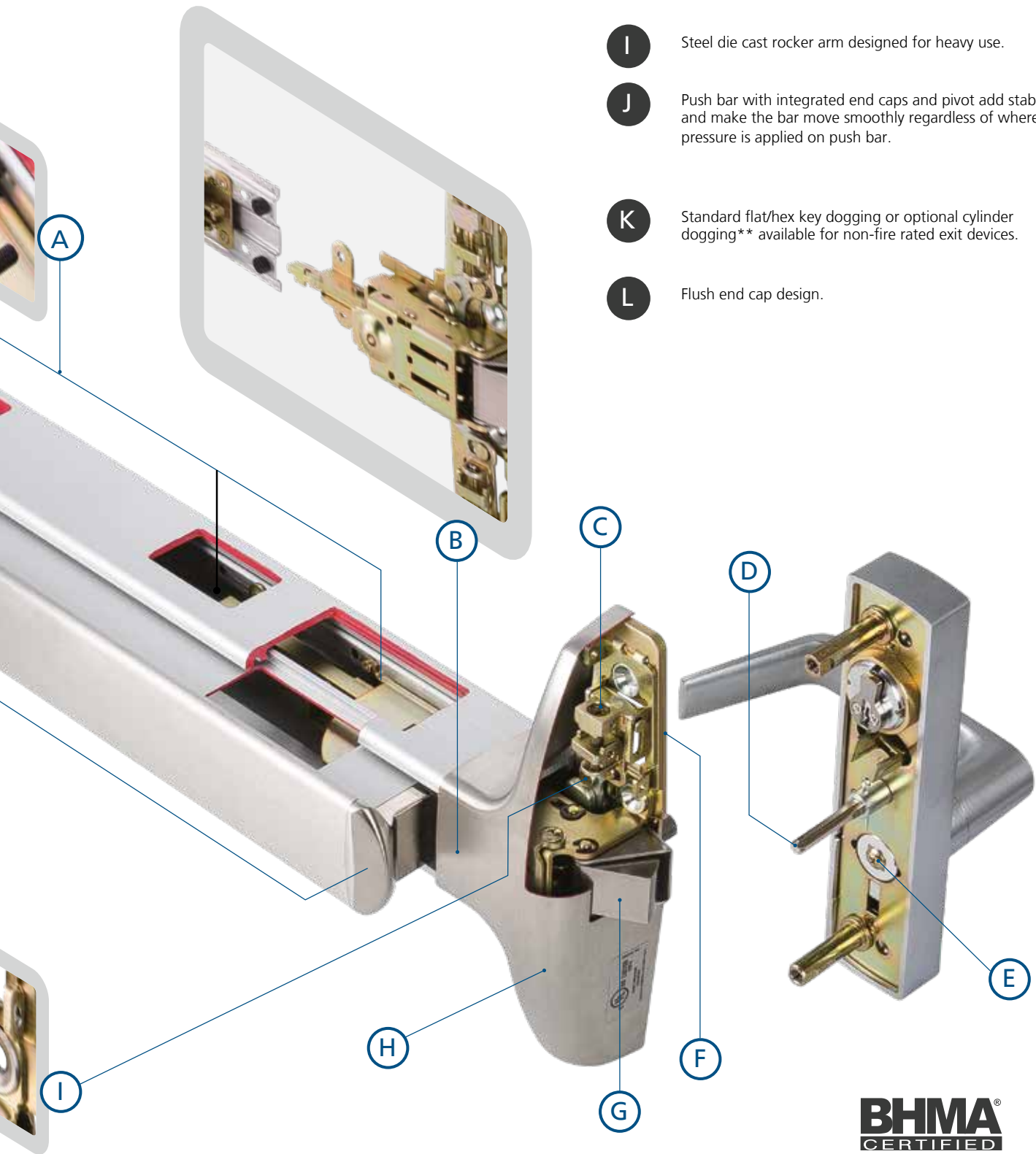

**H**

Center Case fits minimum 2" stile.

**I**

Steel die cast rocker arm designed for heavy use.

**J**

Push bar with integrated end caps and pivot add stability and make the bar move smoothly regardless of where the pressure is applied on push bar.

**K**

Standard flat/hex key dogging or optional cylinder dogging\*\* available for non-fire rated exit devices.

**L**

Flush end cap design.

**BHMA**<sup>®</sup>  
CERTIFIED

**UL**<sup>®</sup> US  
LISTED

\* SPECIAL ORDER – WILL REQUIRE ADDITIONAL LEAD TIME AND MINIMUM ORDER QUANTITIES.

\*\* CYLINDERS SOLD SEPARATELY

# General Overview

## Device Material

DX2 Series ext devices are furnished standard with a smooth case. Models with a grooved case are available. The two styles are mechanically and dimensionally identical and come with a wide selection of finishes.



## Finishes

Color	ANSI/BHMA	US	Part Material & Finish:		
			B / E / G	A / D	C / F / H
Satin Stainless Steel	630	32D	Stainless Steel, Satin	Plated	Anodized <sup>1</sup>
Satin Chrome*	626	26D	Brass, Satin & Plated	Plated	Anodized <sup>1</sup>
Polished Chrome*	625	26	Brass, Polished & Plated	Plated	Buffed Anodized <sup>1</sup>
Oil Rubbed Bronze*	613	10B	Bronze, Satin; Dark Oxidized	Plated	Anodized <sup>1</sup>
Satin Bronze*	612	10	Bronze, Satin	Plated	Anodized <sup>1</sup>
Polished Bronze*	611	9	Bronze, Polished	Plated	Buffed Anodized <sup>1</sup>
Satin Brass*	606	4	Brass, Satin	Plated	Anodized <sup>1</sup>
Polished Brass*	605	3	Brass, Polished	Plated	Buffed Anodized <sup>1</sup>

(\*) Special order finish, will require additional lead time and minimum order quantities. (1) Aluminum material  
NOTE: Non-listed finishes are available—please contact your sales representative.

### (B) Push Bar Options<sup>†</sup>:

- Embossed "PUSH"
  - Braille, embossed "CAUTION STAIRWELL"
  - Red silk screen lettered "EMERGENCY EXIT ONLY - PUSH TO OPEN & SOUND ALARM"
- (†) Please contact sales representative prior to ordering.



## Functions

ANSI/BHMA Number	Operation	Trim Option	
		<i>DX2TP Series Pull Trim</i>	<i>DX2TE Series Escutcheons</i>
01	Exit only, blank escutcheon or plate.	<i>DX2TPR01*</i>	N
02	Entrance by trim when bar is locked down/dogged.	<i>DX2TPR02*</i>	<i>DX2TER02*</i>
03	Entrance by trim. Key retracts latch. Key removable only when locked. (Night Latch)	<i>DX2TPR03*</i>	<i>DX2TER03*</i>
08	Entrance by knob/lever. Key locks or unlocks knob/lever.	N	<i>DX2TER08</i>
09	Entrance by knob/lever only when released by key. Key removable only when locked. (Night Latch)	N	<i>DX2TER09</i>
11	Entrance by thumb turn. Key locks or unlocks thumb turn.	N	<i>DX2TER11*</i>
12	Entrance by thumb turn only when released by key. Key removable only when locked. (Night Latch)	N	<i>DX2TER12*</i>
14	Entrance by trim when latch is released by knob/lever.	N	<i>DX2TER14*</i>
16	Entrance by trim when latch is released by thumb turn.	N	<i>DX2TER16*</i>

See pages 13–17 for more details.

# Dimensions

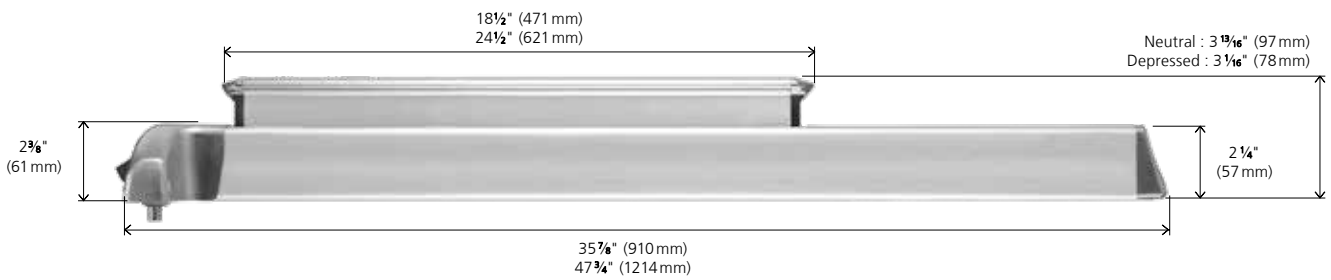

## Pull Trim

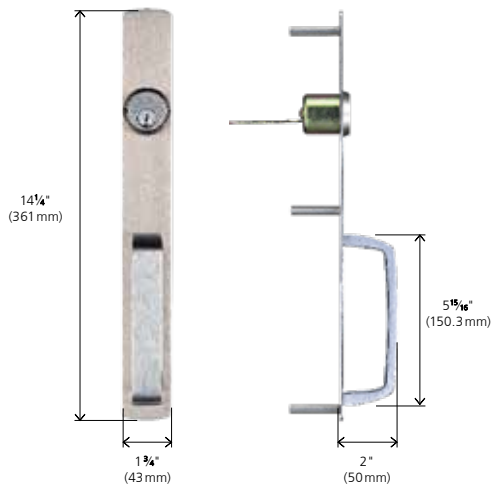

## Escutcheon

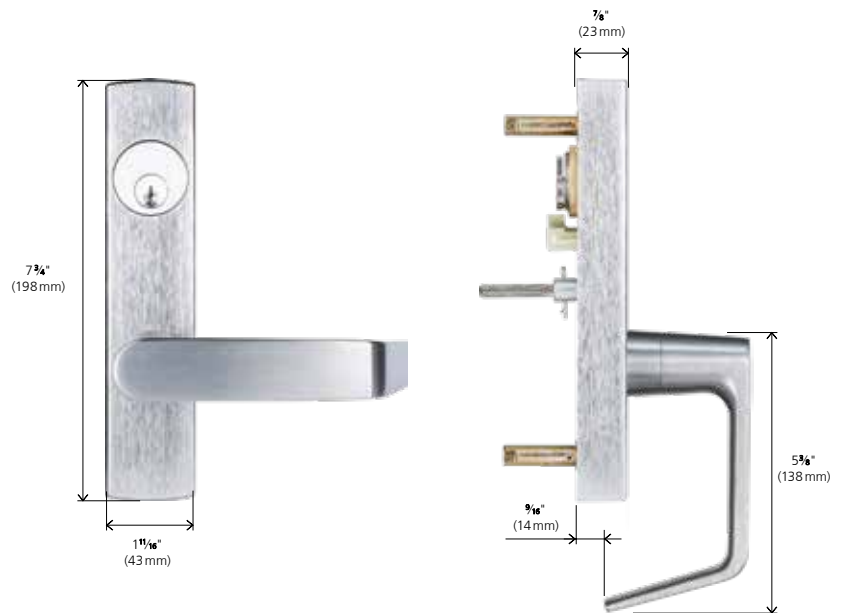



- Certifications**
- Certified ANSI/BHMA A156.3-2014, Grade 1
  - cULus listed for Panic Hardware
  - cULus listed for 3hr Fire Exit Hardware
  - Complies with NFPA 80 Fire doors

- Center Case & Rail Assembly**
- Heavy wrought steel center case
  - Adjustments accessible through center case after installation
  - Aluminum rail assembly, field sizeable

- Handing**
- Non-handed

- Door Width**
- 30–38" (762–965 mm)
  - 36–48" (914–1219 mm) – option\*

- Door Height**
- 7–8 ft (2134–2438 mm) – standard

- Door Thickness**
- 1 3/4–2 1/4" (45–57 mm) – standard

- Center Latch**
- Stainless steel, 3/4" (19 mm) throw
  - Deadlocking

- Strike**
- PANIC: Steel, roller type #DXAS103 –standard
  - FIRE: Steel, roller type #DXAS108F –standard

See DX2 Accessories, p. 19–22.

- Dogging**
- NOT available on FIRE EXIT hardware
  - Flat key dogging – standard
  - Cylinder dogging – option\*

- Cylinder**
- NOT included, sold separately
- See DX2 Cylinders, p. 23.

- Mounting Hardware**
- Machine and wood screws – standard
  - Sex nut & thru-bolts – standard<sup>1</sup>
  - Shims – standard

(1) With fire model. Required for fire-rated wood or composite doors and non-reinforced hollow metal doors  
See DX2 Accessories, p. 19–22.

- Electrical Options\***
- Alarm kit
  - Delayed egress
  - Electronic latch retraction
  - Latchbolt monitoring
  - Request to exit
  - Signal switch

(\*) Special order. See DX2 Electrical, p. 25–29.

- Trims**
- Compatible trims sold separately, easy to mix and match
- See DX2 Trims, p. 13–17.

- Finish**
- 630–Satin Stainless Steel

Other finishes available by special order, see p. 4.



**BHMA**  
CERTIFIED

**G1**

**UL**  
LISTED

**3H**

- Certifications**
- Certified ANSI/BHMA A156.3-2014, Grade 1
  - cULus listed for Panic Hardware
  - cULus listed for 3hr Fire Exit Hardware
  - Complies with NFPA 80 Fire doors

- Center Case & Rail Assembly**
- Heavy wrought steel center case with top and bottom rod adjusters.
  - Adjustments accessible through center case after installation
  - Aluminum rail assembly, field sizeable

- Handing**
- Non-handed

- Door Width**
- 30–38" (762–965 mm)
  - 36–48" (914–1219 mm) – option\*

- Door Height**
- 7 ft (2134 mm) – standard
  - 8 ft (2468 mm) – option\*
  - 10 ft (3048 mm) – option\*

See DX2 Accessories, p. 19–22.

- Door Thickness**
- 1 3/4–2 1/4" (45–57 mm) – standard

- Top Latch**
- Stainless steel, Pullman type, 5/8" (16 mm) throw
  - Deadlocking
  - Case : 4 1/2 x 2 1/8 x 1 1/2" (114 x 54 x 38 mm)

- Bottom Latch**
- Stainless steel, Pullman type, 5/8" (16 mm) throw
  - Deadlocking
  - Round slide bolt – available<sup>1\*</sup>
  - Case : 4 1/2 x 2 1/8 x 1 1/2" (114 x 54 x 38 mm)

(1) Panic only, not UL listed. Certified Grade 2.

- Fire Latch**
- Available for door openings 8 ft (2438 mm) wide x 8 ft (2438 mm) high
  - Included with Less Bottom Rod (L) option

See DX2 Accessories, p. 21.

- Strikes**
- PANIC
    - » Top: Steel, roller type #DXAS203 –standard
    - » Bottom: Steel, #DXAS227 –standard
  - FIRE
    - » Top: Steel, roller type #DXAS108F –standard
    - » Bottom: Steel, #DXAS227F –standard

See DX2 Accessories, p. 19–22.

- Dogging**
- NOT available on FIRE EXIT hardware
  - Flat key dogging – standard
  - Cylinder dogging – option\*

- Cylinder**
- NOT included, sold separately

See DX2 Cylinders, p. 23.

- Mounting Hardware**
- Machine and wood screws – standard
  - Sex nut & thru-bolts – standard<sup>1</sup>
  - Shims – standard

(1) With fire model. Required for fire-rated wood or composite doors and non-reinforced hollow metal doors.

See DX2 Accessories, p. 19–22.

- Electrical Options\***
- Alarm kit
  - Delayed egress
  - Electronic latch retraction
  - Latchbolt monitoring
  - Request to exit
  - Signal switch

(\*) Special order. See DX2 Electrical, p. 25–29.

- Trims**
- Compatible trims sold separately, easy to mix and match - See DX2 Trims, p. 13–17.

- Finish**
- 630–Satin Stainless Steel

Other finishes available by special order, see p. 4.



- Certifications**
- Certified ANSI/BHMA A156.3-2014, Grade 1
  - cULus listed for Panic Hardware
  - cULus listed for 3hr Fire Exit Hardware
  - Complies with NFPA 80 Fire doors

- Center Case & Rail Assembly**
- Heavy wrought steel center case with top and bottom rod adjusters.
  - Adjustments accessible through center case after installation
  - Aluminum rail assembly, field sizeable

- Handing**
- Non-handed

- Door Width**
- 30–38" (762–965 mm)
  - 36–48" (914–1219 mm) – option\*

- Door Height**
- 7 ft (2134 mm) – standard
  - 8 ft (2468 mm) – option\*
  - 10 ft (3048 mm) – option\*

See DX2 Accessories, p. 19–22.

- Door Thickness**
- 1 3/4–2 1/4" (45–57 mm) – standard

- Top Latch**
- Stainless steel, Pullman type, 5/8" (16 mm) throw
  - Deadlocking
  - Case : 4 1/2 x 2 1/8 x 1 1/2" (114 x 54 x 38 mm)

- Bottom Latch**
- Stainless steel, Pullman type, 5/8" (16 mm) throw
  - Deadlocking
  - Round slide bolt – available<sup>1</sup>\*
  - Case : 4 1/2 x 2 1/8 x 1 1/2" (114 x 54 x 38 mm)

(1) Panic only, not UL listed. Certified Grade 2.

- Fire Latch**
- Available for door openings 8 ft (2438 mm) wide x 8 ft (2438 mm) high
  - Included with Less Bottom Rod (L) option

See DX2 Accessories, p. 21.

- Strikes**
- PANIC
    - » Top: Steel, #DXAS216 –standard
    - » Bottom: Steel, #DXAS227 –standard
  - FIRE
    - » Top: Steel, #DXAS216 –standard
    - » Bottom: Steel, #DXAS227F –standard
- See DX2 Accessories, p. 19–22.

- Dogging**
- NOT available on FIRE EXIT hardware
  - Flat key dogging – standard
  - Cylinder dogging – option\*

- Cylinder**
- NOT included, sold separately
- See DX2 Cylinders, p. 23.

- Mounting Hardware**
- Machine and wood screws – standard
  - Sex nut & thru-bolts – standard<sup>1</sup>
  - Shims – standard

(1) With fire model. Required for fire-rated wood or composite doors and non-reinforced hollow metal doors

See DX2 Accessories, p. 22.

- Electrical Options\***
- Alarm kit
  - Delayed egress
  - Electronic latch retraction
  - Latchbolt monitoring
  - Request to exit
  - Signal switch

(\*) Special order. See DX2 Electrical, p. 25–29.

- Trims**
- Compatible trims sold separately, easy to mix and match - See DX2 Trims, p. 13–17.

- Finish** 630–Satin Stainless Steel
- Other finishes available by special order, see p. 4.



- Certifications**
- Certified ANSI/BHMA A156.3-2014, Grade 1
  - cULus listed for Panic Hardware
  - cULus listed for 3hr Fire Exit Hardware
  - Complies with NFPA 80 Fire doors

- Center Case & Rail Assembly**
- Heavy wrought steel center case with top and bottom rod adjusters.
  - Adjustments accessible through center case after installation
  - Aluminum rail assembly, field sizeable

- Handing**
- Non-handed

- Door Width**
- 30–38" (762–965 mm)
  - 36–48" (914–1219 mm) – option\*

- Door Height**
- 7 ft (2134 mm) – standard
  - 8 ft (2468 mm) – option\*
  - 10 ft (3048 mm) – option\*

See DX2 Accessories, p. 19–22.

- Door Thickness**
- 1 3/4– 2 1/4" (45–57 mm) – standard

- Center Latch**
- Stainless steel, deadlocking, 3/4" (19 mm) throw

- Top Latch**
- Stainless steel, Pullman type, 5/8" (16 mm) throw
  - Deadlocking
  - Case : 4 1/2 x 2 1/8 x 1 1/2" (114 x 54 x 38 mm)

- Bottom Latch**
- Stainless steel, Pullman type, 5/8" (16 mm) throw
  - Deadlocking
  - Round slide bolt – available<sup>1\*</sup>
  - Case : 4 1/2 x 2 1/8 x 1 1/2" (114 x 54 x 38 mm)

(1) Panic only, not UL listed. Certified Grade 2.

- Fire Latch**
- Available for door openings 8 ft (2438 mm) wide x 8 ft (2438 mm) high
  - Included with Less Bottom Rod (L) option

See DX2 Accessories, p. 21.

- Strikes**
- PANIC
    - » Top: Steel, roller type #DXAS203 –standard
    - » Middle: Steel, roller type #DXAS103 –standard
    - » Bottom: Steel, #DXAS227 –standard
  - FIRE
    - » Top/Middle: Steel, roller type #DXAS108F –standard
    - » Bottom: Steel, #DXAS227F –standard

See DX2 Accessories, p. 19–22.

- Dogging**
- NOT available on FIRE EXIT hardware
  - Flat key dogging – standard
  - Cylinder dogging – option\*

- Cylinder**
- NOT included, sold separately
- See DX2 Cylinders, p. 23.

- Mounting Hardware**
- Machine and wood screws – standard
  - Sex nut & thru-bolts – standard<sup>1</sup>
  - Shims – standard

(1) With fire model. Required for fire-rated wood or composite doors and non-reinforced hollow metal door  
See DX2 Accessories, p. 19–22.

- Electrical Options\***
- Alarm kit
  - Delayed egress
  - Electronic latch retraction
  - Latchbolt monitoring
  - Request to exit
  - Signal switch

(\*) Special order. See DX2 Electrical, p. 25–29.

- Trims**
- Compatible trims sold separately, easy to mix and match - See DX2 Trims, p. 13–17.

- Finish**
- 630–Satin Stainless Steel

Other finishes available by special order, see p. 4.

# Fire Door

## Maximum Door Opening Applications and Listings

Exit Device	Door Material	Single Door	Double Door		
			With mullion	2x Vertical Rod Same Direction	2x Vertical Rod Double Egress
DX2 FR RIM	Metal	3 Hours 4' x 8'	3 Hours 8' x 8'		
DX2 FV SVR	Metal	3 Hours 4' x 8'		3 Hours 8' x 8'	3 Hours 8' x 8'
DX2 FVL LBR	Metal	3 Hours 4' x 8'		3 Hours 8' x 8'	3 Hours 8' x 8'
DX2 FC CVR	Metal	3 Hours 4' x 8'		3 Hours 8' x 8'	3 Hours 8' x 8'
DX2 FCL LBR	Metal	3 Hours 4' x 8'		3 Hours 8' x 8'	3 Hours 8' x 8'
DX2 FW 3PT	Metal	3 Hours 4' x 8'	3 Hours 8' x 8'		

Metric conversion: 4' (1219mm), 8' (2438mm), 10' (3048mm)

### Notes:

1. Fire exit device conforms to UL10C and UBC7-2.
2. Fire exit device is applicable for wood door with 1½-hour or 20-min fire rating.
3. Consult with door manufacturer for specific limitations on fire door assemblies.

## Strike Application / Minimum Stile Width

Exit Device	Single door*		Double door*	
	Strike	Minimum stile width	Strike with mullion**	Minimum stile width
DX2 PR RIM	DXAS103	2 1/8" (54mm)	DXAS103 with mullion	3 3/4" (95.3mm)
	DXAS106†	2 3/4" (70mm)	DXAS106 with mullion	3 3/4" (95.3mm)
DX2 PV SVR	DXAS203 (Top) DXAS227 (Bottom)	2 1/2" (63mm)	DXAS203 (Top) DXAS227 (Bottom)	2 7/8" (73mm)
	DXAS106† (Top) DXAS227 (Bottom)	2 3/4" (70mm)	DXAS106† (Top) DXAS227 (Bottom)	3 1/8" (79mm)
DX2 PC CVR	DXAS216 (Top) DXAS227 (Bottom)	2 1/8" (54mm)	DXAS216 (Top) DXAS227 (Bottom)	2 7/8" (60.3mm)
	DX2 PW 3PT	DXAS103 (Middle) DXAS203 (Top) DXAS227 (Bottom)	2 1/8" (54mm)	DXAS103 with mullion DXAS203 (Top) DXAS227 (Bottom)
DXAS106† (Middle) DXAS203 (Top) DXAS227 (Bottom)		3 1/2" (88.9mm)	DXAS106† with mullion DXAS203 (Top) DXAS227 (Bottom)	3 3/4" (95.3mm)
DX2 FR RIM	DXAS108F	3 1/2" (88.9mm)	DXAS108F with mullion	4" (101.4mm)
DX2 FV SVR	DXAS108F (Top) DXAS227F (Bottom)	2 1/2" (63.5mm)	DXAS108F (Top) DXAS227F (Bottom)	2 7/8" (73mm)
	DX2 FC CVR	DXAS216 (Top) DXAS227F (Bottom)	4 3/4" (120.7mm)	DXAS216 (Top) DXAS227F (Bottom)
DX2 FW 3PT	DXAS108F (Middle) DXAS108F (Top) DXAS227F (Bottom)	3 1/2" (88.9mm)	DXAS108F with mullion DXAS108F (Top) DXAS227F (Bottom)	4" (101.4mm)

†Alternative option. \*For reference only, stile width may vary due to strikes used, door frame type, and required backsets. Please contact your local representative for additional information and/or details.

\*\*Please contact representative for mullion details and options.

# Dogging

## What is dogging?

Dogging is a feature used in exit devices to hold the push pad or crossbar in a retracted position (holding the latch retracted), thus allowing a door to operate in push/pull mode without latching.

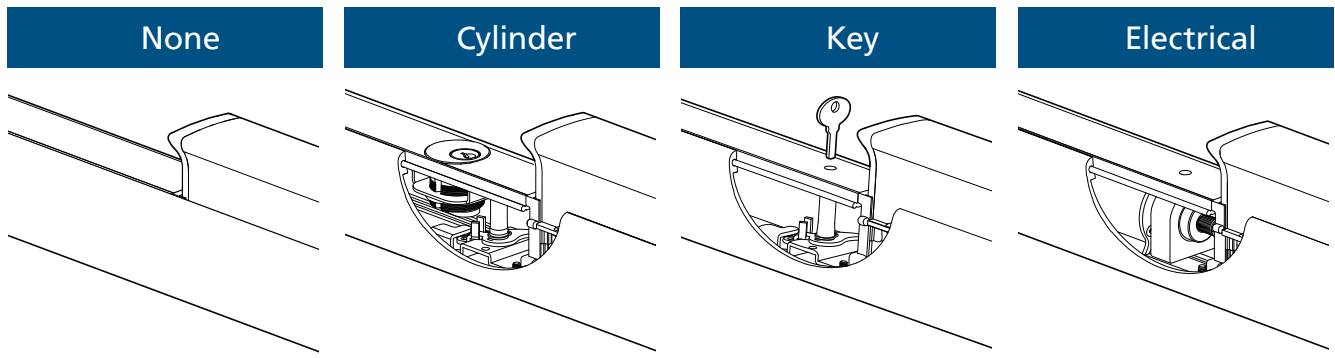

### Less or No Dogging

Less Dogging is available for all DX2 exit devices.

### Cylinder Dogging

Available for all models except for Fire Exit Hardware. Cylinder Dogging provides the ability to lock down the push bar with a key cylinder.

Requires the use of a 1 1/4" mortise cylinder that is not included and is sold separately.

DX2 Cylinder Dogging Kit  
 (#DX2AKD3LC - for 3ft devices).  
 (#DX2AKD4LC - for 4ft devices).

### Key Dogging

Available for all models except for Fire Exit Hardware. Key dogging provides the ability to lock down the push bar with an included flat key or appropriately sized flat-headed screw driver.

A replacement key (#DXADK) is also available.

### Electrical Dogging

Also known as Electrical Latch Retraction.

For details, see page 25.

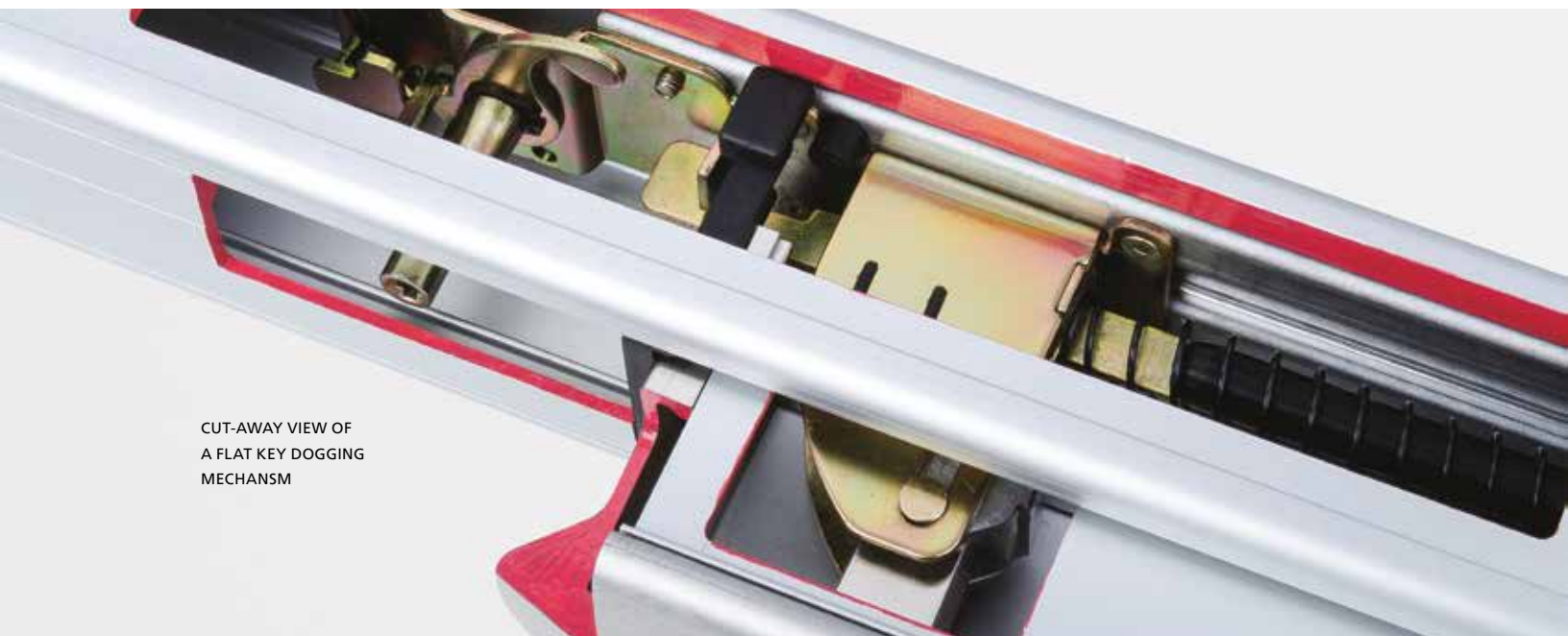

CUT-AWAY VIEW OF  
 A FLAT KEY DOGGING  
 MECHANISM

# DX2

## Trim Options

### DX2TP Series Pull Trims



Plate



Pull Only



With Cylinder

### DX2TE Series Escutcheon Trims



Lever



Thumb Turn



With Cylinder

# DX2TP Series Pull Trims



## Features

- Trims are furnished with wrought plate and extruded or with cast solid grips.
- Trims are designed to retrofit into other manufacturers' devices.
- Trims are UL/cUL certified for ANSI/BHMA A156.3-2014 Grade 1 and 3-Hour Fire Exit Hardware.
- Trims meet ADA requirements.
- Trims are through bolted.
- Satin stainless steel (630) finish – other finishes available.
- Specify handing when ordering
- Cylinder not included, see page 22.
- For Trim dimensions, see page 6.
- To order, see page 30.

## Grip Options

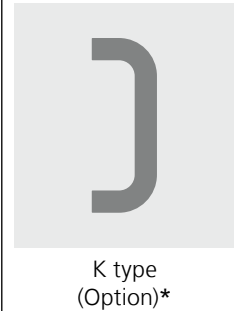
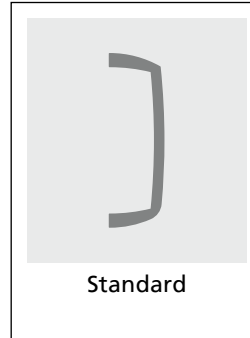

ANSI/BHMA	01	02	03
<b>Operation</b>	Exit only, blank escutcheon	Entrance by trim when actuating bar is locked down/dogged. (Dummy)	Entrance by trim when latch is released by key. Key removable only when locked. (Night Latch) *Cylinder collar required (not included)
<b>Trim No.</b>	<i>DX2TPR 01*</i>	<i>DX2TPR 02*</i>	<i>DX2TPR 03*</i>
<b>Cylinder Type</b>			RIM
<b>Device No.</b>	DX2 PR/FR DX2 PV/FV DX2 PC/FC DX2 PW/FW	DX2 PR/FR DX2 PV/FV DX2 PC/FC DX2 PW/FW	DX2 PR/FR DX2 PV/FV DX2 PC/FC DX2 PW/FW
<b>Specify Handing**</b>	YES	YES	YES

(\*\*) SPECIFY LHR/RHR WHEN ORDERING – SEE PAGE 30.

# DX2TE Series Escutcheon Trims



## Features

- Escutcheon and lever with sleek and seamless design produced by casting or forging.
- Trims are designed to retrofit into other manufacturers' devices.
- Handing field reversible.
- Trims are UL/cUL certified for ANSI/BHMA A156.3-2014 Grade 1 and 3-Hour Fire Exit Hardware.
- Trims meet ADA requirements.
- Cylinder not included, see page 22.
- Satin chrome (626) finish – other finishes available.
- For Trim dimensions, see page 6.
- To order, see page 30.



ANSI/BHMA	11	12	16
			
<b>Operation</b>	Entrance by thumb-turn. Key locks or unlocks thumb turn. (Storeroom)	Entrance by thumb-turn only when released by key. Key removable only when locked. (Night Latch)	Entrance by trim when latch is released by thumb-turn. (Passage)
<b>Trim No.</b>	<i>DX2TER 11*</i>	<i>DX2TER 12*</i>	<i>DX2TER 16*</i>
<b>Cylinder Type</b>	Mortise	Rim	
<b>Device No.</b>	DX2 PR/FR DX2 PV/FV DX2 PC/FC DX2 PW/FW	DX2 PR/FR DX2 PV/FV DX2 PC/FC DX2 PW/FW	DX2 PR/FR DX2 PV/FV DX2 PC/FC DX2 PW/FW
<b>Specify Handing</b>	NO	NO	NO

# DX2TE Series Escutcheon Trims



## Features

- Escutcheon and lever with sleek and seamless design produced by casting or forging.
- Trims are designed to retrofit into other manufacturers' devices.
- Handing field reversible.
- Trims are UL/cUL certified for ANSI/BHMA A156.3-2014 1 and 3-Hour Fire Exit Hardware.
- Trims meet ADA requirements.
- Cylinder not included, see page 22.
- Satin chrome (626) finish – other finishes available.
- Other lever styles available.
- For Trim dimensions see page 6.
- To order, see page 30.

ANSI/BHMA	02	03	08
			
<b>Operation</b>	Entrance by trim when actuating bar is locked down / dogged. (Dummy)	Entrance by trim when latch is released by key. Key removable only when locked. (Night Latch)	Entrance by lever. Key locks or unlocks lever. (Classroom)
<b>Trim No.</b>	<i>DX2TER02*</i>	<i>DX2TER03*</i>	<b>DX2TER08</b>
<b>Cylinder Type</b>		Rim	Mortise
<b>Device No.</b>	DX2 PR/FR DX2 PV/FV DX2 PC/FC DX2 PW/FW	DX2 PR/FR DX2 PV/FV DX2 PC/FC DX2 PW/FW	DX2 PR/FR DX2 PV/FV DX2 PC/FC DX2 PW/FW
<b>Specify Handing</b>	NO	NO	NO

### Lever Options

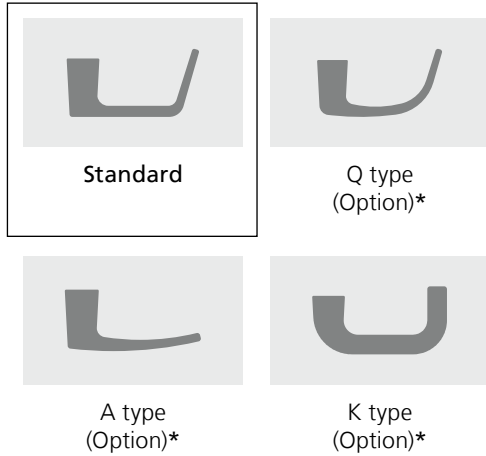

### Breakable Cam



*The DX2TEM (functions 08,11 only) trim includes an internal breakable cam which breaks when a predetermined load is applied to the outside thumb-turn or lever handle when locked without damaging the trim or compromising security. The cam can easily be replaced - #DXACED05.*

09	14
Entrance by lever only when latch is released by key. Key removable only when locked. (Night Latch)	Entrance by trim when latch is released by lever. Always active, no cylinder. (Passage)
<b>DX2TER09</b>	<b>DX2TER14*</b>
Rim	
DX2 PR/FR	DX2 PR/FR
DX2 PV/FV	DX2 PV/FV
DX2 PC/FC	DX2 PC/FC
DX2 PW/FW	DX2 PW/FW
NO	NO



# Accessories

## Rim Device -Strikes

**P** Panic Application  
**🔥** Fire Application



P/N. DXAS106  
 Rim Strike  
 Optional middle strike for DX2PR, DX2PW.  
 Optional top stike for DX2PV, DX2PW.  
**P**

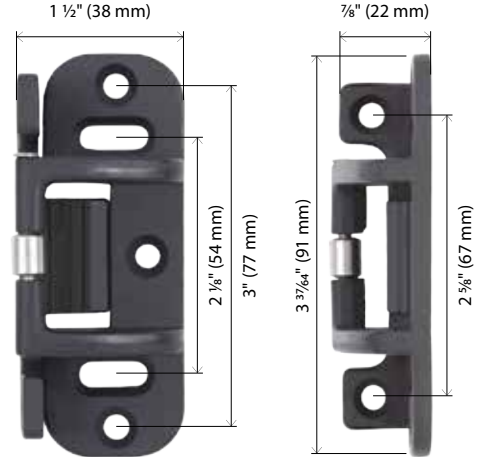

P/N. DXAS108F  
 Rim Strike with Strike Hook  
 Middle strike for DX2FR and DX2FW.  
 Top Strike for DX2FV, DX2FW. For  
 double door DX2FR/PR or DX2FW/PW  
 with mullion.  
**P** **🔥**



P/N. DXAS103  
 Rim Strike  
 Standard strike for DX2PR, DX2PW.  
 For double door DX2PR, DX2PW with mullion.  
**P**

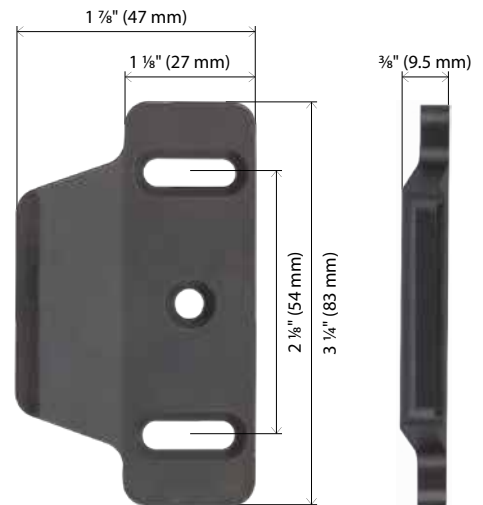

P/N. DXAS136\*  
 Overlapping Rim Strike  
 For DX2PR or DX2PW paired with DX2PV or  
 DX2PC in double door applications  
 with door coordinator and no mullion.  
**P**

# Accessories

## Vertical Rod (VR) Device - Strikes

**P** Panic Application  
**🔥** Fire Application

### Top Strike

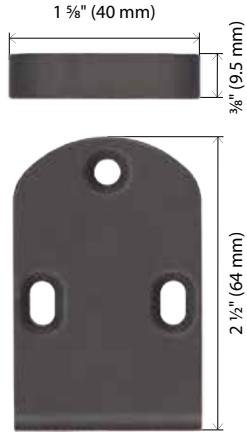

P/N. DXAS215\*  
 Top Strike  
 For flush transom  
 DX2PV/FV, DX2PW/FW.  
**P** **🔥**

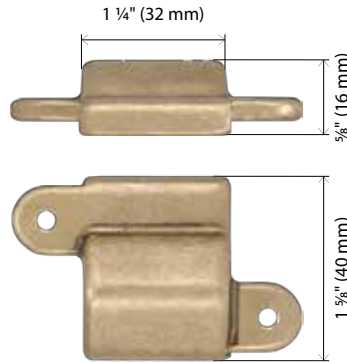

P/N. DXAS216  
 Top Strike  
 Standard for DX2PC/FC.  
**P** **🔥**

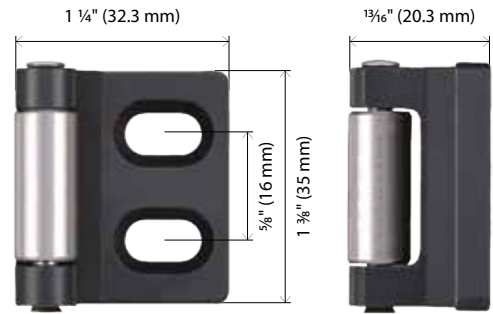

P/N. DXAS203  
 Top Strike  
 For DX2PV, DX2PW.  
**P**

## Vertical Rod (VR) Device - Bottom Strikes

### Round

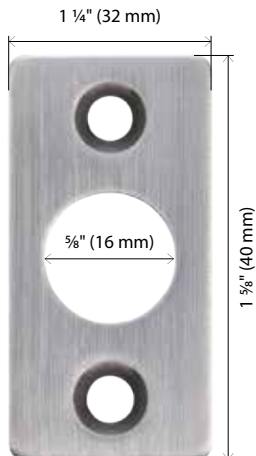

P/N. DXAS225\*  
 Bottom Strike  
 For DX2PV, DX2PC, DX2PW  
 with round slide bolt.  
 (Grade 2)  
**P**



P/N. DXAS226\*  
 Bottom Strike  
 Optional for DX2PV/FV,  
 DX2PC/FC, DX2PW/FW  
 round slide bolt.  
 (Grade 2)  
**P**

### Pullman

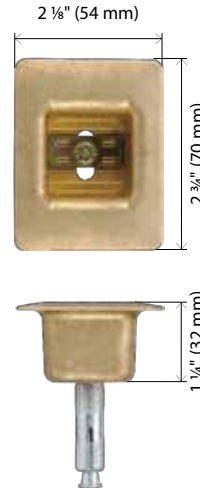

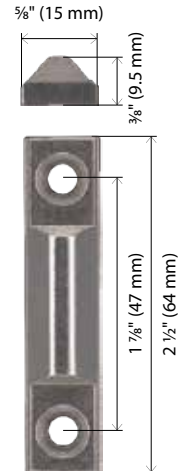

P/N. DXAS227/227F  
 Bottom Strike  
 Standard for DX2PV/FV,  
 DX2PC/FC, DX2PW/FW.  
**P** **🔥**



P/N. DXAS224\*  
 Bottom Strike  
 Optional for DX2PV and  
 DX2PW.  
 (Grade 2)  
**P**

# Accessories

 Panic Application  
 Fire Application

## Shims



*P/N. DXKG6010\**  
 For DXAS106 Rim Strike  
 Two (2) pieces furnished  
 standard



*P/N. DXKG6030\**  
 For DXAS108F Rim Strike  
 Two (2) pieces furnished  
 standard



*P/N. DXKG6050\**  
 For DX2PC/FC top & bottom latches  
 Sixteen (16) pieces furnished standard for Top and Bottom  
 latches. Eight (8) pieces furnished standard for LBR.



*P/N. DXKG8010\**  
 For DXAS103 Rim strike  
 Two (2) pieces furnished  
 standard



*P/N. DXKG8020\**  
 For DXAS203 Strike  
 Two (2) pieces furnished  
 standard

## Fastener/Sex Nut Bolts (SNB)



DXKB1024  
(No. 10-24)

DXKB4120  
(No. 1/4-20)

Specify Sex Nut Bolts (SNB) where recommended or when required by the door manufacturer.

Sex Nuts Bolts (SNB) are furnished with DXKB1024 (No. 10-24) for device or DXKB4120 (No. 1/4-20) for top rod latch and bottom rod latch. Can accommodate doors up to 2 1/4" (57 mm) thick.

	Devices No.	Specification	Qty.
<b>Without Trim</b>	DX2PR/FR	DXKB1024 (No.10-24)	2
		DXKB4120 (No.1/4-20)	2
	DX2PV/FV	DXKB1024 (No.10-24)	2
		DXKB4120 (No.1/4-20)	6
	DX2PC/FC	DXKB1024 (No.10-24)	2
		DXKB4120 (No.1/4-20)	2
DX2PW/FW	DXKB1024 (No.10-24)	2	
	DXKB4120 (No.1/4-20)	6	
<b>With Trim</b>	DX2PR/FR	DXKB1024 (No.10-24)	2
		DXKB4120 (No.1/4-20)	4
	DX2PC/FC	DXKB1024 (No.10-24)	2
		DXKB4120 (No.1/4-20)	4

## Auxiliary Fire Bolt/Latch





*P/N. DXAFL*  
 Heat activated. Used in Less Bottom Rod (L)  
 option for fire exit devices. Included when  
 ordering Less Bottom Rod (L) option.  
 For door openings up to (WXH) 8x8ft.



# Accessories

## Top Rods

	Part No.	Rod Length	
	DXAVRT020	36 1/8" (916mm)	Surface rod included with size 36 exit device
	DXAVRT030	48 1/8" (1221mm)	Surface rod included with size 48 exit device
	DXAVRT030 Add DXAVRT040†	48 1/8" (1221mm) Add 24" (609mm)	Extension rod, surface
	DX1ACRT070	37" (940mm)	Concealed rod included with size 37 exit device
	DX1ACRT080	49" (1245mm)	Concealed rod included with size 48 exit device
	DX2ACRT080 Add DX2ACRT050†	49" (1245mm) Add 23 7/8" (605mm)	Extension rod, concealed



## Top Rod Selection Guide

Door Width	Door Height	Device Size	Additional Surface Rod	Additional Concealed Rod
36in (914 mm)	7ft (213 cm)	37	none	none
36in (914 mm)	8ft (244 cm)	37	DXAVRT030 <sup>2</sup>	DXACRT080 <sup>2</sup>
36in (914 mm)	9ft (274 cm) <sup>1</sup> , 10ft (305 cm) <sup>1</sup>	37	DXAVRT030 <sup>2</sup> + DXAVRT040 <sup>3</sup>	DXACRT080 <sup>2</sup> + DXACCRT050 <sup>3</sup>
48in (1219 mm)	7ft (213 cm)	48	none <sup>3</sup>	none <sup>3</sup>
48in (1219 mm)	8ft (244 cm)	48	none	none
48in (1219 mm)	9ft (274 cm) <sup>1</sup> , 10ft (305 cm) <sup>1</sup>	48	DXAVRT040 <sup>3</sup>	DXACCRT050 <sup>3</sup>

(1) Not for use with fire-rated devices. (2) Replace included top rod. (3) Top rod may need to be cut and/or tapped to fit.

## Bottom Rods



For exit device location at 39 5/8" (1006mm) from finished floor

	Part No.	Rod Length	
	DXAVRB010	31 7/8" (807 mm)	Included with DX2 PV/FV DX2 FW/FW
	DX2ACRB010*	34 3/32" (870 mm)	Included with DX2 PC/FC

# Cylinders

Cylinders are not furnished standard with the device or trim and must be specified when required. Cylinders are Schlage® C keyway, 6-pin standard, and are available in satin chrome (626) finish. Interchangeable Cores (SFIC) are also available.

Please consult your local sales representative prior to specifying to ensure proper selection or for additional keying services.

Cylinder type	Trim Application	Exit Device Applications	Cylinder	Cyl. Length (Part/no.)	Cylinder Cam
<b>Mortise Cylinder</b> 	DX2TE	08 / 11 for DX2PR/FR, DX2PV/FV, DX2PC/FC, DX2PW/FW	Standard	1½" (MC118)	DXACB
			SFIC (6-pin) SFIC (7-pin)**	1¼" (DXAICMH114F†) 1⅝" (DXAICMH138F†)	F*
	All Devices	Cylinder Dogging or Electrified Function	Standard	1¼" (MC114)	DXACA
			SFIC	1⅝" (DXAICMH138E†)	E*
<b>Rim Cylinder</b> 	DX2TPR	03 for DX2PR/FR, DX2PV/FV, DX2PC/FC, DX2PW/FW (Must use with Cylinder Collar Part/No.817D)	Standard	2⅜" Tailpiece (MR118)	
			SFIC	1¾" Tailpiece (9807H)	
	DX2TE	03 / 09 / 12 for DX2PR/FR, DX2PV/FV, DX2PC/FC, DX2PW/FW	Standard	2⅜" Tailpiece (MR118)	
			SFIC	1¾" Tailpiece (9807H)	

† Special order - will require additional lead time and/or minimum order quantities.

\* Fixed cam, not available separately. \*\* 7-pin SFIC will require a cylinder guard (#DXACG1 or #DXACG2)

## Cylinder Cam

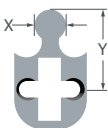
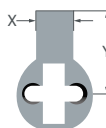
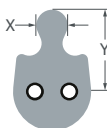
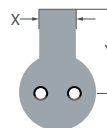
Cam No.	DXACA	DXACB	E*	F*
Illustration				
Dimension	X=0.250" (6 mm) Y=0.625" (15 mm)	X=0.375" (9.5 mm) Y=0.750" (19 mm)	X=0.250" (6 mm) Y=0.625" (15 mm)	X=0.375" (9.5 mm) Y=0.750" (19 mm)

\* Fixed cam, not available separately



### Cylinder Collar

P/N: 817D  
For use with DX2TPR03



### SFIC Core

Interchangeable cores are included with housings.

Specify, 6 or 7 pin, uncombined (0-bitted) or less core.

Please contact your local sales representative for details and keying services.



# Electrified

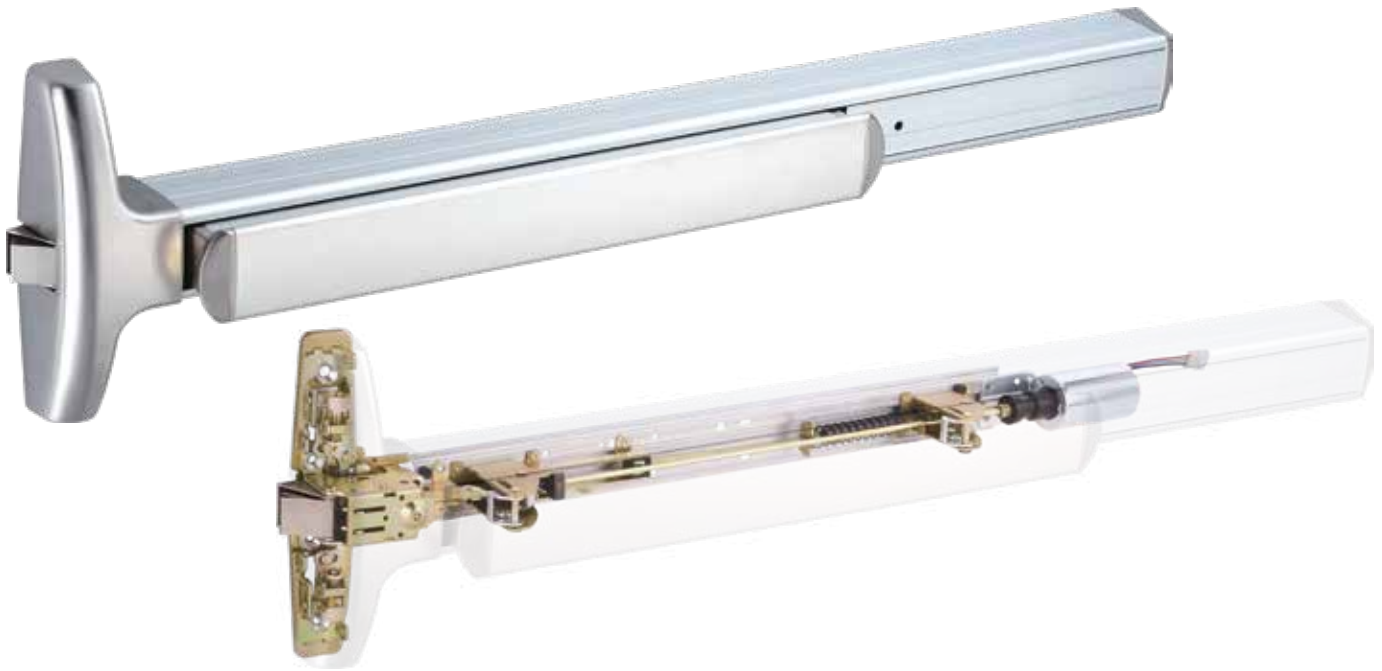

EL

## Electrical Latch Retraction / Dogging

Electrical Latch Retraction / Dogging (EL) provides the ability to retract the exit device latch. When a signal is sent to the device, either from a reader or from some other electric signal switch, the latch is retracted momentarily allowing the door to be pulled open.

The latch can also be held retracted for a longer period (electric dogging). This can be set up with the access control system so that the device is on a schedule. At the beginning of the day the latch can be retracted and held open for business hours and then released and secure for closing time at the end of the day.

The DX2 EL uses a solenoid to retract and hold the latch. When power is cut during a power failure, the solenoid releases the latch to secure the opening (Fail Secure).

A power supply and wire transfer are required (sold separately).

### Features:

- cULus Listed for Panic and Fire Exit Hardware.
- Panic model includes manual flat key dogging.
- Available configurations include:
  - » with Latch Monitoring switch (ELM)
  - » with Signal Switch (ELS)
  - » with Request-To-Exit switch (ELR)
  - » with Request-To-Exit and Latch Monitoring switches (ELX)

*See installation instructions for wiring diagrams.*

### Solenoid Specifications:

- Current (In Rush - 0.3 seconds): 24VDC, 16 A
- Current (Continuous): 24VDC, 0.25 A

### Availability:

- For all DX2 Exit Devices.

### To order:

- See How To Order, p. 30.



# Electrified



SS

## Signal Switch

Uses a micro switch built into the exit device to monitor the push bar assembly of the device. When pressed, the exit device will sound an alarm and send a signal to any other connected device or system.

The keyed mortise cylinder activates or deactivates the signal switch function. Mortise cylinder is a standard  $1\frac{1}{32}$ " (29.4mm) diameter cylinder,  $1\frac{1}{4}$ " (31.7 mm) long, with a straight cam (DXACA) - refer to page 23 for details.

A power supply and wire transfer are required (sold separately).

**EMERGENCY EXIT** • **SORTIE DE SECOURS**  
PUSH TO OPEN & SOUND ALARM    PUSSEZ POUR OUVRIR ET SONNER L'ALARME

Push bar label.

### Features:

- cULus Listed for Panic and Fire Exit Hardware.
- Keyed mortise cylinder not included, see p. 23.
- Push bar label included.

*See installation instructions for wiring diagrams.*

### Specifications:

- Switch Rate: 24VDC, 2A (per switch)  
(SPDT – Single Pole, Double Throw)

### Availability:

- For all DX2 Exit Devices.

### To order:

- See How To Order, p.30.





# Electrified

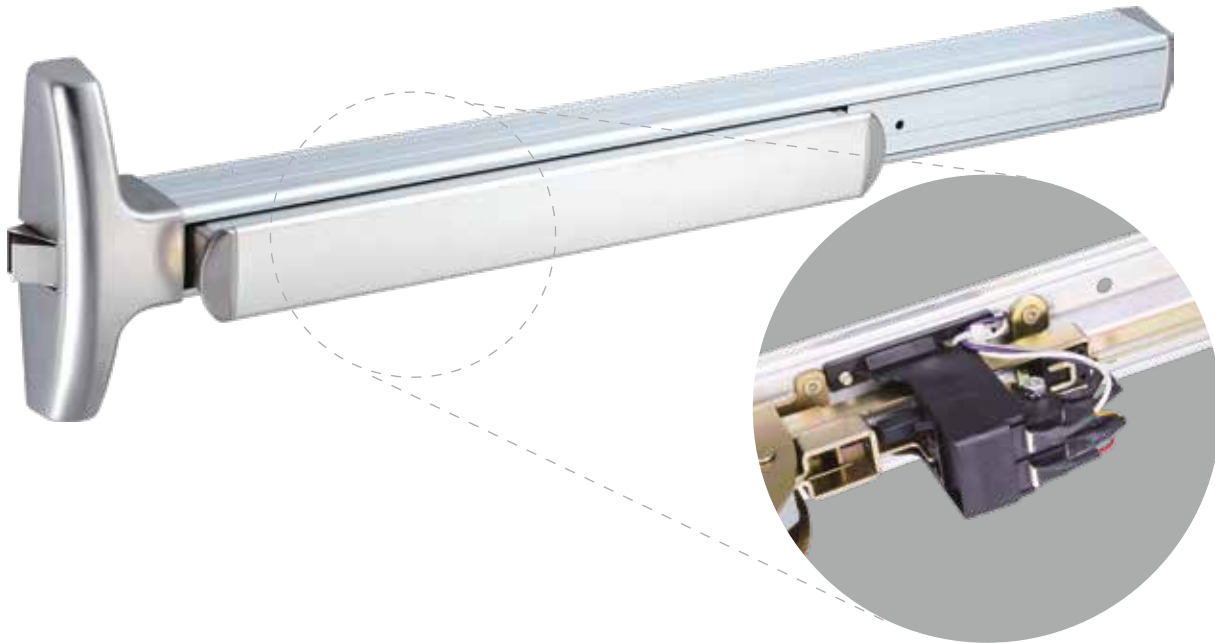

## RX

### Request to Exit

Uses a micro switch built into the exit device to monitor the push bar assembly of the device. When pressed, the exit device will send a signal to a centralized system, electric strike, electromagnetic lock, or other connected electrified device requiring a Request-To-Exit input.

A power supply and wire transfer are required (sold separately).

Request-to-Exit with Latch Monitoring switch (RXM) also available.

#### Features:

- cULus Listed for Panic and Fire Exit Hardware.

See installation instructions for wiring diagrams.

#### Specifications:

- Switch Rate: 24VDC, 3A  
(SPDT – Single Pole, Double Throw)

#### Availability:

- For all DX2 Exit Devices.

#### To order:

- See How To Order, p. 30.



## LM

### Latchbolt Monitoring

Uses a micro switch built into the exit device to monitor the latchbolt of the device. When pressed or released, the monitor switch will send a signal to a centralized system, electric strike, electromagnetic lock, or other connected electrified device requiring an input.

A power supply and wire transfer are required (sold separately).

#### Features:

- cULus Listed for Panic and Fire Exit Hardware.

See installation instructions for wiring diagrams.

#### Specifications:

- Switch Rate: 24VDC, 3A  
(SPDT – Single Pole, Double Throw)

#### Availability:

- For all DX2 Exit Devices.

#### To order:

- See How To Order, p. 30.



# Electrified



## DE

### Delayed Egress Device

DX2 exit devices that are installed with the delayed egress (DE) function are used when an emergency exit needs to be delayed for a short time. This is usually done to allow security personnel to verify if the person attempting to exit should be using that exit or not.

When someone pushes against the push bar, a signal will be sent to a connected security system or device, an alarm will sound, and a timer will begin to countdown from 15 (or 30) seconds. After the time has expired the device will allow passage through the opening.

The keyed mortise cylinder activates/deactivates or rearms the DE function. Cylinder is not included, sold separately. Refer to page 23 for details.

A power supply and wire transfer are required (sold separately).

**Operation Example:** When locked, the exit device LED indicator is on. Depressing the push bar by accident, for less than the nuisance delay time, will sound the audio alarm without initiating the alarm sequence. Depressing the push bar with less than 15 pounds pressure, for longer than the nuisance delay time, will initiate an irreversible local audible beeping tone and the LED indicator will flash until the device releases. After the 15 second delay time, the lock releases and the alarm changes to a steady tone which continues to sound until reset. The remote monitoring contact output on the device can be used to alert security personnel.

#### Features:

- ULus Listed for Panic and Fire Exit Hardware (US only).
- Nuisance delay to prevent accidental activation.
- LED lock status light.
- Keyed mortise cylinder not included, see p. 23.
- Door label (15 seconds) included.
- 30 Second delay model available (DE3).

See installation instructions for wiring diagrams.

#### Specifications:

- Current (In Rush): 24VDC, 16A, 0.3 seconds
- Current (Continuous): 24VDC, 0.37A

#### Availability:

- For all DX2 Exit Devices.

#### To order:

- See How To Order, p. 30.



**PUSH UNTIL ALARM**  
DOOR CAN OPEN IN 15 SECONDS  
**POUSSER JUSQU'À L'ALARME**  
PORTE PEUT OUVRIR EN 15 SECONDES

Door label.

# How To Order

## EXIT DEVICE

DX	2	AL	P	V	L	37	C	-	630	H	
SERIES	STYLE	ELECTRIC	RATING	TYPE	ROD/LATCH	SIZE	DOGGING		FINISH	STRIKE	
BLANK = NOT REQUIRED (IE: DUMMY) <b>1 - WIDE HEAD, SMOOTH SURFACE</b> G1 - WIDE HEAD, GROOVED SURFACE* SEE P.4						3 - 3FT DEVICE 4 - 4FT DEVICE 37 - 3FT DEVICE, 7FT DOOR* 48 - 4FT DEVICE, 8FT DOOR* FOR TALLER DOORS SEE P.22					
BLANK = NOT REQUIRED AL - ALARM EXIT (RX)* AM - ALARM EXIT (LM)* AX - ALARM EXIT (LM+RX)* ALA - ALARM EXIT (RX) AUTO-RESET* AMA - ALARM EXIT (LM) AUTO-RESET* AXA - ALARM EXIT (LM+RX) AUTO-RESET* DE - DELAYED EGRESS (15 SEC)* DE3 - DELAYED EGRESS (30 SEC)* EL - ELEC. LATCH RETRACTION* ELR - ELEC. LATCH RET. (+RX)* ELS - ELEC. LATCH RET. (+SS)* ELM - ELEC. LATCH RET. (+LM)* ELX - ELEC. LATCH RET. (+LM+RX)* LM - LATCHBOLT MONITORING* RX - REQUEST TO EXIT* RXM - REQUEST TO EXIT (+LM)* SS - SIGNAL SWITCH* SEE P.25-29		<b>P - PANIC EXIT</b> <b>F - FIRE EXIT</b>		<b>R - RIM</b> <b>V - SURFACE VERTICAL ROD*</b> <b>C - CONCEALED VERTICAL ROD</b> <b>W - 3 POINT*</b> <b>D - DUMMY, INACTIVE*</b> <b>DA - DUMMY, ACTIVE*</b> SEE P.7-10		BLANK = (PANIC DEFAULT) HEX KEY DOGGING (FIRE DEFAULT) LESS DOGGING <b>C - CYLINDER DOGGING*</b> (CYLINDER NOT INCLUDED) <b>L - LESS DOGGING*</b>		BLANK = DEVICE DEFAULT (SEE P.7-11) <b>A - DXA106</b> <b>B - DXA108</b> <b>C - DXA136*</b> <b>P - DXA203*</b> <b>D - DXA215*</b> SEE P.19-20		<b>E - DXA216</b> <b>F - DXA224*</b> <b>G - DXA225*</b> <b>H - DXA226*</b> <b>J - DXA227/227F</b>	
				BLANK = NOT REQUIRED OR DEFAULT (PULLMAN LATCH) <b>L - LESS BOTTOM ROD*</b> <b>R - ROUND BOTTOM LATCH*</b>		<b>630 - SATIN STAINLESS STEEL (32D)</b> 626 - SATIN CHROME (26D)* 625 - POLISHED CHROME (26)* 613 - OIL RUBBED BRONZE (10B)* 612 - SATIN BRONZE (10)* 611 - POLISHED BRONZE (9)* 606 - SATIN BRASS (4)* 605 - POLISHED BRASS (3)* SEE P.4					

## DEVICE TRIM

DX	2	TE	R	A	09	RHR	SC	KD	6	-	630
SERIES	STYLE	TRIM	DEVICE	DESIGN	FUNCTION	HANDING	KEYWAY	KEYING	PINS		FINISH
<b>1 - NARROW STILE DEVICE</b>								BLANK = NOT REQ. 5 - 5 PINS* <b>6 - 6 PINS</b> 7 - 7 PINS*			
TP - PULL TRIM* <b>TE - ESCUTCHEON TRIM</b> SEE P.14-17 (1) SPECIFY HANDING		<b>R - RIM, VERTICAL OR 3-POINT</b>						BLANK = NOT REQUIRED <b>KD - KEYED DIFFERENT</b> <b>KA - KEYED ALIKE*</b> <b>KA2 - KEYED ALIKE, PAIR*</b>			
BLANK = DEFAULT STYLE <b>K - PULL GRIP K*</b> <b>Q - ESCUTCHEON LEVER Q*</b> <b>A - ESCUTCHEON LEVER A*</b> <b>K - ESCUTCHEON LEVER K*</b> SEE P.14-17				01 - TP / BLANK PLATE* 02 - TP / DUMMY* 03 - TP / NIGHT LATCH* 02 - TE / DUMMY (LEVER)* 03 - TE / NIGHT LATCH* <b>08 - TE / CLASSROOM (LEVER)</b> <b>09 - TE / NIGHT LATCH (LEVER)</b> 14 - TE / PASSAGE (LEVER)* 11 - TE / STOREROOM (THUMB TURN)* 12 - TE / NIGHT LATCH (THUMB TURN)* 16 - TE / PASSAGE (THUMB TURN)* SEE PAGES 14-17		BLANK = NOT REQUIRED <b>SC - SCHLAGE C</b> <b>IA - SFIC A*</b> <b>IAZB - SFIC A, 0-BITTED*</b> <b>IALC - SFIC A, LESS CORE*</b> SEE P.23		RIGHT HAND REVERSED (RHR) BY DEFAULT <b>INDICATE (RHR) OR (LHR) FOR THE PULL TRIM (TP)</b>		BLANK = NOT REQUIRED <b>630 - SATIN STAINLESS STEEL (32D)*</b> <b>626 - SATIN CHROME (26D)</b> 625 - POLISHED CHROME (26)* 613 - OIL RUBBED BRONZE (10B)* 612 - SATIN BRONZE (10)* 611 - POLISHED BRONZE (9)* 606 - SATIN BRASS (4)* 605 - POLISHED BRASS (3)* SEE P.4	

\* SPECIAL ORDER - WILL REQUIRE ADDITIONAL LEAD TIME AND/OR MINIMUM ORDER QUANTITIES.



**CAUTION:** Any retrofit or other field modification to a fire-rated opening can potentially impact the fire rating of the opening, DOREX makes no representations or warranties concerning what such impact may be in any specific situation. When retrofitting any portion of an existing fire rated opening, or specifying and installing a new fire-rated opening, please consult with a code specialist or local code official (Authority having jurisdiction) to ensure compliance with all applicable codes and ratings.

It is important that only DX2 strikes and latches be used with DX2 exit devices. The use of third party or previously installed strikes is not recommended and may hamper performance and/or invalidate hardware certifications. As above, please consult with a code specialist or local code official (Authority having jurisdiction) to ensure compliance with all applicable codes and ratings.

**DOREX<sup>®</sup>**

